



HAL
open science

Ray Launching Modeling in Curved Tunnels with Rectangular or Non Rectangular Section

Emilie Masson, Pierre Combeau, Yann Cocheril, Lilian Aveneau, Marion Berbineau, Rodolphe Vauzelle

► **To cite this version:**

Emilie Masson, Pierre Combeau, Yann Cocheril, Lilian Aveneau, Marion Berbineau, et al.. Ray Launching Modeling in Curved Tunnels with Rectangular or Non Rectangular Section. Ray Launching Modeling in Curved Tunnels with Rectangular or Non Rectangular Section, InTech, pp.239-260, 2012. hal-00985660

HAL Id: hal-00985660

<https://hal.science/hal-00985660>

Submitted on 30 Apr 2014

HAL is a multi-disciplinary open access archive for the deposit and dissemination of scientific research documents, whether they are published or not. The documents may come from teaching and research institutions in France or abroad, or from public or private research centers.

L'archive ouverte pluridisciplinaire **HAL**, est destinée au dépôt et à la diffusion de documents scientifiques de niveau recherche, publiés ou non, émanant des établissements d'enseignement et de recherche français ou étrangers, des laboratoires publics ou privés.

Ray Launching Modeling in Curved Tunnels with Rectangular or Non Rectangular Section

Émilie Masson, Pierre Combeau, Yann Cocheril,
Lilian Aveneau, Marion Berbineau and Rodolphe Vauzelle

Additional information is available at the end of the chapter

<http://dx.doi.org/10.5772/51881>

1. Introduction

Since several years, digital wireless transmissions are experiencing a significant increase with the development of digital TV, satellite communications, mobile phones, internet, wireless local area networks and automation in various domains. The transportation field as a whole is a major actor of these changes. Technologies and systems for wireless communications are increasingly used in the field of guided transport (underground, conventional trains, high speed trains, tramways, *etc.*) to ensure communications between trains and between a train and the infrastructure. These systems answer the key operational needs for safety and comfort, such as control and command of the trains, traffic management, maintenance, security and information for passengers and crew members. We can distinguish two main families of systems: low-data rate reliable transmissions, for traffic control and command, and robust high data rate transmissions, for video surveillance, remote diagnostic or embedded multimedia applications. Consequently, the radio coverage prediction of these wireless systems is mandatory to optimize the deployment of the radio access points in order to ensure the robustness and reliability of radio links and to minimize the antennas positioning phase duration. Indeed, minimum field strengths are generally required to ensure Key Performance Indicators (KPI) related to the requirements of dependability and Quality of Service (QoS).

For underground applications, these systems operate in complex environments, such as tunnels, where the usual laws for predicting the propagation in free space are no longer valid. Like the telecommunication operators, railway manufacturers or guided transport operators should invest in planning tools to deploy their radio communication systems. However, to our knowledge, no general model for predicting free propagation in tunnel exists, as easy to use as well known existing models in the world of mobile phones, such as

statistical models derived from Okumura-Hata, Cost231, *etc.* The tunnel case is usually solved with heavy measurement campaigns that are time consuming and costly. Thus, the development of specific and efficient propagation models for tunnels is very relevant for railway industry to allow both fast responses to tenders, and quick deployments of their wireless communication systems in these specific environments. The tunnels can be rectangular, circular or arch-shaped. In addition, they may be straight or curved, with only one or two tracks.

Several methods to model radio wave propagation in tunnels have been published in the literature and will be presented in this chapter with their advantages and drawbacks. Among them, only few works are dedicated to non rectangular cross section and curved tunnels. Hence, we focus on a new method recently developed. The structure of the chapter is as follows. Section 2 presents the context of the works and why deployments of wireless telecommunication systems are needed for transport applications. Existing techniques to model radio wave propagation in tunnel are presented in section 3 with their respective advantages and drawbacks. The fourth and fifth sections are respectively devoted to the design and the evaluation of a propagation prediction model for curved tunnel with a rectangular or a circular cross section. Finally, section 6 concludes and presents some perspectives to these works.

2. Wireless telecommunication systems needs for transport applications

The growing of wireless networks including cellular (GSM, GPRS, EDGE, UMTS, *etc.*) saw the arrival on the market of a number of software tools dedicated to radio systems planning, for industrial and telecom operators. These tools allow the identification of sites to set up base stations from the definition of the characteristics of areas to cover, possibly by imposing the location of some sites (favorite sites). Most of these tools are very heavy to handle, dedicated to radio engineers, optimized and enriched by in-house phone operators to take into account the different propagation environments encountered.

Like the general public telecommunications world, the widespread use of wireless communication systems in the field of transport requires the use of software tools for planning and optimization for the efficient deployment of these systems. Some existing tools in the world of telecommunications are specifically adapted, for example for the deployment of GSM-R infrastructures in various European countries. But to our knowledge, no module specifically dedicated to the metro tunnels is currently sold.

Thus, in most cases, the industrials perform measurement campaigns that are time consuming and costly. These experimentations require free access to the operational sites, which is a difficult task to achieve:

- In the case of a line under construction, site access depends on the progress of the construction that may experiences significant delays. Indeed, the development of a wireless communication system is the final step of the overall transportation system;

- In the case of a line already in operation, access to the site has to be done outside the hours of operation of the metro, which leads to very short ranges that occur most often during night.

To limit the measurement campaigns, it is necessary that the railway industrials possess planning tools to determine the field strength regardless of the environment encountered: consideration of tunnels with different cross and longitudinal sections and building materials for example. Propagation models must meet the best compromise between accuracy and computation time and have to be simple to use.

For outdoor areas, predictive models of the radio coverage are the well-known statistical models, such as free space attenuation, Okumura-Hata model or 2-rays model. These models work well because the deployment is in Line-Of-Sight (LOS) and distances between transmitter and receiver are weak. The measurement campaigns are easy to implement and generally there are few constraints for the positioning of access points that are most often located on existing poles (signaling, lighting, *etc.*).

In tunnel areas, the prediction of radio coverage is currently based on intensive use of feedback on measurements and implementation of engineering rules.

Configurations of complex tunnels, such as curved tunnels of circular cross section are more frequently encountered in the modern metro lines and it becomes necessary to refine the prediction process of the radio coverage for deployment based on more sophisticated tools, such as the method presented in this chapter.

3. Existing techniques to model radio wave propagation in tunnel

Methods based on simulation and measurement of radio wave propagation in tunnels were presented in the literature. Analyses based on measurements at 900 MHz and 1800 MHz represent the first approach (Hwang et al., 1998), (Zhang & Hwang, 1998a), (Zhang et. al, 1998), (Zhang & Hong, 2004), in order to characterize propagation in wide rectangular tunnels. In (Zhang & Hwang, 1998b), (Lienard & Degauque, 1998), statistical characteristics of propagation channel in tunnels are performed from measurement results. However, analyses performed from the measurements presented in these papers are specific to a given shape of tunnel. Radio wave propagation modeling in generic tunnels is thus a major research field.

Some authors have proposed methods based on the modal theory to provide all the modes propagating in tunnel. Approximate and exact solutions have been determined for straight rectangular tunnels and straight circular tunnels respectively (Laakman & Steier, 1976), (Emslie et al., 1975), (Mahmoud, 1974), (Dudley & Mahmoud, 2006), (Dudley et al., 2007). The modal theory considers tunnels as oversized waveguides. It provides good results but it is limited to canonical geometries, which are not the main cases according to the generally encountered tunnels.

Several papers present results based on an exact resolution of Maxwell's equations using numerical techniques such as integral methods or the resolution of the Vector Parabolic Equation (Chang et al., 2009), (Reutskiy, 2008), (Popov, 2000), (Bernardi et al., 2009). One more time, these kinds of techniques are limited, mostly due to the computational complexity. Indeed, these methods are based on a volume discretization of the propagation environment with a scale that should be smaller than the wavelength. Consequently, the complexity is prohibitive for operational environments.

Finally, frequency asymptotic techniques based on the ray concept, being able to handle complex tunnel geometries in a reasonable computation time, seem to be a good solution. A first simple approach based on a 2-rays model was proposed in (Zhang, 2003), (Ahmed et al., 2008). This method suffers from lack of accuracy due to approximations on the number of rays considered in the model. In (Mahmoud, 1974), a model based on a Ray Tracing, based on image method, takes into account multiple reflections, but only for the case of straight rectangular tunnels. In (Mariage et al., 1994), the authors use this method and adds diffraction phenomenon in order to analyze the coupling between indoor and outdoor. In (Agunaou et al., 1998), works are purchased by considering changes of tunnel sections, but still only in straight rectangular tunnels. However, tunnels in real environments, such as metro ones, can have non rectangular cross section. Furthermore, they can be curved. Ray Tracing is no longer valid with curved surfaces since the source image is no more unique. Consequently, only a few studies deal with the case of non-rectangular cross sections and curved tunnels.

The first intuitive approach for curved surfaces consists of a tessellation of the curved geometry into multiple planar facets, as proposed in (Chen & Jeng, 1996), (Torres et al., 1999), (Baranowski et al., 1998), (Masson et al., 2010). Unfortunately, the surface curvature is not taken into account in this type of techniques. Furthermore, one of the major drawbacks of this approach is the impossibility to identify an optimal number of facets for a given tunnel cross section and a given frequency (Masson et al., 2010). In (Wang & Yang, 2006), a ray-tube tracing method is used to simulate wave propagating in curved road tunnels. An analytical representation of curved surfaces is proposed. Comparisons with measurement results are performed in straight arch-shaped and curved tunnels. The paper lacks of information. Consequently, we focused on the works presented in (Didascalou et al., 2000), (Didascalou et al., 2001). A Ray Launching combined with a ray-density normalization is presented. The surface curvature is taken into account. Comparisons with measurements are performed respectively in a scaled tunnel (with 20 cm reduced diameter dimension, and then higher frequency at 120 GHz for compensating the former), and in curved subway tunnels at 900 MHz and 1800 MHz. The method provides good results but exhibits two main defaults: the geometric shapes of the tunnels are not all flexible, and the computation time is high due to the large number of rays launched at transmission. To overcome these drawbacks, we developed a method to model the electromagnetic propagation in tunnels with curved geometry, either for the cross section or the main direction. The main advantage of this new method is its best compromise between accuracy and computation time for applications at 5.8 GHz. It is presented in the next section.

4. Design of a propagation prediction model for non rectangular cross section and curved tunnels

The aim of the developed method is to model radio wave propagation in non rectangular cross section and curved tunnels. The problem to be solved consists in taking into account the presence of curved surfaces which induces divergence of rays by reflection on surfaces. An adaptation of the Ray Launching technique and a correction on paths trajectories have to be performed.

The method consists of three main steps. First step consists of an adaptation of a classical Ray Launching technique for the consideration of curved surfaces. Developments on emission, reception and intersection between rays and curved surfaces are performed. Second step is to correct the received paths trajectories after the Ray Launching step. It consists of a minimization of the paths length, a choice of optimized paths and an adapted algorithm for the Identification of Multiple Rays (IMR). Last step consists in taking into account the divergence of rays for the Electric Field calculation in the presence of curved surfaces.

We consider four kinds of tunnel geometry encountered in operational cases, illustrated in Figure 1:

- the straight rectangular tunnel;
- the straight circular tunnel;
- the curved rectangular tunnel;
- the curved circular tunnel.

For tunnels with circular cross section, a floor and/or a roof can be added in the model of the environment to take into account arch-shaped sections for example. All these configurations lead us to consider three kinds of elementary geometry: The plane for the straight rectangular tunnel and the additional floor/roof, the cylinder for the straight circular tunnel and the walls of the curved rectangular one, and finally the torus according to the curved circular tunnel. All these components are quadrics, which is important for the simplicity of intersection computation with rays.

4.1. Ray launching for curved surfaces

4.1.1. Emission

Since *no a priori* information on privileged propagation direction is available, we chose to implement a Ray Launching technique based on a uniform distribution of rays radiated from the transmitter. There are different techniques to obtain a uniform distribution.

We consider a stochastic Monte Carlo method (Didascalou et al., 2000) in order not to skew the results. Instead of using random sequences, the method consists in using quasi-random sequences (Morokoff & Caflisch, 1995) to regularly cover all the space. Indeed, quasi-random sequences allow minimizing the discrepancy, which corresponds to a measure of the gap between a reference situation, generally perfect uniformity, and a given configuration.

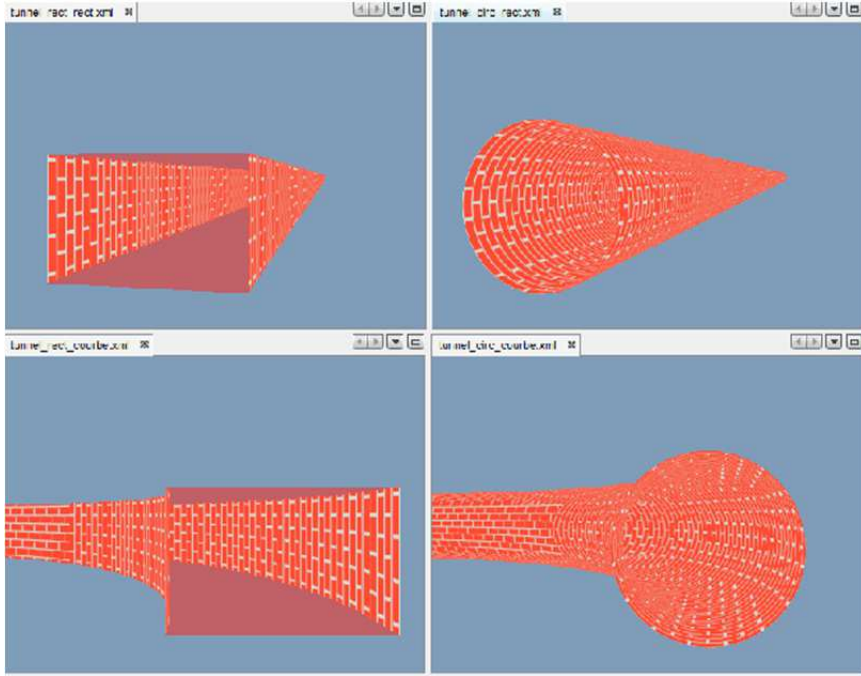

Figure 1. Four kinds of treated tunnels

Figure 2 illustrates the distribution of 512 rays computed from a random sequence compared to ones obtained from two quasi-random sequences, namely Halton (Halton, 1960) and Hammersley (Hammersley, 1964). The Hammersley sequence allows us to obtain the best uniform distribution.

In order to prove it, we present in Figure 3 the histogram of the angles between each ray and its nearest neighbor. So, the most uniform sequence is the one which provides the highest peak for a given angle value in its histogram, it will then minimize the discrepancy. It appears again that the best one is the Hammersley sequence. Therefore, we chose to use it to trace the rays radiated from the transmitter.

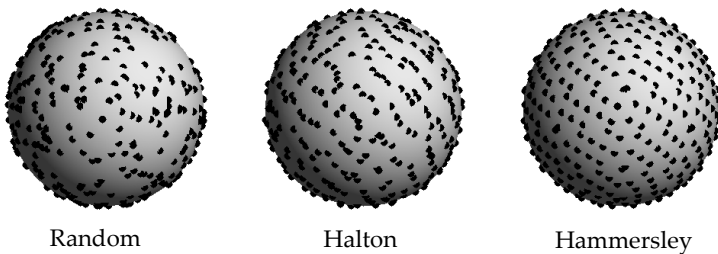

Figure 2. Comparison of the distribution of 512 rays at transmission between the use of a random sequence and 2 quasi-random sequences: Halton and Hammersley

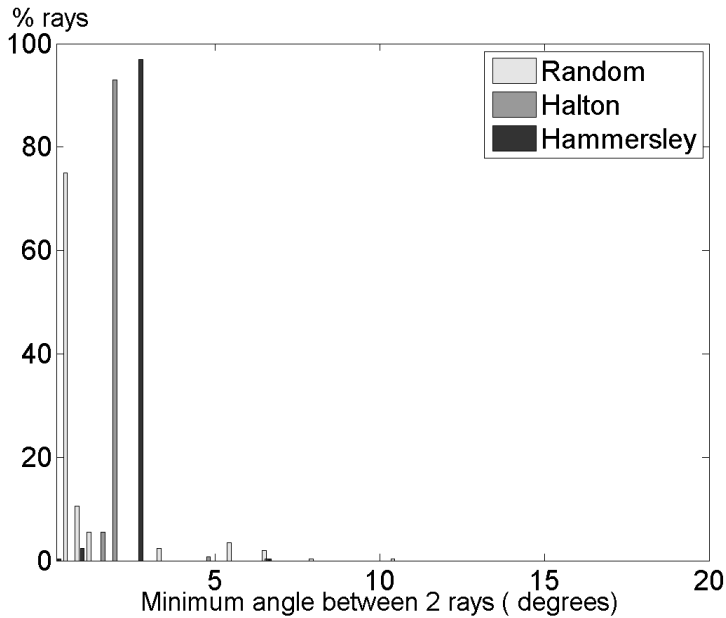

Figure 3. Histogram of minimum angles between two rays launched at transmission

4.1.2. Reception

The Ray Launching technique requires a reception sphere to determine which rays contribute to the received power. Indeed, the probability that a given ray meets a receiver point is always zero. The reception sphere radius, denoted as r_R , depends on the path length r and the transmission angle γ (Seidl & Rappaport, 1994):

$$r_R = \frac{\gamma r}{\sqrt{3}} \quad (1)$$

The main drawback of a reception sphere is that it should receive a collection of rays whereas an only one is predicted by Geometrical Optics. These rays are called multiple rays, as illustrated in Figure 4. If all of them are added together the result will be an overestimation of the received power. Thus, it is necessary to discriminate them. This can be performed with an Identification of Multiple Rays (IMR) algorithm (Iskander & Yun, 2002). Classical criteria include the number of reflections, the path length and the transmission angle. In case of curved surfaces, multiple rays are much more scattered and distant from each other. A specific treatment of the rays and an adapted IMR are so needed and proposed in section 4.2.

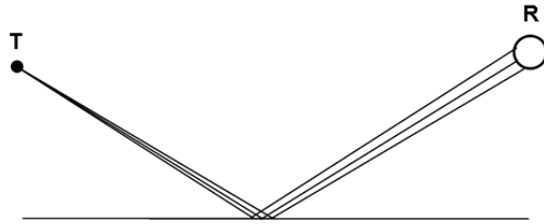

Figure 4. Illustration of multiple rays by using a reception sphere

4.1.3. Intersection ray/curved surface

We have shown that besides planar surfaces, both cylindrical and toroidal surfaces have to be taken into account in the considered tunnel configurations. These geometrical objects belong to the quadrics family and can thus be easily expressed in an analytical form.

In Cartesian coordinates, the equation of a cylinder with the axial direction along the y-axis and centered at the origin is given by:

$$x^2 + z^2 = r_c^2 \tag{2}$$

with r_c the radius of the cylinder.

In a same way, the equation of a torus around the z-axis and centered at the origin is as follows:

$$(x^2 + y^2 + z^2 + R_t^2 - r_t^2)^2 - 4R_t^2(x^2 + y^2) = 0 \tag{3}$$

with R_t and r_t the radiuses of the torus.

The definition of a ray being as follows:

$$\begin{aligned} x &= d_x + t \cdot di_x, \\ y &= d_y + t \cdot di_y, \\ z &= d_z + t \cdot di_z \end{aligned} \tag{4}$$

with (d_x, d_y, d_z) the origin of the ray and (di_x, di_y, di_z) the direction vector of the ray, the intersection of a ray with a cylinder and a torus leads to the resolution of respectively, a quadratic equation and an equation of degree 4.

4.2. Optimized IMR and final choice of corrected rays

The section 4.1.2 has shown that using a reception sphere leads to take multiple rays into account. The multiple rays are determined by classical IMR algorithms based on similarity criterion according to geometrical characteristics of the rays. Then, the choice of the retained

ray is randomly realized among the identified multiple rays, without any physical considerations. So, they lead to a bad approximation of the real ray. To enhance this approach, we propose here to add a correction algorithm of the trajectories of multiple rays that makes them converge to the correct geometrical one. The ambiguous choice of the ray for a correct field calculation is thus avoided.

4.2.1. Correction algorithm of the paths trajectories

The general principle is as follows. Once a ray is launched from the transmitter using the Hammersley quasi-random sequence, its propagation is recursively computed, by calculating its intersection with the curved surfaces, until it reaches the reception sphere. Either it undergoes the fixed maximum number of reflections, or it goes outside the tunnel. So, a contributive ray (a path), *i.e.* one that has reached the reception sphere, presents some geometrical approximations since it does not go through the exact receiver position, as it has been explained in section 4.1.2. Using the Fermat Principle, indicating that the path followed by a wave between two points is always the shortest one, we propose to reduce the geometrical approximation involved in each path: The correction algorithm consists, for a given path, in minimizing its length assuming that it reaches the center of the reception sphere.

While the path length function is not linear, we propose to use the well-known Levenberg-Marquardt algorithm (Marquardt, 1963). Nevertheless, the algorithm is efficient only if the starting point (*i.e.* the initial ray) is near the solution. By using the Ray Launching, it can be assumed that the paths caught by the reception sphere are close to the real paths existing with a Geometrical Optics meaning, *i.e.* the shortest. Thus the received rays represent a good initialization of the algorithm. The principle of the Levenberg-Marquardt algorithm consists in finding the best parameters of a function which minimize the mean square error between the curve to approximate and its estimation.

Applied to propagation in tunnels, the objective becomes a path length minimization. The criterion to minimize is then the total path length J given by:

$$J = \left\| \overline{EP_1} \right\| + \sum_{k=2}^N \left\| \overline{P_{k-1}P_k} \right\| + \left\| \overline{P_N R} \right\| \quad (5)$$

With E the transmitter position, R the receiver position and P_k the k^{th} interaction point position of the considered path, as illustrated in Figure 5.

The vectors defined in (5) depend on the coordinates of the interaction points along the path. The iterative algorithm requires the inversion of a Hessian matrix which contains the partial derivatives of the J criterion to minimize with respect to parameters. To keep computation time and numerical errors reasonable, the matrix dimensions and thus the number of parameters have to be minimized. Local parametric coordinates (u, v) from the given curved surface are used instead of global Cartesian coordinates (x, y, z) . The parameters vector θ can be written as:

$$\theta = [u_1 v_1 \dots u_N v_N] \tag{6}$$

Where (u_k, v_k) correspond to coordinates of the reflection point P_k .

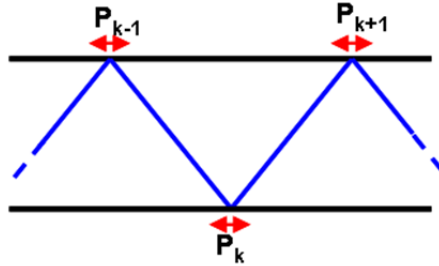

Figure 5. Principle of optimization of paths

4.2.2. Validation of corrected trajectories

Since the Levenberg-Marquardt algorithm is a numerical method, its convergence cannot be guaranteed. So, we have to proceed to a validation test on the corrected paths, which can be incoherent in the case of an algorithm divergence.

This test consists in checking if the Geometrical Optics laws are respected, specifically the Snell-Descartes ones. For each reflection point, we verify if the angle of reflection θ_r equals the angle of incidence θ_i , as illustrated in Figure 6. If not, the path is discarded. For instance an unphysical path $\vec{d}_{r_{LM}}$ computed by the Levenberg-Marquardt algorithm different from $\vec{d}_{r_{ok}}$ (by considering $\theta = \theta_r$) is shown in figure 6. The path $\vec{d}_{r_{LM}}$ is thus eliminated.

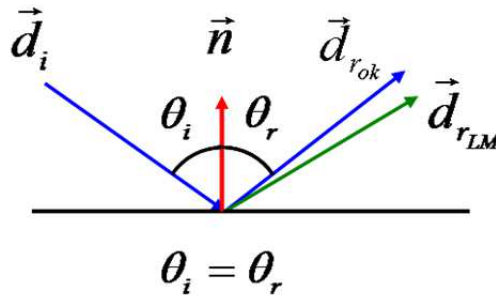

Figure 6. Validation criterion of corrected paths

4.2.3. Final choice of the correct ray

Section 4.1.2 indicates that the Ray Launching algorithm leads to the existence of multiple rays corresponding to the same contribution according to Geometrical Optics. They must be identified and only one ray has to be kept. However, the correction technique previously

presented allows obtaining multiple rays very close to the real path, and consequently very close to each other. Nevertheless, due to numerical errors, they cannot be strictly equal to each other. Thus, the choice of the final ray can be done on the base of the reflection points localization: If the reflection points of two candidate paths are at a given maximal inter-distance, the paths are considered to be equal and one of the two is removed, it does not matter which.

4.3. Electric field calculation

In the case of a curved surface, Electric Field can be computed after reflection by classical methods of Geometrical Optics as long as the curvature radiuses of surfaces are large compared to the wavelength (Balanis, 1989).

It can be expressed as follows (Figure 7):

$$\overline{E^r}(P) = \sqrt{\frac{\rho_1^r \rho_2^r}{(\rho_1^r + r)(\rho_2^r + r)}} e^{-jk r} \overline{\overline{R E^i}}(Q) \quad (7)$$

With ρ_1^r and ρ_2^r the curvature radiuses of the reflected ray, r the distance between the considered point P and the reflection point Q , $k=2\pi/\lambda$ with λ the wavelength, and R the matrix of dyadic reflection coefficients.

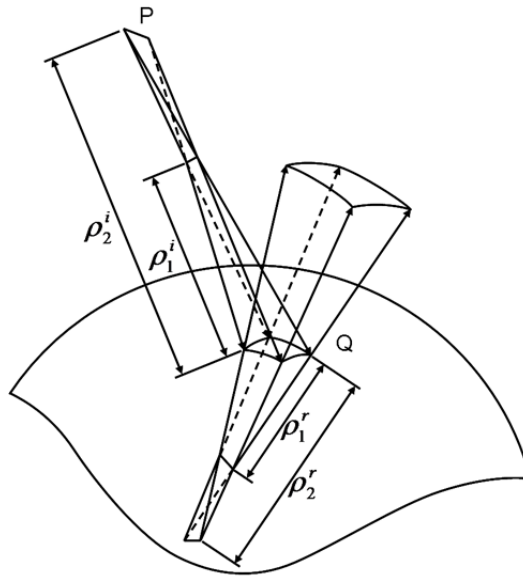

Figure 7. Reflection on a curved surface

Unlike the case of planar surfaces, the curvature radiuses of the reflected ray are different from those of the incident ray. Indeed, the following relation holds (Balanis, 1989):

$$\frac{1}{\rho_{1,2}^r} = \frac{1}{2} \left(\frac{1}{\rho_1^i} + \frac{1}{\rho_2^i} \right) + \frac{1}{f_{1,2}} \quad (8)$$

With ρ_1^i and ρ_2^i the curvature radiuses of the incident ray and $f_{1,2}$ a function depending on ρ_1^i , ρ_2^i and the curvature radiuses $R_{1,2}$ of the curved surface (Balanis, 1989).

5. Performance analysis in curved tunnels

This section is dedicated to the performance analysis of the method presented in section 4 in tunnels presenting non rectangular cross section and/or curved longitudinal section. This evaluation is performed from measurement results obtained in real tunnel environments. Performances are evaluated in narrow band by using a comparison of received narrow band powers. First part of the section is dedicated to analyses in a straight arch-shaped tunnel. Second and third parts of the section focus on rectangular and circular curved tunnels.

5.1. Performance analysis in a straight arch-shaped tunnel

5.1.1. Configuration

Measurements were first performed in a straight arch-shaped tunnel, the tunnel of Roux. It consists of a two-way road tunnel located in Ardèche in France, and is illustrated in Figure 8. The straight section has a length of 3325 m. The arch-shaped cross section has a maximal height and width of 5.8 m and 8.3 m respectively.



Figure 8. Illustration of the Tunnel of Roux

The measurements were performed at 5.8 GHz. The transmitter was located at a fixed position at the center of the section, at a height of 4.8 m. It consists of a horn antenna (10.1 dBi gain at 5.8 GHz), vertically polarized. The receiver was moving along the longitudinal axis of the tunnel thanks to a go-kart allowing a very small and regular velocity, compatible with the acquisition rate. It is illustrated in Figure 9. The receiving antenna was vertically

polarized and had the same characteristics than the transmitting one. It was located in the middle of the two tracks, 2.4 m from the sidewall, at a height of 4.1 m. Figure 10 illustrates the antennas configuration of measurements.

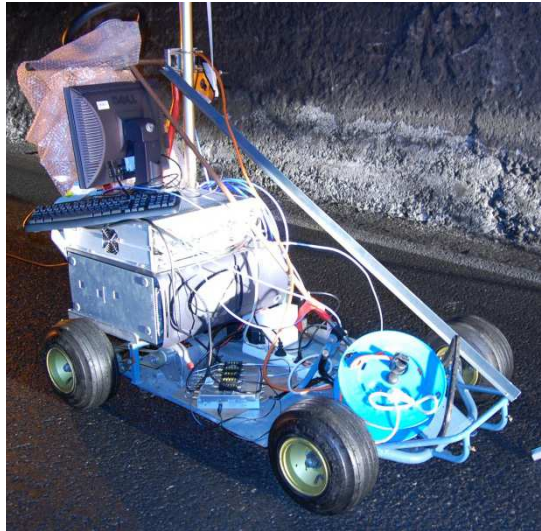

Figure 9. Go-kart used at reception

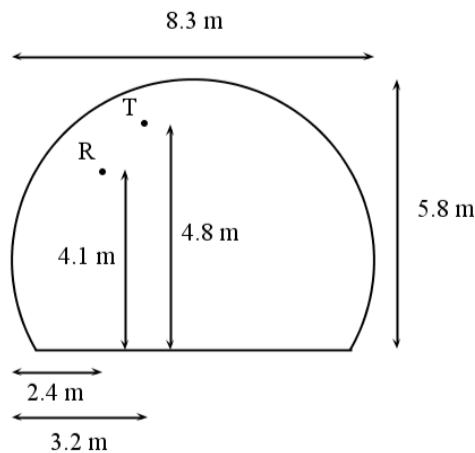

Figure 10. Antennas configuration of measurements in the Tunnel of Roux

5.1.2. Comparison between simulation and measurement loss

Figure 11 presents the comparison between measurements and simulations in terms of normalized received power (P_r) with respect to the transmitted one (P_t), versus the distance between transmitter and receiver along the longitudinal tunnel axis in the Tunnel of Roux.

A quite good concordance between simulations and measurements is highlighted. A detailed analysis is performed in the following.

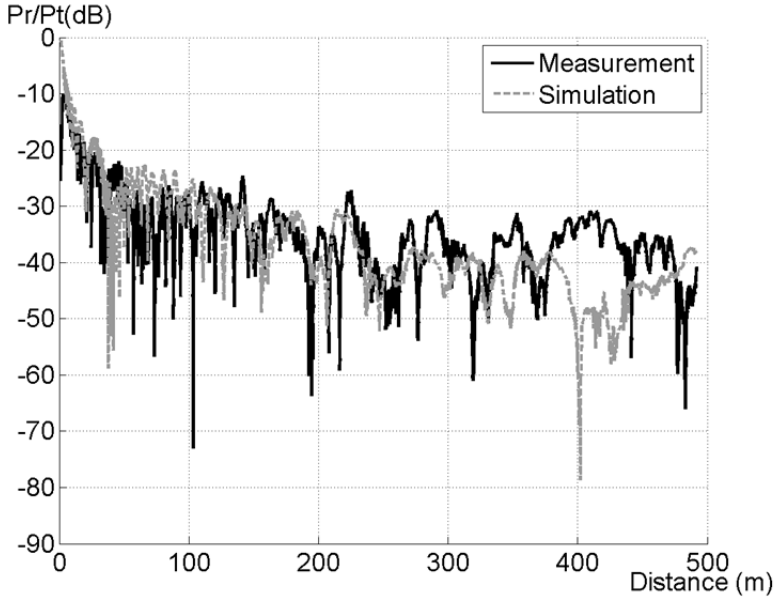

Figure 11. Comparison between measurements and simulations loss in the Tunnel of Roux – 5.8 GHz

5.1.3. Statistical analysis of results

Statistical analysis of slow and fast fading is performed on simulation and measurement results. The procedure to extract these data is as follows. First step consists in smoothing signals by using a running mean. The window's length is 40λ on the first 50 m, and 100λ elsewhere, according to the literature (Lienard & Degauque, 1998).

Then, the analysis of slow fading can be performed by the computation of the mean and standard deviation of the error between measurements and simulations. Results are illustrated in Table 1. The slow fading analysis highlights a good agreement between results both for the mean and the standard deviation. Indeed, the values are in the range of 4/6 dB, which generally, from a practical point of view, illustrates good agreement.

	Mean (dB)	Standard deviation (dB)
5.8 GHz	5.35	6.86

Table 1. Mean and standard deviation (in dB) of the error between simulations and measurements in the Tunnel of Roux – 5.8 GHz

Second step consists of an analysis of fast fading. The data are extracted by the smoothing procedure as above. The Cumulative Density Functions (CDF) are computed from measured

and simulated data and the Kolmogorov-Smirnov (KS) criterion is applied. Comparisons with theoretical distributions of Rayleigh, Rice, Nakagami and Weibull are performed. Results are given in Table 2. It appears that the Weibull distribution better minimizes the KS criterion, for both measurements and simulations. This study is very useful to reproduce statistically fast fading variations in order to realize studies on system performance.

	Measurements	Simulations
Rayleigh	0.22	0.24
Rice	0.22	0.24
Nakagami	0.05	0.06
Weibull	0.03	0.02

Table 2. KS criteria of the simulations and measurements compared to theoretical distributions in the Tunnel of Roux – 5.8 GHz

All the analysis carried out according to measurement and simulation results leads us to a quite good matching between measurements and simulations in terms of slow and fast fading. The developed method provides good performances in a straight arch-shaped tunnel.

Furthermore, it has to be noticed that results presented in this part do not depend on the location in the tunnel, while the cross section is similar. This kind of results can be found in literature (Lienard et al., 2007). On the other hand, position of antennas in the cross section can have a big impact on the received power.

5.2. Performance analysis in curved tunnels

5.2.1. Curved rectangular tunnel

5.2.1.1. Configuration

Measurements were performed in a curved rectangular tunnel by an ALSTOM-TIS team. The measurement procedure is as follows. The transmitter is located on a side near the tunnel wall. It is connected to the radio modem delivering a signal at the required frequency. Two receivers, separated by almost 3 m, are placed on the train roof. They are connected to a radio modem placed in the train. Tools developed by ALSTOM-TIS allow us to carry out field measurements and to take into account a simple spatial diversity by keeping the maximum level of the two receivers. Measurements were performed at 5.8 GHz. The measurements configuration is depicted in Figure 12. The curved rectangular tunnel has a curvature radius equal to 299 m, a width of 8 m and a height of 5 m.

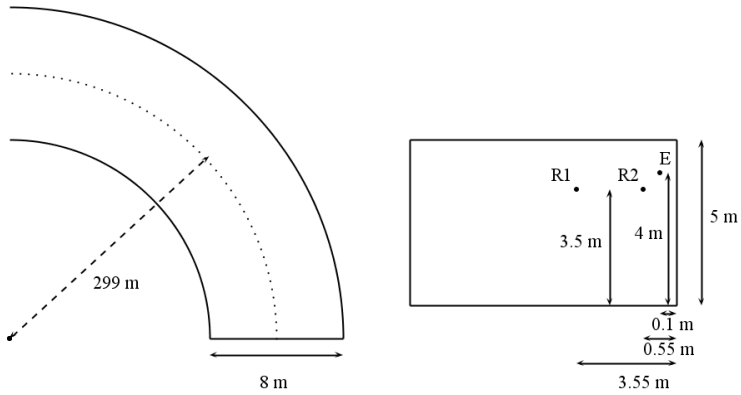

Figure 12. Antennas configuration of measurements in the curved rectangular tunnel

5.2.1.2. Comparison between simulations and measurements

Figure 13 presents the comparison between measurements and simulations in the configuration of Figure 12, in terms of normalized received power (P_r) with respect to the transmitted one (P_t), versus the distance between transmitter and receiver along the longitudinal tunnel axis in the curved rectangular tunnel.

One more time, a quite good concordance between simulations and measurements is highlighted. An analysis is presented below.

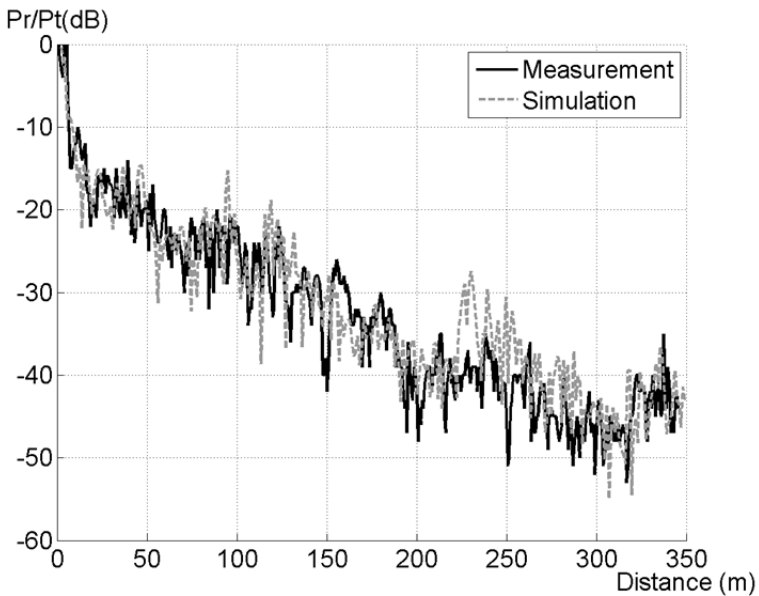

Figure 13. Comparison between measurements and simulations in the curved rectangular tunnel – 5.8 GHz

5.2.1.3. Statistical analysis of results

For these measurements, analysis of fast fading was not possible because of the lake of measured data (spatial sampling greater than $\lambda/2$). We only present a slow fading analysis, as it was performed in the section 5.1.3. Mean and standard deviation values of the error between simulations and measurements are presented in Table 3. It can be observed values around 2 dB which represents a quite good concordance between measurements and simulations in the case of the curved rectangular tunnel.

	Mean (dB)	Standard deviation (dB)
5.8 GHz	2.15	2.55

Table 3. Mean and standard deviation (in dB) of the error between simulations and measurements in the curved rectangular tunnel – 5.8 GHz

5.2.2. Curved circular tunnel

5.2.2.1. Configuration

Measurements were finally performed in a curved circular tunnel. As for the curved rectangular tunnel, the measurements were also realized by an ALSTOM-TIS team. The same measurement procedure was followed. Measurements were performed at 5.8 GHz. The measurements configuration is depicted in Figure 14. The curved circular tunnel has a curvature radius equal to 1000 m and a radius of 2.6 m.

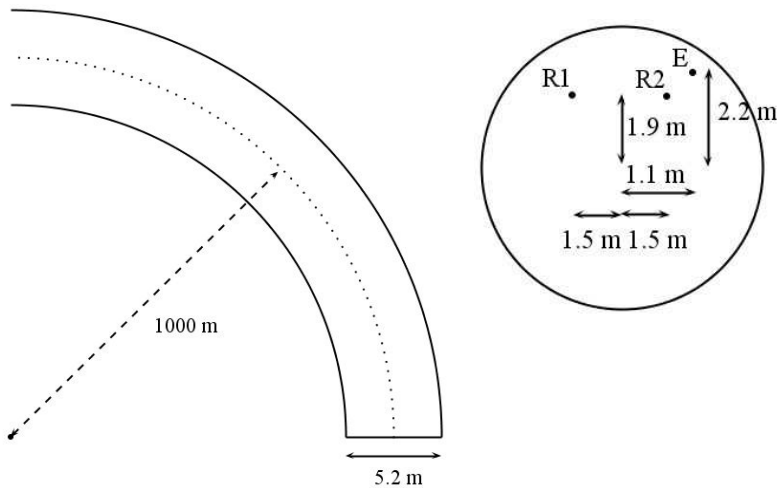

Figure 14. Antennas configuration of measurements in the curved circular tunnel

5.2.2.2. Comparison between simulations and measurements

Figure 15 presents the comparison between measurements and simulations in terms of normalized received power (P_r) with respect to the transmitted one (P_t), versus the distance

between transmitter and receiver along the longitudinal tunnel axis in the curved circular tunnel.

It appears a relative good concordance between simulations and measurements. We analyze these results in the following section.

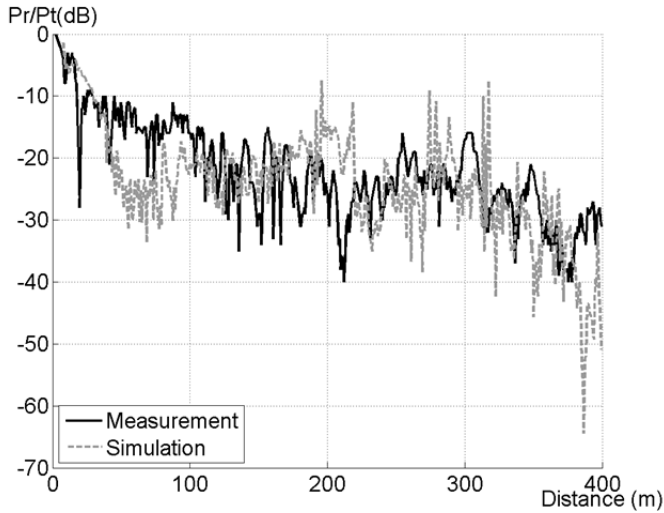

Figure 15. Comparison between measurements and simulations in the curved circular tunnel – 5.8 GHz

5.2.2.3. Statistical analysis of results

As for the curved rectangular tunnel, analysis of fast fading was not performed in this case. Mean and standard deviation values of the error between simulations and measurements are presented in Table 4. It can be observed values around 6 dB which represents a relative good concordance between measurements and simulations in the case of the curved rectangular tunnel. However, some different behaviors can be observed on few areas, such as between 50 and 100 m or 150 and 200 m. These differences are due to problems that can remain in the correction algorithm and lead to a bad estimation of the received power.

	Mean (dB)	Standard deviation (dB)
5.8 GHz	5.35	6.80

Table 4. Mean and standard deviation (in dB) of the error between simulations and measurements in the curved circular tunnel – 5.8 GHz

A global remark can be added for the case of curved tunnels (with rectangular or circular cross section). As for the case of results presented in section 5.1, results are not dependent of the location in the tunnel while the cross section is similar and also while the curvature radius is the same. In this case also, position of antennas in the cross section can have a big impact on the received power.

6. Analysis and discussion

Modeling of radio wave propagation in non rectangular and/or curved tunnels was presented. A first part is dedicated to the presentation of the requirements of wireless telecommunication systems for transport applications. These systems lead to the need for industrial of models to predict radio propagation in particular environments such as tunnels. As presented in details in (Masson, 2010), no such tools are marketed in transport domain and specific tools have to be developed for transport applications in tunnels.

Second part presents the methods to model radio wave propagation in tunnels. Three kinds of models are presented. Methods based on the modal theory provide all the modes propagating in tunnel. These methods provide good results but are limited to canonical geometries, such as rectangular and circular straight tunnels. Some papers are based on the exact resolution of Maxwell's equations. These kinds of techniques are also limited due to the computational complexity. Finally, frequency asymptotic methods based on the ray concept leads to the best compromise between accuracy and computation time. However, tunnels in real environments can have non-rectangular cross section and can also be curved. Only a few studies deal with these cases.

The developed method is presented in the third part where each step of the method is detailed. This one is based on a Ray Launching technique combined with an optimized IMR technique based on a correction of paths trajectories. It consists in a minimization of the total distance of the considered path in order to make it converge to the real one, existing in Geometrical Optics meaning. The technique is based on the well-known Levenberg-Marquardt algorithm. A validation of computed paths after correction is realized by verifying the angles of incidence and reflection. A new IMR algorithm is also developed leading on comparison of reflection points.

Last part is devoted to the evaluation of the method in three different geometries of tunnels: the straight arch-shaped tunnel, the curved rectangular tunnel and the curved circular tunnel. This evaluation is performed from measurements realized in real environments, at 5.8 GHz. For the case of the straight arch-shaped tunnel, a slow fading study was realized and lead to a mean and standard deviation between measurements and simulations of about 5-6 dB, which represents a quite good agreement between simulations and measurements. A fast fading study was also performed. The data were extracted by a smoothing procedure. The CDF were computed from measured and simulated data and the KS criterion was applied. Comparisons with theoretical distributions of Rayleigh, Rice, Nakagami and Weibull were performed. It appeared that the Weibull distribution better minimizes the KS criterion, for both measurements and simulations. This kind of study is very useful to reproduce statistically fast fading variations in order to realize studies on system performance. For the case of curved rectangular and circular tunnels, similar studies on slow fading were realized and lead to a mean and standard deviation between measurements and simulations of about 3-6 dB, which represents a good agreement of results, validating the method.

There exist many perspectives to this work. As it was seen in the previous section, in some areas, bad estimation of the received power is obtained in the case of a curved circular tunnel. These errors can be due to imperfection of correction algorithm that could be improved to obtain reliable results.

Right now, the method is able to treat empty tunnels. The following step will consist in taking into account the presence of trains in the tunnel. The phenomenon of masking train will also be investigated. In this case, diffraction has to be taken into account in the Ray Launching technique. The diffraction phenomenon would also allow taking into account complex geometries such as station, crossing, *etc.*

7. Conclusion

The chapter was dedicated to the radio wave propagation modeling in non rectangular and/or curved tunnels. It was shown that classical methods (modal theory, rigorous methods, asymptotic methods) to model propagation in these kinds of tunnels can not be used. Specific treatments on Ray Launching, based on a correction of paths trajectories, have to be implemented. They were presented, evaluated and discussed.

Author details

Émilie Masson, Yann Cocheril and Marion Berbineau
Univ Lille Nord de France, F-59000, Lille, IFSTAR, LEOST, France

Pierre Combeau, Lilian Aveneau and Rodolphe Vauzelle
XLIM-SIC laboratory, UMR CNRS 7252, University of Poitiers, France

Acknowledgement

The authors would like to thank the ALSTOM-TIS (Transport Information Solution) who supported this work.

8. References

- Agunaou, M.; Belattar, S., Mariage, P. & Degauque, P. Propagation d'ondes électromagnétiques hyperfréquences à l'intérieur d'un métro - Modélisation numérique de l'influence des changements de section. *Recherche Transports Sécurité*, Vol.64, (1998), pp.55-68.
- Ahmed, B. T.; Ramon, M. C. & Ariet, L. H. Comments on the Hybrid Model for Propagation Loss Prediction in Tunnels. *IEEE Antennas and Propagation Magazine*, Vol.45, No.5, (2008), pp.156-158.
- Baranowski, S.; Bourdier, G. & Degauque, P. Optimisation des règles d'ingénierie radio-modélisation de la propagation d'ondes radioélectriques en tunnels courbes. *Convention*

- d'études INRETS/USTL 1997/L1, Laboratoire de Radio propagation et Electronique, Villeneuve d'Ascq, 1998.*
- Bernardi, P., Caratelli, D., Cicchetti, R., Schena, V. & Testa, O. A Numerical Scheme for the Solution of the Vector Parabolic Equation Governing the Radio Wave Propagation in Straight and Curved Rectangular Tunnels. *IEEE Transactions on Antennas and Propagation*, Vol.57, No.10, (2009), pp.3249-3257.
- Chang, H. W.; Wu, Y. H., Lu, S. M., Cheng, W. C. & Sheng, M. H. Field Analysis of Dielectric Waveguide Devices based on Coupled Transverse-mode Integral Equation-Numerical Investigation. *Progress In Electromagnetics Research PIER 97*, (2009), pp.159-176.
- Chen, S. H. & Jeng, S. K. SBR image approach for radio wave propagation in tunnels with and without traffic. *IEEE Transactions on Antennas and Propagation*, Vol.45, No.3, (1996), pp.570-578.
- Didascalou, D.; Schafer, T. M., Weinmann, F. & Wiesbeck, W. Ray-density normalization for ray-optical wave propagation modeling in arbitrarily shaped tunnels. *IEEE Transactions on Antennas and Propagation*, Vol.48, No.9, (2000), pp.1316-1325.
- Didascalou, D., Maurer, J. & Wiesbeck, W. Subway tunnel guided electromagnetic wave propagation at mobile communications frequencies. *IEEE Transactions on Antennas and Propagation*, Vol.49, No.11, (2001), pp. 590-1596.
- Dudley, D. G. & Mahmoud, S. F. Linear Source in a Circular Tunnel. *IEEE Transactions on Antennas and Propagation*, Vol.54, No.7, (2006), pp.2034-2047.
- Dudley, D. G; Lienard, M., Mahmoud, S. F. & Degauque, P. Wireless propagation in tunnels. *IEEE Antennas and Propagation Magazine*, Vol.49, No.2, (2007), pp.11-26.
- Emslie, A.; Lagace, R. & Strong, P. Theory of the propagation of UHF radio waves in coal mine tunnels. *IEEE Transactions on Antennas and Propagation*, Vol.23, No.2, (1975), pp. 192-205.
- Halton, J. H. On the efficiency of certain quasi-Monte-Carlo sequences of points in evaluating multi-dimensional integrals. *Nummer. Math.*, Vol.2, (1960), pp.84-90.
- Hammersley, J. M. Monte Carlo methods, (1964).
- Hwang, Y.; Zhang, Y. P. & Kouyoumjian, R. G. Ray-optical prediction of radio-wave propagation characteristics in tunnel environments. 1. Theory. *IEEE Transactions on Antennas and Propagation*, Vol.46, No.9, (1998), pp.1328-1336.
- Iskander, M. F. & Yun, Z. Propagation prediction models for wireless communication systems. *IEEE Transaction on Microwave Theory and Techniques*, Vol.50, No.3, (2002), pp.662-673.
- Laakmann, K. D. & Steier, W. H. Waveguides: characteristic modes of hollow rectangular dielectric waveguides. *Appl. Opt.*, Vol.15, No.5, (1976), pp.1334-1340.
- Lienard, M. & Degauque, P. Propagation in wide tunnels at 2 GHz: a statistical analysis. *IEEE Transactions on Vehicular Technology*, Vol.47, No.4, (1998), pp.1322-1328.
- Lienard, M. Nasr A., Garcia Pardo J. M., Degaugue P. Experimental analysis of wave depolarization in arched tunnels. *The 18th Annual IEEE International Symposium on Personal, Indoor and Mobile Radio Communications (PIMRC'07)*, 2007.
- Mahmoud S. Characteristics of Electromagnetic Guided Waves for Communication in Coal Mine Tunnels. *IEEE Trans. Commun. Syst.*, Vol.22, No.10, (1974), pp.1547-1554.

- Mahmoud, S. F. Characteristics of Electromagnetic Guided Waves for Communication in Coal Mine Tunnels. *IEEE Trans. Commun. Syst.*, Vol.22, No.10, (1974), pp.1547-1554.
- Mariage, P.; Lienard, M. & Degauque, P. Theoretical and experimental approach of the propagation of high frequency waves in road tunnels. *IEEE Transactions on Antennas and Propagation*, Vol.42, No.1, (1994), pp.75-81.
- Marquardt, D. W. An algorithm for Least-Squares Estimation of Nonlinear Parameters. *J. Soc. Indust. Appl. Math.*, Vol.11, No.2, (1963), pp.431-441.
- Masson, E. Etude de la propagation des ondes électromagnétiques dans les tunnels courbes de section non droite pour des applications métro et ferroviaire. PhD thesis of the University of Poitiers, (2010).
- Masson, E.; Combeau, P., Cocheril, Y., Berbineau, M., Aveneau, L. & Vauzelle, R. Radio Wave Propagation in Arch-Shaped Tunnels: Measurements and Simulations using Asymptotic Methods. *Comptes Rendus - Physique*, Vol.11, (2010), pp.44-53.
- Morokoff, W. J. & Caflich, R. E. Quasi-monte carlo integration. *Journal of Computational Physics*, Vol.122, No.2, (1995), pp. 218-230.
- Popov, A. V. Modeling radio wave propagation in tunnels with a vectorial parabolic equation. *IEEE Transactions on Antennas and Propagation*, Vol.48, No.9, (2000), pp.1403-1412.
- Reutskiy, S. The methods of external excitation for analysis of arbitrarily-shaped hollow conducting waveguide. *Progress In Electromagnetics Research PIER 82*, (2008), pp.203-226.
- Seidl, S. Y & Rappaport, T. S. Site-specific propagation prediction for wireless in-building personal communication system design. *IEEE Transactions on Vehicular Technology*, Vol.43, No.3, (1994), pp.879-891.
- Torres, R. P.; Valle, L., Domingo, M., Loredó, S. & Diez, M. C. CINDOOR: An engineering tool for planning and design of wireless systems in enclosed spaces. *IEEE Antennas and Propagation Magazine*, Vol.41, No.4, (1999).
- Wang, T. S. & Yang, C. F. Simulations and Measurements of Wave Propagations in Curved Road Tunnels for Signals From GSM Base Stations. *IEEE Transactions on Antennas and Propagation*, Vol.54, No.9, (2006), pp.2577-2584.
- Zhang, Y. P. & Hwang, Y. Theory of the radio-wave propagation in railway tunnels. *IEEE Transactions on Vehicular Technology*, Vol.47, No.3, (1998), pp.1027-1036.
- Zhang, Y. P.; Hwang, Y. & Kouyoumjian, R. G. Ray-optical prediction of radio-wave propagation characteristics in tunnel environments. 2. Analysis and measurements. *IEEE Transactions on Antennas and Propagation*, Vol.46, No.9, (1998), pp.1337-1345.
- Zhang, Y. P. & Hwang, Y. Characterization of UHF radio propagation channels in tunnel environments for microcellular and personal communications. *IEEE Transactions on Vehicular Technology*, Vol.47, No.1, (1998), pp.283-296.
- Zhang, Y. P. Novel model for propagation loss prediction in tunnels. *IEEE Transactions on Vehicular Technology*, Vol.52, No.5, (2003), pp.1308-1314.
- Zhang, Y. P. & Hong, H. J. Ray-Optical Modeling of Simulcast Radio Propagation Channels in Tunnels. *IEEE Transactions on Vehicular Technology*, Vol.53, No.6, (2004), pp.1800-1808.