



HAL
open science

Results and Predictions of Imperfect Stress Relaxations Tests for the Reconstituted Onsøy Clay

Gilberto Alexandre, Ian Martins

► **To cite this version:**

Gilberto Alexandre, Ian Martins. Results and Predictions of Imperfect Stress Relaxations Tests for the Reconstituted Onsøy Clay. 2014. hal-00982641v3

HAL Id: hal-00982641

<https://hal.science/hal-00982641v3>

Preprint submitted on 1 May 2014

HAL is a multi-disciplinary open access archive for the deposit and dissemination of scientific research documents, whether they are published or not. The documents may come from teaching and research institutions in France or abroad, or from public or private research centers.

L'archive ouverte pluridisciplinaire **HAL**, est destinée au dépôt et à la diffusion de documents scientifiques de niveau recherche, publiés ou non, émanant des établissements d'enseignement et de recherche français ou étrangers, des laboratoires publics ou privés.

Results and Predictions of Imperfect Stress Relaxation Tests for the Reconstituted Onsøy Clay

Gilberto F. Alexandre, D.Sc.*; Ian S. M. Martins, D.Sc.†

May 1, 2014

Abstract

This paper presents results of 3 imperfect stress relaxation tests carried out on reconstituted Onsøy clay in the edometric apparatus as well as predictions made using the model proposed by Martins (1992) as modified by Alexandre (2006). The predictions presented herein were made in accordance to Alexandre and Martins (2013) where the soil viscosity function was assumed to follow a power law of the strain rate and also considering the soil to obey a logarithmic viscous function. Comparison between predictions and experimental results shows that satisfactory agreement were achieved for the 3 tests. However, the predictions using the logarithmic viscous function can be considered better than the ones made with the power law function.

1 Introduction

Alexandre and Martins (2013) have shown that the phenomena of the imperfect stress relaxation can be regarded as the combined result of creep in the soil and the effect of the actual rigidity of the testing equipment. Predictions made by the authors using the model proposed by Martins (1992) as modified by Alexandre (2006) for a very soft organic clay from Barra da Tijuca, Rio de Janeiro - Brazil, using a power law of the strain rate for representing the viscous function of the clay were in good agreement with experimental results both qualitatively and quantitatively. Despite of the good agreement, the experimental curves were somehow smoother than the predictions. One of the possible explanations for this difference was the chosen function, a power law of the strain rate. Although this function represented well the experimental results for the range of strain rate

*Post-doctoral fellow of the Schmertmann Research Laboratory at the Norwegian Geotechnical Institute (NGI), gilberto.alexandre@ngi.no

†Associate Professor at the Alberto Luiz Coimbra Institute for research in Engineering of the Federal University of Rio de Janeiro, Brazil (COPPE/UFRJ)

observed in the tests as attested by the high correlation coefficient ($R^2 = 0,974$), perhaps a different function could provide a better prediction.

This paper presents the analytical treatment of the imperfect stress relaxation phenomena under edometric conditions using a logarithmic function of the strain rate as an alternative to the power law function and compares it to the experimental results of tests carried out on reconstituted Onsøy clay as well as to predictions using the power law function as developed in Alexandre and Martins (2013).

2 Analytical development

The differential equation of the stress relaxation phenomena under edometric conditions (after the “end” of primary consolidation) using a power law function of the strain rate, as presented in Alexandre and Martins (2013) is:

$$\sigma_1(t) = \frac{P \cdot l_p - k \cdot (l_{pr}^2/l_s) \cdot x_s}{l_s \cdot A_s} = \sigma'_{1sA} + E_{ed} \cdot \frac{x_s}{H_s} + K \cdot \left(\frac{1}{H_s} \cdot \frac{dx_s}{dt} \right)^n \quad (1)$$

Where:

$\sigma_1(t)$ is the total normal stress as a function of the time t ;

P is the dead weight applied at the end of the loading arm of the edometric apparatus;

l_p , l_{pr} and l_s are dimensions as defined in the figure below;

k is the constant of the proving ring or load cell;

A_s is the area of the cross section and H_s is the height of the specimen of the soil;

E_{ed} is the edometric modulus for a given stress range at the vicinity of point A in the figure below;

σ'_{1sA} is the solid component of the normal effective stress at Point A of the figure below;

x_s is the vertical displacement of the top surface of the soil specimen in relation to the bottom surface; and

K and n are the constants of a power law viscous function of the strain rate ($\sigma'_v = K \cdot \dot{\varepsilon}^n$, where $\dot{\varepsilon}$ is the strain rate).

F_{pr} is the force in the proving ring/load cell.

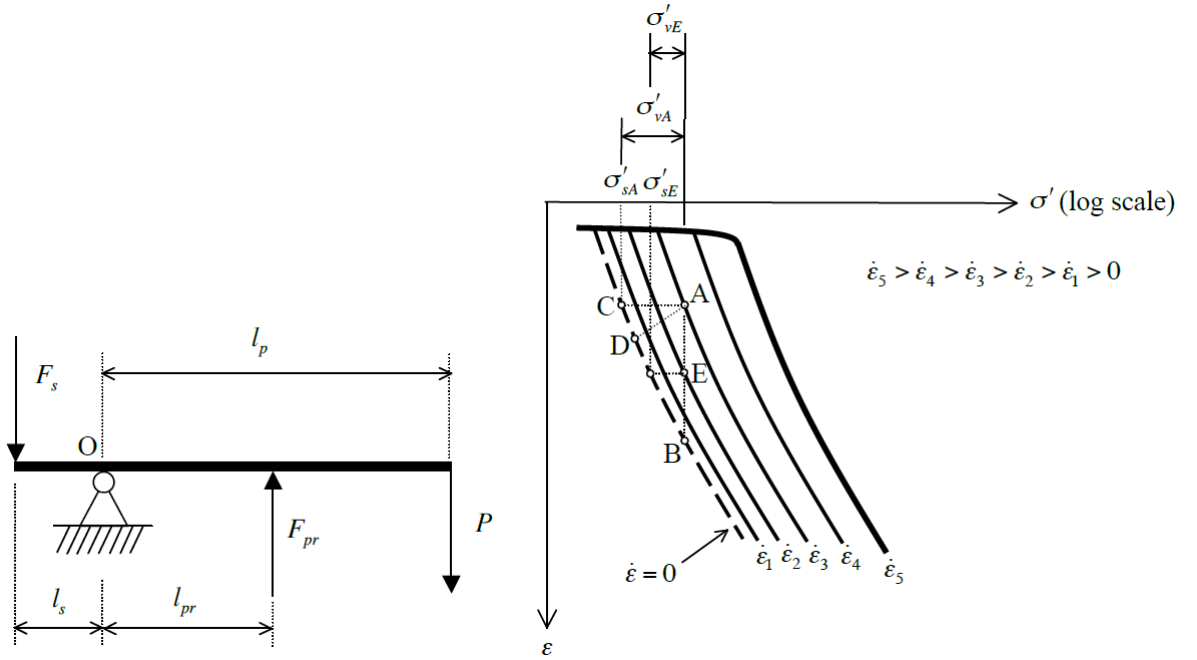
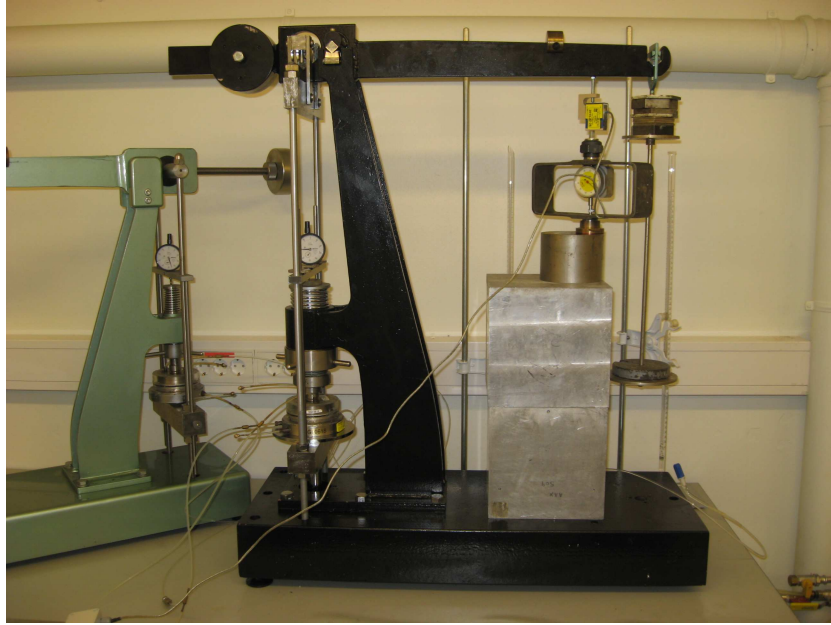

Figure 1: A picture of the set-up of the imperfect stress relaxation test under edometric conditions, the idealised structural representation and path followed (AD) by the specimen during the stress relaxation phase.

If the power law is replaced by a logarithmic function for representing the viscous function, the following differential equation is obtained:

$$\sigma_1(t) = \frac{P \cdot l_p - k \cdot (l_{pr}^2/l_s) \cdot x_s}{l_s \cdot A_s} = \sigma'_{1sA} + E_{ed} \cdot \frac{x_s}{H_s} + \left[B + A \cdot \ln \left(\frac{C}{H_s} \cdot \frac{dx_s}{dt} \right) \right] \quad (2)$$

Where A , B and C are constants of the viscous function.

Then, the solution of above differential equation is:

$$x_s = \left(\frac{A}{E^*} \right) \cdot \ln \left(1 + \frac{E^* \cdot \dot{x}_{s0}}{A} \cdot t \right) \quad (3)$$

Where:

$$E^* = \left(\frac{E_{ed}}{H_s} \right) + \frac{k}{A_s} \cdot \left(\frac{l_{pr}}{l_s} \right)^2;$$

$\dot{x}_{s0} = \left(\frac{H_s}{C} \right) \cdot e^{\left(\frac{\sigma - \sigma'_{1sA} - B}{A} \right)}$ is the initial vertical deformation rate at the beginning of the stress relaxation phase, and
 t it the time since the beginning of the stress relaxation phase.

Another equation of interest is the one for the vertical deformation rate, represented below:

$$\dot{x}_s = \frac{\dot{x}_{s0}}{1 + \left(\frac{E^* \cdot \dot{x}_{s0}}{A} \right) \cdot t} \quad (4)$$

Combination of Equations (2), (3) and (4) leads to the stress decrease during relaxation, which is the following:

$$\sigma_1(t) = \sigma'_{1sA} + \frac{E_{ed}}{H_s} \cdot \left(\frac{A}{E^*} \right) \cdot \ln \left(1 + \frac{E^* \cdot \dot{x}_{s0}}{A} \cdot t \right) + \left\{ B + A \cdot \ln \left[\frac{C}{H_s} \cdot \left(\frac{\dot{x}_{s0}}{1 + \left(\frac{E^* \cdot \dot{x}_{s0}}{A} \right) \cdot t} \right) \right] \right\} \quad (5)$$

The stress relaxation process comes to an end when the viscous component drops to zero. This condition is given by making the viscous function equal to zero, that is:

$$B + A \cdot \ln \left(\frac{C}{H_s} \cdot \frac{dx_s}{dt} \right) = 0 \quad (6)$$

Which means that the process will not stop at a vertical deformation rate of zero (Point D on Figure 1) but at a vertical deformation rate of:

$$\frac{dx_s}{dt} = \frac{H_s}{C} \cdot e^{\left(-\frac{B}{A} \right)} \quad (7)$$

The limitation of a minimum displacement rate is in fact a shortcoming of using a logarithmic function for the viscous component of the effective stresses.

A more reasonable and physically meaningful function would be one similar to the logarithmic function but that at the same time would present a zero viscous stress for a zero strain rate. However, the simplicity of the logarithmic function allows for an analytical treatment of the problem at the same time that the key physical aspects of the stress relaxation process are considered. Another possible approach would be to use a logarithmic function starting from a very small positive viscous stress and a positive strain rate and another (simple) function for the interval between the origin and the starting point of the logarithmic function.

An schematic representation of the stress relaxation process according to Equation (5) as well the solution of the differential equation using a power law for representing the viscous function (as presented in Alexandre and Martins, 2013) is presented below:

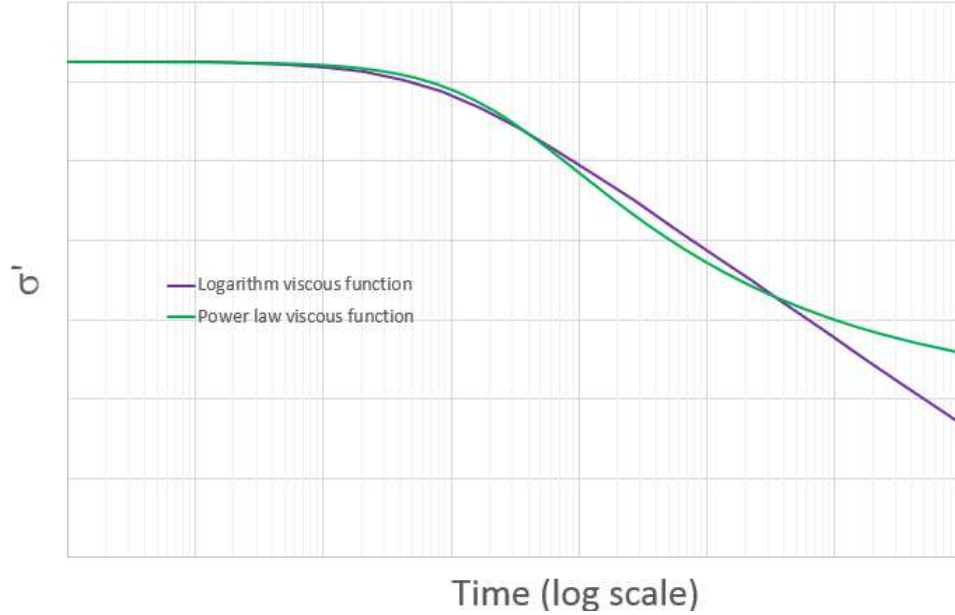

Figure 2: Comparison of the solutions of the stress relaxation tests for power law and logarithmic functions.

3 Parameter Assessment and Predictions

Considering that the displacements during the process change very little, that $\dot{x}_s = \frac{\dot{x}_{s0}}{1 + \left(\frac{E^* \cdot x_{s0}}{A}\right) \cdot t}$, $\dot{\epsilon} = \frac{\dot{x}_s}{H_s}$, and making $C = 1$, then Equation (5) can be written as:

$$\sigma_1(t) = \sigma'_{1sA} + B + A \cdot \ln(\dot{\epsilon}) \quad (8)$$

Then the parameters of the model can be assessed by making a plot of the stress in arithmetic scale x the strain rate in a logarithmic scale. In such a plot, these variables present themselves in a straight line in which the intercept of the vertical axis is the sum of B and σ'_{1sA} and the slope of this line is A . One example of such a plot, made for a stress relaxation test from vertical effective stress of 143 kPa is shown below:

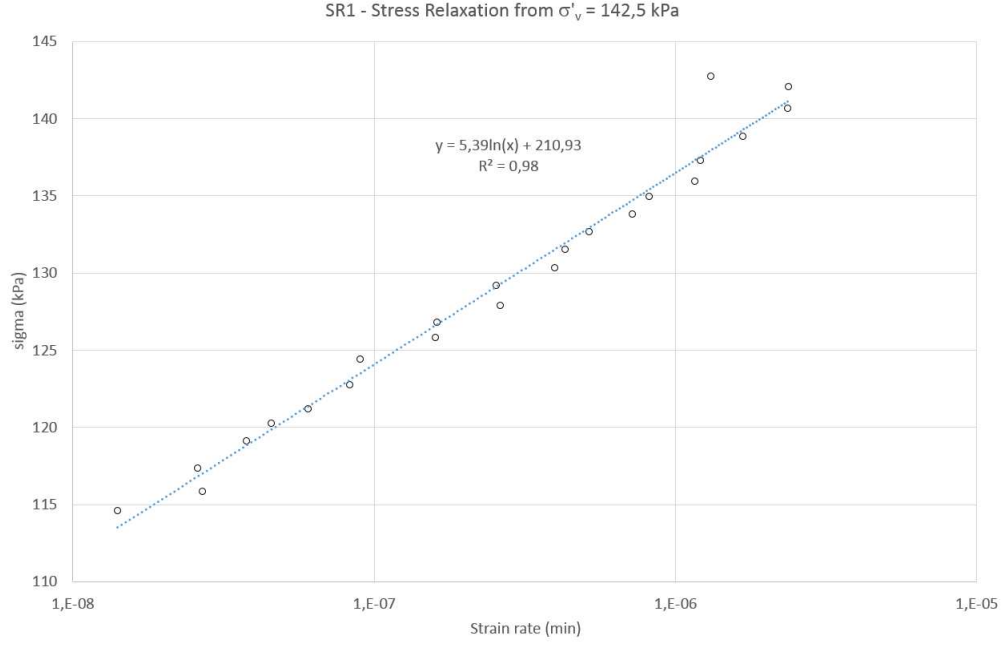

Figure 3: Plot for the assessment of pareameters.

With the knowledge of the value of the intercept and assuming a given value for σ'_{1sA} , then the value of B can be assessed. Even in the case that displacements are not measured, and therefore rate of displacement or strain rate are nor know, the parameters can be assessed by making a similar plot of stress x variation of stress over time ($\frac{d\sigma}{dt}$) instead of rate of displacement (or strain rate). This is possible because of the relationship between force and displacements, which is assumed to be linear, that is, $F = k \cdot x$. This relationship is:

$$\sigma_1(t) = \sigma'_{1sA} + B + A \cdot \ln\left(\frac{A_s}{k \cdot H_s}\right) + A \cdot \ln(\dot{\sigma}) \quad (9)$$

In this case, the intercept will be $\sigma'_{1sA} + B + A \cdot \ln\left(\frac{A_s}{k \cdot H_s}\right)$ and the slope remains the same, A .

Illustrative examples of these predictions together with test results on re-constituted Onsøy clay are presented below:

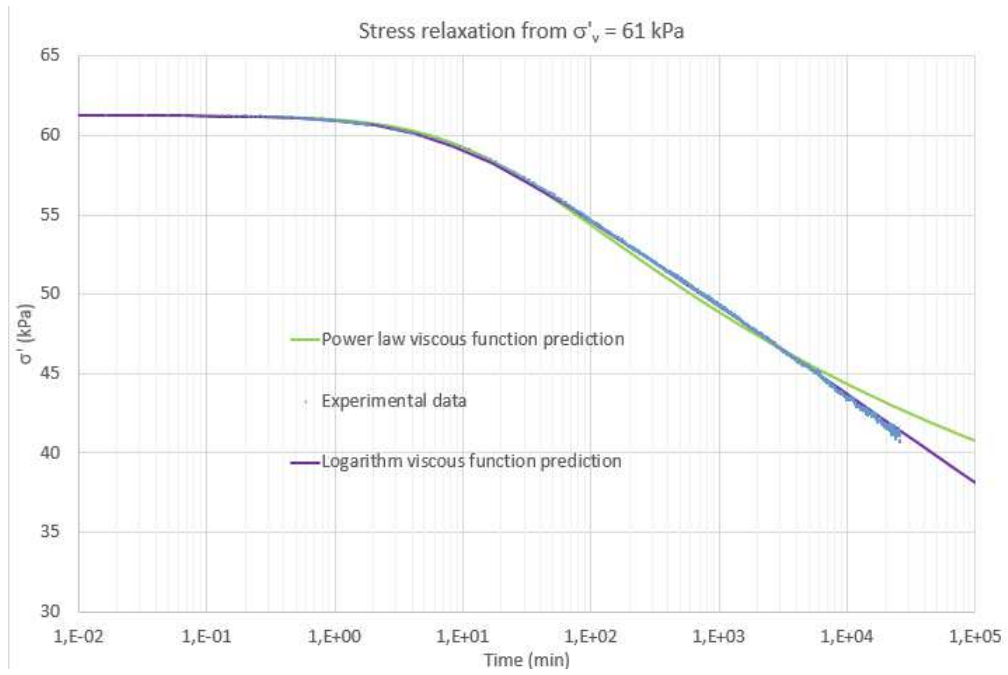

Figure 4: Predictions and experimental result on reconstituted Onsøy clay - Stress relaxation from 61 kPa.

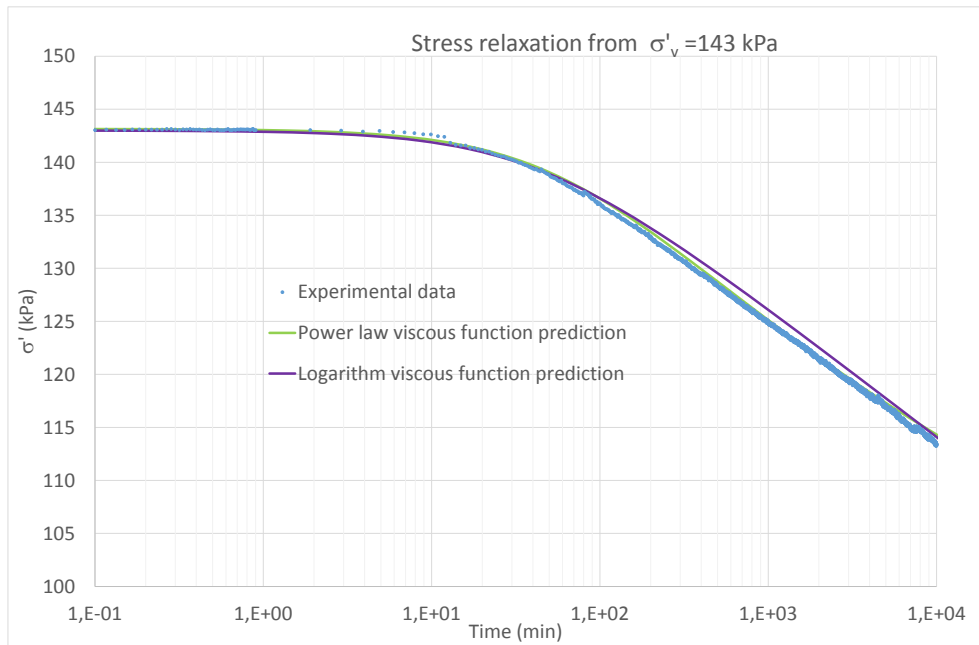

Figure 5: Predictions and experimental result on reconstituted Onsøy clay - Stress relaxation from 143 kPa.

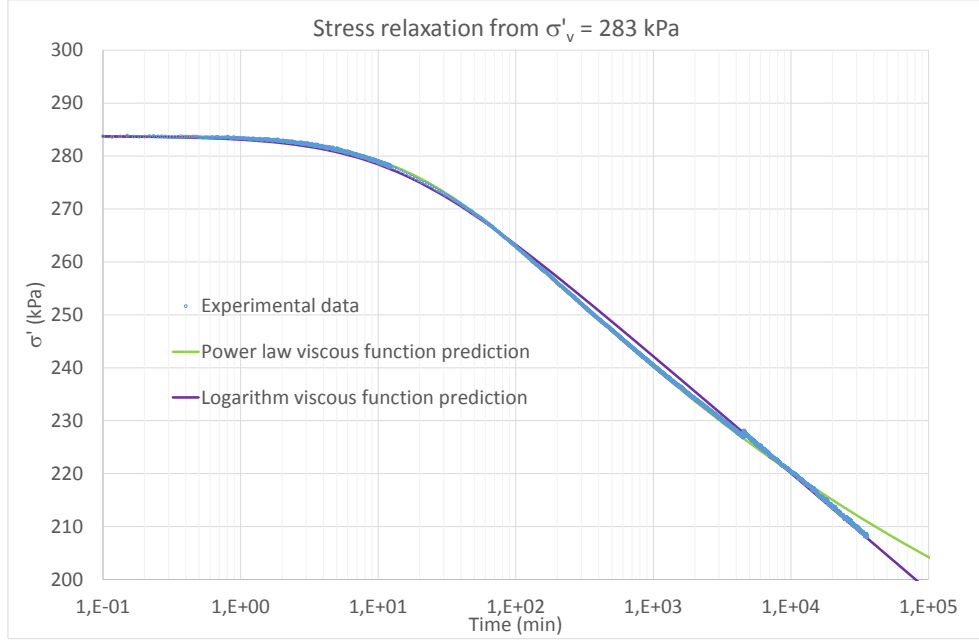

Figure 6: Predictions and experimental result on reconstituted Onsøy clay - Stress relaxation from 283 kPa.

A differential equation for the imperfect stress relaxation process during the shearing phase of a triaxial test using a logarithmic viscous function can be obtained in the same way as Alexandre and Martins (2013) by simply making $l_p = l_s = l_{pr} = 1$ in the equations above.

4 Conclusions

The differential equation and the solution of the imperfect stress relaxation process considering a logarithm function for representing the viscous component of the effective stresses were presented in this paper. Comparison between predictions and experimental result shows that for the reconstituted Onsøy clay the logarithm function predicts better the stress decay over time than the power law function.

5 Acknowledgments

The author would like to thank Dr. John Schmertmann, Professor Emeritus at University of Florida, the Research Council of Norway and the Norwegian Geotechnical Institute (NGI) for the support (financial and otherwise) provided during a post-doctoral research fellowship at the Schmertmann Research Laboratory. The author would also like to thank SSSS and LLLL for their suggestions, comments and criticism.

6 References

Alexandre (2006), Contribution to the Understanding of the Undrained Creep, D.Sc. thesis, COPPE/UFRJ, Rio de Janeiro, Brazil (in Portuguese)

Alexandre, G. F., and Martins, I. S. M., (2013), Stress Relaxation Under Various Stress and Drainage Conditions. HAL - Hyper Articles in Ligne (<http://hal.archives-ouvertes.fr>)

Martins, I. S. M., (1992), Fundamentals of a Behavioral Model for Saturated Clayey Soils, D.Sc. thesis, COPPE/UFRJ, Rio de Janeiro, Brazil (in Portuguese)