



HAL
open science

Abatement of 3-methylbutanal and trimethylamine with combined plasma and photocatalysis in a continuous planar reactor

Aymen Amine Assadi, Jordi Palau, Abdelkrim Bouzaza, Josep Penya-Roja, Vicente Martinez-Soriac, Dominique Wolbert

► To cite this version:

Aymen Amine Assadi, Jordi Palau, Abdelkrim Bouzaza, Josep Penya-Roja, Vicente Martinez-Soriac, et al.. Abatement of 3-methylbutanal and trimethylamine with combined plasma and photocatalysis in a continuous planar reactor. *Journal of Photochemistry and Photobiology A: Chemistry*, 2014, 282, pp.1-8. 10.1016/j.jphotochem.2014.03.001 . hal-00981617

HAL Id: hal-00981617

<https://hal.science/hal-00981617>

Submitted on 18 Jul 2014

HAL is a multi-disciplinary open access archive for the deposit and dissemination of scientific research documents, whether they are published or not. The documents may come from teaching and research institutions in France or abroad, or from public or private research centers.

L'archive ouverte pluridisciplinaire **HAL**, est destinée au dépôt et à la diffusion de documents scientifiques de niveau recherche, publiés ou non, émanant des établissements d'enseignement et de recherche français ou étrangers, des laboratoires publics ou privés.

Abatement of 3-methylbutanal and trimethylamine with combined plasma and photocatalysis in a continuous planar reactor

ASSADI Aymen Amine ^{a,b}, PALAU Jordi ^c, BOUZAZA Abdelkrim ^{a,b*}, PENYA-ROJA Josep M^c,
MARTINEZ-SORIA Vicente ^c, WOLBERT Dominique ^{a,b}

^a Laboratoire Sciences Chimiques de Rennes - équipe Chimie et Ingénierie des Procédés, UMR 6226
CNRS, ENSCR, 11 allée de Beaulieu, 35700 Rennes, France.

^b Université Européenne de Bretagne.

^c Department of Chemical Engineering, University of Valencia, Dr. Moliner 50, 46100 Burjassot,
Spain

* Corresponding author. Tel.: +33 2 23238056; fax: +33 2 23238120.

E-mail address: Abdelkrim.bouzaza@ensc-rennes.fr (A. BOUZAZA).

Abstract

This paper deals with the 3-methylbutanal ((CH₃)₂CHCH₂COH) removal with the help of a nonthermal surface plasma discharge coupled with photocatalysis. The capability of this process for gas treatment was studied. A planar reactor system was developed in order to perform the effect of adding photocatalytic material in plasma surface discharge barrier dielectric (SDBD) zone on (i) 3-methylbutanal removal, (ii) selectivity of CO₂ and CO, (iii) byproducts formation such as ozone formation.

It was found that the influence of the UV light generated by SDBD reactor was very low. The activation of the photocatalyst media could be negligible. Whereas, the introduction of external UV light to the process improves significantly the removal efficiency of 3-methylbutanal (3MBA) and the mineralization. A synergetic effect was observed by combining plasma SDBD and photocatalysis from all experiments and with other pollutant such as trimethylamine (N(CH₃)₃). Moreover, the byproducts of 3MBA were identified and evaluated with plasma SDBD, photocatalysis and plasma SDBD/photocatalysis combination.

Keywords:

Synergetic effect; planar reactor; Plasma SDBD/photocatalysis process; VOC removal

1. Introduction

37 The continual release of toxic gases into the atmosphere from variety of sources (due to
38 industrial discharges, transports, use of paints, domestic activities, etc.) has resulted in the
39 gradual degradation of the environment [1]. This consequence, in turn, has motivated
40 investigations into new methods of reducing and, if possible, preventing these harmful
41 emissions [2]. An increasing awareness of these emissions has resulted in legislation requiring
42 stringent enforcement of new regulations having the goal of improving the quality of the
43 environment [2]. As a result, many conventional techniques were proposed to remove VOCs
44 such as, ozone oxidation [4], incineration[5], combustion [6], adsorption [7], absorption and
45 photocatalysis [3, 8,14, 39, 40, 42-44].

46 Photocatalysis is an heterogeneous process between a solid phase (catalyst) containing a
47 semiconductor usually titanium dioxide (TiO_2) and the gas phase [9, 40, 42, 43]. The catalyst
48 is activated by photons provided by an ultra violet (UV) radiation (sunlight or UV lamps) [10-
49 12, 14, 44]. This technique has proven its ability to mineralize a large number of VOCs with
50 low energy consumption [9, 13]. Thus it appears to be a promising process for remediation of
51 air polluted by VOCs. Heterogeneous photocatalysis using TiO_2 has several advantages: (i)
52 the catalyst is cheap, (ii) it operates at ambient temperature, (iii) the byproducts are usually
53 CO_2 and H_2O , (iv) no other chemical reagent is needed.

54 Recently, the Nonthermal plasma (NTP) has been investigated, first time, by many
55 researchers for various applications such as removal of pollutants. The main advantage of
56 these non equilibrium plasmas consists in the ability to generate high-energy electrons, while
57 keeping the background gas close to room temperature[15]. Thus, a highly reactive
58 environment is created without spending energy on gas heating as in thermal processes [15,
59 16]. The energetic electrons excite, dissociate and ionize the gas molecules producing
60 chemically active species[17].

61 In recent years, plasma dielectric barrier discharge (DBD) has been investigated for the
62 abatement of volatile organic compounds including methanol [40], benzene [18],
63 dimethylamine [19], toluene [20, 21]and hydrogen sulfide [22].

64 The use of a catalyst in the plasma zone was reported to improve the efficiency in VOC
65 removal and CO_2 formation [30, 32, 37, 40]. The goal of this study was to try to combine the
66 advantages of photocatalysis and NTP by combining the two technologies in the same reactor
67 which should be able to treat larger flowrate than the laboratory reactors usually used.
68 Moreover, we can expect to observe a synergy effect by combining volumic plasma with
69 photocatalyst in a small reactor at flowrate equal to $200 \text{ mL}\cdot\text{min}^{-1}$ [24, 26].

70 A coupled system of surfacic plasma/photocatalysis in pilot reactor is established in the
71 present work to study the effect of adding UV external onthe pollutant degradation and
72 byproducts formation. 3-methylbutanal (3MBA) and trimethylamine (TMA)were chosen as
73 target pollutantssince these compounds were main molecules detected in the exhaust gases
74 from animal quartering centers.

75

76 **2. Experimental details**

77

78 **2.1. Reactor design and setup details**

79

80 The planar reactor consists of a rectangular cross section (135mm× 135mm) and is 1m length.
81 It is made of polymethyl methacrylate (PMMA) material. Two plates, 4mm thickness, are
82 arranged parallelto the length ofthe reactor and permit to hold up the catalyst media and the
83 two electrodes. The distance between the two plates, which is also the air gap, can be
84 modified. The planar photocatalytic reactor was equipped with eight UV lamps in order to
85 ensure a good radiation distribution (Fig. 1). The length of the irradiated zone is 0.8m. The
86 photocatalytic support surface is equal to 0.19 m². The used fluorescent UV lamp (Philips
87 under reference PL-S 9W/10/4P, 0.012m bulb diameter, 0.135m bulb length) had a major
88 wavelength peak emission at 355nm. The centerlines of the lamps were separated by a
89 distance of 0.01m.

90 The design of this reactor (Figure.2) was the subject of a Patent Application (BFF
91 11L1040/GB) [27].

92 The nonthermal plasma, of surface dielectric barrier type, is generated by a 2 mm thickness
93 grid with wire electrodes shaped as a rectangle. The distance between two wire electrodes was
94 20 mm. The outer electrode, connected to the ground, is a 1 mm thick and 80 cm length
95 copper foil. The electrodes were attached around the glass plate which its thickness (4 mm)
96 corresponded to the distance between them. The applied high voltage is about 30 kV/40 mA
97 and is a sine waveform. It was delivered by a TREK_30kV high voltage amplifier coupled
98 with a generator BFi OPTILAS.

99

100 **Figure 1: sectional drawing (a) and Schema (b) of plasma SDBD coupled with**
101 **photocatalysis in planar reactor.**

102

103 The applied voltage to the plasma SDBD was measured with a 1000:1 high voltage probe
104 (North Star SN_1704010). The NTP was obtained by submitting the electrodes to a sinusoidal
105 electric high voltage ranging from 0 to 30 kV at a 50 Hz frequency. A 2,5 nF capacitance (C_m)
106 was positioned between the outer electrode and the ground connection in order to collect the
107 charges transferred through the reactor. The applied voltage (U_a) and the high capacitance
108 voltage (U_m) were measured by LeCroy high voltage probes and recorded by a digital
109 oscilloscope (Lecroy Wave Surfer 24 Xs, 200 MHz). A schematic illustration of the plasma
110 SDBD setup is shown in Fig.2.

111

112 (a) (b)
113 **Fig 2: (a) General scheme for coupling plasma SDBD and photocatalysis, (b)**
114 **photographs of plasma SDBD in planar reactor.**

115

2.1. Polluted flow generation

116

117 A centrifugal compressor is used with ambient air. The flow rate is controlled by a flow meter
118 (Bronkhorst In-Flow). 3MBA(>99.7%, Sigma–Aldrich, Switzerland) and TMA(50wt. %
119 solution in water, Sigma–Aldrich, Switzerland) were used.Each pollutant
120 iscontinuouslyinjected by means of a syringe/syringe driver system (Kd Scientific Model 100)
121 through a septum into the gas stream and a heating system covering the injection zone sets the
122 gas temperature and facilitates the VOC vaporization ahead of the static mixer (Fig.3).

123 **Figure 3: Schematic view of the experimental setup**

124

2.2. Apparatus and Analysis

126

127 For the analysis, a FISIONS Gas chromatograph coupled with a flame ionization detector (GC-
128 FID) is used. 3MBA and byproducts separation are performed by a Chrompack FFAP-CB
129 column (25 m of length 0.32 mm of external diameter 0.32mm), which is specially adapted
130 for volatile fatty acids. Nitrogen gas constitutes the mobile phase. The identification of by-
131 products is done by Gas Chromatograph-Mass spectrometer (GC-MS) (Thermo Scientific)
132 equipped with an infrared (IR) detector. Under these conditions, the detectionlimit of 3MBA
133 and formed byproducts was 0.02ppmv.All injections are performed manually and repeated
134 three times with a syringe of 500 μ l. Analysis conditions are as follows (Table 1).

135

Table 1: Analysis conditions for the gas chromatograph

136 A standard iodometric titration method was used to estimate the formation of the downstream
137 ozone. Thus, at the outlet of the plasma reactor a constant flow rate of 200 L/h was bubbled on
138 iodine solution. The CO₂ has been analyzed by a Fourier Transform Infrared (FTIR)
139 spectrophotometer brand Environnement SA (Cosma Beryl reference 100). CO concentrations
140 were measured by CO ZRE gas analyzer. Temperature and relative humidity were measured
141 with a TESTO 445 probe.

142 2.3. Photocatalytic material

143

144 The used material is a coated Glass Fiber Tissue (GFT) with 6.5 g/m² of colloidal silica to
145 ensure the fixation of 6.5 g/m² of P25-Degussa titanium dioxide nanoparticles. It is supplied
146 by Ahlstrom Research and Services. P25-Degussa nanoparticles were made of two titanium
147 dioxide allotropic forms, 80% is anatase, 20% is rutile. The coating process consists of an
148 impregnation of glass fibers by SiO₂ and TiO₂ nanoparticles suspension in pure water using
149 Ahlstrom industrial size-press. Specific surface area was measured according to BET method
150 and was equal to 20.6 m² g⁻¹. Preparation process is precisely described in the study of
151 Enriquez and co-workers [14] and Ahlstrom Patent [28].

152

153 3. Results and Discussion

154 The average temperature was equal to 20 °C. It should be noted that, whether the UV lamp
155 could potentially heat up the air, the measured outlet temperature of the gas never exceeds the
156 above-mentioned value. This is due to the nature of the open continuous reactor where the air-
157 flow evacuates the heat.

158

159 3.1. Removal of 3-methylbutanal

160 The VOC Removal Efficiency (RE) is defined as:

$$161 \quad RE(\%) = \frac{C_{in} - C_{out}}{C_{in}} \times 100\% \quad (1)$$

162 Where C_{in} and C_{out} are the inlet and outlet concentration of 3MBA (mg.m⁻³) respectively.

163 Moreover we use the Lissajous plot method (Manley, 1943) for calculating mathematically
164 the power input (P) (eq.2).

$$165 \quad P \text{ (W)} = E \text{ (J)} \times F \text{ (Hz)} \quad (2)$$

166 Where P is the input power (W), E is the injected energy (J) and F is the frequency (Hz). The
167 value of input power is varied by changing the applied voltage (Ua). In fact, the injected
168 energy (E) per cycle dissipated in the DBD reactor is equal to the area of Lissajous curve
169 (Fig.2).A Lissajous curve was obtained by plotting the charges transferred by the plasma
170 versus the voltage applied to the reactor, as shown in figure 2.

171 The quantity of charges Q (μC) transferred by the discharge was measured by multiplying the
172 capacitance C_m (nF) by the applied voltage U_a (kV) in the plasma SDBD reactor [45].

173 In the case of fig.2, the discharge power was estimated to be 6 W.

174 After the specific energy (SE) is then calculated as:

$$175 \quad SE \text{ (J/L)} = P \text{ (W)} / [1000 * Q \text{ (m}^3\text{/h)} / 3600] \quad (3)$$

176 Where SE was the specific energy (J/L), Q was the flowrate ($\text{m}^3\text{/h}$).

177 **Figure 4: Lissajous curve obtained at 50 Hz.**

178

179 **3. Results and discussion**

180

181 The main target of this work was to study the removal of 3MBA by plasma coupled with TiO_2
182 without external UV in order to investigate the effect of UV light from the SDBD reactor in
183 TiO_2 activation.

184 The effects of several parameters, such as specific energy (SE), residence time in the reactor
185 and inlet concentration on the contaminant removals were investigated.

186 The domain of gas flowrate, inlet concentration tested, UV intensity, and the applied voltage
187 of plasma SDBD were summarized in Table 2.

188 **Table 2: Parameters of plasma DBD+ TiO_2 /UV reactor**

189

190 **3.1. Influence of UV generated by plasma on TiO_2**

191

192 **3.1.1. On removal of 3-methylbutanal**

193

194 During the present study, concentration of 3MBA was kept constant (50 mg.m^{-3}) in order to
 195 understand the influence of SE on the performance of the reactor. Moreover, the applied
 196 voltage was varied between 12 and 29 kV that corresponds to SE of 5 and 16 J.L^{-1} ,
 197 respectively. As seen from Fig. 5, with the two processes (plasma only and plasma with TiO_2
 198 without external UV), removal of 3MBA increases with increasing the SE. In fact, the radicals
 199 and the excited species which were produced by the energetic electrons in the discharge phase
 200 could efficiently oxidize 3MBA and accordingly improved the RE of 3MBA. This result is in
 201 agreement with works on plasma SDBD removal of methanol [40], acetylene [23] and toluene
 202 [20, 21].

203 On the other hand, Fig.5 shows that the RE of 3MBA was not enhanced in presence of
 204 photocatalyst without external UV. So, the UV light from the plasma SDBD was very weak to
 205 activate the TiO_2 . Its contribution to the removal of 3MBA in plasma SDBD/photocatalysis
 206 combination reactor could be ignored. Similar results have been reported in the literature for
 207 some VOCs [23, 24].

208

209 **Figure 5: Dependence of RE on SE in situ in different plasma systems without external**
 210 **UV ($[\text{3MBA}] = 50 \text{ mg m}^{-3}$, $Q = 10 \text{ m}^3 \text{ h}^{-1}$, $T = 20 \text{ }^\circ\text{C}$, $\text{RH} = 50\%$).**

211

212 3.1.2. On selectivities of CO and CO_2

213

214 The CO_2 overall selectivity (CO overall selectivity can be also defined) may be a useful
 215 parameter to assess the performance of the plasma SDBD towards 3MBA removal. It allows
 216 estimating the mineralization rate i.e. the ultimate reaction step, of each process of oxidation.

217 The CO_x selectivity is expressed as follow (eq. 4):

$$218 \quad \left\{ \text{CO}_x \text{'s overall selectivity (\%)} \right\} = \frac{[\text{CO}_x]^{out} - [\text{CO}_x]^{in}}{5 \times [\text{3MBA}]^{in} \times \{ \% \text{ RE} \}} \times 10^4 \quad (4)$$

219 where $x = 1$ for CO and $x = 2$ for CO_2 . $[\text{CO}_x]^{in}$ and $[\text{CO}_x]^{out}$ were the inlet and outlet
 220 concentration of carbon mono/dioxide respectively (ppmv). $[\text{3MBA}]^{in}$ was the inlet
 221 concentration of 3MBA (ppmv). The number 5 was the stoichiometric coefficient of the
 222 removal reaction.

223

224 **Figure 6.a: Variation of CO and CO₂ selectivities vs. the SE using two processes**
 225 **without external UV: empty symbol = selectivity of CO₂ and full symbol = selectivity of**
 226 **CO ([3MBA] = 50 mgm⁻³, Q = 10m³h⁻¹, T= 20 °C, RH = 50%).**

227

228 Fig. 6.a shows the selectivity of CO_x (CO and CO₂). As seen, the selectivity of CO_x was bad
 229 and never close to 100%. In fact, the selectivity to CO₂ was around 19 % at 16 J.L⁻¹.
 230 Moreover, we note that the increase of SE leads to an increase of overall selectivities. This is
 231 due to more electrons and reactive species (such as [•]O and [•]OH) which were formed when the
 232 SE increased and then much molecules of 3MBA were oxidized into CO₂ and CO [26, 40, 46].
 233 In fact an increase in SE from 5, 2 to 16 J.L⁻¹ leads to CO and CO₂ overall selectivity
 234 increased from 3 to 12 % and from 9 to 19 %, respectively. These results are in agreement
 235 with works on removal of methanol [40], acetaldehyde [30] and acetylene [26, 31].

236 We can also note that the presence of photocatalyst on the plasma zone, does lead to more
 237 mineralization.

238 The others byproducts in the exit of reactor were identified and evaluated. To evaluate the
 239 validity of the analysis method i.e. to be sure that the majority of byproducts were detected,
 240 mass carbon balance was estimated (fig.6.b).

241 In fact, mass carbon balance CB (%) was calculated from the sum of acetone (CH₃COCH₃),
 242 acetic acid (CH₃COOH), CO₂ and CO as follows:

$$243 \quad CB(\%) = \frac{[CH_3COOH] + [CH_3COCH_3] + [CO_2] + [CO]}{5 \times [3MBA]^m \times \left\{ \% IRE \right\}_{Isov}} \times 100\% \quad (5)$$

244 where [CH₃COOH], [CH₃COCH₃], [CO] and [CO₂] were respectively the concentration of
 245 acetic acid, acetone, carbon monoxide and carbon dioxide (ppmv). Figure 6.b shows that with
 246 these processes the mass carbon balance was achieved. This means that the majority of
 247 organic byproducts are detected. Moreover, we obtained the same byproducts using two
 248 processes without external UV.

249

250 **Fig.6.b. Variation of mass balances and byproducts of 3MBA with residence time using**
 251 **plasma alone and plasma with TiO₂ ([3MBA] = 50 mg m⁻³, Q = 10m³ h⁻¹, T= 20 °C, RH =**
 252 **50%).**

253 3.1.3. On the ozone formation

254

255 Ozone is an inevitable byproduct in a NTP. Atomic oxygen was generated by O_2 dissociation
256 due to impact with high energy electrons (reaction 1).



258 Atomic oxygen is a strong oxidizer, but its stability is very limited. Due to fast
259 recombination processes, the lifetime is only a few microseconds at atmospheric pressure [4,
260 16, 38, 39]

261 Atomic oxygen reacts successively with O_2 in three-body collisions, forming ozone by the
262 following reaction:



264 where M can be either molecular oxygen or molecular nitrogen [4].

265 As seen from Fig 7, when the SE increases, the quantity of ozone increases as well. That
266 could be explained by the fact that more electrons and reactive species (such as $\cdot O$) were
267 formed and then leads to ozone production (reactions 1 & 2) [16, 38, 39].

268

269 **Figure 7: Dependence of the ozone formation on SE on in situ under different plasma**
270 **systems without external UV ($[3MBA] = 50 \text{ mg m}^{-3}$, $Q = 10 \text{ m}^3 \text{ h}^{-1}$, $T = 20 \text{ }^\circ\text{C}$, $RH = 50\%$)**

271

272 Moreover, it is interesting to note that the presence of photocatalyst without external UV
273 surface enhances the quantity of ozone in the outlet flow. Thus, this experiment illustrates that
274 the active species generated ($\cdot O$) by plasma are able to react with other species like fibers of
275 TiO_2 than to recombine with oxygen molecules for forming ozone (reaction 2). This result is
276 similar to the work of Allegraud [32].

277

278 3.2. Combination of plasma-photocatalysis with external UV

279

280 The UV light generated by plasma SDBD is very weak to activate the TiO_2 . Its contribution to
281 the 3MBA removal by plasma SDBD/photocatalysis combination reactor could be
282 ignored. Thus, we introduced eight external UV light into the planar reactor to activate the
283 photocatalyst media. Moreover, 3MBA removal experiments were carried out under three

284 configurations: photocatalysis (TiO_2+UV), plasma and plasma SDBD/photocatalysis coupling
285 ($\text{Plasma SDBD}/\text{TiO}_2+\text{UV}$). The removal efficiency, mineralization and by-products formation
286 are determined.

287 It is important to note that without photocatalyst media, 3MBA removal is not affected by UV
288 radiations.

289

290 **3.2.1. On the removal efficiency**

291

292 On Figure 8, the variation of 3MBA removal efficiency, by coupling process, as a function of
293 the sum of removal efficiency due to plasma and photocatalysis is represented.

294 We can see that 3MBA removal by coupling plasma and photocatalysis was about 5 to 15%
295 higher than the sum of the conversions recorded, under the same conditions, for plasma and
296 photocatalysis alone.

297 For example, when $[\text{3MBA}] = 50 \text{ mgm}^{-3}$ and $Q = 4 \text{ m}^3.\text{h}^{-1}$, by photocatalysis alone, the
298 removal efficiency of 3MBA was around 25 %. When NTP alone ($\text{SE} = 13.7 \text{ J.L}^{-1}$) was used,
299 the 3MBA removal reaches to 48 %. By coupling plasma SDBD and photocatalysis, the
300 3MBA removal increased to 83% (10% higher than the contribution of each process).

301 This synergetic effect was observed under various experimental conditions (Fig.8)

302 This synergy may be assigned to:

- 303 • The contribution of reactive species, formed by plasma SDBD, in photocatalytic
304 mechanisms [23, 37, 40].
- 305 • The desorption of by-products attached at TiO_2 surface by plasma. This leads to
306 renewal of catalytic surface and so improves conversion and mineralization processes [24,
307 36]

308

309 **Figure.8: 3MBA removal efficiency by coupling process vs the sum of removal efficiency**
310 **of plasma and photocatalysis at different residence time, inlet concentration and specific**
311 **energy in planar reactor ($T = 20 \text{ }^\circ\text{C}$, $\text{RH} = 50\%$, $I = 20 \text{ W.m}^{-2}$).**

312

313 So as to better understand the presence of synergetic effect with plasma and photocatalysis,
314 others experiments with TMA were carried out.

315 Figure 9 shows the variation of the TMAremoval with flowrate using the three configurations
316 at $SE=13 \text{ J.L}^{-1}$.

317

318 **Figure 9: TMAremoval with flow rate for the different tested configurations ($SE=13 \text{ J.L}^{-1}$
319 1 , $[TMA] = 145 \text{ mg/m}^3$, $RH=50\%$, $T= 20 \text{ }^\circ\text{C}$).**

320

321 On the other hand, figure 9 illustrates the results for TMAremoval for the photocatalysis alone
322 (UV), plasma SDBD alone (without TiO_2) and for the coupling of plasma SDBD and
323 photocatalysis. By photocatalysis alone (irradiation of TiO_2 by external UV light), 24% of the
324 TMA was removed. When plasma SDBD was used alone and at $Q= 4 \text{ m}^3.\text{h}^{-1}$, the TMA
325 removal reaches to 36% without photocatalyst.

326 By coupling plasma SDBD and photocatalysis, the TMAremoval increased to 74%. Thus, the
327 TMA removal by coupling plasma SDBD and photocatalysis was 14% higher than the sum of
328 the removals recorded at the same conditions for plasma SDBD alone and photocatalysis
329 alone. With this pollutant, we note that the synergistic effect was higher than that with 3MBA.
330 Thus, whatever the pollutant was used, experimental results when plasma SDBD and
331 photocatalysis were combined show a better efficiency in removal than the simple addition of
332 the two processes, revealing then a synergy effect which it appears for all the values of tested
333 flowrate.

334

335 **3.2.2. On the selectivity of CO_2**

336

337 The CO selectivity can be considered as negligible for plasma and plasma SDBD
338 /photocatalysis coupling processes.

339 We note that, with photocatalysis alone the final concentration of CO was lower than the
340 detection limits of CO ZRE analyzer ($<0.05 \text{ ppmv}$). This result is in agreement with works on
341 photocatalytic degradation of fatty acids [33], cyclohexane [34] and trichloroethylene (TCE)
342 [9]. On other hand, CO detection could be obviously affected by the residence time under
343 otherwise identical conditions. In fact, with decomposition of gas-phase dimethyl
344 methylphosphonate [46], photocatalysis alone can produce a very low amount of CO.

345 CO_2 selectivity for the photocatalysis alone (UV), plasma SDBD alone and for the coupling
346 processes is presented in figure 10. One can note that when combining the two processes

347 carbon dioxide selectivity was improved compared to plasma SDBD alone whatever is the
348 value of SE.

349 By photocatalysis alone, the selectivity of CO₂ was around 59%. When plasma SDBD alone
350 was used the CO₂ selectivity is 19 % at SE = 16 J.L⁻¹. But by coupling these technologies, the
351 CO₂ selectivity is about 40%, an intermediate value between photocatalysis alone and plasma
352 SDBD alone.

353 Thus, total mineralization by TiO₂ photocatalysis is well-known.

354

355 **Fig 10: Variation of the overall selectivity of CO₂ vs. SE using the three**
356 **processes([3MBA] =50 mg.m⁻³, Q = 10m³.h⁻¹, T= 20 °C, RH=50%, I= 20 W.m⁻²).**

357 We note that with photocatalysis alone and plasma SDBD/photocatalysis coupling processes,
358 the detected byproducts are propionic acid, acetone and acetic acid. We note that with plasma
359 alone, the detected byproducts are acetone and acetic acid.

360

361 3.2.3. On ozone formation

362

363 The residual ozone concentration at the reactor exit for each process (plasma alone and the
364 combined process) is represented in figure 11. The result proves that the amount of ozone
365 formed by plasma SDBD alone is higher to that due to the combined plasma SDBD/TiO₂+UV.
366 These results suggest that UV can play a role either in inhibiting the ozone formation or in
367 ozone decomposition [38, 40].

368 Thus, this experiment illustrates that the active species generated ([•]O) by plasma are able to
369 more oxidize 3MBA and also to react with oxygen molecules for forming ozone [37-40].

370 Using the study result of Taranto and co-workers [40] the activation of TiO₂ by UV radiation
371 can reduce the formation of ozone or favor its destruction by the following reaction [9, 38,
372 40]:



375 Atomic oxygen thus-formed can play a role in the removal of 3MTBA. This result is in
376 agreement with work of methanol removal [40].

377 We note that photocatalyst reactor alone does not produce ozone.

378

379 **Figure 11: Variation of amount of ozone with the SE using two processes ([3MBA]= 50**
380 **mgm⁻³, Q = 10m³.h⁻¹, T= 20 °C, RH = 50%, I= 20 W.m⁻²).**

381

382 In order to more investigate this ozone behavior, the planar reactor was operated in two parts:
383 the first part was with plasma SDBD alone and the second part with photocatalytic process
384 (TiO₂ + UV). The quantification of the ozone was done at the outlet of each part.

385 The result shows that the amount of ozone was reduced when TiO₂ catalyst is irradiated by
386 UV (fig. 12).

387 At SE equal to 16 J.L⁻¹, the ozone concentration in the first part is 61 ppmv and decreases to
388 48 ppmv at the exit of the reactor (the second part). The same behavior is seen with SE equal
389 to 9 J.L⁻¹. These results show that UV irradiation is able to promote ozone elimination. Ozone
390 can also contribute to 3MBA removal on the photocatalytic surface [40].

391 This behavior is another reason to explain the synergetic effect between plasma SDBD and
392 photocatalysis.

393

394 **Figure 12: Variation of amount of ozone with the SE using two parts of planar**
395 **reactor([3MBA]= 50 mg.m⁻³, Q = 10m³.h⁻¹, T= 20 °C, RH = 50%, I= 20 W.m⁻²).**

396

397 **4. Conclusions**

398

399 The goal of this paper was to compare the behavior of 3MBA removal when catalysis (TiO₂
400 without external UV) and plasma SDBD are combined, to each process taken separately in
401 order to determine whether or not a synergy effect was present. Our result showed that the
402 UV light from the SDBD reactor was very weak to activate the TiO₂. Its contribution to the
403 removal of 3MBA in plasma SDBD/photocatalysis combination reactor could be ignored.

404 For each operating parameter, we had unambiguously shown that a synergetic effect for the
405 3MBA and TMA removal can be observed when NTP is coupled with TiO₂ catalyst irradiated
406 by external UV.

407 The behavior of combining plasma SDBD and photocatalyst in the same planar reactor had
408 shown that the ozone can be easily decomposed.

409

410 **Acknowledgment**

411

412 The authors gratefully acknowledge the financial support provided by the French National
413 Research Agency (ANR) for this research work.They thank also the Ahlstrom Company
414 which provided them with the photocatalytic material.

415

416

417

418

419

420

421

422

423

424

425

426

427

428

429

430

431

432 **References:**

- 433 [1] ADEME, Pollutions olfactives : origine, législation, analyse, traitement. Ademe, Dunod, Angers,
434 2005.
435
- 436 [2] CITEPA, Emissions dans l'air en France métropole-substance relative à l'acidification,
437 l'eutrophisation et à la pollution photochimique 2011.
- 438
- 439 [3] H. Huang, D. Y.C. Leung, L.G. Li, K.H. Michael, X. Fu, Photocatalytic destruction of air
440 pollutants with vacuum ultraviolet (VUV) irradiation, *Catalysis Today* 175 (2011) 310–315.
- 441 [4] R. Atkinson, D. L. Baulch, R. A. Cox, J. N. Crowley, R. F. Hampson, R. G. Hynes, M. E. Jenkin,
442 M. J. Rossi, J. Troe, Evaluated kinetic and photochemical data for atmospheric chemistry: Part 1 - gas
443 phase reactions of Ox, HOx, NOx and Sox species. *Atmospheric chemistry and Physics Discussions* 3
444 (2003) 6179–6699.
- 445 [5] Le Cloirec P. « COV (composés organiques volatils) » 2004, tech.ing. G1835.
- 446 [6] M.Wang, A. Lawal, P. Stephenson, J. Sidders, C. Ramshawa, Post-combustion CO₂ capture with
447 chemical absorption: A state-of-the-art review, *chemical engineering research and design* 89 (2011)
448 1609–1624.
- 449 [7] J. Matos, A. Garcia, J-M. Chovelon, C. Ferronato, Combination of Adsorption on Activated
450 Carbon and Oxidative Photocatalysis on TiO₂ for Gaseous Toluene Remediation, the *Open Materials*
451 *Science Journal*. 4 (2010) 23-25
- 452 [8] J. Palau, J. M. Peña-Roja, C. Gabaldon, F. J. Alvarez-Hornos, V. Martinez-Soria, Effect of pre-
453 treatments based on UV photocatalysis and photo-oxidation on toluene biofiltration performance, *J*
454 *Chem Technol Biotechnol*.87 (2011) 65-72.
- 455 [9] P. Pichat, J. Disdier, C. Hoang-Van, D. Mas, G. Goutailler, C. Gaysse, Purification/deodorization
456 of indoor air and gaseous effluents by TiO₂ photocatalysis, *Catalysis Today* 63 (2000) 363–369
- 457 [10] A. Bouzaza, C. Vallet, A. Laplanche, Photocatalytic degradation of some VOCs in the gas phase
458 using an annular flow reactor: determination of the contribution of mass transfer and chemical reaction
459 steps in the photodégradation process. *Journal of Photochemistry and Photobiology A: Chemistry*. 177
460 (2006) 212–217.
- 461
- 462 [11] J.L. Shie, C. H. Lee, C. S. Chiou, C.T. Chang, C. C. Chang, C.Y. Chang, Photodegradation
463 kinetics of formaldehyde using light sources of UVA, UVC and UVLED in the presence of composed
464 silver titanium oxide photocatalyst, *Journal of Hazardous Materials* 155 (2008) 164–172.
- 465
- 466 [12] A. A. Assadi, J. Palau, Bouzaza A., D. Wolbert, a continuous air reactor for photocatalytic
467 degradation of 3-methylbutanal : Effect of different operating parameters and Chemical degradation
468 pathway. *Chemical engineering research and design* 91 (2013) 1307–1316
- 469
- 470 [13] A.A. Assadi, A. Bouzaza, D. Wolbert, Photocatalytic oxidation of Trimethylamine and
471 Isovaleraldehyde in an annular reactor: Influence of the Mass Transfer and the relative humidity.
472 *Journal of Photochemistry and Photobiology A: Chemistry* 236 (2012) 61–69.

- 473 [14] R. Enriquez, B. Beaugiraud, P. Pichat, Mechanistic implications of the effect of TiO₂
474 accessibility in TiO₂-SiO₂ coatings upon chlorinated organics photocatalytic removal in water.
475 *Water Sci Technol.*, 49 (2004) 147-152.
- 476
- 477 [15] A. M. Vandembroucke, R. Morent, N. De Geyter, Ch. Leys, Non-thermal plasmas for non-
478 catalytic and catalytic VOC abatement, *Journal of Hazardous Materials* 195 (2011) 30–54.
- 479 [16] J. Jolibois, K. Takashima, A. Mizuno, Application of a non-thermal surface plasma discharge in
480 wet condition for gas exhaust treatment: NO_x removal, *Journal of Electrostatics* 70 (2012) 300-308.
- 481 [17] Y.S. Mok, D.H. Kim, Treatment of toluene by using adsorption and nonthermal plasma oxidation
482 process *Current applied physics*, 11(2011) S58–S62.
- 483 [18] H.H. Kim, S.M. Oh, A. Ogata, S. Futamura, Decomposition of gas-phase benzene using plasma-
484 driven catalyst (PDC) reactor packed with Ag/TiO₂ catalyst, *Appl. Catal. B: Environ.* 56 (2005) 213–
485 220.
- 486 [19] Zh. Ye, J. Zhao, H. Y. Huang, F. Ma, R. Zhang, Decomposition of dimethylamine gas with
487 dielectric barrier discharge, *Journal of Hazardous Materials* 260 (2013) 32-39
- 488 [20] J.H. Byeon, J. H. Park, Y.S. Jo, K.Y. Yoon, J. Hwang, Removal of gaseous toluene and
489 submicron aerosol particles using a dielectric barrier discharge reactor. *J. Hazard. Mater.* 175 (2010)
490 417–422.
- 491 [21] W. Mista, R. Kacprzyk, Decomposition of toluene using non-thermal plasma reactor at room
492 temperature, *Catal. Today* 137 (2008) 345–349.
- 493
- 494 [22] E.L. Reddy, J. Karuppiah, A. Renken, L.K. Minsker, C. Subrahmanyam, Kinetics of the
495 decomposition of hydrogen sulfide in a dielectric barrier discharge reactor, *Chem. Eng. Technol.* 35
496 (2012) 2030–2034.
- 497 [23] O. Guaitella, F. Thevenet, E. Puzenat, C. Guillard, A. Rousseau, C₂H₂ oxidation by plasma/TiO₂
498 combination: Influence of the porosity, and photocatalytic mechanisms under plasma exposure,
499 *Applied Catalysis B: Environmental*. 80 (2008) 296–305.
- 500
- 501 [24] A. Maciucă, C. Batiot-Dupeyrat, J-M. Tatibouët, Synergetic effect by coupling photocatalysis
502 with plasma for low VOCs concentration removal from air *Applied Catalysis B: Environmental*, 125
503 (2012) 432–438
- 504 [25] T. Ochiai, Y. Hayashi, M. Ito, K. Nakata, T. Murakami, Y. Morito, A. Fujishima, An effective
505 method for a separation of smoking area by using novel photocatalysis-plasma synergistic air-cleaner,
506 *Chemical Engineering Journal* 209 (2012) 313–317.
- 507
- 508 [26] F. Thevenet, O. Guaitella, E. Puzenat, C. Guillard, A. Rousseau, Influence of water vapour on
509 plasma/photocatalytic oxidation efficiency of acetylene. *Applied Catalysis B: Environmental* 84
510 (2008) 813–820.
- 511

512 [27] P. Petit, P.-J. Vialle, A. Maciuca, C. Batiot-Dupeyrat, J.-M. Tatibouet, A. Assadi, A. Bouzaza, D.
513 Wolbert, Dispositif de traitement de gaz et sa méthode d'assemblage, système et procédé de traitement
514 de gaz. CIAT, ENSCR, CNRS. France (2013) Patent N°1354353.

515 [28] Ahlstrom Patent EP 1069950, 2000. AU 735798 US 09/467, 650; JP 2000-542104.
516

517 [29] T.C. Manley, Proceedings of the 84th General Meeting, New York, 1943.

518 [30] H.M. Lee, M.B. Chang, Gas-phase removal of acetaldehyde via packed-bed dielectric barrier
519 discharge reactor, Plasma Chem. Plasma Process. 21(2001) 329-343.

520 [31] M Redolfi., N. Aggadi, X. Duten, S. Touchard, S. Pasquiers, K. Hassouni, 2009. Oxidation of
521 Acetylene in Atmospheric Pressure Pulsed Corona Discharge Cell Working in the Nanosecond
522 Regime, Plasma Chem Plasma Process 29 (2009) 173–195.

523 [32] K. Allegraud. Décharge à Barrière Diélectrique de Surface : physique et procédé, thèse Ecole
524 polytechnique de Paris, 2008.

525 [33] P.F. Biard, A. Bouzaza, D. Wolbert, Photocatalytic degradation of two volatile fatty acids in an
526 annular plug-flow reactor: kinetic modeling and contribution of mass transfer rate. Environ. Sci.
527 Technol. 41 (2007) 2908–2914.

528 [34] Q. Geng, Q. Guo, X. Yue, 2010. Adsorption and Photocatalytic Degradation Kinetics of Gaseous
529 cyclohexane in an Annular Fluidized Bed Photocatalytic Reactor, Ind. Eng. Chem. Res. 49 (2010)
530 4644–4465.
531

532 [35] F.Ouni, A. Khacef, J. M.Cormier, Syngas Production from Propane Using Atmospheric Non-
533 thermal Plasma Plasma Chem Plasma Process 29 (2009) 119–130.
534

535 [36] L. Sivachandiran, F. Thevenet, A. Rousseau, Non-Thermal Plasma Assisted Regeneration of
536 Acetone Adsorbed TiO₂ Surface, Plasma Chem Plasma Process 33 (2013) 855–871.

537 [37] A.S. Besov, A.V. Vorontsov, Acceleration of Acetone Destruction Process under Synergistic
538 Action of Photocatalytic Oxidation and Barrier Discharge, Plasma Chemistry and Plasma
539 Processing 27 (2007) 624–634.

540 [38] S. O.Hay, T. N.Obee, the Augmentation of UV Photocatalytic Oxidation with Trace Quantities of
541 Ozone, 4 (1999) 209-221

542 [39] S. O. Hay, T.N. Obee, C.Thibaud-Erkey, the deactivation of photocatalytic based air purifiers by
543 ambient siloxanes, Applied Catalysis B: Environmental 99 (2010) 435–441

544 [40] J. Taranto, D. Frochot, P. Pichat, Combining Cold Plasma and TiO₂ Photocatalysis To Purify
545 Gaseous Effluents: A Preliminary Study Using Methanol-Contaminated Air, Ind. Eng. Chem. Res. 46
546 (2007) 7611-7614.

- 547 [41] P. Pichat, Some views about indoor air photocatalytic treatment using TiO₂: Conceptualization of
548 humidity effects, active oxygen species, problem of C₁–C₃ carbonyl pollutants, Applied Catalysis B:
549 Environmental 99 (2010) 428–434.
- 550 [42] A. Fujishima, X. Zhang, D. A. Tryk, TiO₂ photocatalysis and related surface phenomena, Surface
551 Science Reports 63 (2008) 515-582.
- 552 [43] M. A. Henderson, A surface science perspective on TiO₂ photocatalysis, Surface Science Reports
553 66 (2011) 185–297.
- 554 [44] P. Pichat, representative examples of infrared spectroscopy uses in semiconductor photocatalysis,
555 Catalysis Today (2013) in press.
- 556 [45]K. Allegraud, O. Guaitella, A. Rousseau, Spatio-temporal breakdown in surface DBDs: evidence
557 of collective effect, J. Phys. D: Appl. Phys. 40 (2007) 7698–7706.
- 558 [46] T. N. Obee, S. Satyapal, Photocatalytic decomposition of DMMP on titania, Journal of
559 Photochemistry and Photobiology A: Chemistry 118 (1998) 45-51.

560

561

562

563

564

565

566

567

568

569

570

571

572

573 **Table:**

574 Table 1: Parameters of plasma SDBD+TiO₂/UV reactor

575

Parameter	Value & domain
Gas temperature	Ambient (293 K)
Gas pressure	Atmospheric pressure (1 atm)
Relative humidity	50±5 %
Applied voltage	12 to 29 kV
Gas flowrate	4 to 10 Nm ³ h ⁻¹
Inlet concentration	50 to 100 mg m ⁻³
UV intensity	20 W m ⁻²

576

577 **Table 2: Analysis conditions for the gas chromatograph**

Gas pressure			Zone temperature	
N ₂ (gas carrier, kPa)	H ₂ (kPa)	Air (kPa)	Injector (°C)	Oven (°C)
105	40	100	110	50

578

579

580

581

582

583

584

585

586

587

588 **Figures:**

589 Figure 1: Schema (b) and sectional drawing (a) of plasma SDBD coupled with photocatalysis
590 in planar reactor.

591
592 Figure 2: (a) General scheme for coupling plasma SDBD and photocatalysis, (b) photographs
593 of plasma SDBD in planar reactor.

594
595 Figure 3: Schematic view of the experimental setup

596
597 Figure 4: Lissajous curve obtained at 50 Hz.

598
599 Figure 5: Dependence of RE on SE on in situ in different plasma systems without external UV
600 ($[3MBA] = 50 \text{ mg m}^{-3}$, $Q = 10 \text{ m}^3 \text{ h}^{-1}$, $T = 20 \text{ }^\circ\text{C}$, $\text{RH} = 50\%$).

601
602 Figure 6.a: Variation of CO and CO₂ selectivities vs. the SE using two processes without
603 external UV: empty symbol = selectivity of CO₂ and full symbol = selectivity of CO
604 ($[3MBA] = 50 \text{ mg m}^{-3}$, $Q = 10 \text{ m}^3 \text{ h}^{-1}$, $T = 20 \text{ }^\circ\text{C}$, $\text{RH} = 50\%$).

605 Figure 6.b. Variation of mass balances and byproducts of 3MBA with residence time using
606 two processes without external UV ($[3MBA] = 50 \text{ mg m}^{-3}$, $Q = 10 \text{ m}^3 \text{ h}^{-1}$, $T = 20 \text{ }^\circ\text{C}$, $\text{RH} =$
607 50%).

608 Figure 7: Dependence of the ozone formation on SE in situ under different plasma systems
609 without external UV ($[3MBA] = 50 \text{ mg m}^{-3}$, $Q = 10 \text{ m}^3 \text{ h}^{-1}$, $T = 20 \text{ }^\circ\text{C}$, $\text{RH} = 50\%$)

610 Figure.8: 3MBAremoval efficiency by coupling process vs the sum of removal efficiency of
611 plasma and photocatalysis at different residence time, inlet concentration and specific energy
612 in planar reactor ($T = 20 \text{ }^\circ\text{C}$, $\text{RH} = 50 \%$, $I = 20 \text{ W.m}^{-2}$).

613 Figure 9: Trimethylamine conversion with flow rate for the different tested configurations
614 ($\text{SE} = 13 \text{ J.L}^{-1}$, $[\text{TMA}] = 145 \text{ mg/m}^3$, $\text{RH} = 50\%$, $T = 20 \text{ }^\circ\text{C}$).

615 Figure 10: Variation of the overall selectivity of CO₂ vs. SE using the three processes
616 ($[3MBA] = 50 \text{ mg.m}^{-3}$, $Q = 10 \text{ m}^3 \text{ .h}^{-1}$, $T = 20 \text{ }^\circ\text{C}$, $\text{RH} = 50 \%$, $I = 20 \text{ W.m}^{-2}$).

617 Figure 11: Variation of amount of ozone with the SE using two processes ($[3MBA] = 50 \text{ mg}$
618 m^{-3} , $Q = 10 \text{ m}^3 \text{ .h}^{-1}$, $T = 20 \text{ }^\circ\text{C}$, $\text{RH} = 50 \%$, $I = 20 \text{ W.m}^{-2}$).

619 Figure 12: Variation of amount of ozone with the SE at exits of plasma alone and combined
620 process in planar reactor ($[3MBA] = 50 \text{ mg .m}^{-3}$, $Q = 10 \text{ m}^3 \text{ .h}^{-1}$, $T = 20 \text{ }^\circ\text{C}$, $\text{RH} = 50 \%$, $I = 20$
621 W.m^{-2}).

622

623

624

625

626

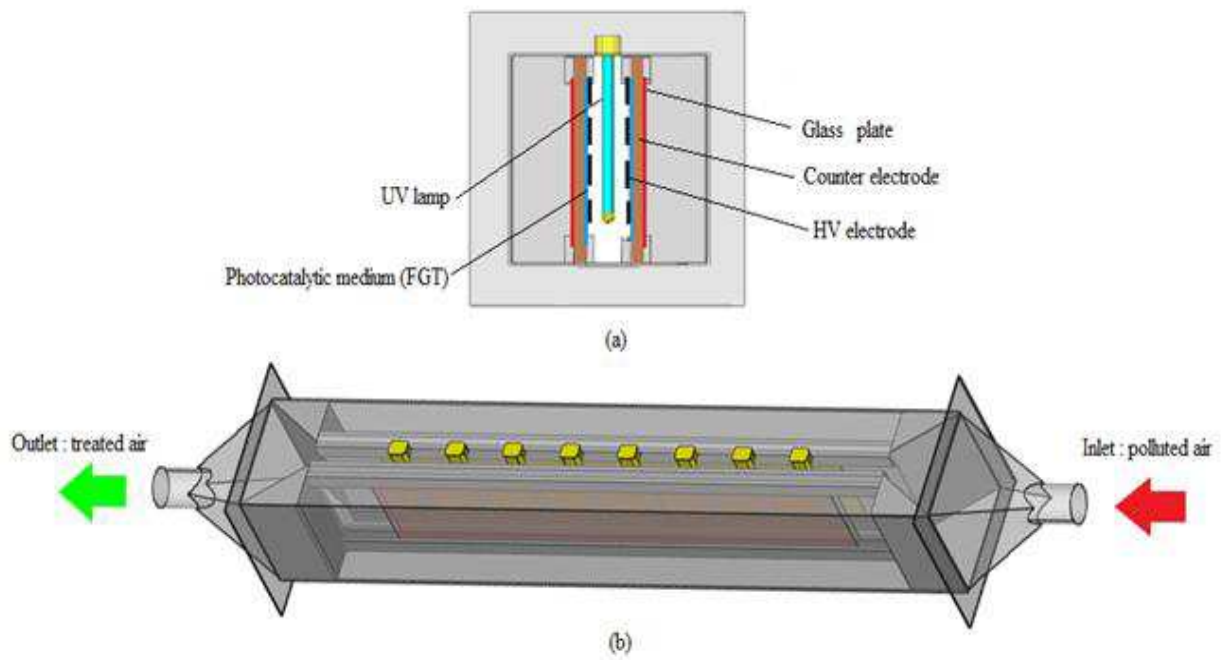

627

628 Figure 1: Schema (b) and sectional drawing (a) of plasma SDBD coupled with photocatalysis
629 in planar reactor.

630

631

632

633

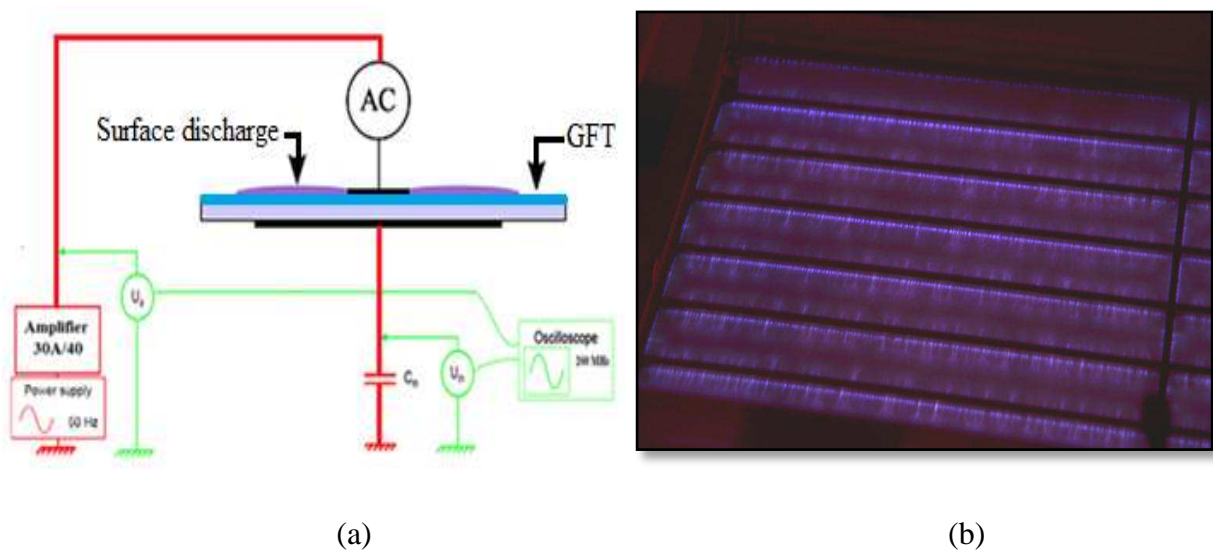

634

635

636 Figure 2: (a) General scheme for coupling non-thermal plasma and photocatalysis, (b)
637 photographs of plasma SDBD in planar reactor.

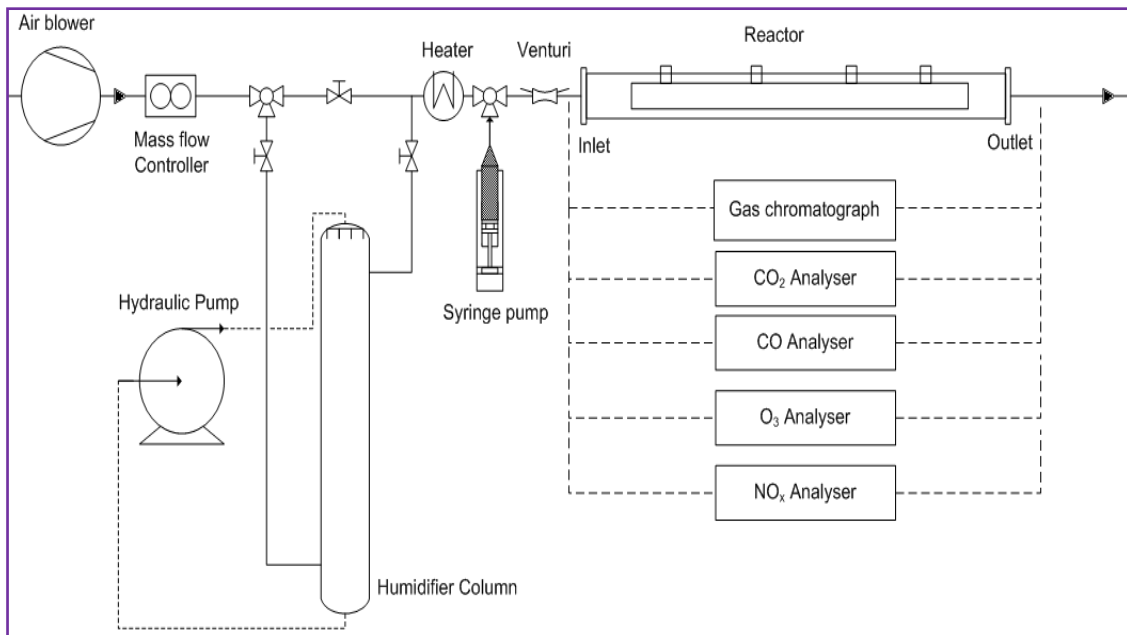

638

639

Figure 3: Schematic view of the experimental setup

640

641

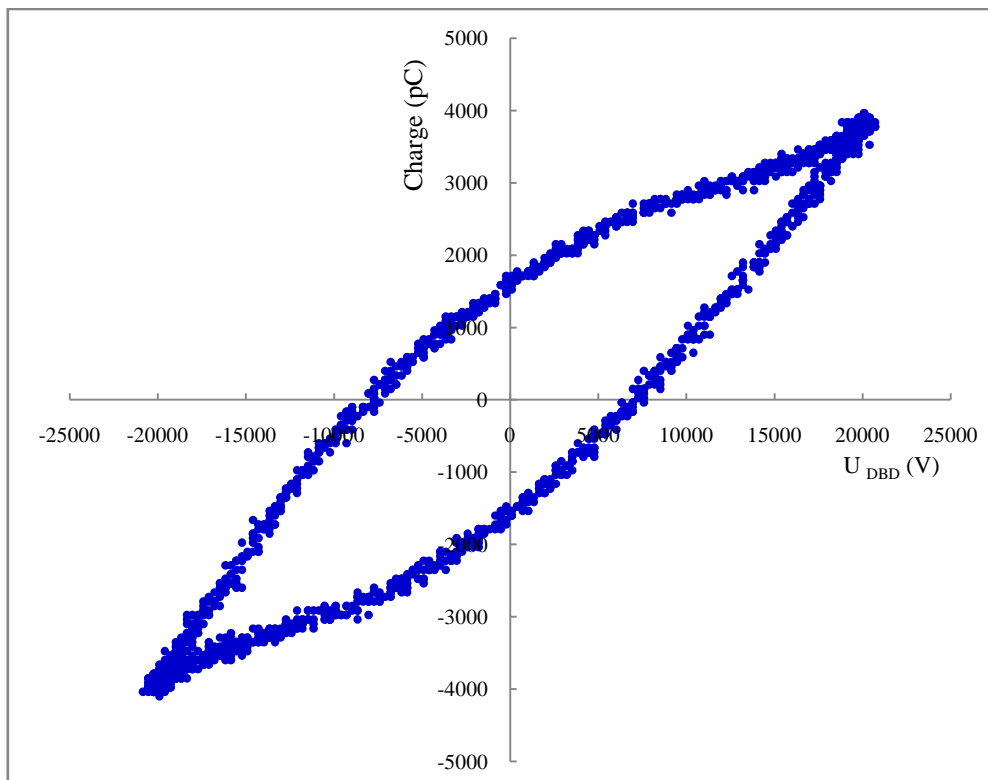

642

643

Figure 4: Lissajous curve obtained at 50 Hz.

644

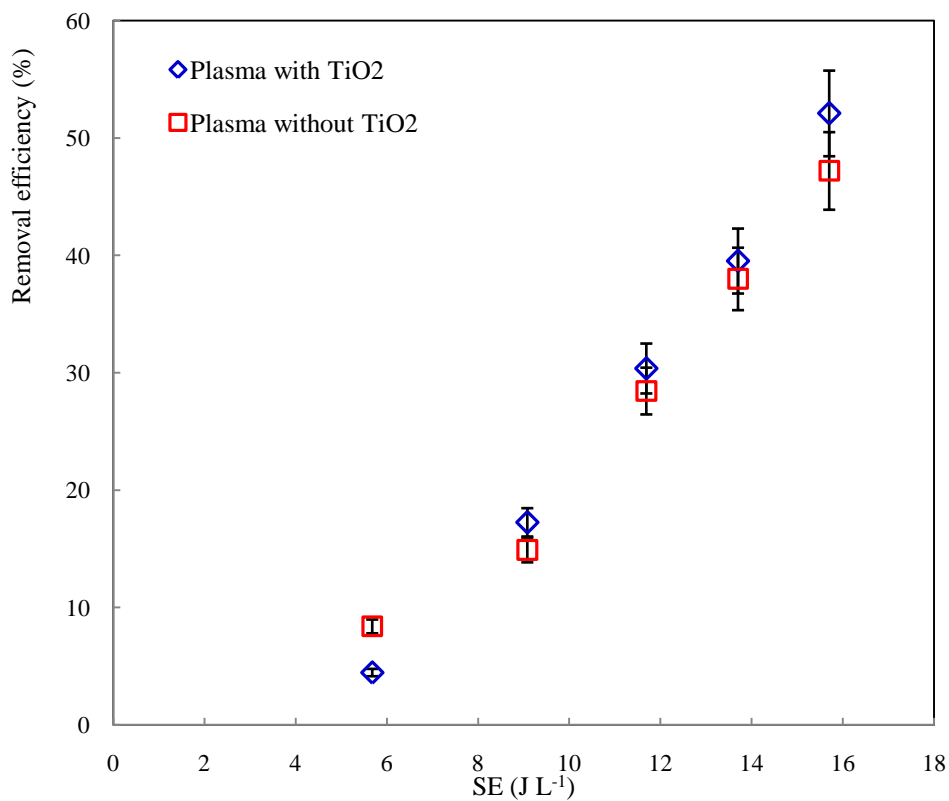

645

646 Figure 5: Dependence of RE on SE in situ in different plasma systems without external UV

647

([3MBA] = 50 mg m⁻³, Q = 10m³h⁻¹, T= 20 °C, RH = 50%).

648

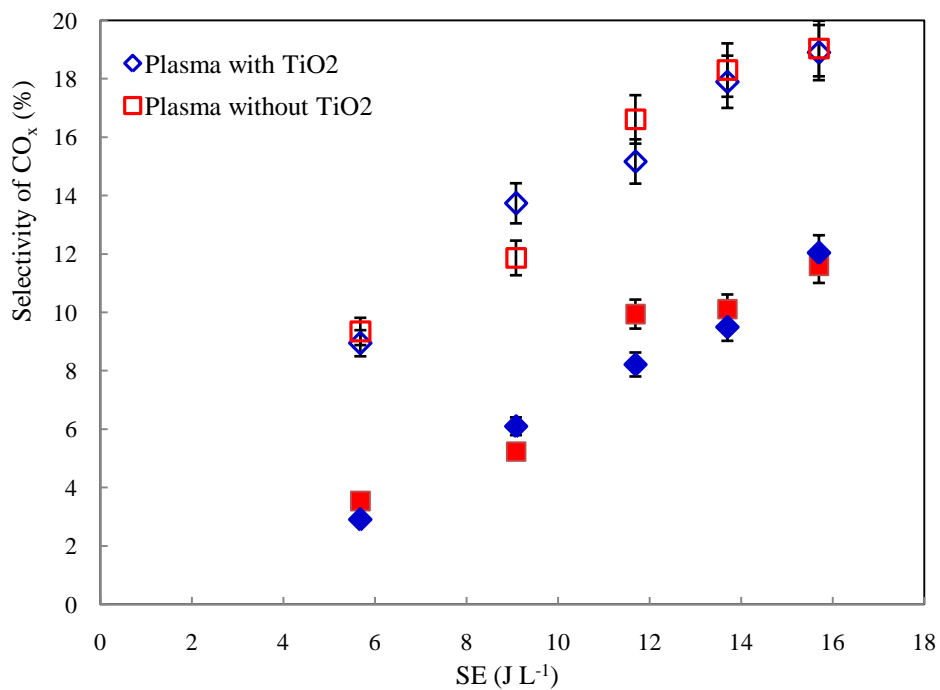

649

650 Figure 6.a: Variation of CO and CO₂ selectivities vs. the specific energy using two

651 processes without external UV: empty symbol = selectivity of CO₂ and full symbol =

652 selectivity of CO ([3MBA] = 50 mg m⁻³, Q = 10m³ h⁻¹, T= 20 °C, RH = 50%).

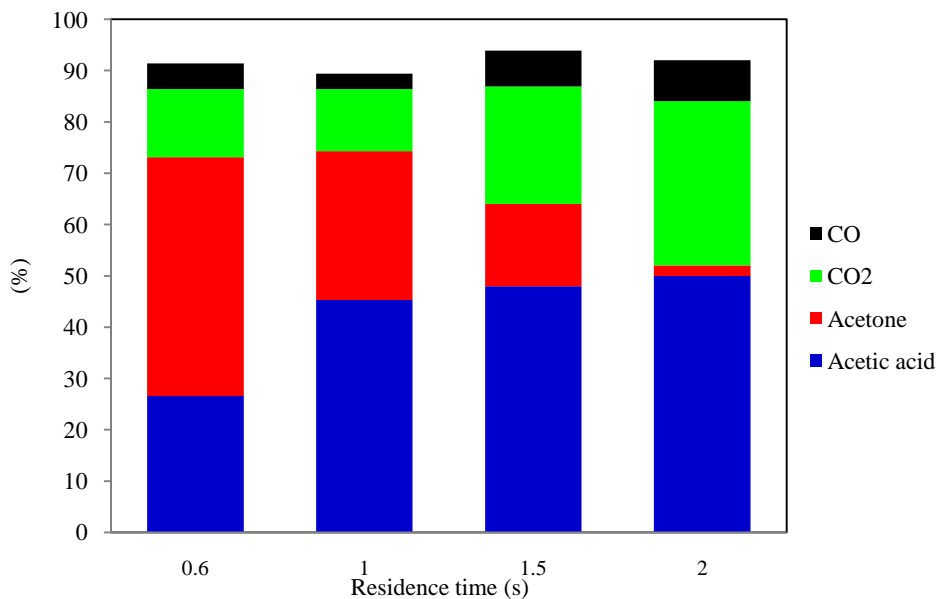

653
 654 Figure.6.b. Variation of mass balances and by-products of 3 MBA with residence time using
 655 two processes without external UV ($[3\text{MBA}] = 50 \text{ mg m}^{-3}$, $Q = 10\text{m}^3 \text{ h}^{-1}$, $T = 20 \text{ }^\circ\text{C}$, $\text{RH} =$
 656 50%).

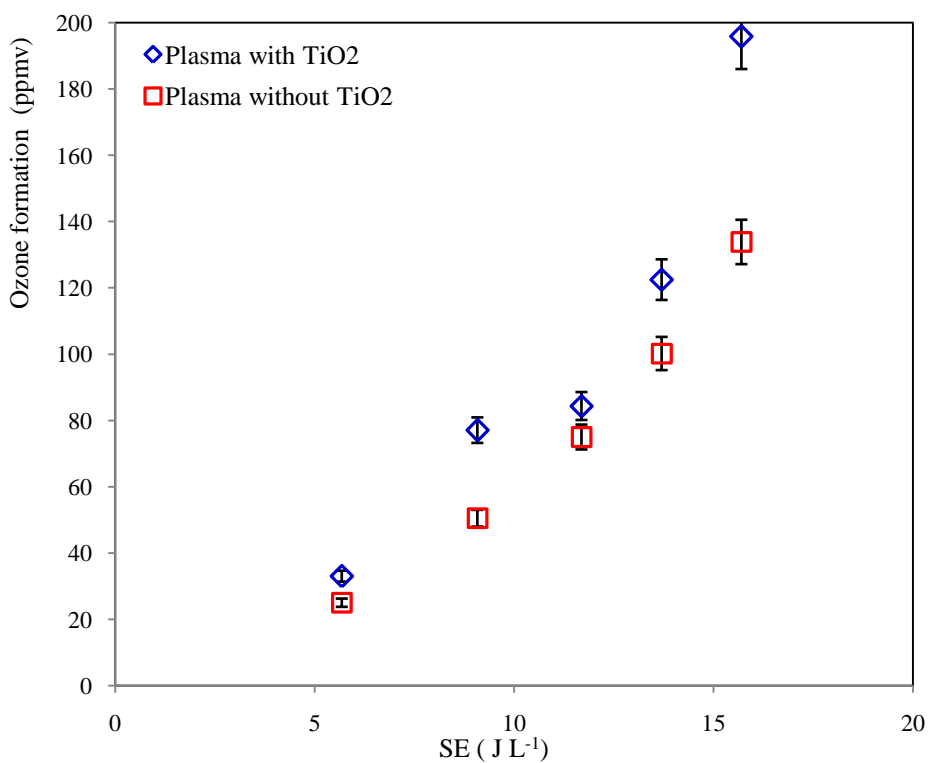

657
 658 Figure 7: Dependence of ozone formation on the SE in situ under different plasma systems
 659 without external UV ($[3\text{MBA}] = 50 \text{ mg m}^{-3}$, $Q = 10\text{m}^3 \text{ h}^{-1}$, $T = 20 \text{ }^\circ\text{C}$, $\text{RH} = 50\%$)

660

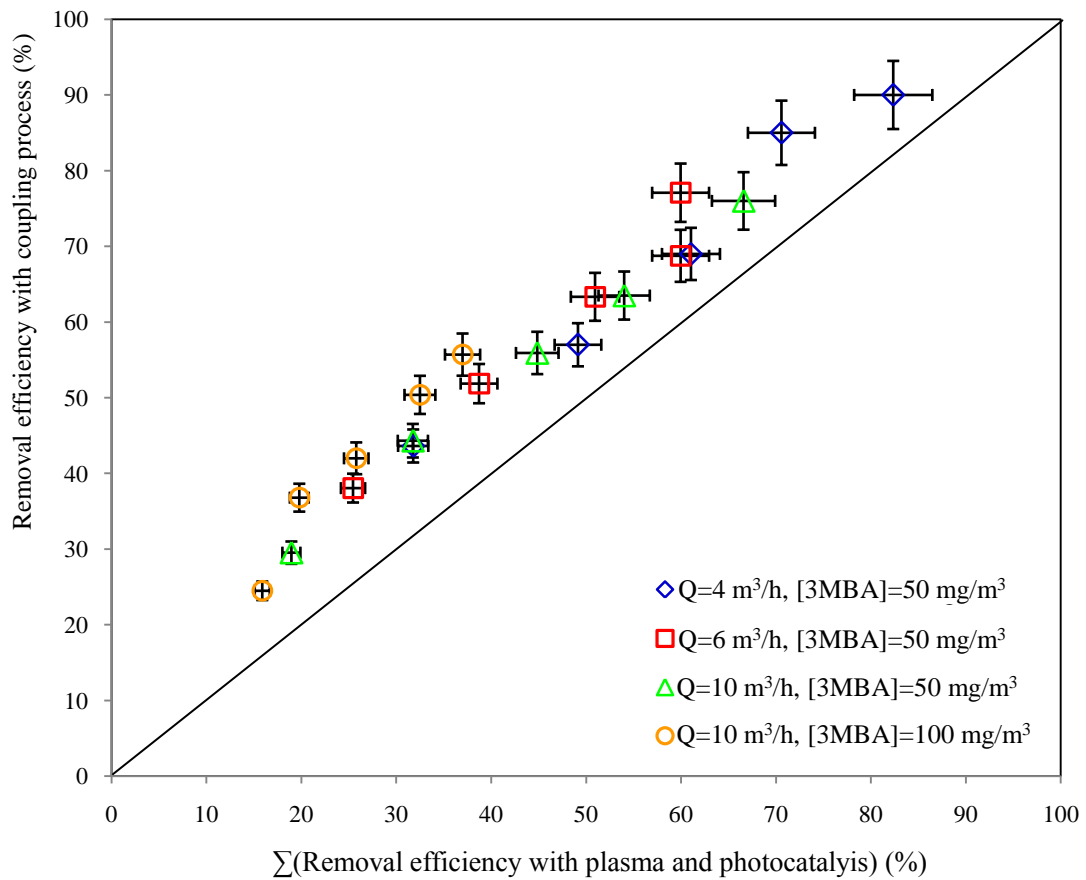

662

663 Figure.8: 3MBA removal efficiency by coupling process vs the sum of removal efficiency of
 664 plasma and photocatalysis at different residence time, inlet concentration and specific energy
 665 in planar reactor ($T=20 \text{ }^\circ\text{C}$, $\text{RH}=50 \%$, $I=20 \text{ W}\cdot\text{m}^{-2}$).

666

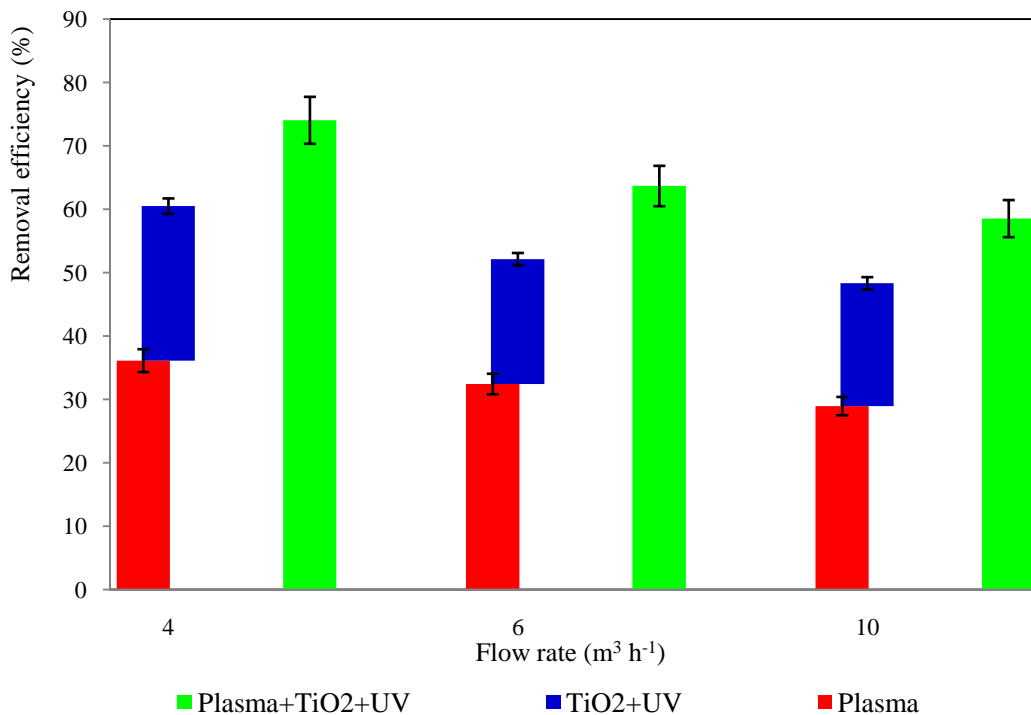

667

668 Figure 9: Trimethylamine conversion with flow rate for the different tested configurations

669

(SE=13 J.L⁻¹, [TMA] = 145 mg/m³, RH=50%, T= 20 °C).

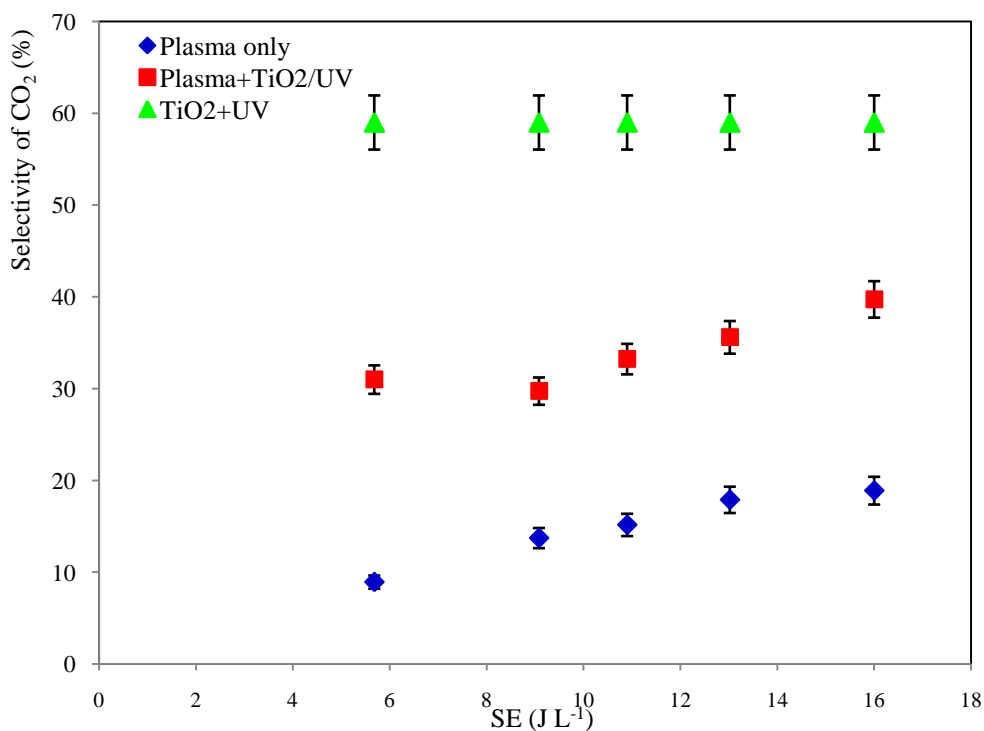

670

671 Figure 10: Variation of the overall selectivity of CO₂ vs. SE using the three processes

672

([3MBA] =50 mg.m⁻³, Q = 10 m³.h⁻¹, T= 20 °C, RH=50 %, I= 20 W.m⁻²).

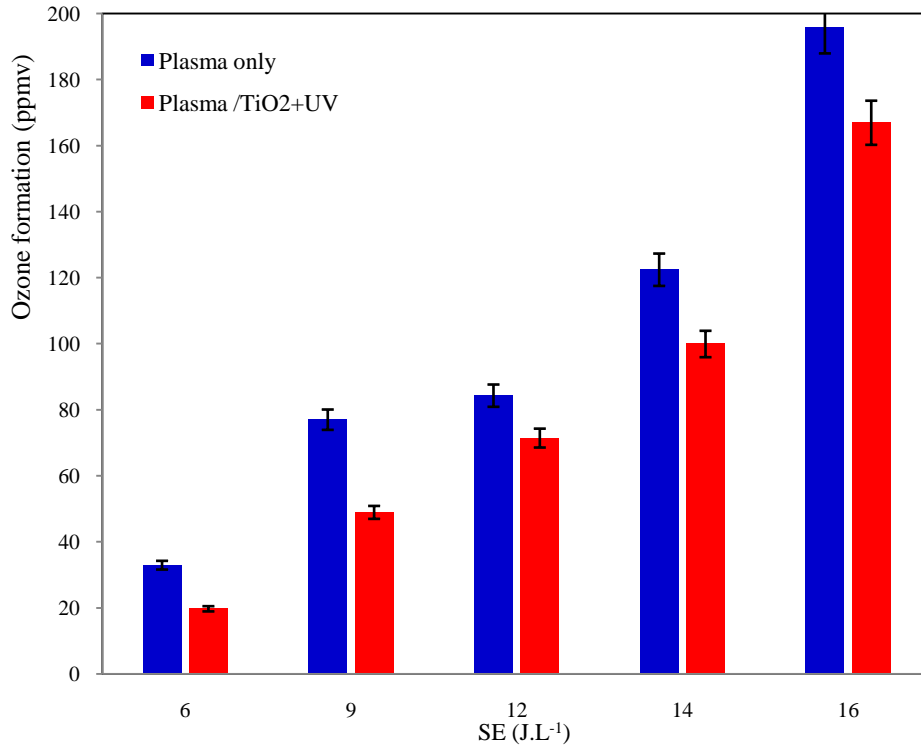

673

674

675

Figure 11: Variation of amount of ozone with the SE using two processes ($[3\text{MBA}] = 50 \text{ mg m}^{-3}$, $Q = 10 \text{ m}^3 \cdot \text{h}^{-1}$, $T = 20 \text{ }^\circ\text{C}$, $\text{RH} = 50 \%$, $I = 20 \text{ W} \cdot \text{m}^{-2}$).

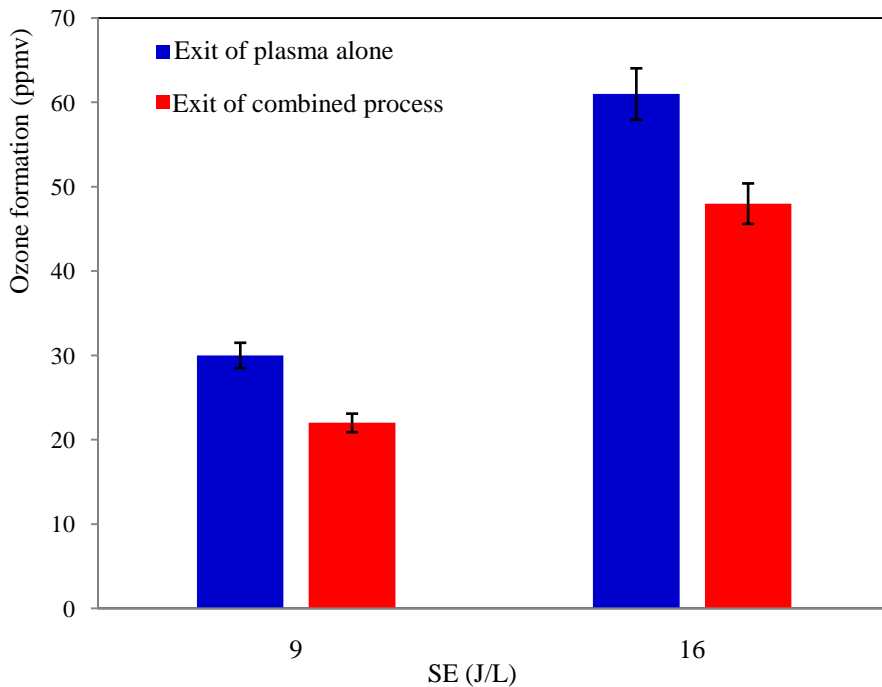

676

677

678

679

Figure 12: Variation of amount of ozone with the SE at exits of plasma alone and combined process in planar reactor ($[3\text{MBA}] = 50 \text{ mg} \cdot \text{m}^{-3}$, $Q = 10 \text{ m}^3 \cdot \text{h}^{-1}$, $T = 20 \text{ }^\circ\text{C}$, $\text{RH} = 50 \%$, $I = 20 \text{ W} \cdot \text{m}^{-2}$).