



HAL
open science

Full vehicle dynamics control based on LPV/Hinf and flatness approaches

Soheib Fergani, Lghani Menhour, Olivier Sename, Luc Dugard, Brigitte d'Andréa-Novel

► **To cite this version:**

Soheib Fergani, Lghani Menhour, Olivier Sename, Luc Dugard, Brigitte d'Andréa-Novel. Full vehicle dynamics control based on LPV/Hinf and flatness approaches. ECC 2014 - 13th European Control Conference, Jun 2014, Strasbourg, France. hal-00966904

HAL Id: hal-00966904

<https://hal.science/hal-00966904>

Submitted on 15 Nov 2017

HAL is a multi-disciplinary open access archive for the deposit and dissemination of scientific research documents, whether they are published or not. The documents may come from teaching and research institutions in France or abroad, or from public or private research centers.

L'archive ouverte pluridisciplinaire **HAL**, est destinée au dépôt et à la diffusion de documents scientifiques de niveau recherche, publiés ou non, émanant des établissements d'enseignement et de recherche français ou étrangers, des laboratoires publics ou privés.

Full vehicle dynamics control based on LPV/ \mathcal{H}_∞ and flatness approaches

S. Fergani^{1*}, L. Menhour², O. Sename¹, L. Dugard¹, B. D'Andrea Novel³

Abstract—This paper addresses an integration of two advanced vehicle controllers. The first one is developed for coupled control of longitudinal and lateral vehicle's motions. It takes advantage of differential flatness of nonlinear systems and algebraic identification techniques for denoising and numerical differentiation. The second one is an LPV/ \mathcal{H}_∞ controller for suspension system designed to adapt the vehicle vertical dynamics to the road profile and achieve performance objectives. This LPV/ \mathcal{H}_∞ aims, mainly, at improving the roadholding of the vehicle (by reducing the lateral load transfer and roll dynamics) or/and passengers comfort depending on the driving situation. Since the lateral forces acting on the vehicle influence the vertical ones (see (13)). The LPV/ \mathcal{H}_∞ control uses the lateral acceleration (controlled by the flatness controller) to schedule and enhance the vertical dynamic behaviour of the vehicle.

Such an integration is proposed in order to ensure an advanced vehicle control under critical driving conditions with different road profiles. This in order to improve the passengers comfort and the stability and steerability of the vehicle in different driving situations. The performance of the proposed strategy is shown through some simulation tests with different scenarios.

Keywords: LPV/ \mathcal{H}_∞ suspension control, vehicle dynamics behaviours, flatness nonlinear longitudinal and lateral control, algebraic identification methods.

I. INTRODUCTION

It is now admitted that the collaboration of several subsystems (active braking, steering, suspension...) is a key towards safer vehicles. However the studies were mainly separated in two categories:

- the longitudinal/lateral control (using traction, braking and steering actuators). For lane keeping, lane change, lane-change maneuvers, obstacle avoidance, a steering or lateral control is developed [1]–[4], and for stop-and-go, adaptive cruise control, platooning, a longitudinal control is designed [5]–[7]. Other coupled vehicle controllers for steering and braking control are developed in [8], [9].
- the vertical control using suspension systems [10], [11].

However the collaboration of the suspension system together with the braking or steering ones has only been a little

considered. Let us mention [12] where a new design of actuator intervention for trajectory tracking is proposed, [13] which gives an interesting nonlinear control law using suspension and braking actuators for commercial cars and in [14]–[16] where authors have proposed a Linear Parameter Varying (LPV) control structure that allows to coordinate several actuators and to improve different vehicle dynamics. This coordination is achieved using smart monitoring parameters that allow to modify on-line the performances of the suspension (from soft to hard) systems according to some critical situations (mainly too high longitudinal slips). However, such a coupling between the suspension control and the longitudinal/lateral one still remains a challenging problem.

This paper deals the global chassis control using a novel strategy that combines both flatness and LPV/ \mathcal{H}_∞ robust controllers. The contribution is two-fold:

- for the first time non linear and linear control strategies are used together for vehicle stability control. This work takes advantage of the efficiency of the flatness approach to control the longitudinal/lateral vehicle motion, and of the \mathcal{H}_∞ control to handle the car vertical dynamics.
- The collaboration between that two controllers will be handled using a vertical LPV controller scheduled by the car lateral acceleration.

The first part of the proposed controller is a combined nonlinear longitudinal and lateral vehicle control. For the proposed combined control strategy, the flatness property [17], [18] (see also [19]–[21] for a related approach) and the algebraic estimation techniques [22], [23] are used. Based on the adequate choice of the flat outputs, the flatness proof of a 3DoF two wheels vehicle model is established. Thereafter, the combined longitudinal and lateral vehicle control is designed. Moreover, such a control law takes advantage of the algebraic estimation techniques. This in order to have an accuracy estimation of the derivatives and filtering of the reference flat outputs. Such control strategy is developed in order to cope with coupled driving maneuvers like obstacle avoidance via steering control and stop-and-go control via braking or driving wheel torque.

The second part of the proposed strategy consists on the LPV/ \mathcal{H}_∞ suspension controller, which uses the lateral acceleration as a varying parameter to achieved the desired performance. Indeed, since the lateral dynamics act on the vertical ones through the lateral acceleration that influences directly the load transfer and roll dynamics of the vehicle see [24]. The vehicle stability can be clearly deduced

¹ GIPSA-lab, Control Systems Department, Grenoble University - Grenoble INP, ENSE³ - Domaine Universitaire BP46, 38402 Saint Martin d'Hères - Cedex France. olivier.sename@gipsa-lab.grenoble-inp.fr

² Centre de Recherche STIC, Institut Universitaire de Technologie de Troyes, 9, Rue du Québec, 10000 Troyes, France. lghani.menhour@univ-reims.fr

³ Mines-ParisTech, CAOR-Centre de Robotique, Mathématiques et systèmes, 60 boulevard Saint-Michel, 75272 Paris cedex 06, France. brigitte.dandrea-novel@mines-paristech.fr

* This work was supported by the French national project INOVE/ ANR 2010 BLAN 0308. Corresponding author: olivier.sename@gipsa-lab.grenoble-inp.fr

from the evolution of the lateral acceleration, since when the lateral acceleration increases the vehicle is less stable and vice versa. Moreover, the proposed LPV/ \mathcal{H}_∞ control strategy uses this information to schedule the work of the suspension systems, i.e, set them to be "hard" to emphasises the roadholding, passengers safety and the stability of the vehicle in dangerous driving situations, or set them to be "soft" to enhance vehicle passengers comfort and compensate road irregularities shocks.

The paper is organized as follows. Section II is devoted to present the design method of the LPV/ \mathcal{H}_∞ suspension and flat nonlinear longitudinal/lateral controllers. In Section IV, the performance of the proposed control strategy are shown through simulation results. Finally, conclusions and future works are stated in Section IV.

II. FLAT NONLINEAR LONGITUDINAL/LATERAL AND LPV/ \mathcal{H}_∞ SUSPENSION CONTROLLERS

In this section, design methods of two advanced vehicle controllers and their integration are given. The differential flatness and the LPV/ \mathcal{H}_∞ approaches are used to deal with this implementation as follow:

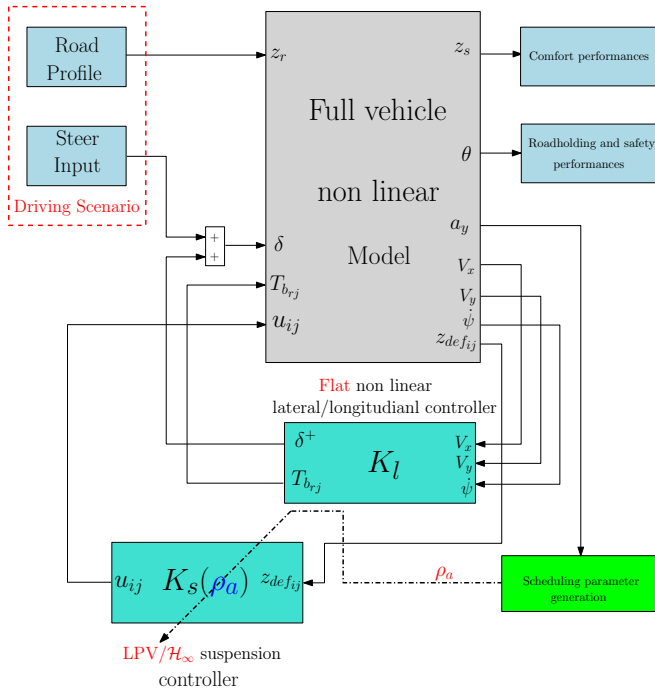

Fig. 1. Global chassis control integration strategy.

Indeed, the non linear flatness controller given in this strategy allows to enhance vehicle stability by improving longitudinal and especially lateral dynamics. In a smart way, the LPV/ \mathcal{H}_∞ uses the correlation between the lateral and vertical effort applied to the vehicle by scheduling the work of the suspension systems to archived the desired performance objectives.

A. Longitudinal and lateral based-flatness nonlinear control design

In the sequel, a 3DoF single-track nonlinear vehicle model and a nonlinear flat vehicle control are presented. The coupled flat control is designed according to the flatness property of the 3DoF-NLTWVM and the algebraic estimation techniques. Moreover, some simulation tests are conducted using a second nonlinear four wheels vehicle model¹ as complet vehicle simulator.

Paper notation:

TABLE I
SOME NOTATIONS

Symbol	Variable name
V_x, V_y	longitudinal and lateral speeds [km.h]
a_x, a_y	longitudinal and lateral accelerations [m/s^2]
$\psi, \dot{\psi}$	yaw angle [rad] and yaw rate [rad/s]
ω_i	wheel angular speed of the wheel i [rad/s]
T_ω	wheel torque [Nm]
T_m	wheel traction torque [Nm]
T_b	wheel braking torque [Nm]
T_{bf}	front wheel braking torque [Nm]
T_{br}	rear wheel braking torques [Nm]
δ	wheel steer angle [deg]
C_f, C_r	front and rear cornering stiffnesses [$N.rad^{-1}$]
$F_{(x,y)i}$	longitudinal and lateral forces in the vehicle coordinate [N]
$F_{(x,y)}$	longitudinal and lateral forces in the wheel coordinate [N]
M_z	yaw moment [Nm]
R	tire radius [m]
L_f, L_r	distances from the CoG to the front and rear axles [m]
I_z	yaw moment of inertia [$Kg.m^{-2}$]
I_r	wheel moment of inertia [kgm^2]
α_i	tire slip angle [rad]
g	acceleration due to gravity [m/s^2]
m	vehicle mass [kg]
$m_{us_{fj}}$	four wheels mass (front and rear are different) [kg]
t_f, t_r	front, rear axle [m]
k_i	stiffness coefficients
$F_{sz_{ij}}$	vertical forces [N]
\ddot{z}_s	chassis acceleration [m/s^2]
\ddot{z}_s	four wheels acceleration [m/s^2]
$\dot{\theta}$	roll dynamics
$\dot{\phi}$	pitch dynamics

1) 3DoF Nonlinear Two Wheels Vehicle Control Model:

The 3DoF single-track nonlinear model provides a sufficient approximation of the longitudinal and lateral dynamics. The 3DoF which composed such a model are: longitudinal, lateral and yaw motions². The nonlinear equations governing this model are:

¹The second model is composed of ten degrees-of-freedom which are: three rotational motions (roll ϕ , pitch θ and yaw ψ), three translational motions (longitudinal V_x , lateral V_y and vertical V_z) and dynamical models of four wheels. In this model, the forces are computed with coupled nonlinear tire model of Pacejka [25] to simulate the realistic behavior of vehicle. In fact, this model takes into account the coupling of vertical, longitudinal and lateral motions. See [20] for more details on this model.

²see table I for notations.

$$\dot{x} = f(x,t) + g(x)u + g_1u_1u_2 + g_2u_2^2 \quad (1)$$

where

$$f(x,t) = \begin{bmatrix} \psi V_y - \frac{I_r}{mR}(\dot{\omega}_r + \dot{\omega}_f) \\ -\psi V_x + \frac{1}{m} \left(-C_f \left(\frac{V_y + L_f \psi}{V_x} \right) - C_r \left(\frac{V_y - L_r \psi}{V_x} \right) \right) \\ \frac{1}{I_z} \left(-L_f C_f \left(\frac{V_y + L_f \psi}{V_x} \right) + L_r C_r \left(\frac{V_y - L_r \psi}{V_x} \right) \right) \end{bmatrix},$$

$$g(x,t) = \begin{bmatrix} \frac{1}{mR} & \frac{C_f}{m} \left(\frac{V_y + L_f \psi}{V_x} \right) \\ 0 & (C_f R - I_r \dot{\omega}_f) / mR \\ 0 & (L_f C_f R - L_r I_r \dot{\omega}_f) / I_z R \end{bmatrix}, \quad x = \begin{bmatrix} V_x \\ V_y \\ \psi \end{bmatrix}$$

and $u = [u_1 \ u_2]^T$

where the longitudinal movement is controlled via the wheel torque $u_1 = T_\omega = T_m - T_b$ and the lateral movement is controlled via the steering angle $u_2 = \delta$. The second order terms u_1u_2 and u_2^2 are neglected because their magnitude is small. For more explanations about this model, we refer the readers to [19], [20].

2) *Coupled longitudinal/lateral vehicle control based on flatness property:*

For our design problem, we consider the following outputs:

$$\begin{cases} y_1 = V_x \\ y_2 = L_f m V_y - I_z \psi \end{cases} \quad (2)$$

For the flatness proof of (1) with the outputs (2), the following flatness property [17], [18], [26], [27] is considered:

Property 1: Consider the system

$$\dot{x} = f(x,u) \quad (3)$$

where $x = (x, \dots, x_n) \in \mathbb{R}^n$ and $u = (u, \dots, u_m) \in \mathbb{R}^m$. It is said to be *differentially flat* (see [17], [18], [26], [27]) if and only if there exists a vector-valued function h such that

$$y = h(x, u, \dot{u}, \dots, u^{(r)}) \quad (4)$$

where $y = (y, \dots, y_m) \in \mathbb{R}^m$, $r \in \mathbb{N}$; the components of $x = (x, \dots, x_n)$ and $u = (u, \dots, u_m)$ may be expressed as

$$x = A(y, \dot{y}, \dots, y^{(r_x)}), \quad r_x \in \mathbb{N} \quad (5)$$

$$u = B(y, \dot{y}, \dots, y^{(r_u)}), \quad r_u \in \mathbb{N} \quad (6)$$

then, the output (4) is called a flat output.

Proof 1: The objective is to show the flatness of model (1) with outputs (2) according to the flatness property 1. Then, after some algebraic manipulations we obtain:

$$x = \begin{bmatrix} y_1 \\ \frac{1}{L_f m} \left(y_2 - \frac{I_z L_f m y_1 \dot{y}_2 + I_z C_r (L_f + L_r) y_2}{C_r (L_f + L_r) (I_z - L_r L_f m) + (L_f m y_1)^2} \right) \\ - \left(\frac{L_f m y_1 \dot{y}_2 + C_r (L_f + L_r) y_2}{C_r (L_f + L_r) (I_z - L_r L_f m) + (L_f m y_1)^2} \right) \end{bmatrix} \quad (7)$$

and

$$u = \Delta^{-1}(y_1, y_2, \dot{y}_2) \left(\begin{bmatrix} \dot{y}_1 \\ \dot{y}_2 \end{bmatrix} - \Phi(y_1, y_2, \dot{y}_2) \right) \quad (8)$$

The terms Δ_{11} , Δ_{12} , Δ_{21} , Δ_{22} , Φ_1 and Φ_2 of the matrices Δ and Φ are detailed in [19], [20]. Finally, the system (1) is flat system with outputs (2), then, the outputs (2) are called flat outputs.

Then, it is interesting to control y_1 and y_2 via the control signals $u_1 = T_\omega$ and $u_2 = \delta$. So, in order to track the desired output y_1^{ref} and y_2^{ref} , set

$$\begin{bmatrix} \dot{y}_1 \\ \dot{y}_2 \end{bmatrix} = \begin{bmatrix} y_1^{ref} + K_1^1 e_{y_1} + K_1^2 \int e_{y_1} dt \\ y_2^{ref} + K_2^1 \dot{e}_{y_2} + K_2^2 e_{y_2} + K_2^3 \int e_{y_2} dt \end{bmatrix} \quad (9)$$

where, $e_{y_1} = y_1^{ref} - y_1$ and $e_{y_2} = y_2^{ref} - y_2$. The choice of the gain parameters K_1^1 , K_1^2 , K_2^1 , K_2^2 and K_2^3 is straightforward.

3) *Algebraic nonlinear estimation:*

The filtering and the derivatives of the reference flat outputs are needed to construct the control law (9). However, the derivation of noisy reference flat outputs becomes a very difficult operation. Such an operation is achieved thanks to the recent advances in [22], [23], which yield efficient real-time filters. For our study, the following formulae may be used to estimate the 1st order derivative of y :

$$\hat{y}(t) = -\frac{3!}{h^3} \int_{t-h}^t (2h(t-\tau) - h) y(\tau) d\tau \quad (10)$$

and the filtering of y is estimated using:

$$\hat{y}(t) = \frac{2!}{h^2} \int_{t-h}^t (3(t-\tau) - h) y(\tau) d\tau \quad (11)$$

Note that the sliding time window $[t-h, t]$ may be quite short.

Finally, the block diagram of Figure 2 summarize all parts of the flat nonlinear vehicle control.

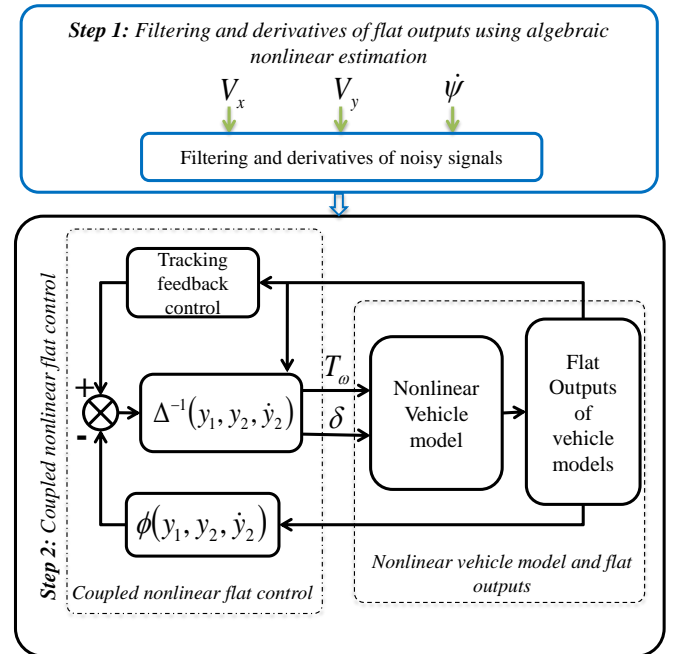

Fig. 2. Trajectories: reference, controlled and uncontrolled models

$$\begin{cases} \ddot{z}_s &= -(F_{sz_f} + F_{sz_r} + F_{dz})/m \\ \ddot{z}_{us_{ij}} &= (F_{sz_{ij}} - F_{tz_{ij}})/m_{us_{ij}} \\ \ddot{\theta} &= ((F_{sz_{rl}} - F_{sz_{rr}})t_r + (F_{sz_{fl}} - F_{sz_{fr}})t_f + mh\dot{v}_y)/I_x \\ \ddot{\phi} &= (F_{sz_{fl}}l_f - F_{sz_{rl}}l_r - mh\dot{v}_x)/I_y \end{cases} \quad (12)$$

B. LPV/ \mathcal{H}_∞ suspension control design

1) *Control-structure model*: The LPV/ \mathcal{H}_∞ suspension control is synthesized on a 7 DOF vehicle model, see (12). It includes several vertical dynamics as the chassis acceleration \ddot{z}_s , the four wheels accelerations $\ddot{z}_{us_{ij}}$, the roll bounce acceleration $\ddot{\theta}$ and the pitch acceleration $\ddot{\phi}$. For the control design purposes, linear models are assumed for the stiffness k_{ij} and damping c_{ij} in the suspension force computation.

Scheduling parameters:

A smart way for the two vehicle dynamics controllers integration is achieved thanks to the scheduling parameter ρ_a used for the LPV/ \mathcal{H}_∞ suspension control design as in Fig. 1. Indeed, the lateral and the vertical dynamics of the vehicle are correlated through lateral and vertical forces as follow, see [28]:

$$F_{iy}(\beta_i) = \text{Sign}(\beta_i)F_{iz}\mu(\beta_i) \quad (13)$$

where F_{iy} : is the lateral tire force, β_i : is the sideslip angle, F_{iz} : is the vertical force and $\mu(\beta_i)$: is the road friction.

Furthermore, this relation can be seen also in the vehicle load transfers and roll dynamics that depend on the lateral acceleration a_y (notice that $F_y = m_s a_y \alpha$, where α : is a constant coefficient) as follow, see [24] and [29]:

$$\begin{aligned} \Delta F_z &= (F_{z_{fl}} + F_{z_{rl}} - F_{z_{fr}} - F_{z_{rr}}) \\ &= (m_{fl} + m_{rl} - m_{fr} - m_{rr})g - 2S_1\theta \\ &\quad - 2S_2 a_y m/l \end{aligned} \quad (14)$$

where $S_1 = \frac{k_f}{t_f} + \frac{k_r}{t_r}$, $S_2 = \frac{l_f h}{t_f} + \frac{l_r h}{t_r}$. It is clear that the load transfers generated by the vehicle bounce are largely influenced by the dynamics of the lateral acceleration, especially since the roll motion is also directly linked to a_y as follow (see [28] and [30]):

$$\theta = \frac{z_{def_{fl}} - z_{def_{fr}} + z_{def_{rl}} - z_{def_{rr}}}{t_f} - \frac{m a_y h}{k_t} \quad (15)$$

where $z_{def_{ij}}$: is the suspension deflections (i: left or rear, j: left or right), k_t : is the stiffness.

The varying parameter used in this strategy is then based on the lateral acceleration. The performance adaptation induced in the weighing are scheduled thanks to the parameter $\rho_a \in [0 \ 1]$, defined as follow:

$$\rho_a = \left| \frac{a_y}{a_{y\max}} \right| \quad (16)$$

2) *LPV/ \mathcal{H}_∞ controller design*: The suspension control with performance adaptation (see [31]) is presented. The following H_∞ control scheme is considered, including parameter varying weighting functions.

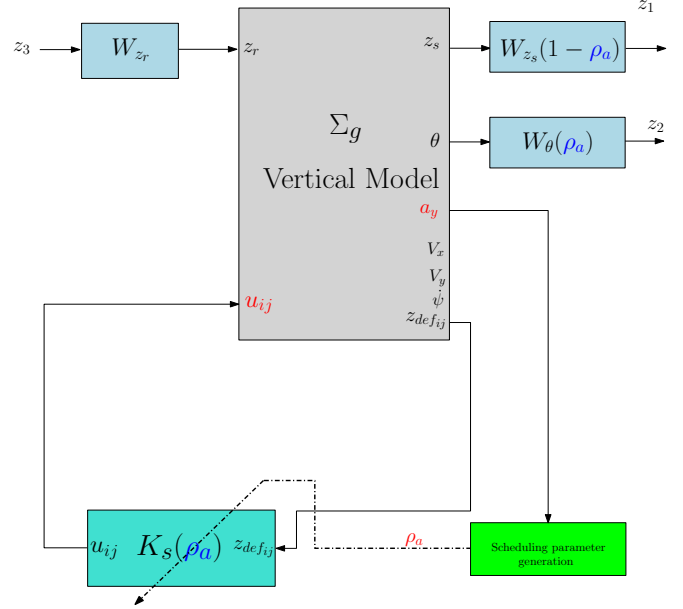

Fig. 3. General scheme of the LPV/ \mathcal{H}_∞ suspension control.

where $W_{z_s} = 1 - \rho_a \frac{s^2 + 2\xi_{11}\Omega_{11}s + \Omega_{11}^2}{s^2 + 2\xi_{12}\Omega_{12}s + \Omega_{12}^2}$ is shaped in order to reduce the bounce amplification of the suspended mass (z_s) between $[0, 12]$ Hz.

$W_\theta = (\rho_a) \frac{s^2 + 2\xi_{21}\Omega_{21}s + \Omega_{21}^2}{s^2 + 2\xi_{22}\Omega_{22}s + \Omega_{22}^2}$ attenuates the roll bounce amplification in low frequencies.

$W_u = 3 \cdot 10^{-2}$ shapes the control signal.

Remark 2.1: The parameters of these weighting functions are obtained using genetic algorithm optimization as in [32].

According to Fig. 3, the following parameter dependent suspension generalized plant ($\Sigma_{gv}(\rho_a)$) is obtained:

$$\Sigma_{gv}(\rho_a) := \begin{cases} \dot{\xi} = A(\rho_a)\xi + B_1\tilde{w} + B_2u \\ \tilde{z} = C_1(\rho_a)\xi + D_{11}\tilde{w} + D_{12}u \\ y = C_2\xi + D_{21}\tilde{w} + D_{22}u \end{cases} \quad (17)$$

where $\xi = [\chi_{vert} \ \chi_w]^T$; $\tilde{z} = [z_1 \ z_2 \ z_3]^T$; $\tilde{w} = [z_{rij} \ F_{dx,y,z} \ M_{dx,y}]^T$; $y = z_{def_{ij}}$; $u = u_{ij}$; and χ_w are the vertical weighting functions states.

The proposed LPV/ \mathcal{H}_∞ robust controller is synthesized by using *LMI*s solution for polytopic systems; the varying parameter ρ_a is considered bounded: $\rho_a \in [0, 1]$.

To summarize, when the driving situation is dangerous, the vehicle stability is weak and lateral acceleration increases: $\rho_a \rightarrow 1$, the roll motion caused is penalized to reduce the load transfer bounce as in Fig. 3 to enhance roadholding, stability and safety of the vehicle.

In normal driving situations, the lateral acceleration is low and $\rho_a \rightarrow 0$. In this case, the LPV/ \mathcal{H}_∞ suspension control focuses on improving passengers comfort by reducing the chassis displacement and accelerations.

III. SIMULATION RESULTS

Fig. 4, 5 and 6 present the simulation results obtained with the flat nonlinear control strategy. A line change maneuver is used to perform this test. This results confirm the ability of this control law to follow a given trajectory. In fact, Fig. 5 shows the performance results of the flat controller to track the desired flat outputs y_1 and y_2 . Moreover, the abilities of this control law to provide coupled and realistic control maneuvers in terms of steering angle and braking torque are presented in Fig. 4.

Other results on the stability of the sideslip motion of the vehicle are presented in Fig. 6. In fact, the controlled vehicle model operates inside of the stability region, however, the uncontrolled model operates outside the stability region. These results confirm the ability of the proposed flat control law to keep the controlled vehicle model more stable.

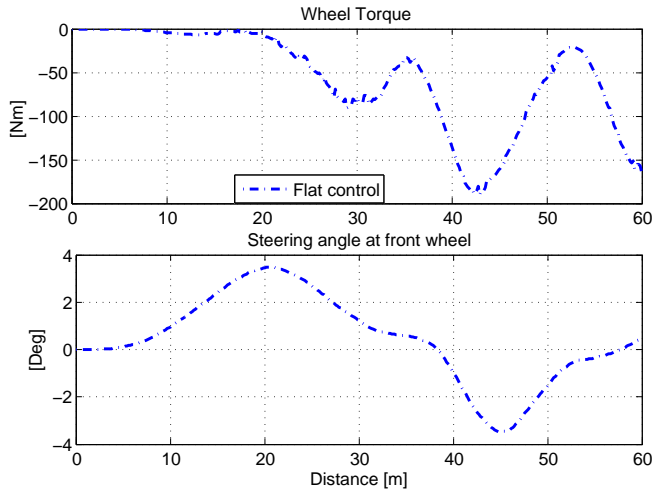

Fig. 4. Coupled longitudinal/lateral flat control signals

The scenario is used to emphasize the integration strategy between the flat non linear longitudinal/lateral dynamics control and the LPV/ \mathcal{H}_∞ vertical dynamic control: the vehicle is considered running at 90km/h in straight line on wet road ($\mu = 0.5$, where μ is a coefficient representing the adherence to the road). The driver performs a line change manoeuvre between $t = 0.5s$ and $t = 2s$. First, a 5cm bump occurs on the left wheels (from $t = 0.5s$ to $t = 1s$) then another one between $t = 3s$ and $t = 4s$. Also, lateral winds are considered generating an undesirable yaw moment (from

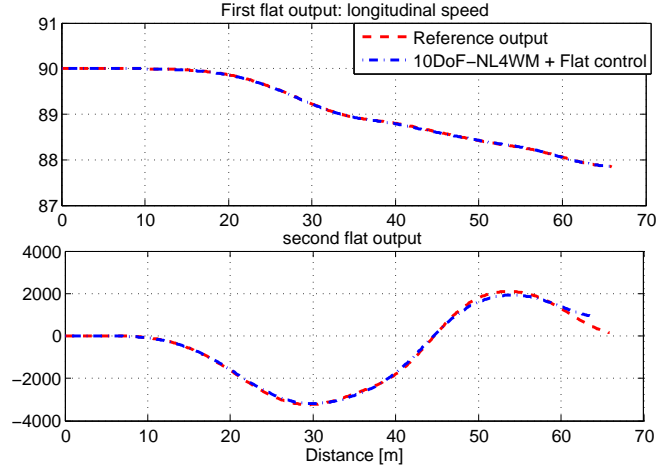

Fig. 5. Flat outputs: reference and controlled model

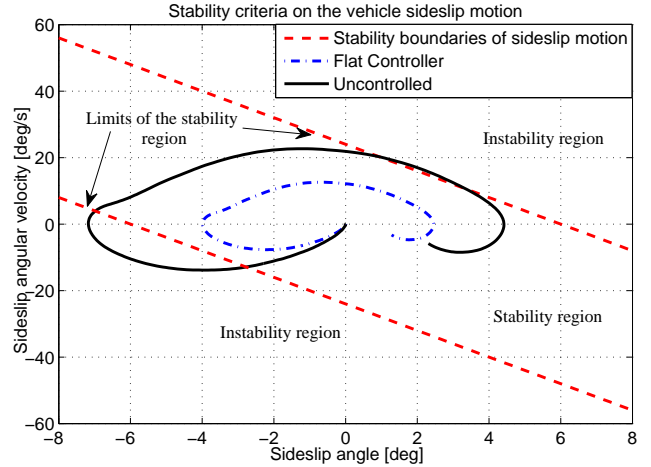

Fig. 6. Stability criteria of sideslip motion: controlled and uncontrolled vehicle models

$t = 2s$ to $t = 2.5s$).

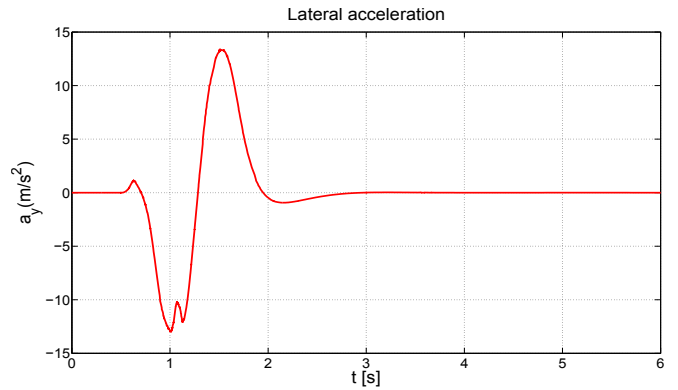

Fig. 7. Lateral acceleration

Fig. 7 and Fig. 8 show the lateral acceleration of the vehicle and the scheduling parameter used by the LPV/ \mathcal{H}_∞ ,

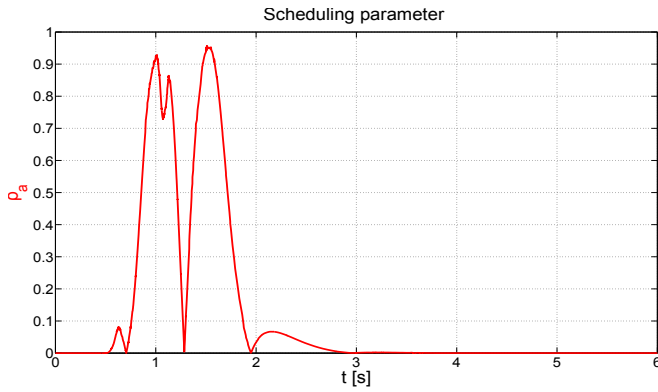

Fig. 8. Scheduling parameter ρ_a

respectively, while performing the proposed scenario. It can be seen that the lateral acceleration rises when performing the line change maneuver (lateral dynamics strongly excited), at the same time the considered varying parameter ρ_a value increases to achieved properly the performance scheduling task.

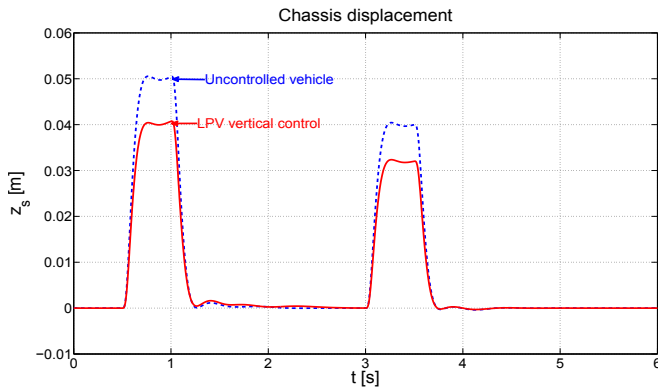

Fig. 9. Chassis displacement

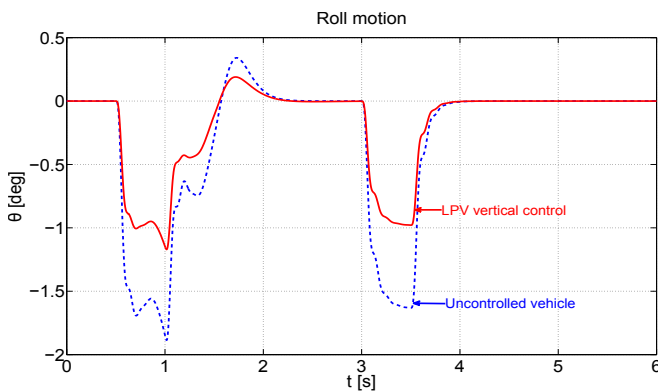

Fig. 10. Chassis displacement

The chassis displacement (representing passengers comfort) and roll bounce motion of the vehicle (representing

the vehicle roadholding) are given by Fig. 9 and Fig. 10. Indeed, when the driver performs the line change and faces the first bump, the driving situation is dangerous and the lateral acceleration increases (as in Fig. 7), $\rho_a \rightarrow 1$ (as shown in Fig. 8) to tune the suspension control. In this case, the LPV/ \mathcal{H}_∞ suspension control penalizes more the roll dynamics to reduce the load transfer and improve the vehicle safety and handling (see II-B.2). Also, it can be seen in Fig. 9 that after the line change, when the vehicle encounters the bump in a straight road, the driving situation is normal, $\rho_a \rightarrow 0$ and the suspension control focuses on improving passengers comfort by reducing the chassis displacement z_s .

IV. CONCLUSIONS AND FUTURE WORK

This paper has presented a novel integration strategy of non linear and robust vehicle control approaches: the lateral/longitudinal flatness control and the LPV/ \mathcal{H}_∞ vertical dynamics control. An innovative coordination method between the two strategies has been introduced ensuring a good communication between the considered controllers that aims at improving several vehicle dynamics. Simulation results emphasize the success of this collaborative strategy for enhancing the longitudinal, lateral and vertical dynamics and have shown the efficiency of the proposed approach. The authors stress that using the LPV coordination framework allows to simplify the implementation procedure.

REFERENCES

- [1] R. Rajamani, H.-S. Tan, B.-K. Law, and W.-B. Zhang, "Demonstration of integrated longitudinal and lateral control for the operation of automated vehicles in platoons." *IEEE Transactions on Control Systems Technology*, vol. 8, 2000.
- [2] J. Ackermann, J. Guldner, W. Sienel, R. Steinhauser, and V. I. Utkin, "Linear and nonlinear controller design for robust automatic steering." *IEEE Transactions on Control Systems Technology*, vol. 3, 1995.
- [3] V. Cerone, M. Milanese, and D. Regruto, "Combined automatic lane-keeping and driver's steering through a 2-dof control strategy." *IEEE Transactions on Control Systems Technology*, vol. 17, 2009.
- [4] D. F. Llorca, V. Milanese, I. P. Alonso, M. Gavilan, I. G. Daza, J. Perez, and M. A. Sotelo, "Autonomous pedestrian collision avoidance using a fuzzy steering controller." *IEEE Transactions on Intelligent Transportation Systems*, vol. 12(2), 2011.
- [5] J. Martinez and C. C. de Wit, "A safe longitudinal control for adaptive cruise control and stop-and-go scenarios." *IEEE Transactions on Control Systems Technology*, vol. 15, 2007.
- [6] S. Mammari and M. Netto, "Integrated longitudinal and lateral control for vehicle low speed automation," in *IEEE ICCA*, Taiwan, 2004.
- [7] J. Villagra, B. d'Andréa Novel, S. Choi, M. Fliess, and H. Mounier, "Robust stop-and-go control strategy: an algebraic approach for non-linear estimation and control." *IEEE Transactions on Control Systems Technology*, vol. 7, 2009.
- [8] C. Poussot-Vassal, O. Sename, L. Dugard, P. Gáspár, Z. Szabó, and J. Bokor, "Vehicle dynamic stability improvements through gain-scheduled steering and braking control," *Control Engineering Practice*, vol. 49, pp. 1597–1621, 2011.
- [9] S. Zheng, Z. H. Ho Tang, and Y. Zhang, "Controller design for vehicle stability enhancement," *Control Engineering Practice*, vol. 14, pp. 1413–1421, 2006.
- [10] A. Zin, O. Sename, P. Gaspar, L. Dugard, and J. Bokor, "Robust LPV - \mathcal{H}_∞ control for active suspensions with performance adaptation in view of global chassis control," *Vehicle System Dynamics*, vol. 46, no. 10, pp. 889–912, October 2008.
- [11] A. Zin, O. Sename, and L. D. a, "A feedback-feedforward suspension control strategy for global chassis control through anti-roll distribution." *Int. J. of Vehicle Autonomous Systems*, vol. 7, no. 3/4, pp. 201–220, 2009.

- [12] B. Németh and P. Gáspár, "Design of actuator interventions in the trajectory tracking for road vehicles," in *Proceedings of the 51th IEEE Conference on Decision and Control (CDC)*, Orlando, Florida, USA, December 2011.
- [13] H. Chou and B. d'Andréa Novel, "Global vehicle control using differential braking torques and active suspension forces," *Vehicle System Dynamics*, vol. 43, no. 4, pp. 261–284, April 2005.
- [14] P. Gáspár, Z. Szabó, J. Bokor, C. Poussot-Vassal, O. Sename, and L. Dugard, "Toward global chassis control by integrating the brake and suspension systems," in *Proceedings of the 5th IFAC Symposium on Advances in Automotive Control (AAC)*, Aptos, California, USA, August 2007.
- [15] S. Fergani, O. Sename, and L. Dugard, "A LPV/ \mathcal{H}_∞ global chassis controller for performances improvement involving braking, suspension and steering systems," in *Proceedings of the 7th IFAC Symposium on Robust Control Design*, Aalborg, Denmark, June 2012.
- [16] —, "Performances improvement through an LPV/ \mathcal{H}_∞ control coordination strategy involving braking, semi-active suspension and steering systems," in *Proceedings of the 51th IEEE Conference on Decision and Control (CDC)*, Maui, Hawaii, Denmark, December 2012.
- [17] M. Fliess, J. Lévine, P. Martin, and P. Rouchon, "Flatness and defect of nonlinear systems: introductory theory and examples," *International Journal of Control*, vol. 61, pp. 1327–1361, 1995.
- [18] —, "A lie-bäcklund approach to equivalence and flatness of nonlinear systems," *IEEE Trans. Automat. Control*, vol. 44, pp. 922–937, 1999.
- [19] L. Menhour, B. d'Andréa Novel, C. Boussard, M. Fliess, and H. Mounier, "Algebraic nonlinear estimation and flatness-based lateral/longitudinal control for automotive vehicles," in *Proceedings of the 14th Int. IEEE Conf. ITS*, Washington, usa, 2011.
- [20] —, "Coupled nonlinear vehicle control: Flatness-based setting with algebraic estimation techniques," *Control Engineering Practice (to appear)*, 2013.
- [21] S. Fuchshumer, K. Schlacher, and T. Rittenschöber, "Nonlinear vehicle dynamics control - a flatness based approach," in *Proceedings of the 44th IEEE CDC & ECC*, Sevilla, 2005.
- [22] M. Fliess, C. Join, and H. Sira-Ramírez, "Non-linear estimation is easy," *Int. J. Model. Identif. Control*, vol. 4, pp. 12–27, 2008.
- [23] M. Mboup, C. Join, and M. Fliess, "Numerical differentiation with annihilators in noisy environment," *Numer. Algor.*, vol. 50, pp. 439–467, 2009.
- [24] R. Anderson, "Using gps for model based estimation of critical vehicle states," Master's thesis, Auburn University, Alabama, December 2004.
- [25] H. B. Pacejka, *Tire and Vehicle Dynamics*. Elsevier, 2004.
- [26] J. Lévine, *Analysis and Control of Nonlinear Systems – A Flatness-based Approach*. Springer, 2009.
- [27] H. Sira-Ramírez and S. Agrawal, *Differentially Flat Systems*. Marcel Dekker, 2004.
- [28] T. Brown, A. Hac, and J. Martens, "Detection of vehicle rollover," in *SAE World Congress*, Michigan-Detroit, December 2004.
- [29] W. Milliken and D. Milliken, *Race car vehicle dynamics*. Society of Automotive Engineers, Inc, 1995.
- [30] N. RAO, "An approach to rollover stability in vehicles using suspension relative sensors and lateral acceleration sensors," Master's thesis, Texas A & M University, Texas, December 2005.
- [31] S. Savaresi, C. Poussot-Vassal, C. Spelta, O. Sename, and L. Dugard, *Semi-Active Suspension Control for Vehicles*. Elsevier - Butterworth Heinemann, 2010.
- [32] A. L. Do, O. Sename, and L. Dugard, "LPV modeling and control of semi-active in automotive systems", 15th chapter, pp381 – 411, in "Control of Linear Parameter Varying Systems with Applications", C. Scherer and J. Mohammadpour, Eds. Springer, New-York,.