



HAL
open science

Fulleroids with dihedral symmetry

František Kardoš

► **To cite this version:**

František Kardoš. Fulleroids with dihedral symmetry. *Discrete Mathematics*, 2010, 310 (3), pp.652-661. hal-00966748

HAL Id: hal-00966748

<https://hal.science/hal-00966748>

Submitted on 27 Mar 2014

HAL is a multi-disciplinary open access archive for the deposit and dissemination of scientific research documents, whether they are published or not. The documents may come from teaching and research institutions in France or abroad, or from public or private research centers.

L'archive ouverte pluridisciplinaire **HAL**, est destinée au dépôt et à la diffusion de documents scientifiques de niveau recherche, publiés ou non, émanant des établissements d'enseignement et de recherche français ou étrangers, des laboratoires publics ou privés.

Fulleroids with Dihedral Symmetry

František Kardoš^{*}

Institute of Mathematics, P. J. Šafárik University, Jesenná 5, 041 54 Košice, Slovakia

Abstract

Fulleroids are cubic convex polyhedra with faces of size 5 or greater. They are suitable as models of hypothetical all-carbon molecules. In this paper sufficient and necessary conditions for existence of fulleroids of dihedral symmetry types and with pentagonal and n -gonal faces only depending on number n are presented. Either infinite series of examples are found to prove existence, or nonexistence is proved using symmetry invariants.

Key words: Fullerene graph; Fulleroid; Symmetry group; Dihedral symmetry

1. Introduction

Fullerenes have been objects of interest and study in the past two decades. A *fullerene* is a 3-valent carbon molecule, where atoms are arranged in pentagons and hexagons. It can be seen as a convex polyhedron, where vertices represent atoms and edges represent bonds between atoms. Fullerenes can also be represented by graphs. In fact, a *fullerene graph* is a planar, cubic (i.e. 3-regular) and 3-connected graph, twelve of whose faces are pentagons and the remaining faces are hexagons.

The concept of fullerenes can be generalized in several ways. Fowler [6] asked whether a fullerene-like structure consisting of pentagons and heptagons only and exhibiting an icosahedral symmetry exists. The answer was given by Dress and Brinkmann [2]. Motivated by these examples Delgado Friedrichs and Deza [4] introduced the following definition:

Definition 1 A fulleroid is a convex polyhedron such that all its vertices have degree 3 while all its faces have degree 5 or larger. A Γ -fulleroid is a fulleroid on which the group Γ acts as a group of symmetries. A given Γ -fulleroid is of type (a, b) or a $\Gamma(a, b)$ -fulleroid if all its faces are either a -gonal or b -gonal.

The set of all $\Gamma(a, b)$ -fulleroids will be denoted simply by $\Gamma(a, b)$.

There is a list of groups, that can act as a symmetry group of a convex polyhedron [3]. According to the system of rotational symmetry axes they can be divided into icosahedral, octahedral, tetrahedral, dihedral, cyclic and others.

Symmetry of fullerenes has been studied deeply. The possible symmetry groups Γ for fullerenes were shown to be limited to a total of 28 point groups [5]. Babić, Klein and Sah [1] divided all fullerenes with up to 70 vertices according to the symmetry group. Fowler and Manolopoulos [6] found symmetry groups of all fullerenes with up to 100 vertices. For each symmetry group Γ they found the smallest Γ -fullerene and the

^{*} This work was supported by the Slovak VEGA Grant 1/3004/06 and AVPT-20-004104 Grant.
Email address: frantisek.kardos@upjs.sk (František Kardoš).

smallest Γ -fullerene obeying IPR (isolated pentagon rule). They described how to create a new fullerene with the same symmetry group having more hexagonal faces and obeying IPR once a fullerene is given. Graver [7] published a catalogue of all fullerenes with ten or more symmetries.

Symmetry of fullerooids has also been an object of research in recent years. Among all possible symmetry types, icosahedral symmetry groups were studied first. Let the full symmetry group of a regular icosahedron be denoted by \mathcal{I}_h ; its subgroup of rotational symmetries by \mathcal{I} . Delgado Friedrichs and Deza [4] found $\mathcal{I}_h(5, n)$ -fullerooids for $n = 8, 9, 10, 12, 14$ and 15 and asked several questions concerning $\mathcal{I}(5, n)$ -fullerooids. Most of their questions were answered by Jendroř and Trenkler [9], who found infinite series of examples of $\mathcal{I}(5, n)$ -fullerooids for all $n \geq 8$.

Jendroř and Kardoř [8] found a necessary and sufficient condition for the existence of $\mathcal{O}_h(5, n)$ -fullerooids, where \mathcal{O}_h denotes the full symmetry group of a regular octahedron. Kardoř [10] characterized $\Gamma(5, n)$ -fullerooids, where Γ is the group of all symmetries of a regular tetrahedron \mathcal{T}_d , or the group of rotational symmetries of a regular tetrahedron \mathcal{T} , or the group \mathcal{T}_h , which is a subgroup of the group \mathcal{O}_h with four 3-fold rotational symmetry axes, three 2-fold rotational symmetry axes, and a point of inversion.

In this paper we solve the question of the existence of fullerooids with a symmetry group of dihedral type. In particular, we investigate fullerooids with the symmetry group \mathcal{D}_m , \mathcal{D}_{md} , and \mathcal{D}_{mh} , where $m \geq 2$.

The symmetry groups \mathcal{D}_m , \mathcal{D}_{md} and \mathcal{D}_{mh} have one specific property among all possible symmetry groups of convex polyhedra: all rotational symmetry axes with the exception of one axis lie in one plane (called main, horizontal plane) and the only other axis (called main, vertical axis) is perpendicular to this plane.

The group \mathcal{D}_m is the group of all rotational symmetries of a regular m -sided prism. It is isomorphic to the triangle group $T(2, m) = \langle x, y : x^2 = y^m = (xy)^2 = 1 \rangle$. The group \mathcal{D}_{md} is the full symmetry group of a regular m -sided antiprism. It is isomorphic to the triangle group $T(2, 2m)$, where the generator of order $2m$ is the rotation-reflection. The group \mathcal{D}_{mh} is the full symmetry group of a regular m -sided prism. It is isomorphic to the full triangle group $\langle x, y, z : x^2 = y^2 = z^2 = 1, (xy)^m = (xz)^2 = (yz)^2 = 1 \rangle$.

The group \mathcal{D}_m is a subgroup of index 2 of both \mathcal{D}_{md} and \mathcal{D}_{mh} . There is another subgroup of index 2 in the group \mathcal{D}_{md} . It is denoted by \mathcal{S}_{2m} and it is generated by the rotation-reflection. The relations among these four symmetry types can be easily observed in Figure 1, where examples of polyhedra with the symmetry groups \mathcal{D}_{7h} , \mathcal{D}_{7d} , \mathcal{D}_7 , and \mathcal{S}_{14} are depicted.

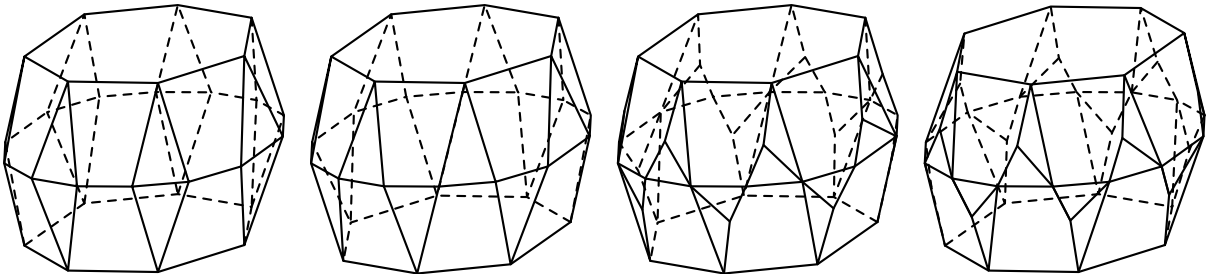

Fig. 1. Examples of polyhedra with \mathcal{D}_{7h} , \mathcal{D}_{7d} , \mathcal{D}_7 , and \mathcal{S}_{14} symmetry, respectively.

The well-known Steinitz Theorem states that a connected graph G is the graph of a convex polyhedron if and only if it is planar and 3-connected. Thus, in some cases it is useful to study 3-connected planar graphs instead of convex polyhedra and not to distinguish between a convex polyhedron and the corresponding graph. Furthermore, by the theorem of Mani [11] (see also [12]), for each such graph G there is a convex polyhedron P such that the graph of P is isomorphic to G and the symmetry group of P is isomorphic to the automorphism group of G . Therefore, to give an example of a $\Gamma(5, n)$ -fullerooid (Γ is either \mathcal{D}_m , \mathcal{D}_{md} , or \mathcal{D}_{mh}), it is sufficient to find a 3-connected cubic planar graph with pentagonal and n -gonal faces whose automorphism group is isomorphic to Γ . Usually, we draw the graph on the surface of regular prism or bipyramid.

2. Operations used to generate examples

To prove that for some number n and for some group Γ (\mathcal{D}_m , \mathcal{D}_{md} , or \mathcal{D}_{mh}) the set of all $\Gamma(5, n)$ -fulleroids is infinite, it is sufficient to find an infinite series of corresponding graphs. This can be done by finding one example and a method of creating a new example from the old.

If the size n of some faces should be increased, two operations are used. If two n -gons are connected by an edge, by inserting 10 pentagons they are changed to $(n+5)$ -gons (see Figure 2). This step can be carried out arbitrarily many times, so the size of these two faces can be increased by any multiple of 5. When this operation is used later in the paper, it is represented by a rectangle with a number inscribed which denotes the number of edges added to the two adjacent n -gons (see e.g. Figure 8), or alternatively its application is indicated only by thickening the edges (see e.g. Figure 11).



Fig. 2. The step to increase the size of two n -gons by 5.

If two m -gons (pentagons or n -gons) are separated by two faces in a position as in the left-hand side picture in Figure 3, the sizes of those faces can be increased equally and arbitrarily (see the right-hand side picture in Figure 3).

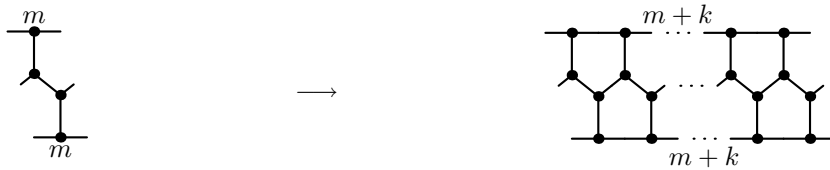

Fig. 3. The step to increase the size of two m -gons arbitrarily.

As a special case of the second operation we get the following: If the two original (m -gonal) faces are pentagons, we can change them into two n -gons and $2n - 8$ new pentagons, so the number of n -gonal faces can be increased by two. For $n \geq 8$ this step can be repeated as many times as required, because two pentagons in an appropriate position can be found among the new pentagons again. The new configuration can always be chosen in such a way that possible local symmetry (rotation through 180°) is not destroyed. In the figures used in this paper, the two pentagons that can be used this way to create infinitely many examples, are shaded and the path of three edges connecting them is doubled. If the operation from Figure 3 has already been used, the pair of pentagons is not emphasized.

For $n = 7$ we need two additional pentagons if the operation is to be carried out again, see Figure 4. If this operation is used, the configuration of four starting pentagons is shaded.

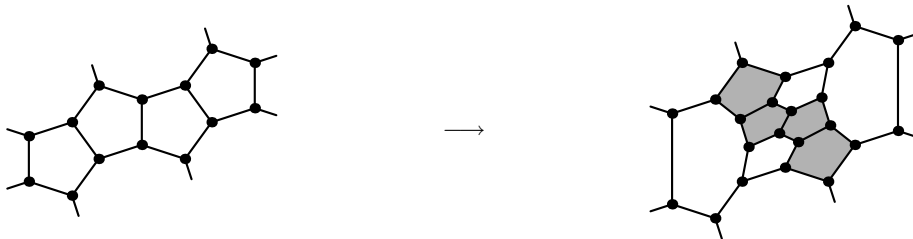

Fig. 4. The step to create two new heptagons.

3. $\mathcal{D}_m(5, n)$ -fulleroids

For this type of symmetry there are no obstructions that could make the existence of particular structures impossible.

Theorem 1 For any $n \geq 6$ the sets $\mathcal{D}_2(5, n)$, $\mathcal{D}_3(5, n)$, and $\mathcal{D}_5(5, n)$ contain infinitely many elements.

Proof. In Figure 5 the graph of a fulleroid with symmetry group \mathcal{D}_2 is shown. It has four n -gonal faces and $4(n - 3)$ pentagonal faces. Two edges marked with an asterisk should be identified to make an embedding of the graph into the sphere.

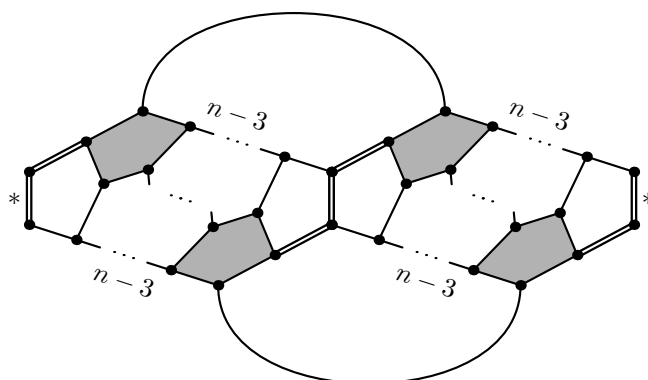

Fig. 5. The graph of a $\mathcal{D}_2(5, n)$ -fulleroid.

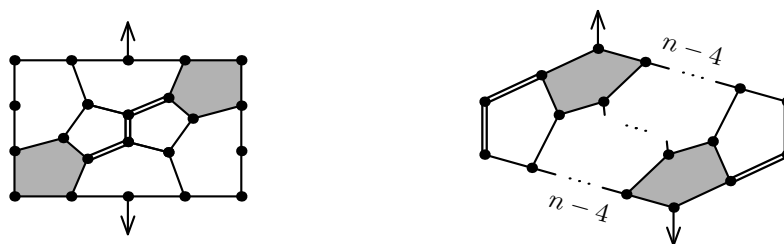

Fig. 6. A segment of the graph of a $\mathcal{D}_3(5, n)$ -fulleroid for $n = 6$ and $n \geq 7$.

If the graph in the left-hand side picture in Figure 6 is inscribed in all three side faces of a regular 3-sided prism and arrowed semiedges are elongated to the vertices in the center of the bases of the prism, the graph of a $\mathcal{D}_3(5, 6)$ -fulleroid is obtained. Analogously, if we use the graph in the right-hand side picture in Figure 6, we get examples of $\mathcal{D}_3(5, n)$ -fulleroids for all numbers $n \geq 7$ with six n -gonal and $6(n - 4)$ pentagonal faces.

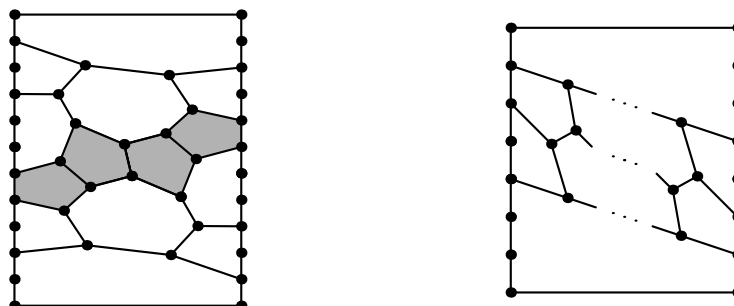

Fig. 7. A segment of the graph of a $\mathcal{D}_5(5, n)$ -fulleroid for $n = 7$ and $n \geq 8$.

If the graph in the left-hand side picture in Figure 7 is inscribed in all five side faces of a regular 5-sided prism, the graph of a $\mathcal{D}_5(5, 7)$ -fulleroid with 42 pentagonal and 30 heptagonal faces is obtained. Similarly, if we use the graph in the right-hand side picture in Figure 7, we get examples of $\mathcal{D}_5(5, n)$ -fulleroids for all numbers $n \geq 8$ with 10 n -gonal and $10(n - 5)$ pentagonal faces. For $n = 6$, all $\mathcal{D}_5(5, 6)$ -fulleroids are in fact fullerenes with \mathcal{D}_5 symmetry. They are classified in [7]. \square

Theorem 2 *Let $m = 4$ or $m \geq 6$ and $n \geq 6$ be integers. If n is not a multiple of m , then the set $\mathcal{D}_m(5, n)$ is empty. If n is a multiple of m , then the set $\mathcal{D}_m(5, n)$ has infinitely many elements.*

Proof. Let P be a convex cubic polyhedron with pentagonal and n -gonal faces only exhibiting \mathcal{D}_m symmetry. Then the main axis of m -fold rotational symmetry intersects P in two points that obviously can be neither vertices nor internal points of edges, since $m > 3$. So the axis intersects P in two faces. Since it is the axis of m -fold rotational symmetry, the faces must have local m -fold rotational symmetry, too. Since $m \neq 5$, the faces cannot be pentagons. Faces that are n -gonal can have m -fold rotational symmetry only if n is a multiple of m .

It is sufficient now to find examples of $\mathcal{D}_m(5, km)$ -fulleroids where $k \geq 1$ is an arbitrary integer. For $k = 1$ and $m = 6$ we get the case of $\mathcal{D}_6(5, 6)$ -fullerenes which are classified in [7]. For $k = 1$ and $m \geq 7$ we can use the graphs shown in Figure 7 and inscribe them in the side faces of a regular m -sided prism. For $k > 1$, appropriate graphs are in Figure 8. \square

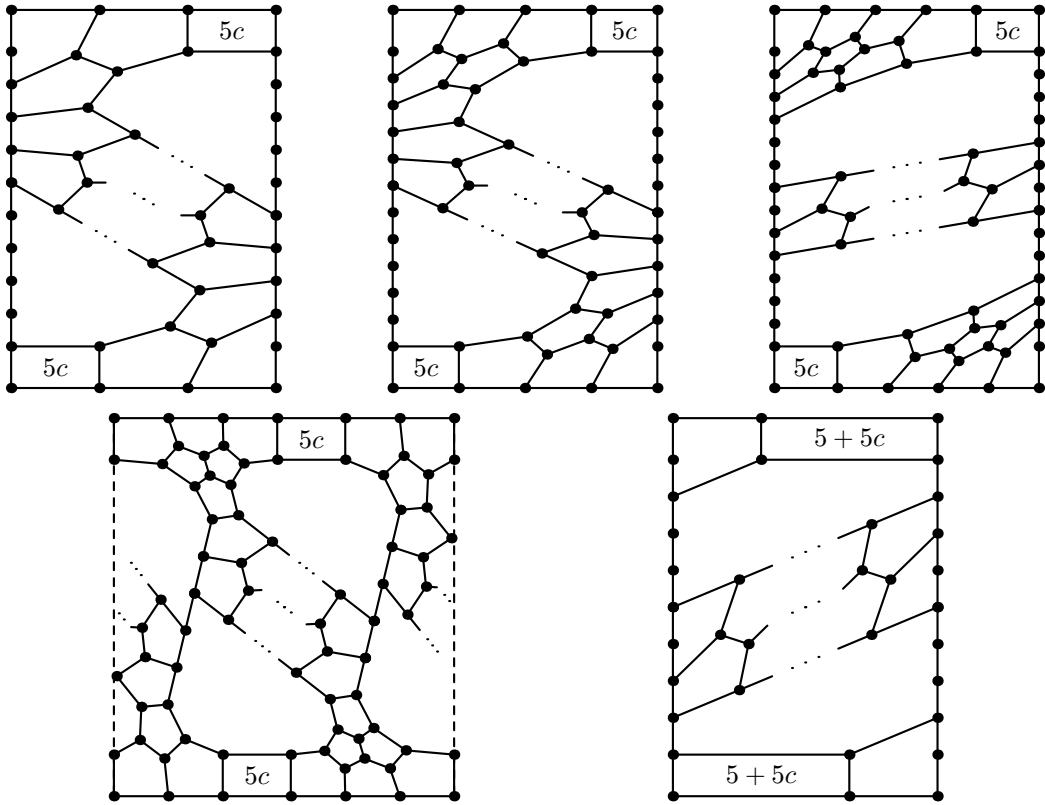

Fig. 8. Examples of graph segments of $\mathcal{D}_m(5, n)$ -fulleroids for $n = (2 + 5c)m$, $n = (3 + 5c)m$, $n = (4 + 5c)m$, $n = (5 + 5c)m$ and $n = (6 + 5c)m$, respectively.

4. $\mathcal{D}_{md}(5, n)$ -fulleroids

Theorem 3 *Let $n \geq 6$ be an integer. If $n \equiv 5 \pmod{10}$, then the set $\mathcal{D}_{2d}(5, n)$ is empty. If $n \not\equiv 5 \pmod{10}$, then the set $\mathcal{D}_{2d}(5, n)$ has infinitely many elements.*

To prove the first claim of this theorem we use the following lemma [8].

Lemma 1 *Let $n \equiv 0 \pmod{5}$ and P be a convex polyhedron with pentagonal and n -gonal faces only and all vertices of degree 3. Then there exists the homomorphism $\Psi : P \rightarrow D$, where D denotes the dodecahedron.*

By homomorphism $\Psi : P \rightarrow D$ we mean the mapping of vertices of the polyhedron P onto those of the polyhedron D , respecting the adjacency structure. Since both P and D are cubic convex polyhedra, it immediately follows that if two edges (faces) of P are adjacent, then also their images are adjacent in D .

Proof of Theorem 3. We prove the first part by contradiction. Let $n = 5 + 10k$ and let P be a $\mathcal{D}_{2d}(5, n)$ -fulleroid. Since all faces of P are of odd size and all vertices of P are trivalent, the main symmetry axis (rotation by 180°) intersects P in two midpoints of edges. The points will be denoted as x and x' , the edges e and e' , respectively. There are two vertical symmetry planes, perpendicular to each other; their intersection is the main axis. The edge e must lie in a vertical symmetry plane. Let this plane be ρ . Since the symmetry is \mathcal{D}_{2d} and not \mathcal{D}_{2h} , the edge e' lies in the other plane, ρ' .

Let $\Psi : P \rightarrow D$ be the mapping given by Lemma 1. Since the size of all faces of P is a multiple of 5, if a point moves from x to x' and back to x along intersection of P and ρ , its image can move only on certain circular lines on D , two of them visible in Figure 9. These lines will be denoted as perimeters of D . Let the perimeter containing $\Psi(P \cap \rho)$ be denoted by p and the perimeter containing $\Psi(P \cap \rho')$ be denoted by p' . Then $\Psi(x) \in p \cap p'$, moreover, p and p' are perpendicular to each other and $\Psi(e) \subset p$. The only possible relative position of p and p' is the position of two perimeters in Figure 9. On the other hand, $\Psi(e') \subset p'$ and $\Psi(x') \in p \cap p'$. This implies that p intersects p' in the midpoint $\Psi(x')$ of the edge $\Psi(e')$, which is impossible.

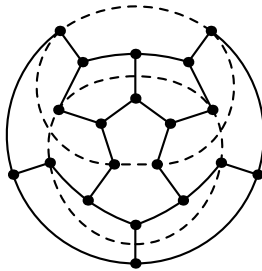

Fig. 9. Two perimeters of the dodecahedron.

To prove the second part it is sufficient to find examples of $\mathcal{D}_{2d}(5, n)$ -fulleroids for all other values of the number n . Unlike the case of $\mathcal{D}_2(5, n)$ -fulleroids, because of the nonexistence of $\mathcal{D}_{2d}(5, 5 + 10k)$ -fulleroids it is impossible to find a universal example where increasing the size of n -gonal faces by any number would be possible.

In Figure 10 we show examples of $\mathcal{D}_{2d}(5, n)$ -fulleroids for $n = 6$ and $n = 7$. In Figure 11 we show graph segments of $\mathcal{D}_{2d}(5, n)$ -fulleroids for $n = 7, 8 + 5k, 9 + 5k, 11 + 5k$, and $12 + 5k$. To obtain a fulleroid, the graph should be inscribed in all four side faces of a regular 4-sided prism (alternating the graph itself and its mirror image), and the topmost and bottommost pairs of edges should be identified. To make this process clear, note that the first graph in Figure 11 is a representation of the fulleroid in the right-hand side picture in Figure 10.

If the left (right) graph shown in Figure 12 is inscribed in all four sides of a regular 4-sided prism (again alternating the graph and its mirror image), the graph of a $\mathcal{D}_{2d}(5, n)$ -fulleroid is obtained, where $n = 10 + 20k$ ($n = 20 + 20k$). \square

Theorem 4 *For any $n \geq 6$ the sets $\mathcal{D}_{3d}(5, n)$, and $\mathcal{D}_{5d}(5, n)$ contain infinitely many elements.*

Proof. If the graphs shown in Figure 13 are inscribed in all three side faces of a regular 3-sided prism and arrowed semiedges are elongated to the vertices in the center of both bases of the prism, graphs of $\mathcal{D}_{3d}(5, n)$ -fulleroid for $n = 7, n = 8$ and $n \geq 9$ are obtained. $\mathcal{D}_{3d}(5, 6)$ -fulleroids are in Graver's catalogue [7] divided into 18 infinite series.

If the graphs shown in Figure 14 are inscribed in all five side faces of a regular 5-sided prism, graphs of $\mathcal{D}_{5d}(5, n)$ -fulleroid for $n = 7, 8, 9, 10$ and $n \geq 11$ are obtained. $\mathcal{D}_{5d}(5, 6)$ -fulleroids are in Graver's catalogue [7] divided into 5 infinite series. \square

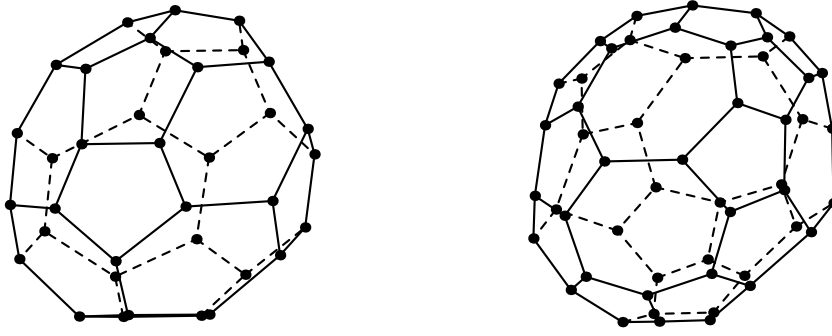

Fig. 10. Examples of $\mathcal{D}_{2d}(5, n)$ -fulleroids for $n = 6$ and $n = 7$.

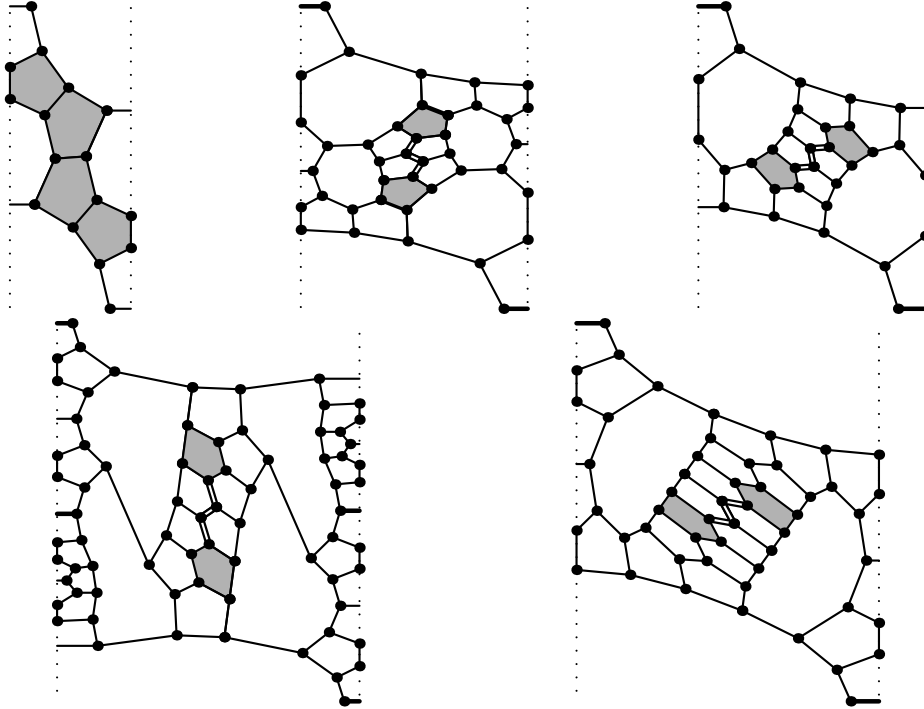

Fig. 11. Graph segments of $\mathcal{D}_{2d}(5, n)$ -fulleroids for $n = 7, 8 + 5k, 9 + 5k, 11 + 5k$, and $12 + 5k$.

Theorem 5 Let $m = 4$ or $m \geq 6$ and $n \geq 6$ be integers. If n is not a multiple of m , then the set $\mathcal{D}_{md}(5, n)$ is empty. If n is a multiple of m , then the set $\mathcal{D}_{md}(5, n)$ has infinitely many elements.

Proof. The first claim is an easy corollary of Theorem 2. If $n = m = 6$, we get the case of \mathcal{D}_{6d} -fullerenes, which are in [7] divided into 7 infinite series. For $n = m \geq 7$, one can inscribe the graphs shown in Figure 14 in all the side faces of a regular m -sided prism to obtain examples of $\mathcal{D}_{md}(5, m)$ -fulleroids. If $n = km$ and $k > 1$, we show only two examples, see Figure 15. For all other cases the constructions are similar. \square

5. $\mathcal{D}_{mh}(5, n)$ -fulleroids

Although the groups \mathcal{D}_{md} and \mathcal{D}_{mh} are of the same order, they behave in a different manner. Even if the number m is odd and the groups are both isomorphic to $T(2, 2m)$, there are some values of numbers n and m such that $\mathcal{D}_{md}(5, n)$ -fulleroids exist and $\mathcal{D}_{mh}(5, n)$ -fulleroids do not.

The group \mathcal{D}_{2h} is not a typical dihedral group, because all three symmetry axes and all three reflection planes are equivalent. It can be seen as a subgroup of the group \mathcal{O}_h , the full symmetry group of the regular

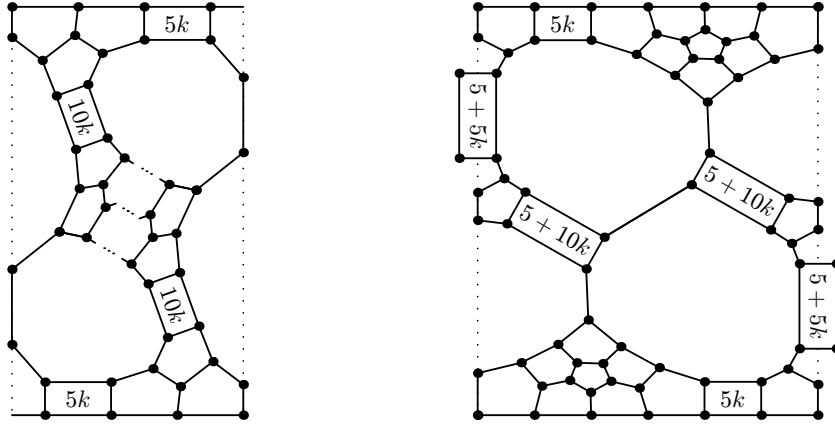

Fig. 12. Graph segments of $\mathcal{D}_{2d}(5, n)$ -fulleroids for $n = 10 + 20k$ and $20 + 20k$.

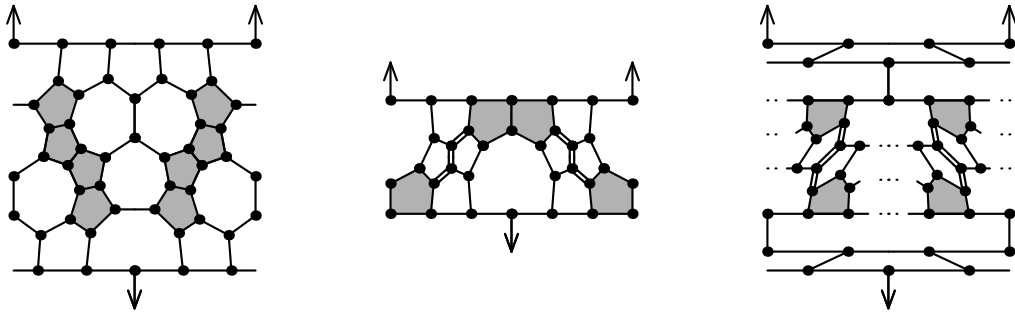

Fig. 13. Graph segments of $\mathcal{D}_{3d}(5, n)$ -fulleroids for $n = 7$, $n = 8$, and $n \geq 9$.

octahedron, in which 3-fold rotation symmetries were destroyed. To depict a \mathcal{D}_{2h} -fulleroid we draw a certain graph onto all eight faces of regular octahedron in such a way that the reflection symmetries are retained.

Theorem 6 For any $n \geq 6$ the set $\mathcal{D}_{2h}(5, n)$ contains infinitely many elements.

Proof. For $n = 6$ we get the case of fullerenes with \mathcal{D}_{2h} symmetry. All \mathcal{D}_{2h} -fullerenes can be divided into 21 infinite series, according to the relative positions of the twelve pentagons. For $n \geq 7$ examples of $\mathcal{D}_{2h}(5, n)$ -fulleroids can be obtained if the graphs shown in Figure 16 are inscribed in all eight faces of a regular octahedron respecting the reflection symmetries. \square

Theorem 7 Let $n \geq 6$ be an integer. If $n \equiv 5$ or $10 \pmod{15}$, then the set $\mathcal{D}_{3h}(5, n)$ is empty. If $n \not\equiv 5, 10 \pmod{15}$, then the set $\mathcal{D}_{3h}(5, n)$ contains infinitely many elements.

Proof. Let $n \equiv 5$ or $10 \pmod{15}$ and P be an $\mathcal{D}_{3h}(5, n)$ -fulleroid. Let the vertical symmetry planes of P be denoted by ρ_1, ρ_2, ρ_3 and the horizontal symmetry plane by ρ_0 . Lemma 1 gives us the homomorphism $\Psi : P \rightarrow D$. If a point moves along the intersection of any of the symmetry planes with P , its image can move only along some perimeter of D . Let p_0, p_1, p_2 and p_3 be perimeters of D such that $\Psi(\rho_i \cap P) \subseteq p_i$; $i = 0, 1, 2, 3$. Since the main vertical 3-fold rotational symmetry axis intersects P in two vertices, p_1, p_2 and p_3 are in relative position like in Figure 17. The point where some ρ_i ($i = 1, 2, 3$) intersects ρ_0 and P can be either an internal point of a face (only if n is even) or a midpoint of an edge. In the first case $p_i = p_0$ and in the second case p_i and p_0 intersect each other in two midpoints of edges of D . If $p_1 = p_0$, then p_0 intersects p_2 and p_3 in vertices of D , which is a contradiction. If p_0 intersects p_1 in two midpoints of edges, it intersects p_2 and p_3 in centers of faces of D (one of two possible relative positions of p_0 is in Figure 17), which is again a contradiction. Thus, for $n \equiv 5$ or $10 \pmod{15}$ the set $\mathcal{D}_{3h}(5, n)$ is empty.

The remaining part of the proof is to show examples of $\mathcal{D}_{3h}(5, n)$ -fulleroids for $n \not\equiv 5$ or $10 \pmod{15}$. For $n = 6$ the fullerenes with \mathcal{D}_{3h} symmetry are in Graver's catalogue [7] divided into 18 infinite series. For $n \geq 7$, $n \not\equiv 0 \pmod{5}$ examples of $\mathcal{D}_{3h}(5, n)$ -fulleroids can be obtained if the graph segments shown in Figure 18 are inscribed in all the faces of a regular bipyramid with a hexagonal base respecting the reflection

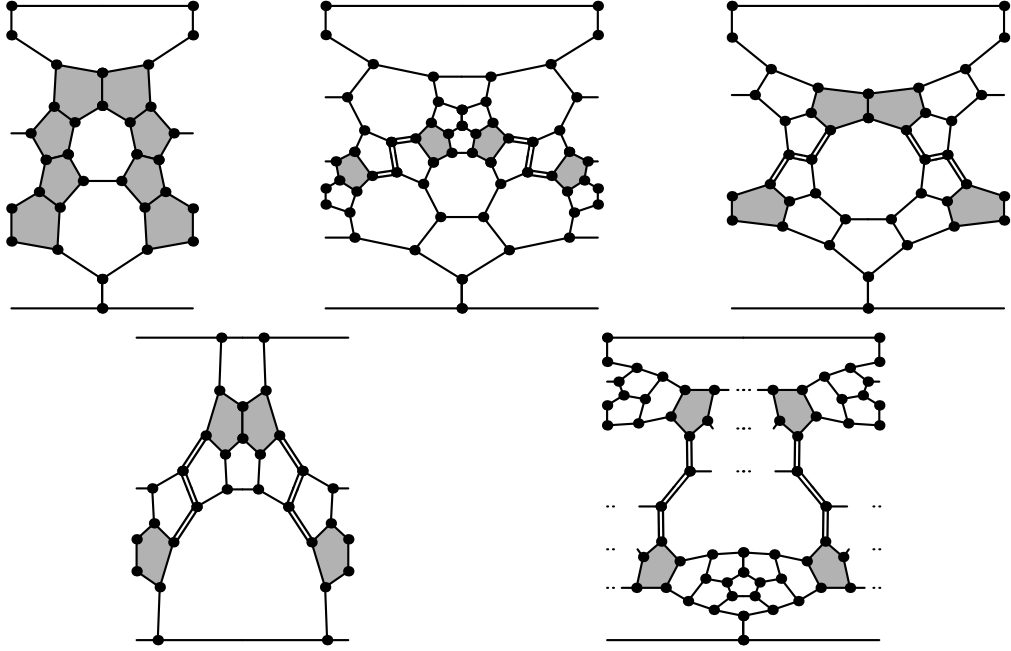

Fig. 14. Graph segments of $\mathcal{D}_{5d}(5, n)$ -fulleroids for $n = 7, 8, 9, 10$ and $n \geq 11$.

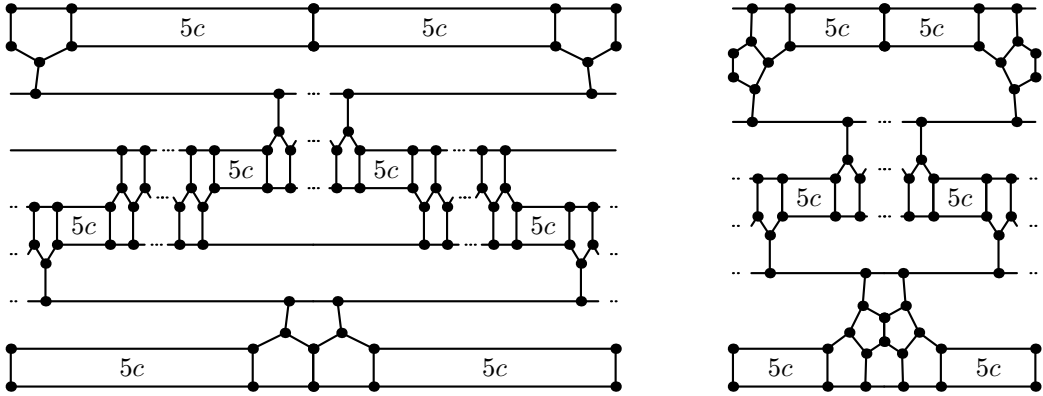

Fig. 15. Graph segments of $\mathcal{D}_{md}(5, n)$ -fulleroids for $n = (2 + 10c)m$ and $n = (3 + 10c)m$.

symmetry in the planes containing the vertices of the bipyramid. For $n = 15 + 30k$ and $n = 30 + 30k$, one can use the graphs segments shown in Figure 19 in a similar way, where $p = 10k$, $q = 5 + 10k$, and $r = 20 + 30k$. \square

Theorem 8 *Let $n \geq 6$ be an integer. If $n \equiv 0 \pmod{5}$ and $n \not\equiv 0 \pmod{25}$, then the set $\mathcal{D}_{5h}(5, n)$ is empty. If $n \not\equiv 0 \pmod{5}$ or $n \equiv 0 \pmod{25}$, then the set $\mathcal{D}_{5h}(5, n)$ contains infinitely many elements.*

Proof. Let $n \equiv 0 \pmod{5}$, $n \not\equiv 0 \pmod{25}$, and P be an $\mathcal{D}_{5h}(5, n)$ -fulleroid. Let the vertical symmetry planes of P be denoted by ρ_1, \dots, ρ_5 and the horizontal symmetry plane by ρ_0 . Lemma 1 gives us the homomorphism $\Psi : P \rightarrow D$. If a point moves along intersection of any of symmetry planes with P , its image can move only along some perimeter of D . Let p_0, p_1, \dots, p_5 be perimeters of D such that $\Psi(\rho_i \cap P) \subseteq p_i$; $i = 0, 1, \dots, 5$. The main symmetry axis intersects P in two faces. These faces can be either pentagons or n -gons. Since $n \not\equiv 0 \pmod{25}$, the perimeters ρ_1, \dots, ρ_5 are pairwise different and intersect each other in a center of a pentagonal face of D .

The point where some ρ_i ($i = 1, \dots, 5$) intersects ρ_0 and P can be either an internal point of a face (only if n is even) or a midpoint of an edge. In the first case $p_i = p_0$ and in the second case p_i and p_0 intersect

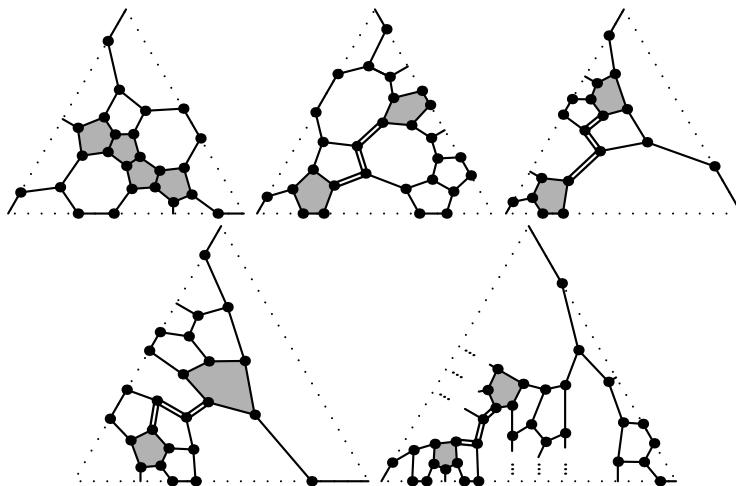

Fig. 16. Graph segments of $\mathcal{D}_{2h}(5, n)$ -fulleroids for $n = 7, 8, 9, 10$ and $n \geq 11$.

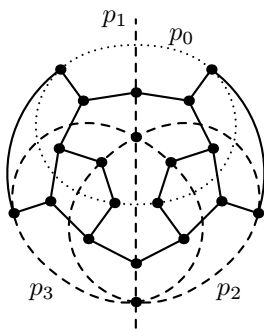

Fig. 17. The perimeters of the dodecahedron.

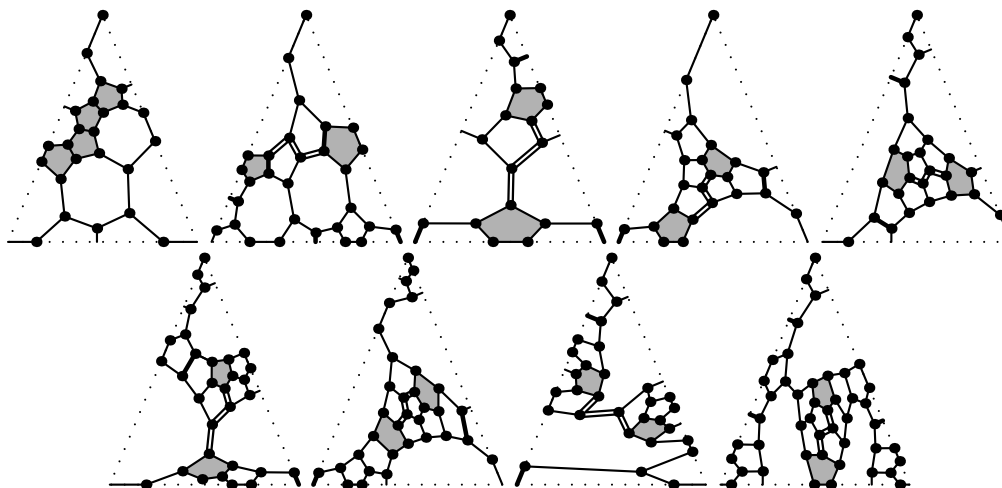

Fig. 18. Graph segments of $\mathcal{D}_{3h}(5, n)$ -fulleroids for $n = 7, 8 + 10k, 9 + 10k, 11 + 10k, 12 + 10k, 13 + 10k, 14 + 10k, 16 + 10k,$ and $17 + 10k$.

each other in two midpoints of edges of D . If $p_i = p_0$ for some i , then $p_0 = p_i$ cannot intersect any other p_j in a midpoint of an edge, thus $p_0 = p_1 = \dots = p_5$, which is a contradiction. But nor can p_0 intersect all p_i in two midpoints of edges.

To complete the proof it is sufficient to show examples of $\mathcal{D}_{5h}(5, n)$ -fulleroids for $n \not\equiv 0 \pmod{5}$ or $n \equiv 0$

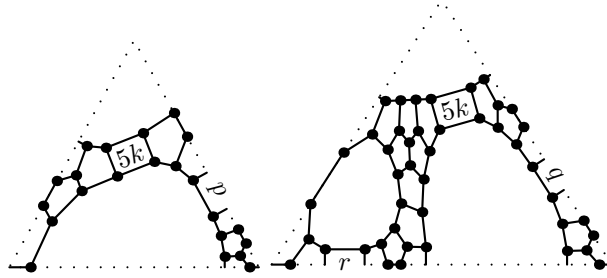

Fig. 19. Graph segments that can be used for construction of examples of $\mathcal{D}_{mh}(5, n)$ -fulleroids for various m and n . See the text for precise values of the parameters $5k$, p , q , and r .

(mod 25). For $n = 6$ the fullerenes with \mathcal{D}_{5h} symmetry are in Graver's catalogue [7], divided into 3 infinite series. For $n \geq 7$, $n \not\equiv 0 \pmod{5}$ examples of $\mathcal{D}_{5h}(5, n)$ -fulleroids can be obtained if the graph segments shown in Figure 20 are inscribed in all the faces of regular bipyramid with decagonal base respecting reflection symmetry in the planes containing the vertices of the bipyramid. For $n = 25 + 50k$ and $n = 50 + 50k$, one can use the graphs segments shown in Figure 19 in a similar way, where $p = 5 + 20k$, $q = 15 + 20k$, and $r = 40 + 50k$. \square

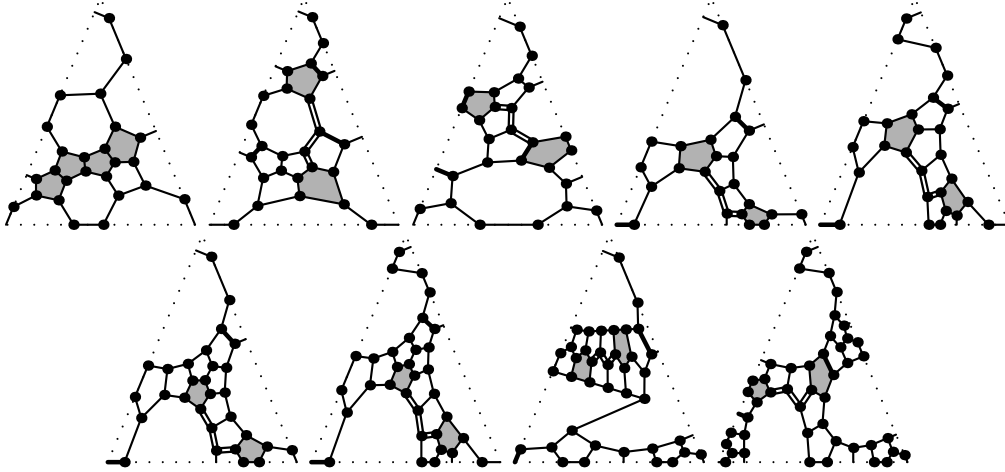

Fig. 20. Graph segments of $\mathcal{D}_{5h}(5, n)$ -fulleroids for $n = 7, 8 + 10k, 9 + 10k, 11 + 10k, 12 + 10k, 13 + 10k, 14 + 10k, 16 + 10k$, and $17 + 10k$.

Theorem 9 *Let $m = 4$ or $m \geq 6$ and $n \geq 6$ be integers and let $m \not\equiv 0 \pmod{5}$. If n is not a multiple of m , then the set $\mathcal{D}_{mh}(5, n)$ is empty. If n is a multiple of m , then the set $\mathcal{D}_{mh}(5, n)$ has infinitely many elements.*

The nonexistence in the first case is an easy corollary of Theorem 2. An example of $\mathcal{D}_{mh}(5, n)$ -fulleroid for $m = 6 + 5k$ and $n = c(6 + 5k)$ can be obtained if the graph shown in Figure 21 is inscribed in all the side faces of regular m -sided prism. For other values of m and n the constructions are similar.

Theorem 10 *Let $m \geq 10$ and $n \geq 6$ be integers and let $m \equiv 0 \pmod{5}$. If n is not a multiple of $5m$, then the set $\mathcal{D}_{md}(5, n)$ is empty. If n is a multiple of $5m$, then the set $\mathcal{D}_{md}(5, n)$ has infinitely many elements.*

The first claim can be proved using the same technique as is the proof of Theorem 8. To prove the second claim, it suffices to find examples of $\mathcal{D}_{mh}(5, n)$ -fulleroids, where $m \equiv 0 \pmod{5}$ and n is a multiple of $5m$. If the graph segments shown in Figure 19 are inscribed in all the faces of a regular bipyramid with the base of size $2m$ respecting reflection symmetry in the planes containing the vertices of the bipyramid, examples of the graphs of $\mathcal{D}_{mh}(5, n)$ -fulleroids are obtained for $n = (5 + 10k)m$ and $n = (10 + 10k)m$, where $2p = n - 15 - 10k$, $2q = n - 20 - 10k$, and $r = n - 10$. \square

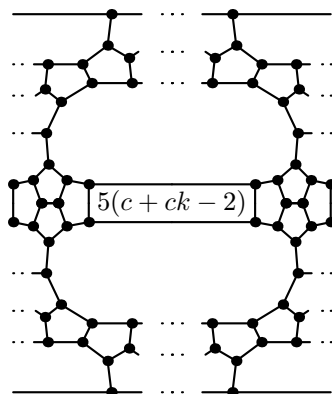

Fig. 21. Graph segment of a $\mathcal{G}_{mh}(5, n)$ -fulleroid for $m = 6 + 5k$, $k \geq 0$, and $m = c(6 + 5k)$, $c \geq 2$.

References

- [1] D. Babić, D.J. Klein, and C.H. Sah, Symmetry of fullerenes, *Chem. Phys. Lett.* 211 (1993) 235–241.
- [2] G. Brinkmann and A.W.M. Dress, Phantasmagorical Fulleroids, *Match* 33 (1996) 87–100.
- [3] P.R. Cromwell, *Polyhedra*, Cambridge University Press, Cambridge, 1997.
- [4] O. Delgado Friedrichs and M. Deza, More Icosahedral Fulleroids, *DIMACS Series in Discrete Mathematics and Theoretical Computer Science*, vol. 51, 2000, pp. 97–115.
- [5] P.W. Fowler, D.E. Manolopoulos, D.B. Redmond, and R.P. Ryan, Possible Symmetries of Fullerene Structures, *Chem. Phys. Lett.* 202 (1993) 371–378.
- [6] P.W. Fowler and D.E. Manolopoulos, *An Atlas of Fullerenes*, Clarendon Press, Oxford, 1995.
- [7] J.E. Graver, Catalog of All Fullerenes with Ten or More Symmetries, *DIMACS Series in Discrete Mathematics and Theoretical Computer Science*, vol. 69, 2005, pp. 167–188.
- [8] S. Jendroľ and F. Kardoš, On octahedral fulleroids, *Discrete Appl. Math.* 155 (26) (2007) 2181–2186.
- [9] S. Jendroľ and M. Trenkler, More icosahedral fulleroids, *J. Math. Chem.* 29 (2001) 235–243.
- [10] F. Kardoš, Tetrahedral Fulleroids, *J. Math. Chem.* 41 (2) (2007) 101–111.
- [11] P. Mani, Automorphismen von polyedrischen Graphen, *Math. Ann.* 192 (1971) 279–303.
- [12] G.M. Ziegler, *Lectures on Polytopes*, Springer, New York, 1994.