



**HAL**  
open science

## Survivorship in potted *Populus deltoides* x *Populus nigra* hybrids in response to gradual soil water depletion

Tete Severien T. S. Barigah, Marie M. Douris, Marc M. Bonhomme, Eric Badel, Régis R. Fichot, Franck F. Brignolas, Hervé H. Cochard

### ► To cite this version:

Tete Severien T. S. Barigah, Marie M. Douris, Marc M. Bonhomme, Eric Badel, Régis R. Fichot, et al.. Survivorship in potted *Populus deltoides* x *Populus nigra* hybrids in response to gradual soil water depletion. Colloque du groupe Xylème, Institut National de la Recherche Agronomique (INRA). FRA., Apr 2011, Nancy, France. 18 diapos. hal-00964541

**HAL Id: hal-00964541**

**<https://hal.science/hal-00964541>**

Submitted on 6 Jun 2020

**HAL** is a multi-disciplinary open access archive for the deposit and dissemination of scientific research documents, whether they are published or not. The documents may come from teaching and research institutions in France or abroad, or from public or private research centers.

L'archive ouverte pluridisciplinaire **HAL**, est destinée au dépôt et à la diffusion de documents scientifiques de niveau recherche, publiés ou non, émanant des établissements d'enseignement et de recherche français ou étrangers, des laboratoires publics ou privés.

# Survivorship in potted *Populus deltoides* *x Populus nigra* hybrids in response to gradual soil water depletion

Barigah TS<sup>1</sup>, Douris M<sup>2</sup>, Bonhomme M<sup>2</sup>, Badel<sup>1</sup>, Fichot R<sup>3,4,5</sup>,  
Brignolas F<sup>3,4</sup>, Cochard H<sup>1</sup>

<sup>1</sup>INRA, UMR547 PIAF, F-63100 Clermont-Ferrand, France

<sup>2</sup>Université Blaise Pascal, UMR547 PIAF, F-63177 Aubière, France

<sup>3</sup>Université d'Orléans, UFR-Faculté des Sciences, UPRES EA 1207 Laboratoire de  
Biologie des Ligneux et des Grandes Cultures (LBLGC), BP 6759, F-45067, France

<sup>4</sup>INRA, USC2030 Arbres et Réponses aux Contraintes Hydrique et  
Environnementales (ARCHE), BP 6759, F-45067, France

<sup>5</sup>INRA UR588 Amélioration, Génétique et Physiologie Forestières (AGPF), Centre  
de Recherche d'Orléans, CS 40001 Ardon, F-45075, Orléans Cedex 2, France.

# Introduction

- ❖ Recent climate projections → increase in frequency and duration of intense summer droughts (Badeau et al., 2005; Salinger et al., 2005; IPCC, 2007).
- ❖ Studies on drought-induced plant mortality and survivorship have rekindled interest in foresters and scientists' communities.
- ❖  $\Psi_{50}$  (a proxy of cavitation resistance) was regarded as a bio-sensing device (gauge) for drought sensitivity detection in trees (Cochard et al. 2005)
- ❖  $\Psi_{50}$  was reported to vary consistently with the reputed habitat of tree species (Hacke et al. 2000; Pockman and Sperry 2000; Brodribb and Cochard 2009)
- ❖ But the effectiveness of  $\Psi_{50}$  as a gauge is not demonstrated yet!

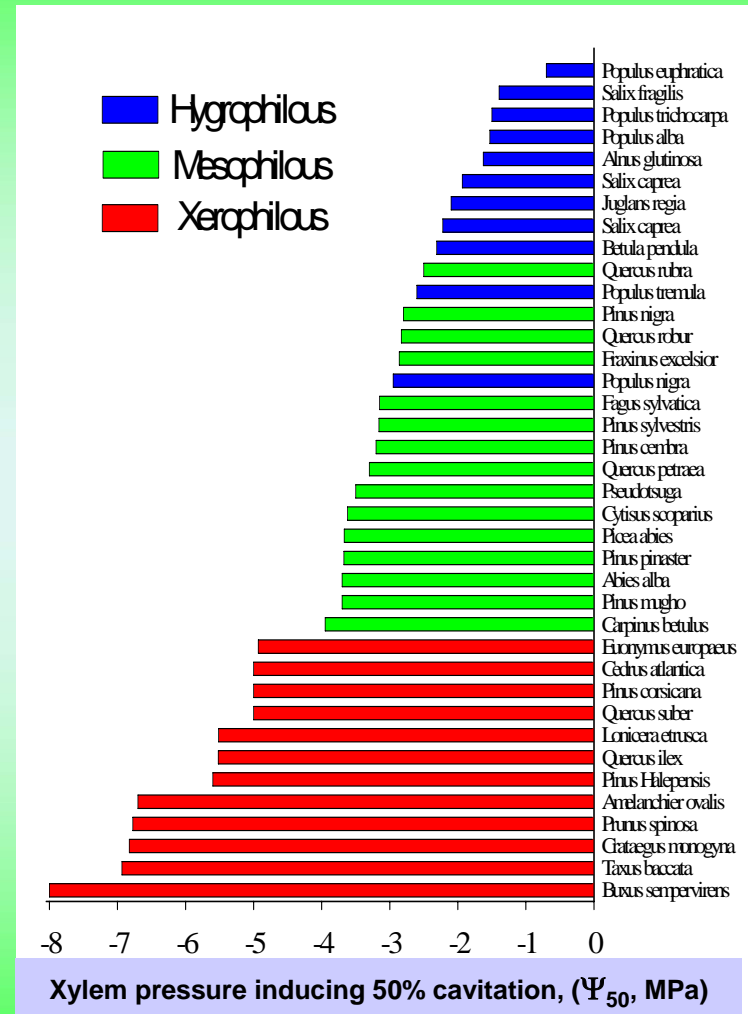

# Objectives

The objectives of this study were to:

- ❖ test and interpret the differences in response to protracted summer drought of the chosen unrelated poplar hybrids mainly **if the hybrid with the lowest  $\Psi_{50}$  was the most resistant to drought-induced cavitation,**
- ❖ link cutting's leaf water potential and their hydraulic features to volumetric soil moisture content,
- ❖ check for whether xylem dysfunction leads to plant mortality.

# Material and methods

*Populus deltoides* Bartr. ex Marsh x *Populus nigra* L.  
unrelated hybrids

- Eco 28 ( $\Psi_{50}=-2.41$  MPa)
- I45-51 ( $\Psi_{50}=-1.69$  MPa)
- Robusta ( $\Psi_{50}=-1.60$  MPa)

(Fichot et al., 2009; Fichot et al., 2010)

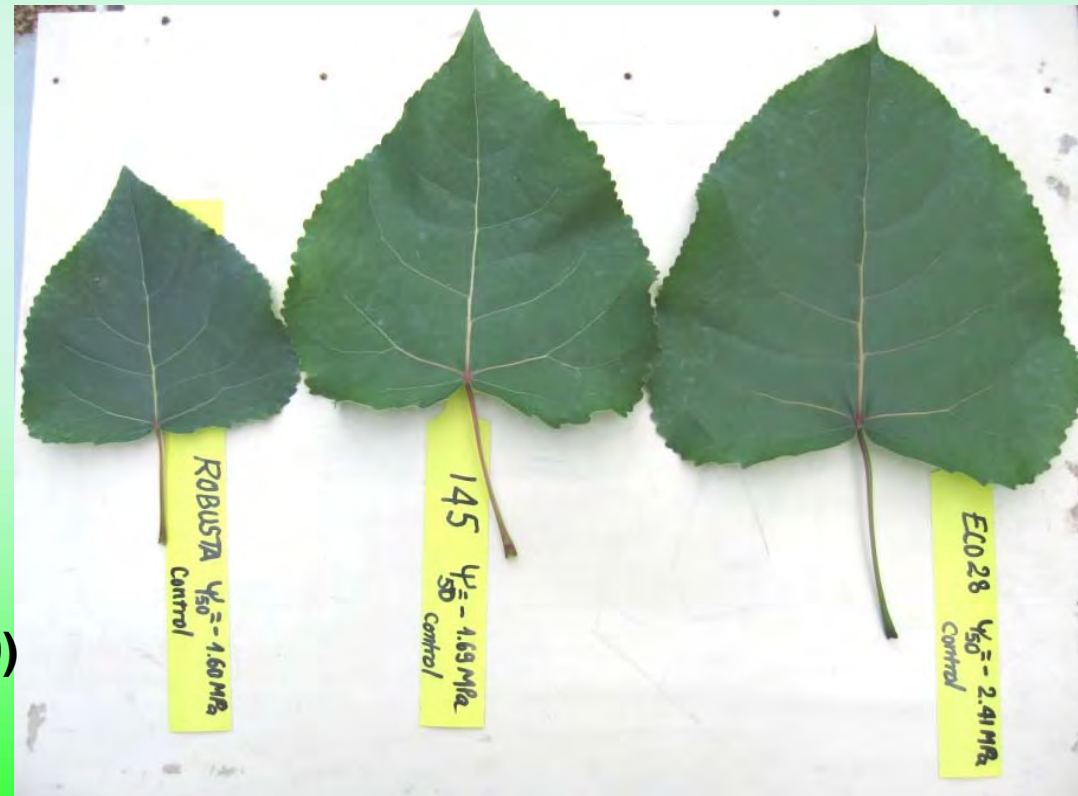

# Growth conditions



- 3x50 current year cuttings of *Populus deltoïdes* x *Populus nigra* hybrids fed in 20-liter pot each
- 3x8 harvested sprouts per week
- Relative radiation: 80% of full sunlight
- Temperature: 15 - 30°C
- Relative humidity: 40-70%
- Daily drip irrigation for control plants and water shortage for the others.

- *Time domain reflectometer*  
(Soil moisture content)



- *Pressure chamber*  
(Leaf and xylem water potential)



- *Xylem Embolism Meter*  
(Xylem native steady-state embolism)



- *Cavitron*  
(Water potential inducing 50 % loss of conductance)

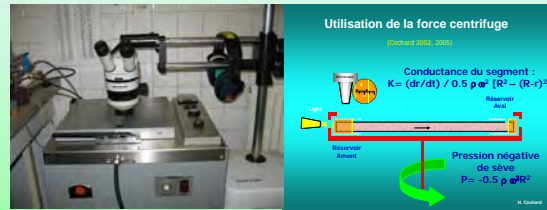

- *Microcalorimeter*  
(Bud respiration rates)



# Results



- It comes as an evidence that water shortage inhibits growth in plant size
- Growth in height tended to be the lowest in I45-51 but the highest in diameter for control plants while for drought-treated plants, Robusta tended to display the highest growth in height but did not differ in diameter from others.

**Growth in height for three Poplar hybrids versus dry-down span**

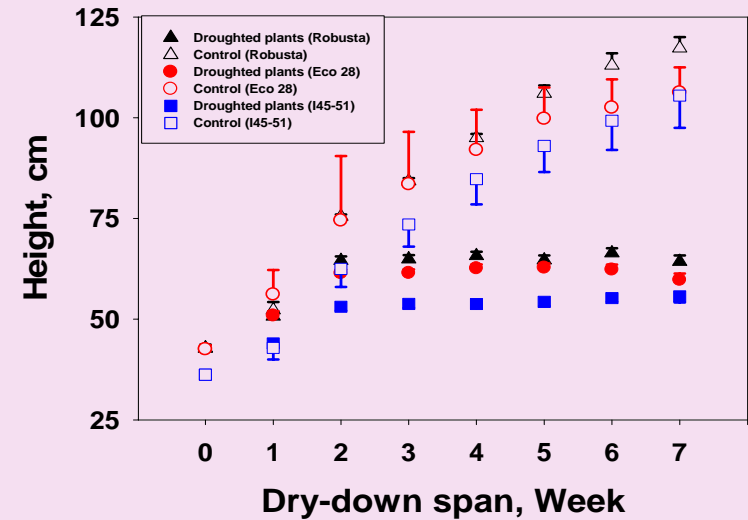

**Growth in diameter for three Poplar hybrids versus dry-down span**

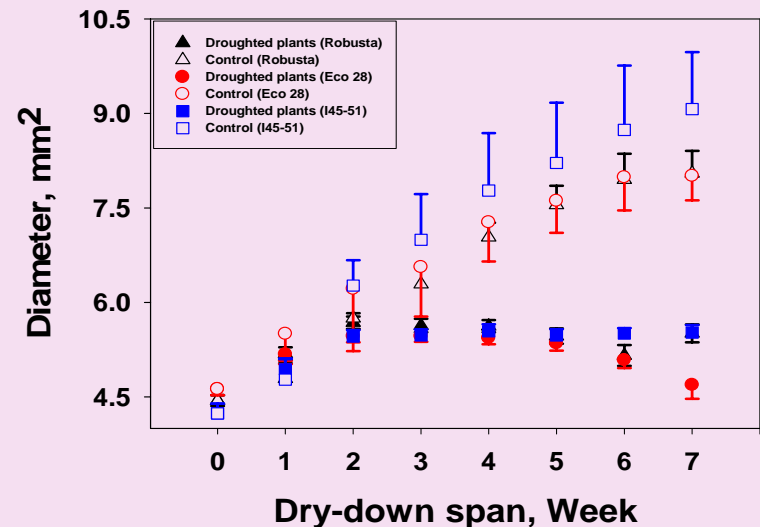

## Dynamic of volumetric soil moisture content within the pots of the Poplar hybrids versus dry-down span

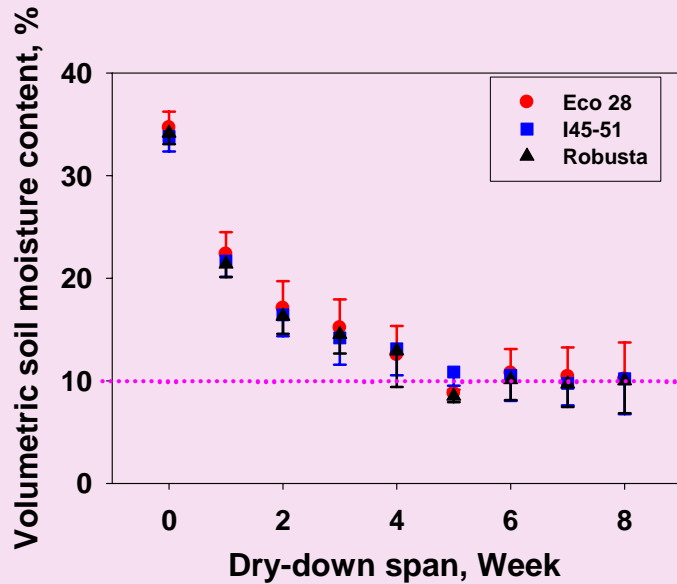

- **Steep drop in volumetric soil moisture content (VSMC): more than 50% loss over 2 weeks**
- **10% of maximum VSMC threshold appeared to be critical.**

## Variation in predawn leaf water potential of Poplar hybrids versus dry-down span

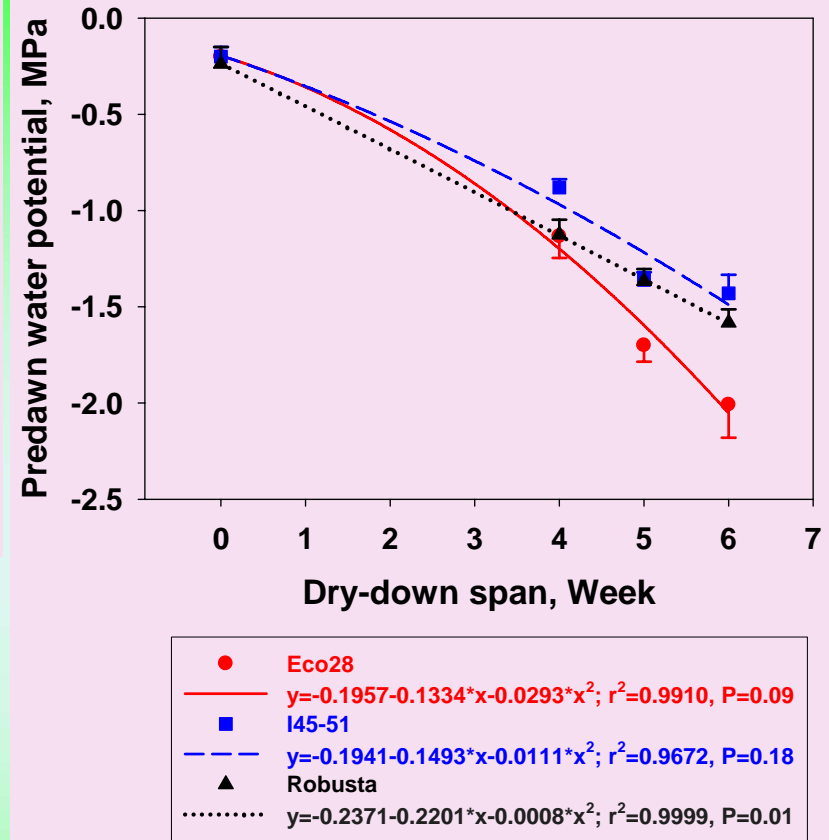

- **Fast drop in  $\Psi_p$  for Eco28 in comparison with the other 2 hybrids.**

Percent loss conductivity (PLC) increased sigmoid-like along with decreasing in volumetric soil moisture content for all three hybrids

Relationships between percent loss conductivity and volumetric soil moisture content versus dry-down span

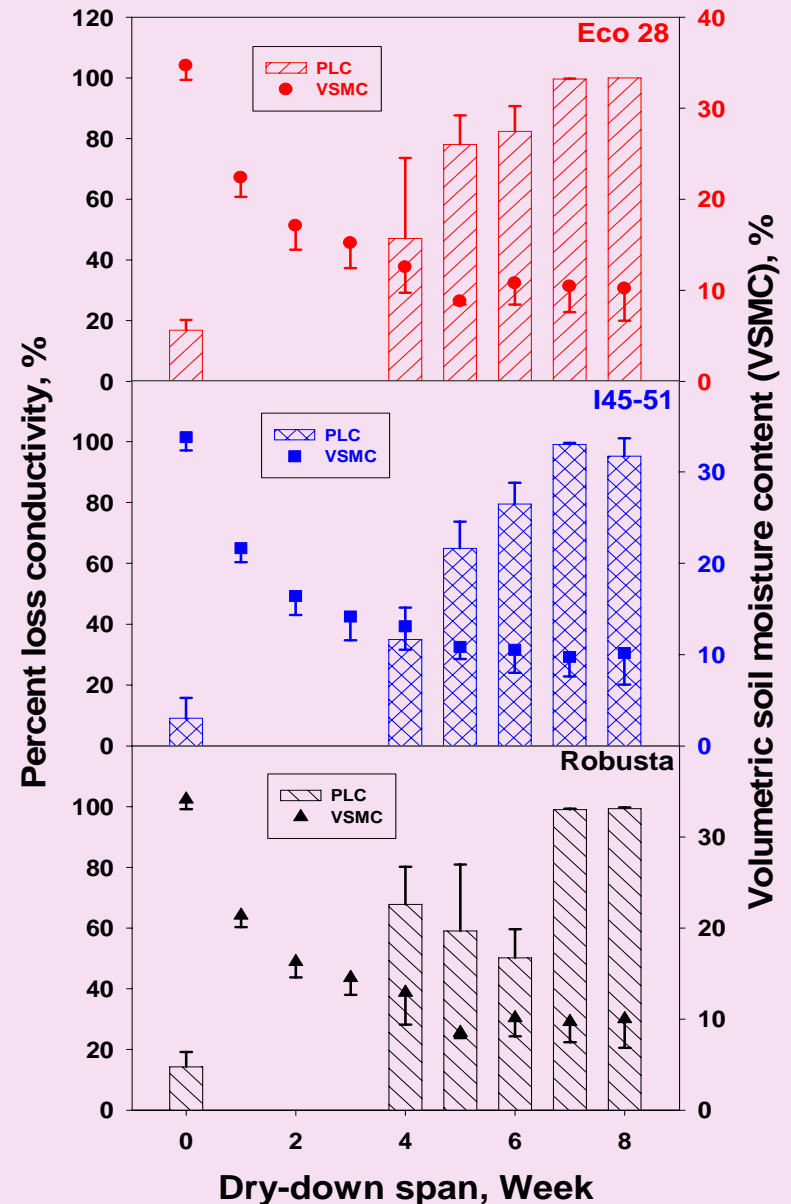

Over time, percent loss conductivity increased while predawn leaf water potential dropped for all 3 hybrids.

Relationships between percent loss conductivity and predawn leaf water potential versus dry-down span

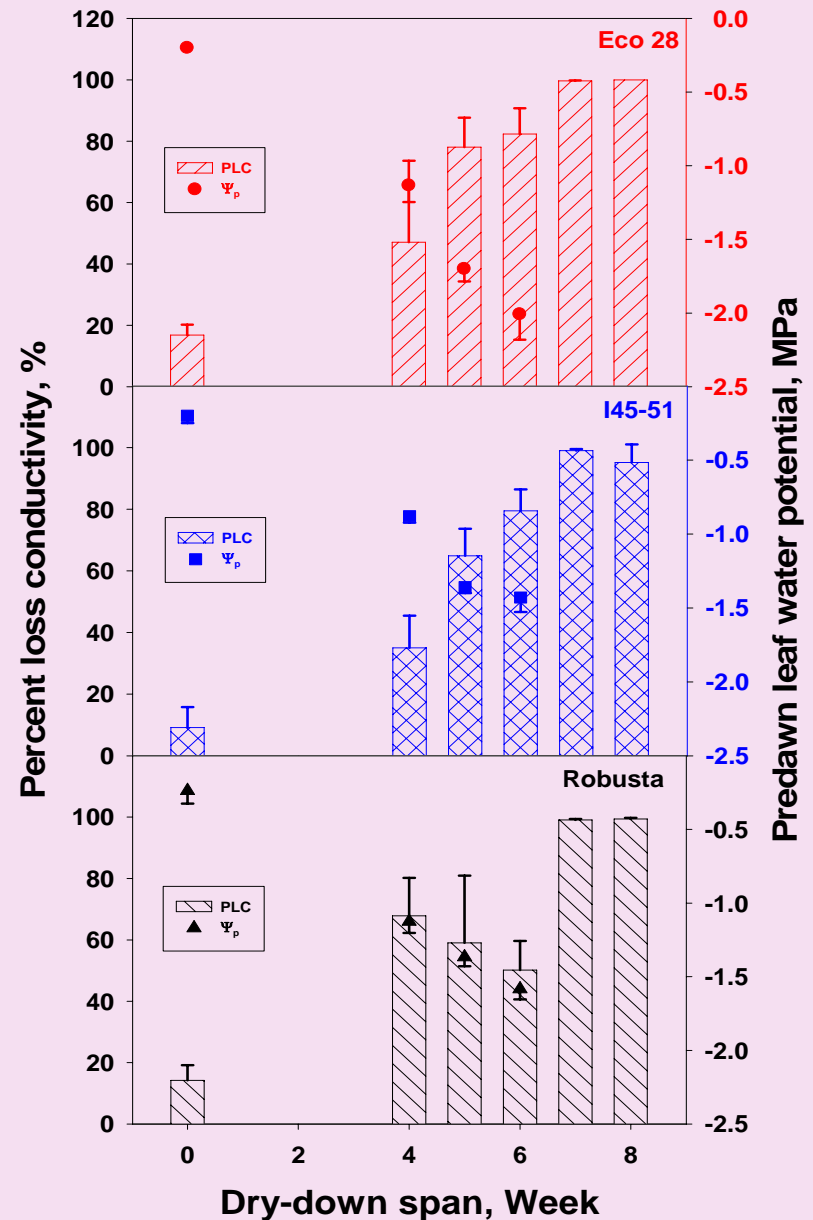

- Since drought inception mortality occurred in 5 weeks in Eco 28 hybrids but 2 weeks later in the 2 others
- None of Eco 28 individuals survived 7 weeks after drought inception roughly when  $\Psi_p$  got below -1.0 MPa
- Therefore, survivorship was threatened the most in Eco 28 hybrids

Relationships between percent loss conductivity and survivorship of Poplar hybrids versus dry-down span

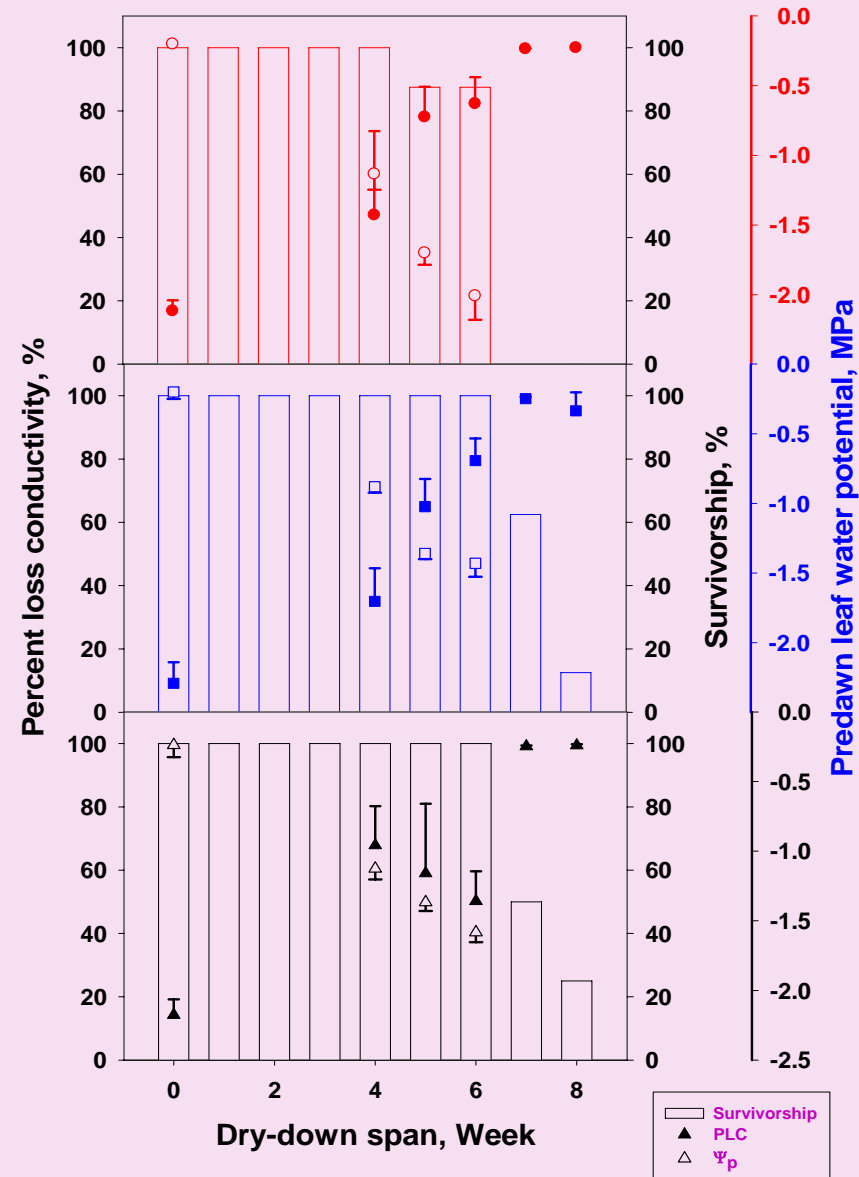

## Bud respiration rate in 3 Poplar hybrids versus dry-down span

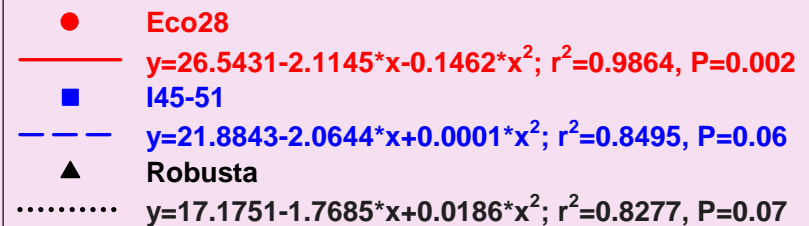
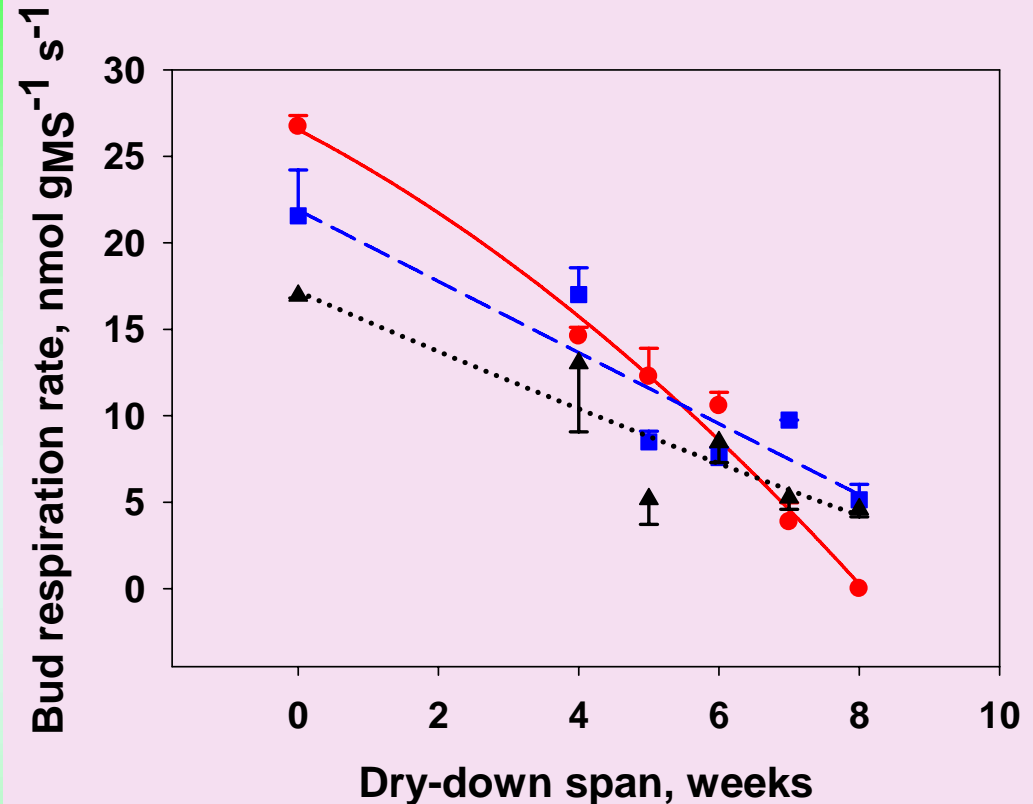

- Bud respiration rate for Eco28 control sprouts was the highest in comparison with others
- The respiration rate dropped to nil only in Eco28 hybrids by week 8.

# Conclusion

Sprouts of Eco28 were the most sensitive to the gradual soil moisture depletion whatever the morphological or the physiological parameter we considered. Therefore, we concluded that using  $\Psi_{50}$  as a gauge to stand for drought resistance in Poplar hybrids does not hold.

However, we still believe that  $\Psi_{50}$  is relevant enough to sort out samples of different species ... regarding the displayed picture.

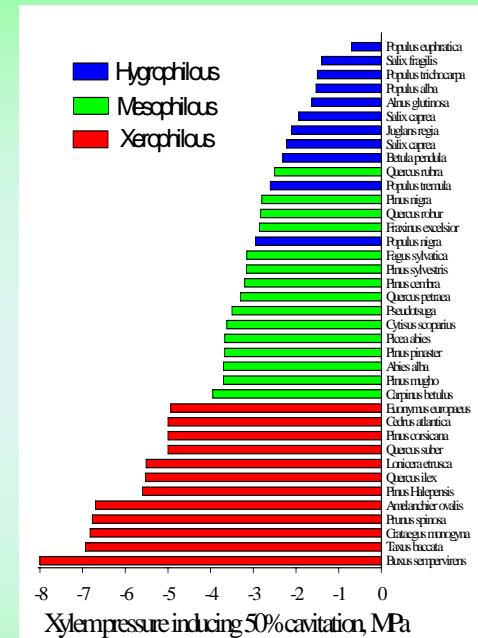

# Perspectives

❖ Check for the consistency of our findings

❖ Look into drought-induced acclimation in hydraulic features of newly produced shoots after the release from water shortage.



**Many thanks for  
your attention**

***and***

**Our acknowledgements to  
C. Bodet, C. Serre, P. Conchon,  
P. Chaleil and A. Faure  
for their field assistance!**

**Delayed-effects of drought spells on newly released sprouts of Robusta plants**

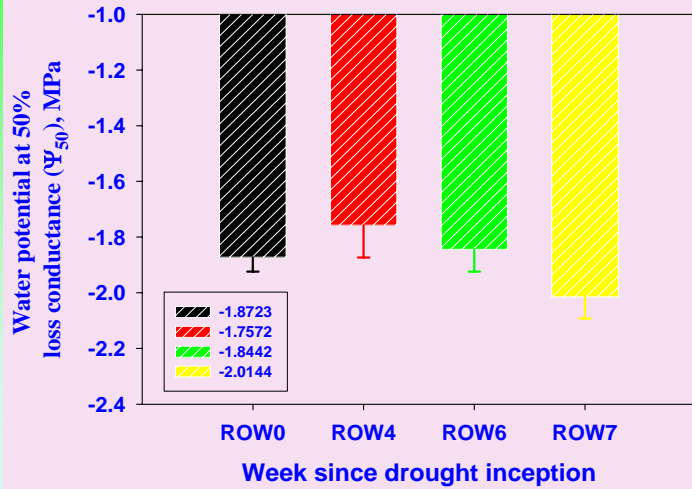

**Delayed-effects of drought spells on newly released sprouts of Eco 28 plants**

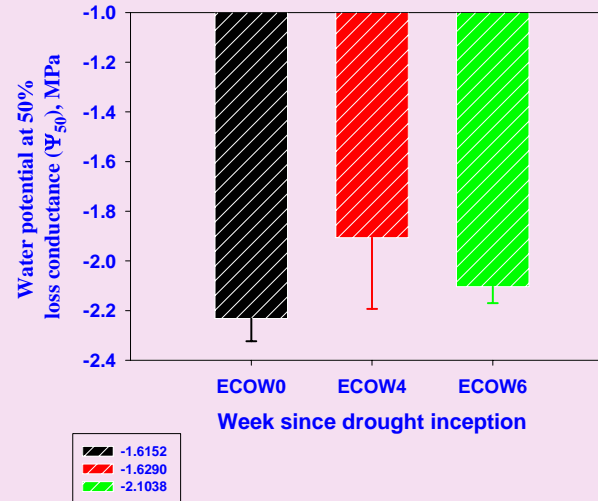

**Delayed-effects of drought spells on newly released sprouts of I45-51 plants**

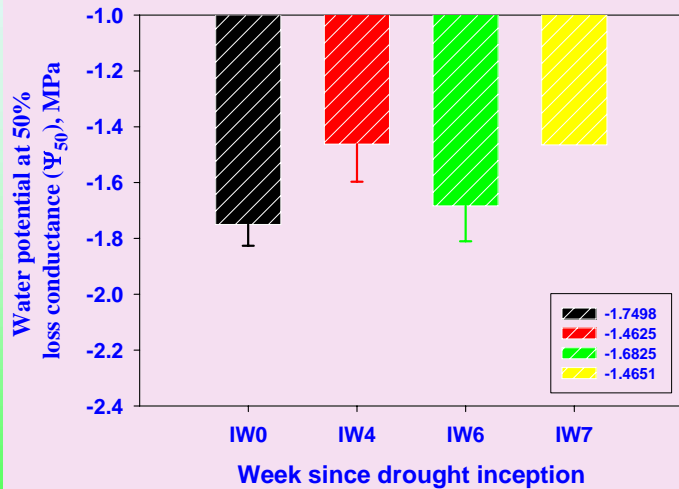

**Eco 28 ( $\Psi_{50}=-2.41$  MPa)**

**I45-51 ( $\Psi_{50}=-1.69$  MPa)**

**Robusta ( $\Psi_{50}=-1.60$  MPa)**

**(Fichot et al., 2009  
Fichot et al., 2010)**

**Water potential at 50% loss conductance ( $\Psi_{50}$ ) of newly released shoots (control) of the 3 poplar hybrids**

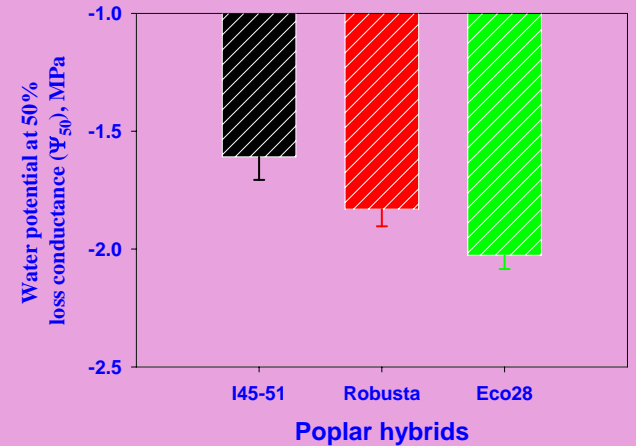

Relationships between bud respiration rate and gravimetric bud water content

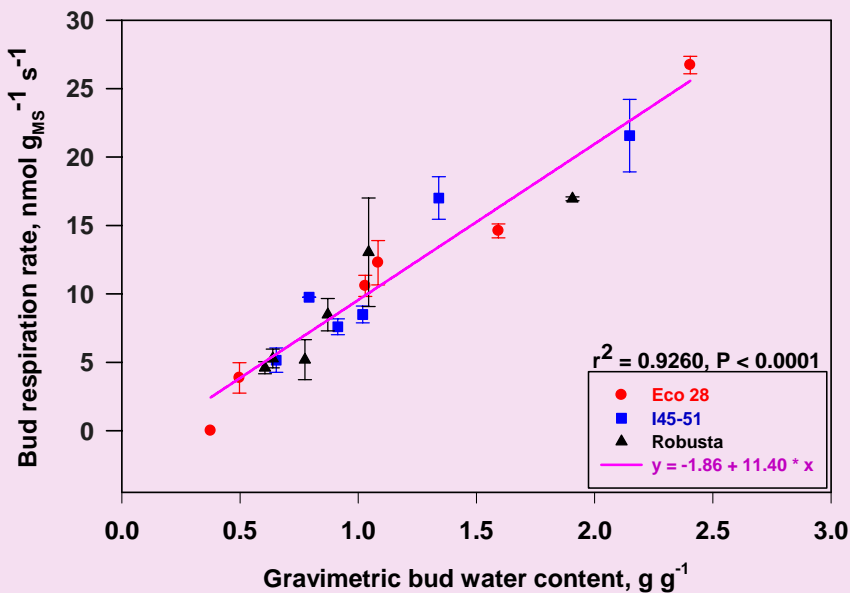

Gravimetric bud water content or bud respiration rates can stand for gauges of plant mortality.

Relationships between bud respiration rate, gravimetric bud water content and survivorship in Poplar hybrids versus dry-down span

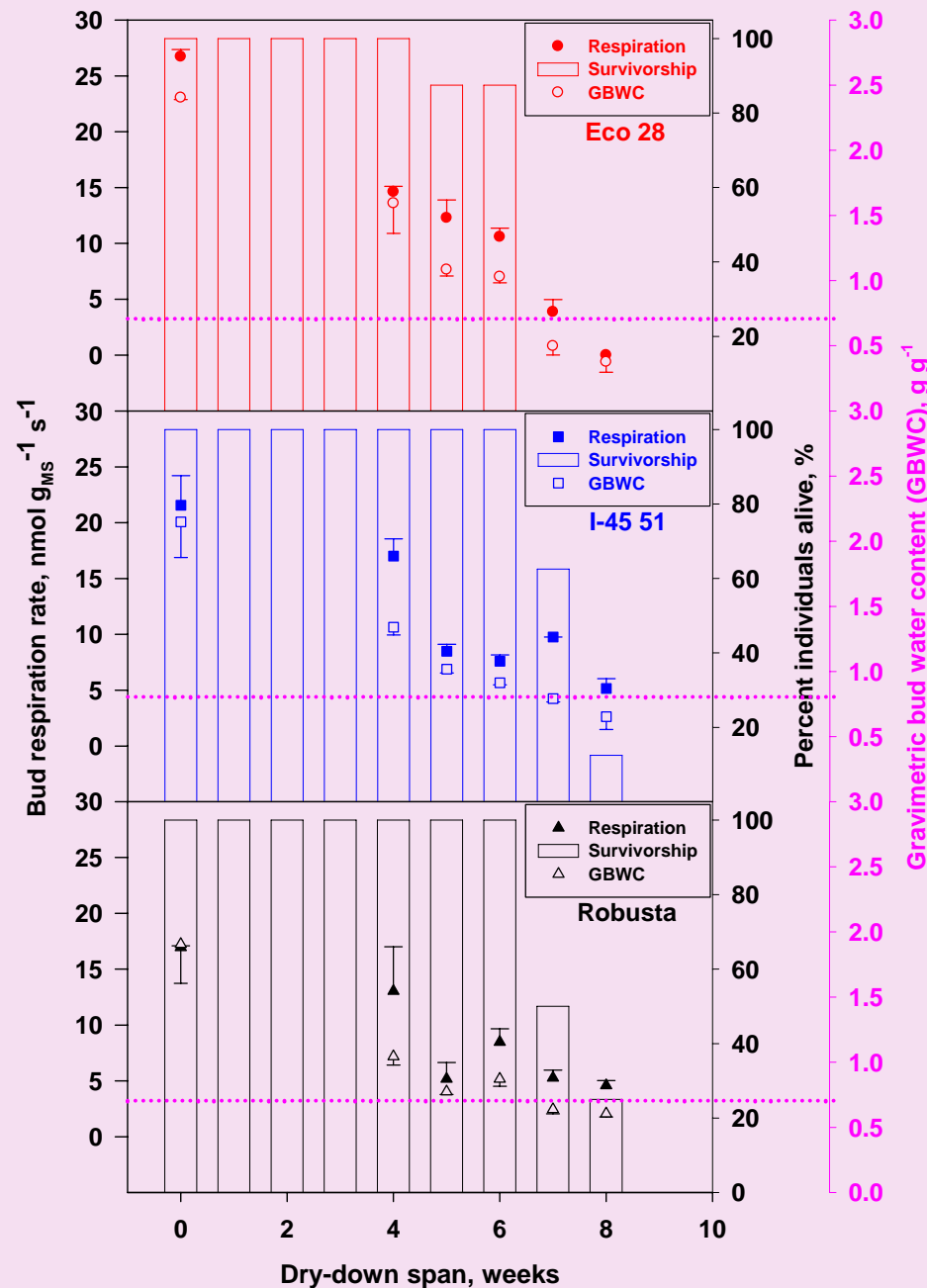

# Aquaporin *TIP1* expression and its regulation in the growing root apex under two levels of osmotic stress

*Rémy Merret, Irène Hummel, Bruno Moulia, David Cohen  
et Marie-Béatrice Bogeat-Triboulot*

*UMR EEF INRA-UHP, Nancy  
UMR PIAF INRA-UBP, Clermont-Ferrand*



# Referential change

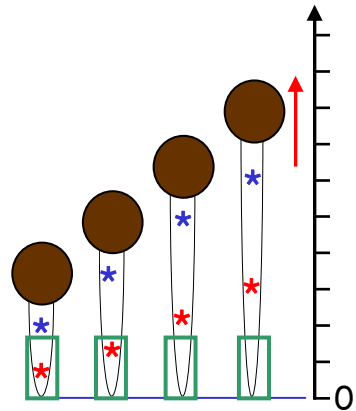
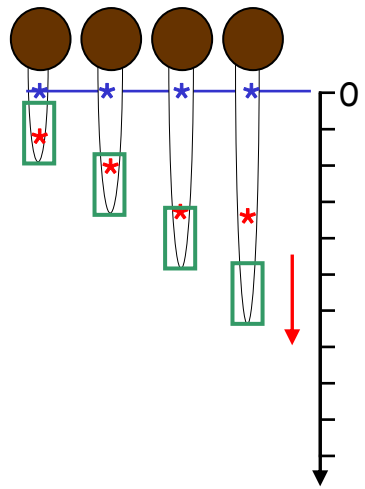
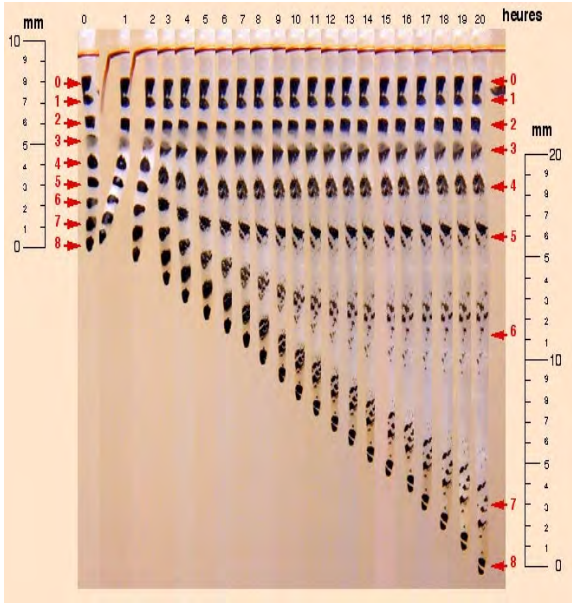

Referential change :

The root apex is a constant structure in which elements are continuously renewed

# Growth = division + cell expansion

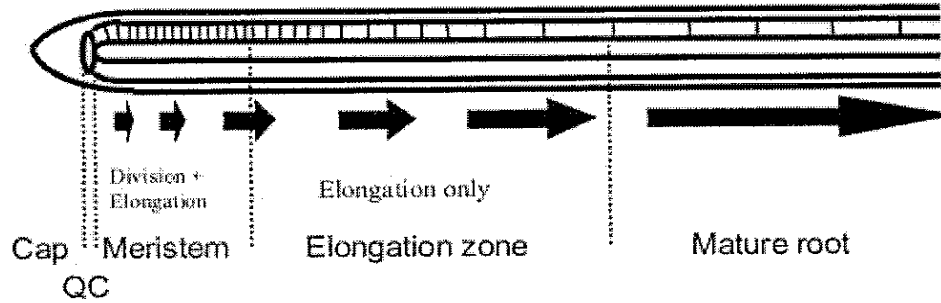

Beemster et al, 2002

$$\text{Growth} = V_{\text{cell production}} \times L_{\text{mature}}$$

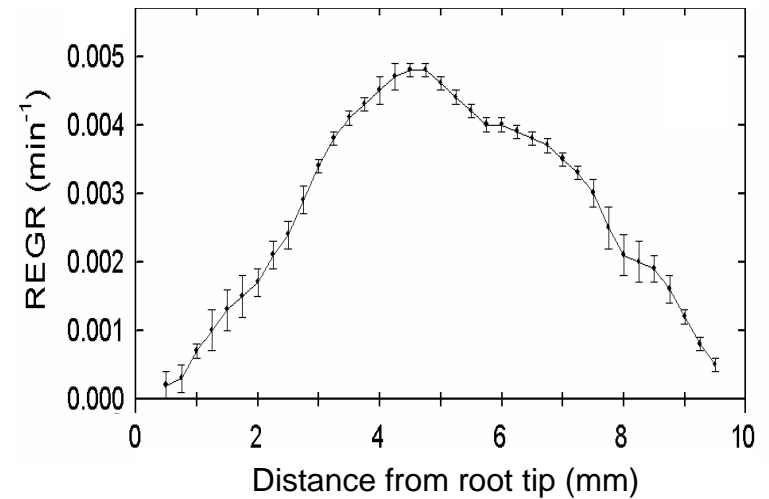
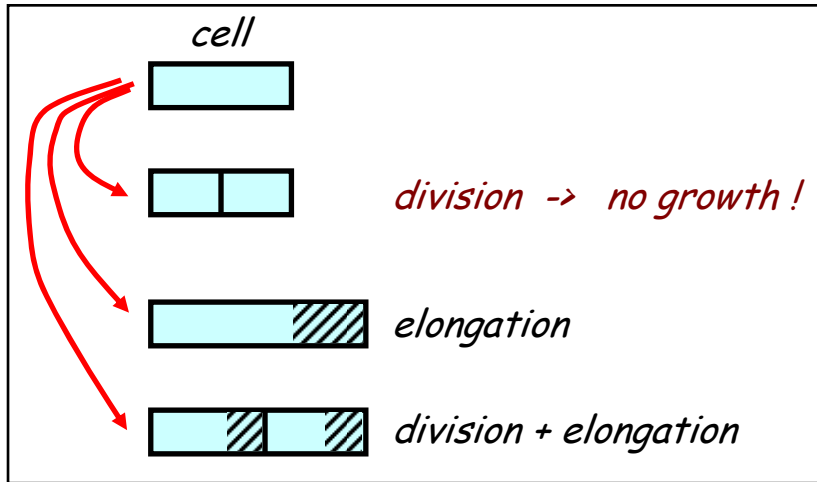

# Control of cell expansion

## Biophysical model of cell expansion (Lockhart, 1965)

- Motor : turgor pressure
- Controls : Cell wall extensibility & membrane hydraulic conductivity ( $L_p$ )

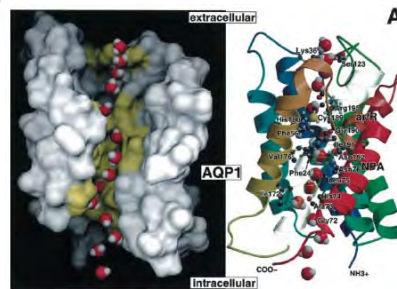
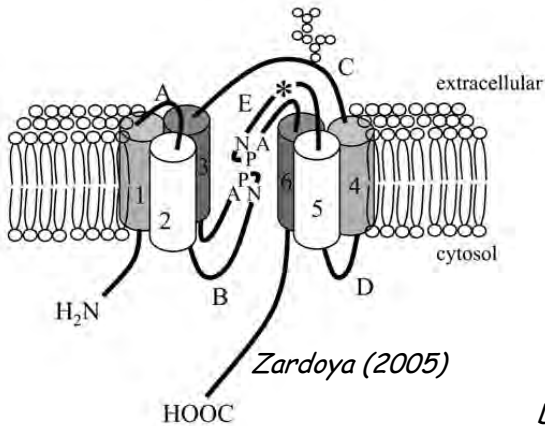
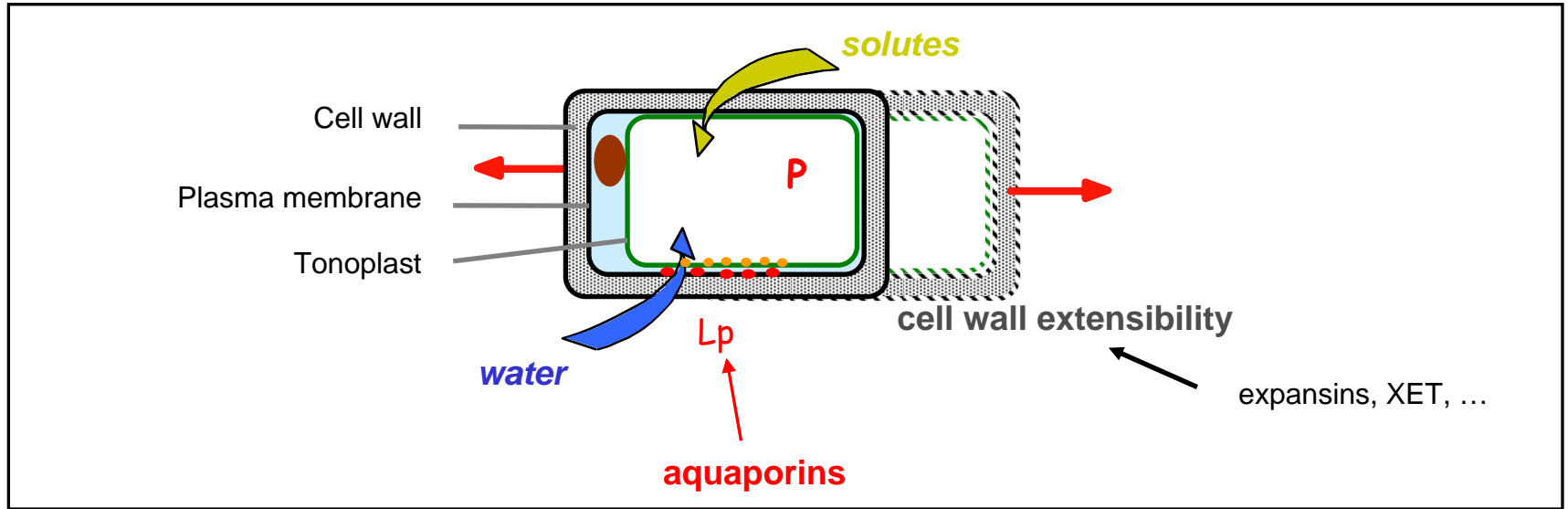

## Aquaporin family : two main classes

- PIP : Plasma membrane intrinsic protein
- TIP : Tonoplast intrinsic protein
- + NIP, SIP, XIP ...

## ↪ Hydraulic limitation of cell expansion ?

- Boyer versus Cosgrove
- estimation from the magnitude of Growth Induced/Sustaining Water Potential Gradient
- about 3-4 bars in leaves and hypocotyls
- never found in roots ...

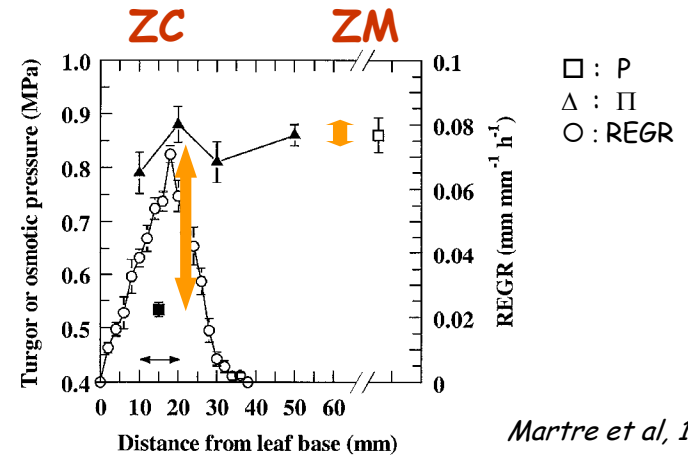

Martre et al, 1999

## ↪ Involvement of Aquaporins ...

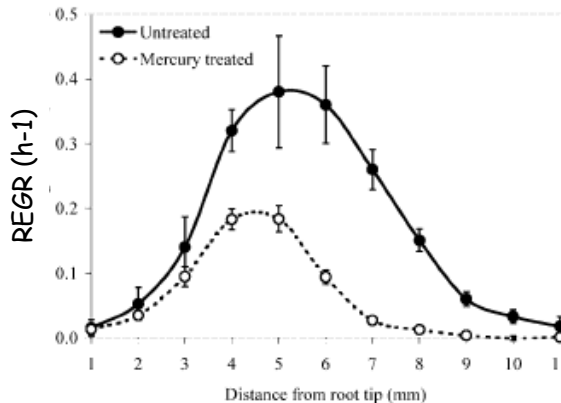

(Hukin et al, 2002)

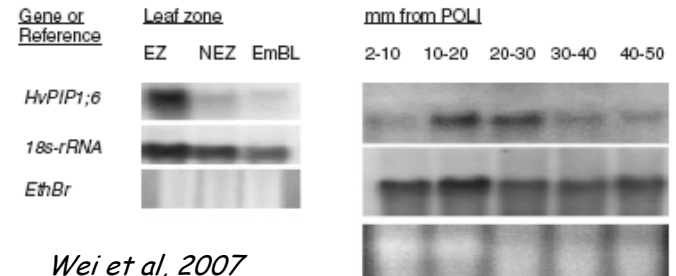

Wei et al, 2007

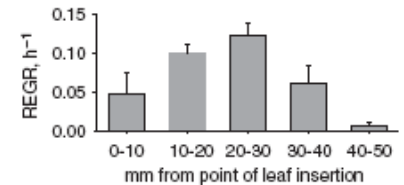



# Context and aims

↪  $Lp_{\text{tonoplast}} \gg Lp_{\text{plasma membrane}}$  but  $Lp_{\text{tonoplast}}$  also important for rapid water balance between cytoplasm and vacuole

↪ Aims of the study :

- Which *TIP1s* are expressed in the Poplar root growth zone?
- How are the expression affected by osmotic stress?
- On the basis of transcript accumulation and their changes, can we detect a link between cell expansion and the expression of some *TIPs*?
- What can we learn from the regulation of *TIPs* expression?

Pt : *Populus trichocarpa*

Os : *Oryza sativa*

At : *Arabidopsis thaliana*

Zm : *Zea mays*

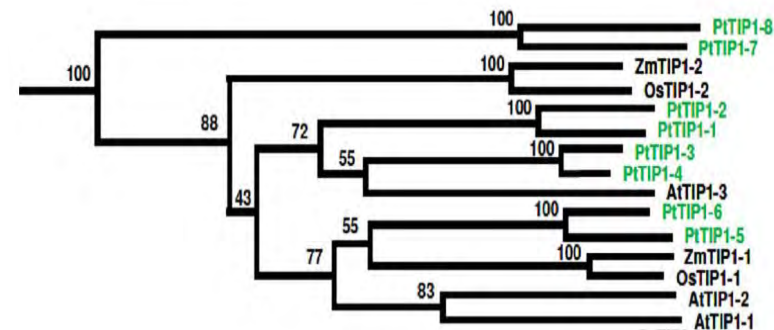

Gupta and Sankaramakrishnan, 2009

8 *TIP1s* in *Populus trichocarpa* genome  
4 paralog pairs (gene duplication)

# Root growth under osmotic stress



- Cuttings of *Populus deltoïdes x nigra* cv Soligo (15 cm)
- Hydroponics : Hoagland  $\frac{1}{2}$  + phosphates
- Controlled environment (21°C, 70 % relative humidity, 16h light regime)



Control  
100g/L PEG (90 mosmol/kg)  
200g/L PEG (260 mosmol/kg)

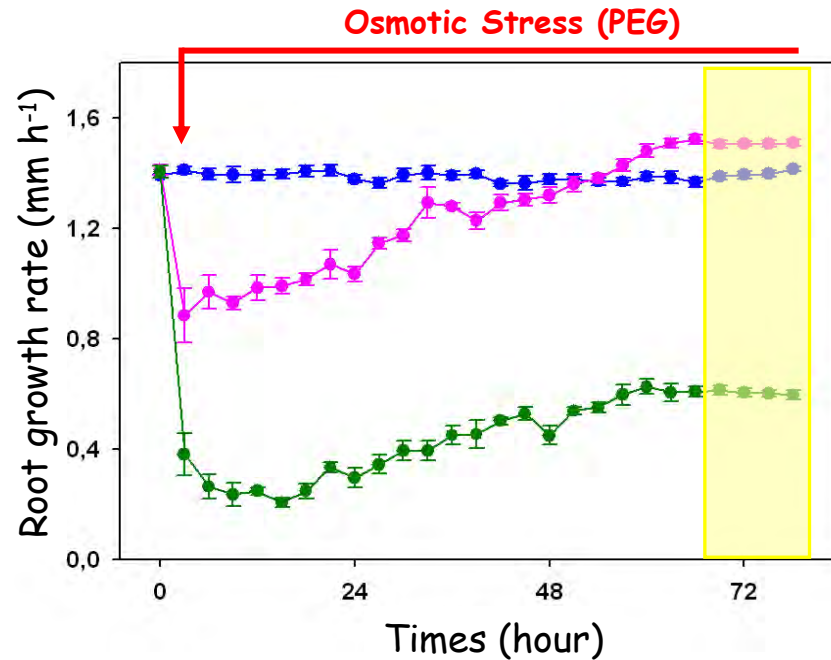

3 contrasted steady growth rates

# REGR in the root apex

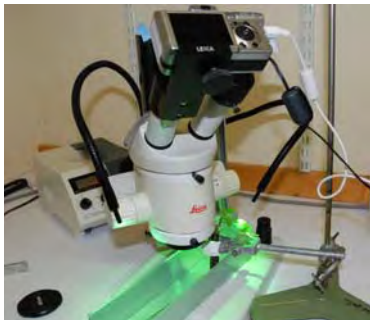
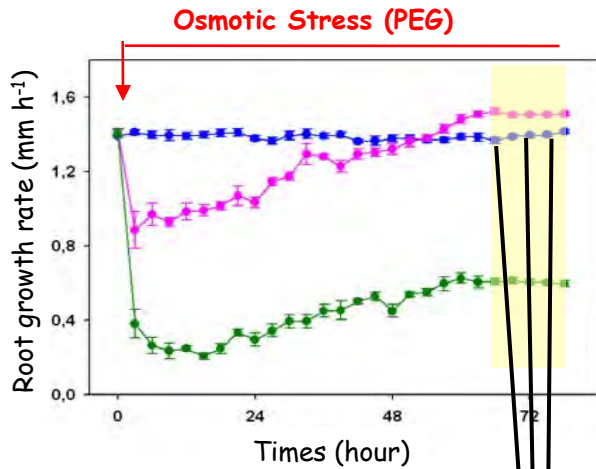

Carbon particles labelling  
+  
Kineroot  
(Basu et al, 2007)

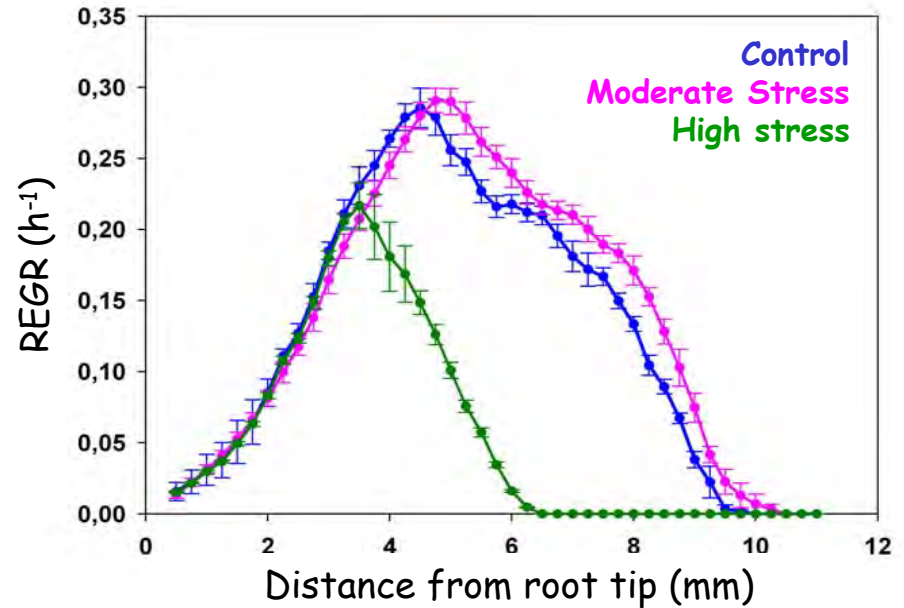
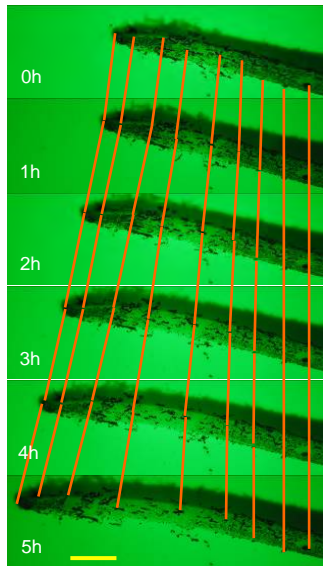

- similar REGR in [0.5-3.5 mm]
- high growth rate  $\Leftrightarrow$  long growth zone
- low growth rate  $\Leftrightarrow$  short growth zone

# Transcript density quantification

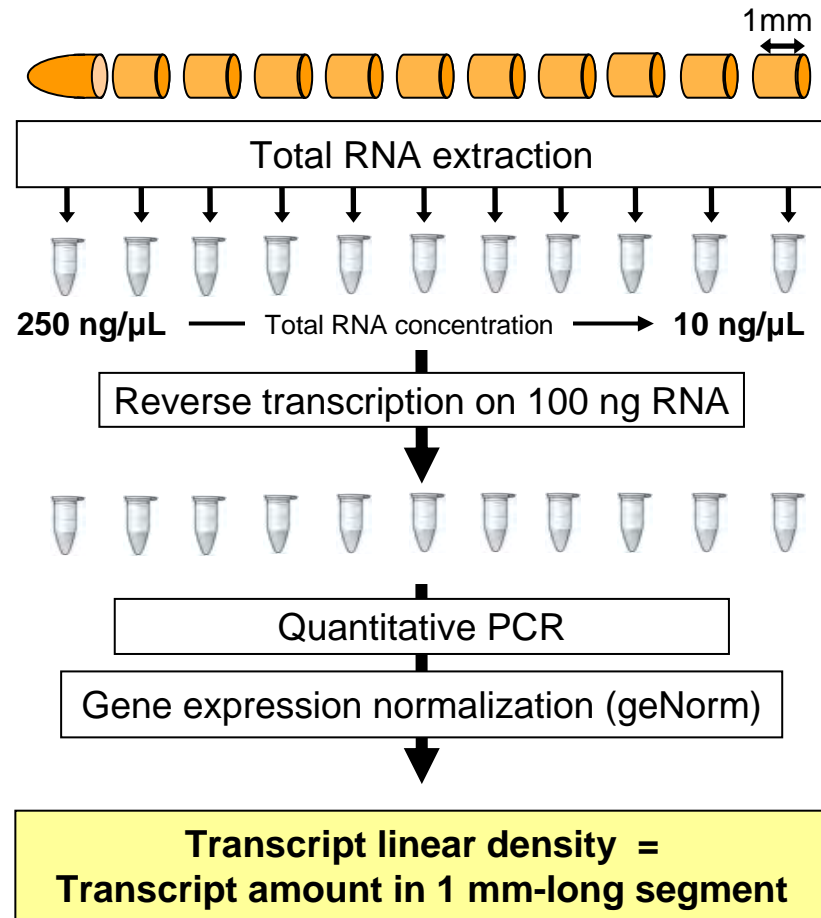

# TIP1s transcript density profiles

*PtTIP1;1* :  
reference gene  
(geNorm)

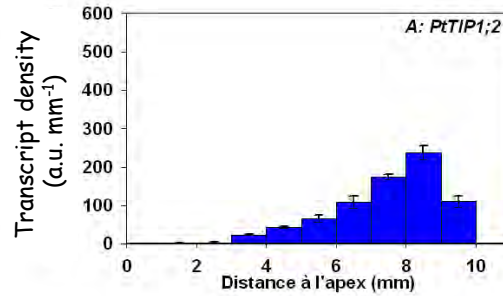

Mean  $\pm$  s.e.m. (n=3)

Among 14 analysed genes,  
*TIP1;1*: the most stable gene  
across segments and treatments

-> reference gene

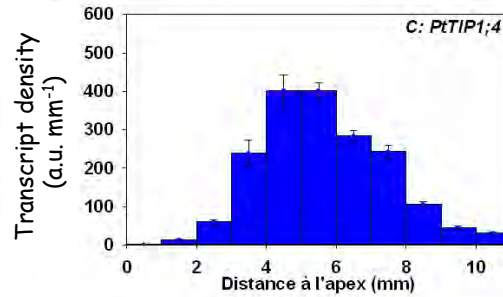
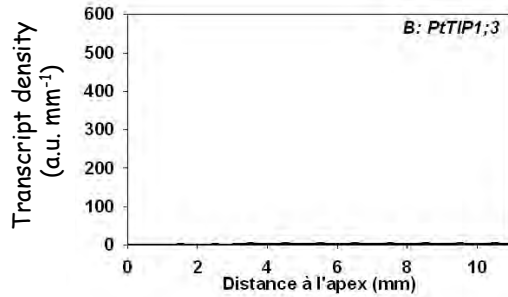

*TIP1;3* and *TIP1;8* very weakly accumulated

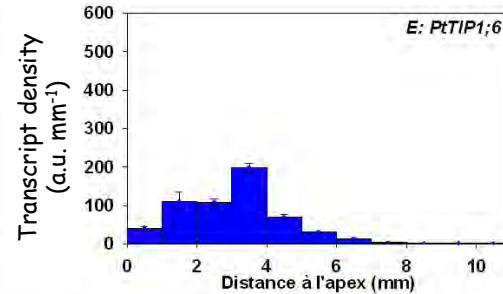
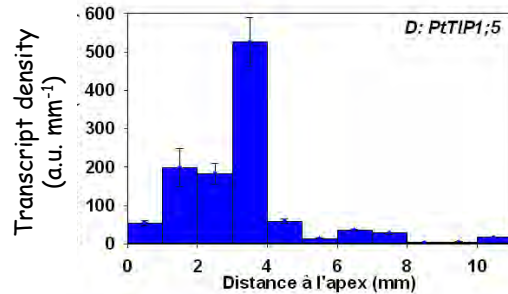

5 others : distinct accumulation patterns

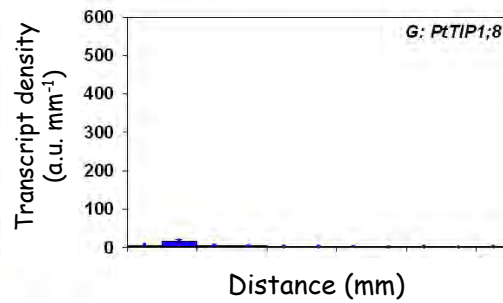
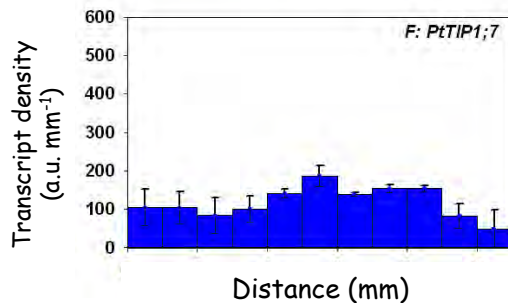

# Effect of moderate osmotic stress

Control

Moderate stress

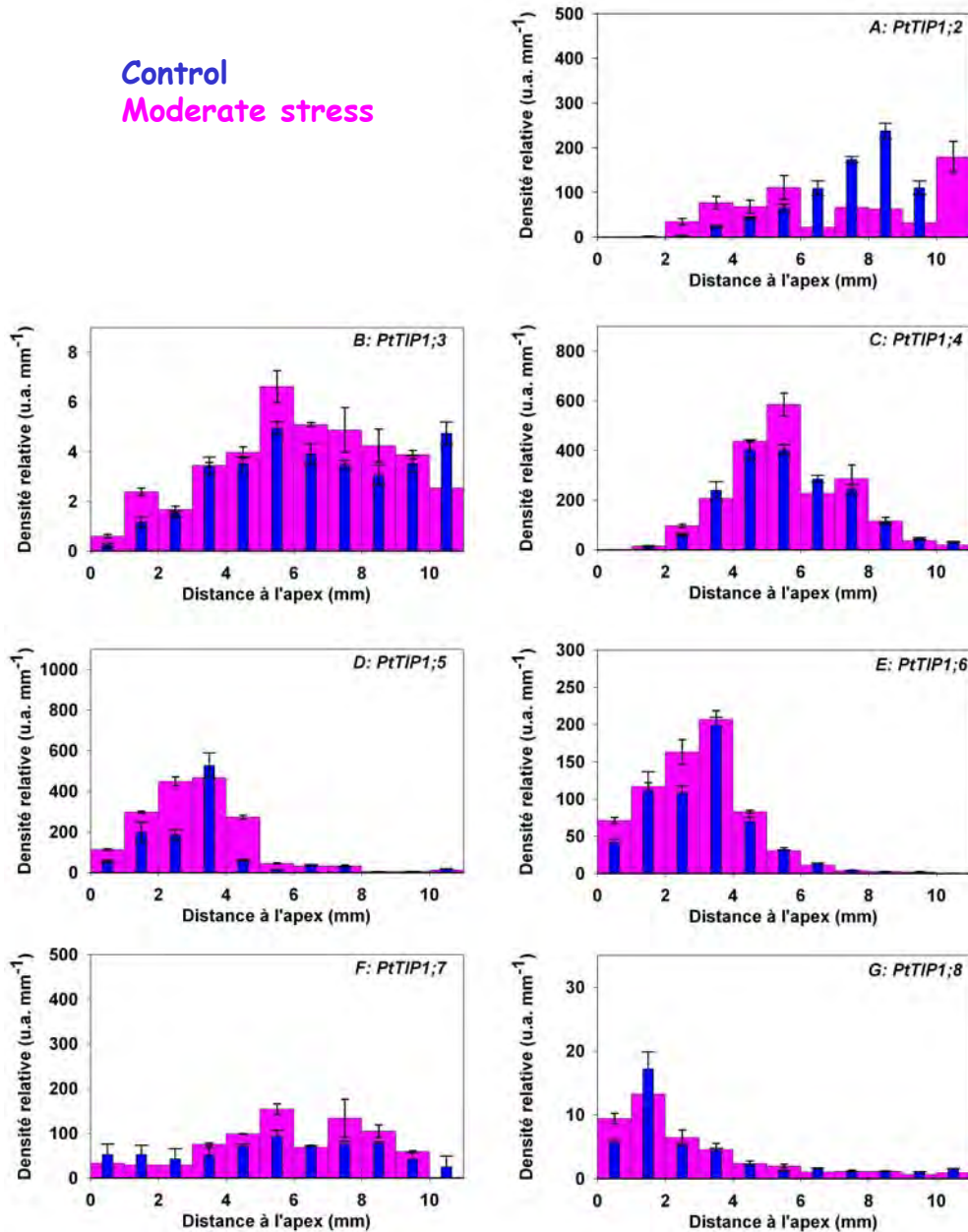

Mean  $\pm$  s.e.m. (n=3)

Low impact of moderate stress on *TIP1s* accumulation patterns (except *PtTIP1;2*)

... as on REGR profile

# Effect of high osmotic stress

Control  
High stress

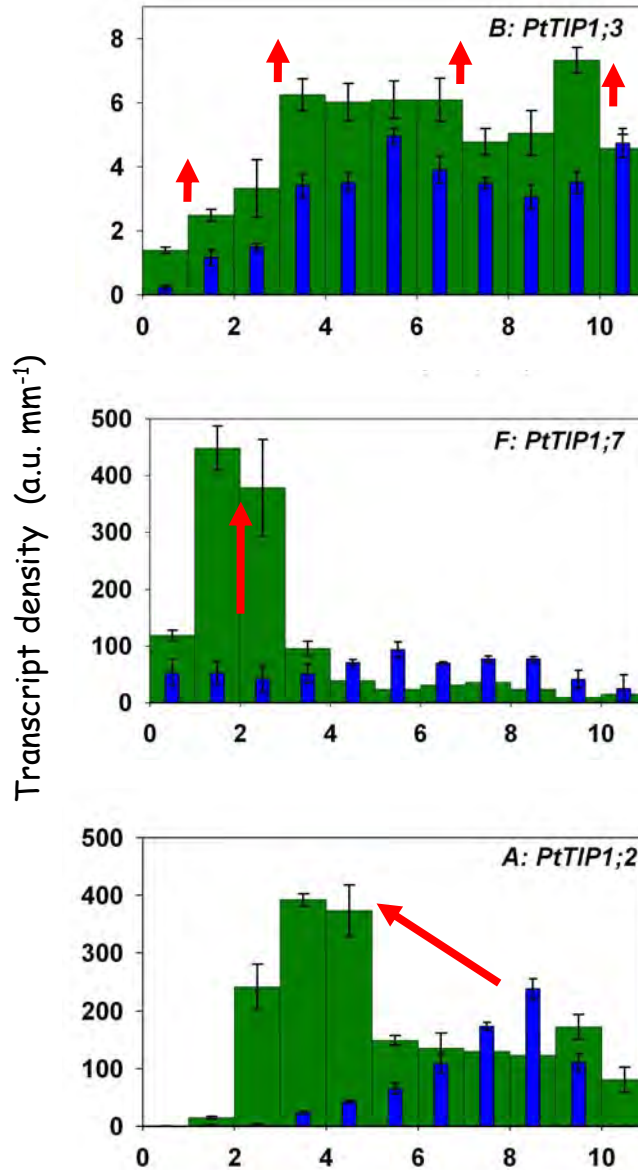

Mean  $\pm$  s.e.m. (n=3)

High stress:  
*TIP1s* accumulation patterns  
strongly and differently affected

# Expression and REGR profiles

Control  
Moderate Stress  
High stress

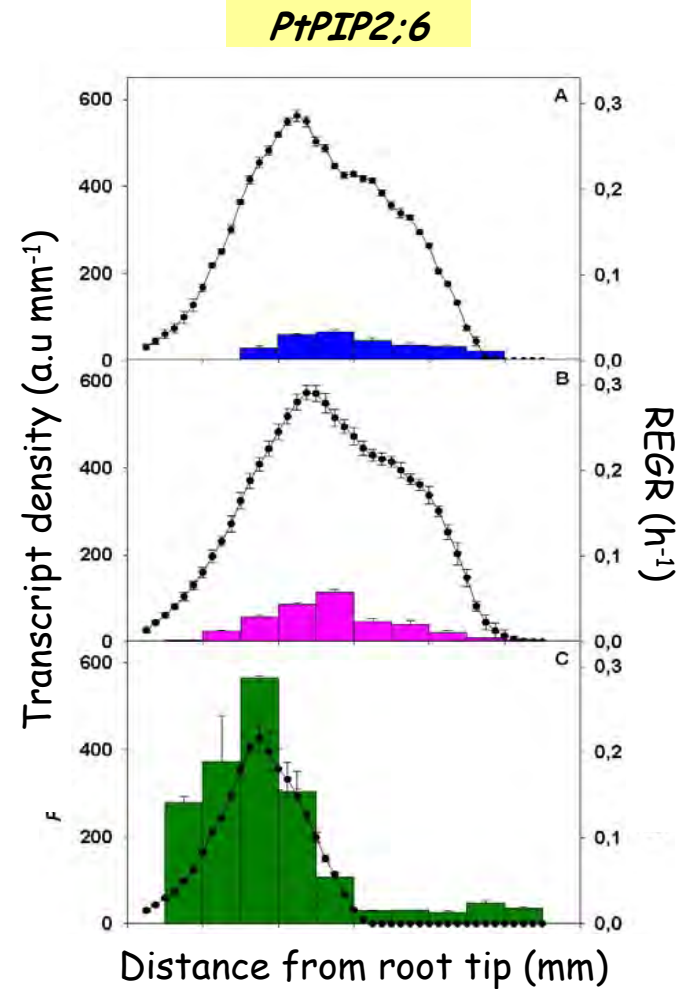
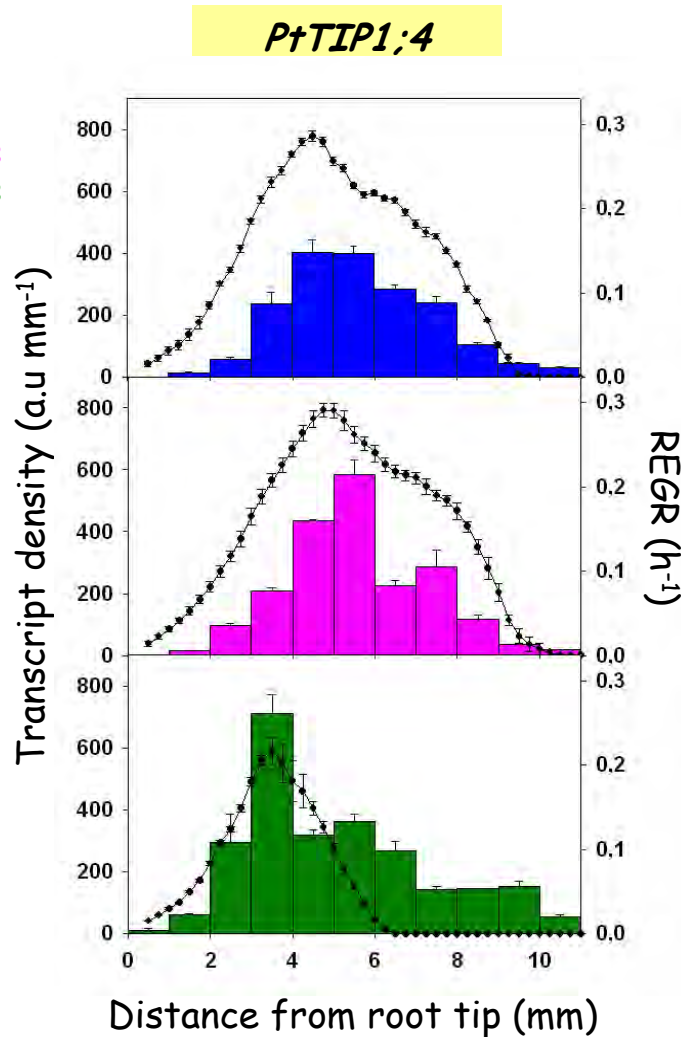

Changes of REGR profile are accompanied by similar changes in *TIP1;4* accumulation patterns



---

Transcript is not a proxy of functional protein ... but a change of expression is costly :

-> **change of transcript density has a sense in terms of maintenance/increase in protein level**

↳ for the 3 growth states, REGR and TIP1;4 patterns overlap  
-> clue for implication of TIP1;4 in cell expansion

↳ What about regulation of its expression?

# Regulation of gene expression in a growing organ?

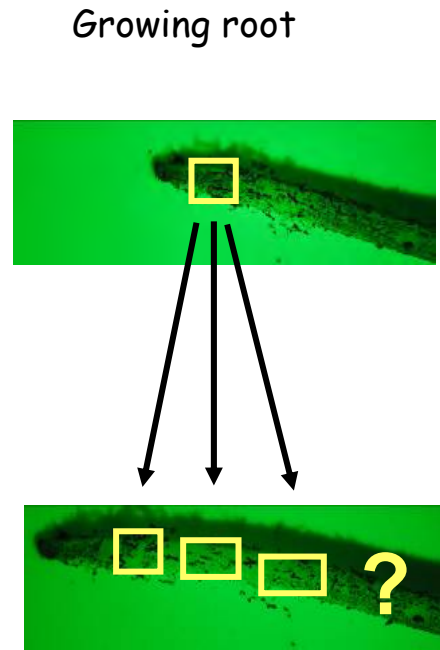
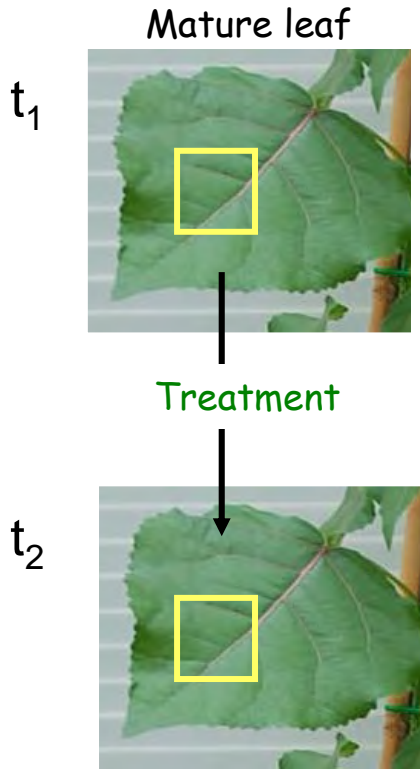

In a growing organ, it is necessary to take into account cells movement and their expansion.

Mature organ :

Gene regulation =  
temporal variation of  
transcript density  
 $\delta\rho/\delta t$

$$D_{(x)} = \underbrace{\frac{\partial \rho}{\partial t}}_{\text{Temporal variation}} + v \underbrace{\frac{\partial \rho}{\partial x}}_{\text{Convection}} + \rho \underbrace{\frac{\partial v}{\partial x}}_{\text{Dilution}}$$

The **continuity equation** (issued from a fluid mechanics formalism) gives access to the **material derivative of transcript density**, i.e., the **regulation of gene expression**

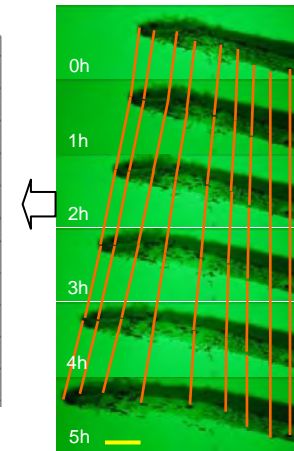
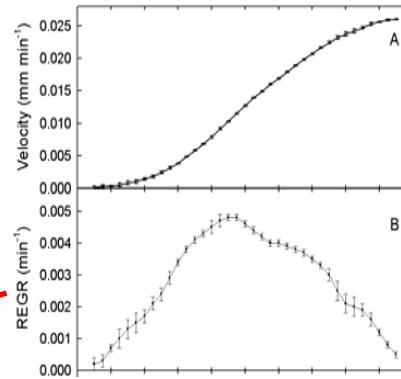
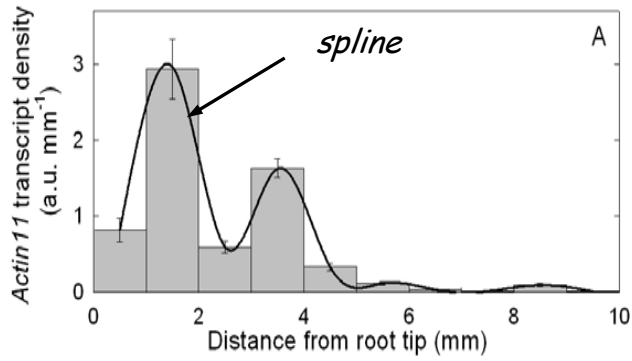

**Continuity equation**

$$D(x) = \frac{\partial \rho}{\partial t(x)} + v \frac{\partial \rho}{\partial x(x)} + \rho \frac{\partial v}{\partial x(x)}$$

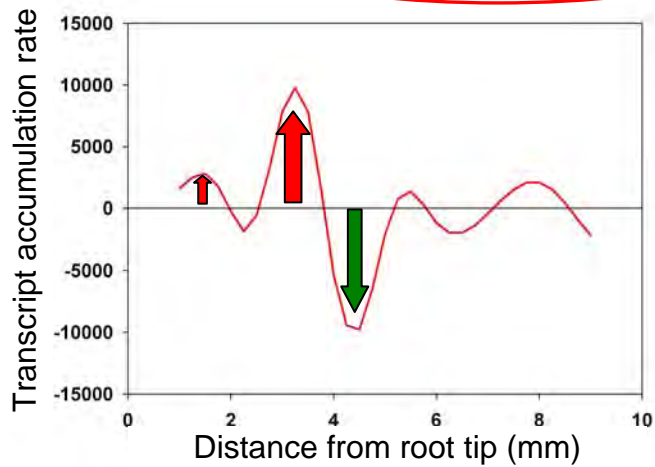

**Spatial pattern of local transcript accumulation rate at a given time point**

# Steady state and growth trajectory

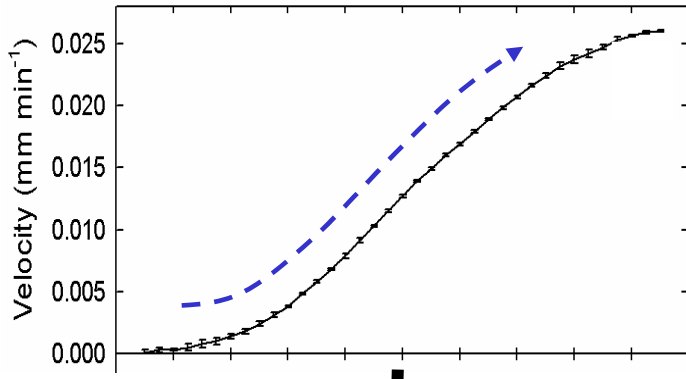

If steady state :  
integration



Growth trajectory :  $D = f(\text{Time})$

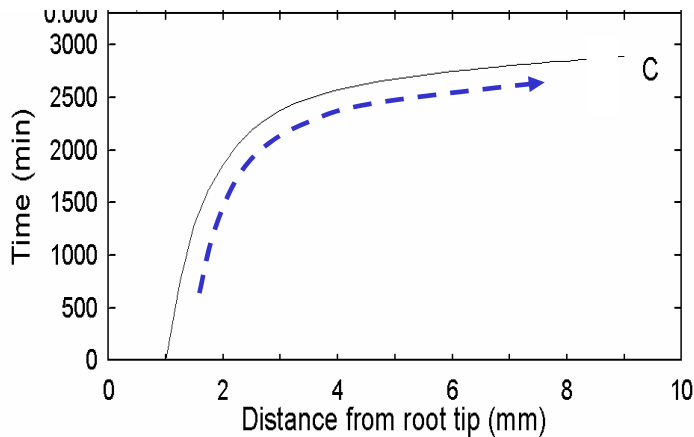

These eulerian patterns are valid for any particule  
for the "steady-state" time window

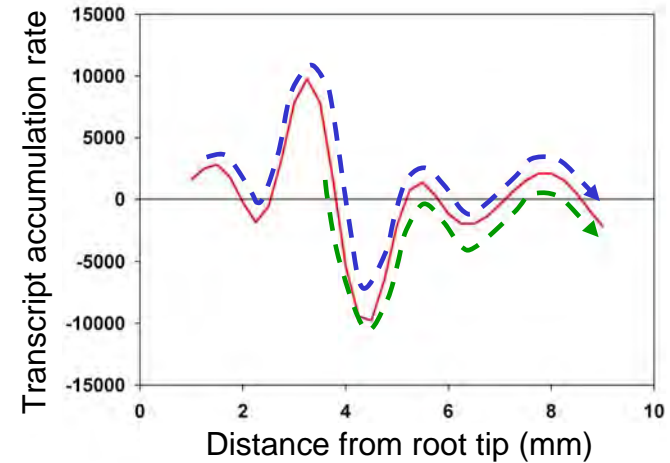

**Spatial pattern of  
transcript accumulation rate  
in a 'moving particule'**

spatial coordinates -> temporal coordinates

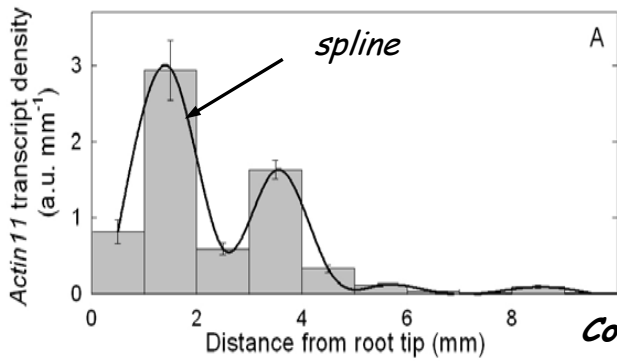

*Continuity equation*

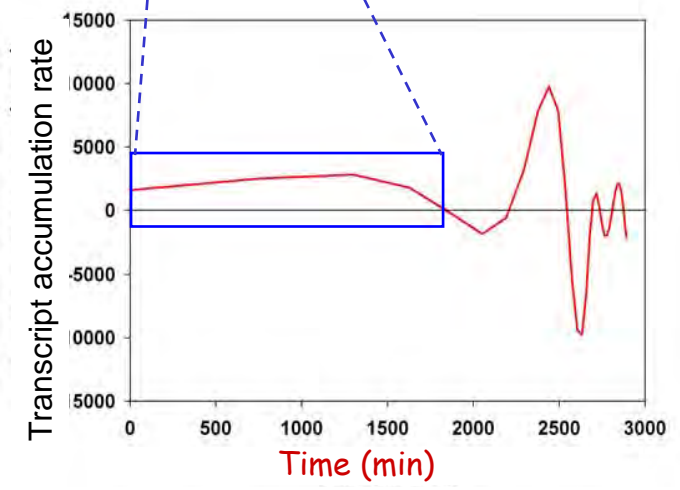
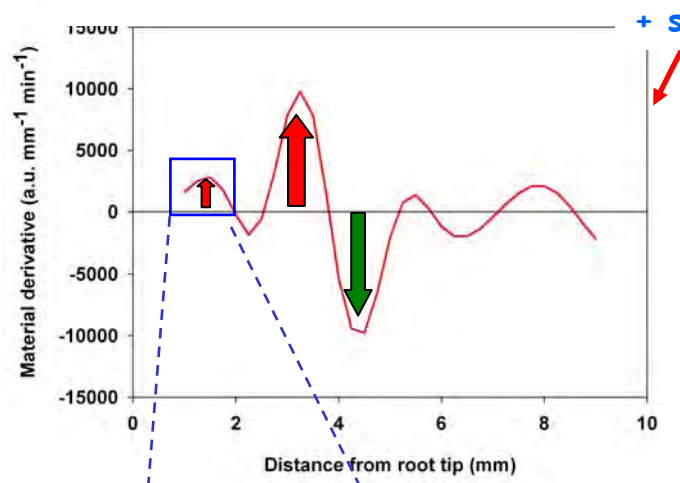
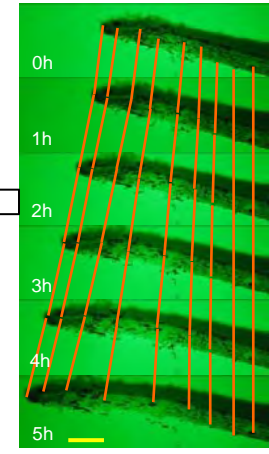
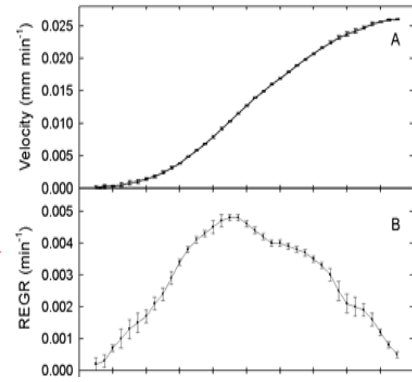

*Spatio-temporal description of regulation of gene expression in a 'moving particule'*

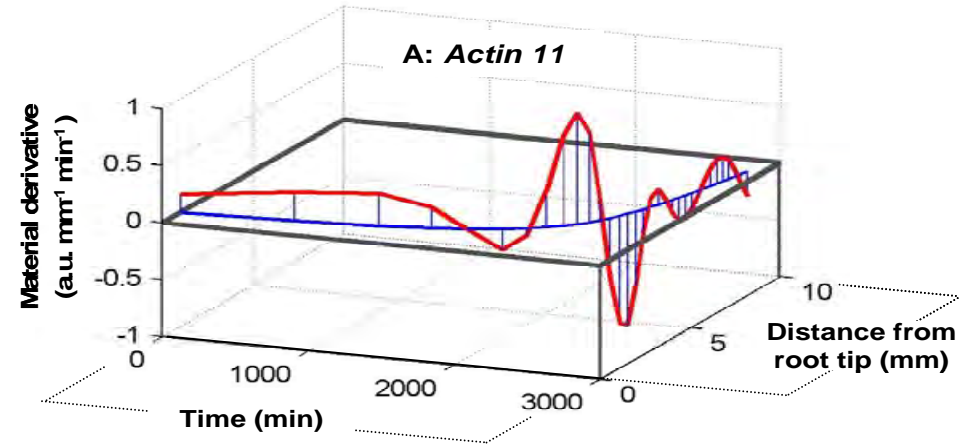

*Merret R. et al (2010)*

# Regulation of *PtTIP1;4* and *PIP2;6* expression

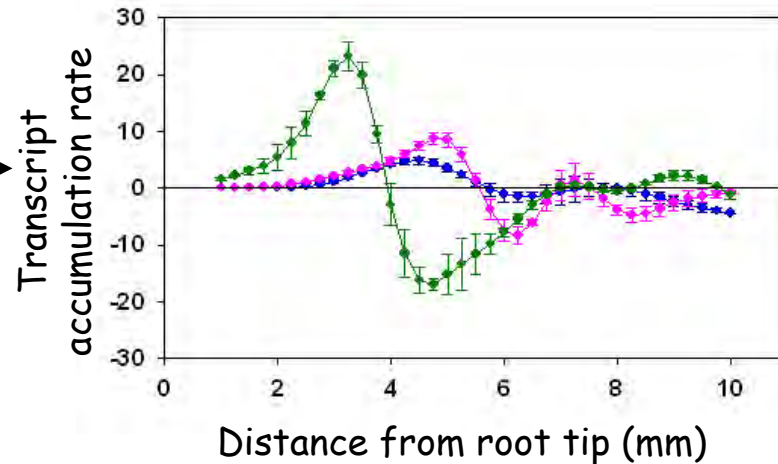
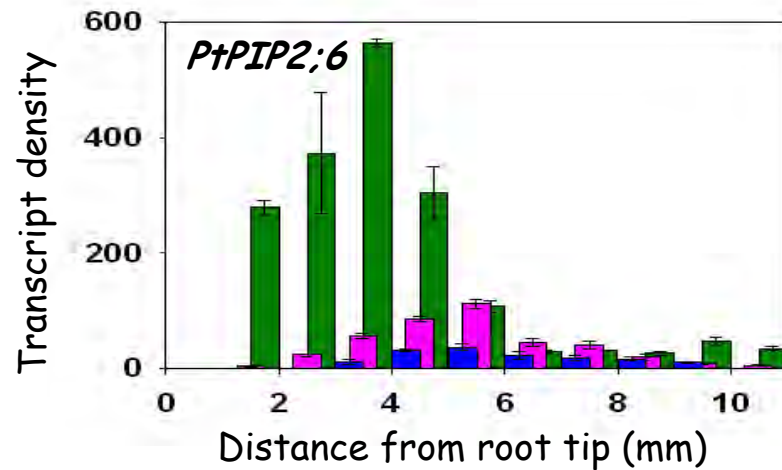
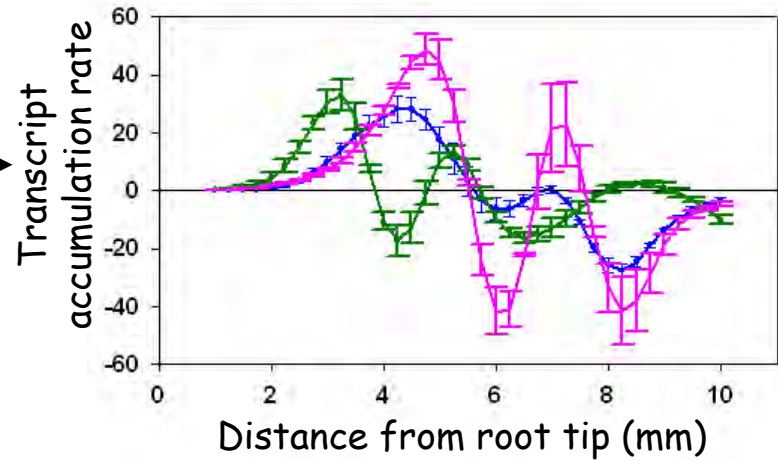
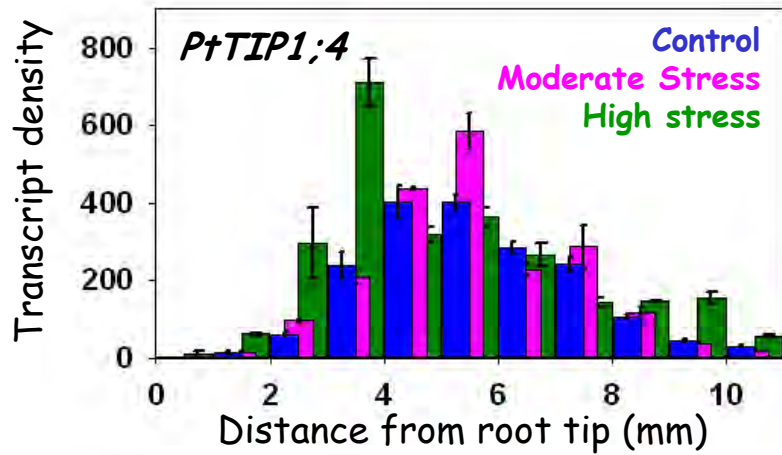

*PtTIP1;4* under high stress : high expression without higher induction  
*PtTIP2;6* under high stress : strong induction

# Reverse trajectory

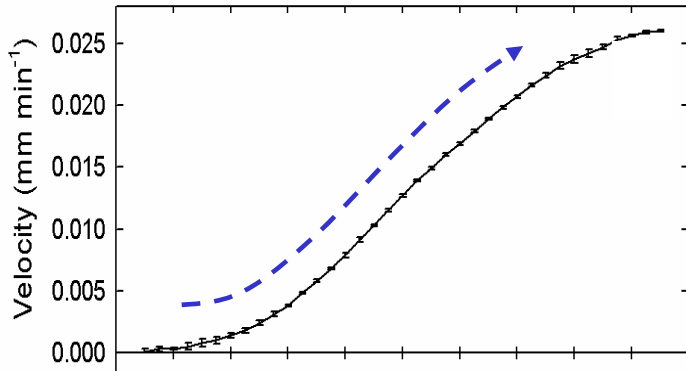

If steady state : integration



Growth trajectory :  $D = f(\text{Time})$

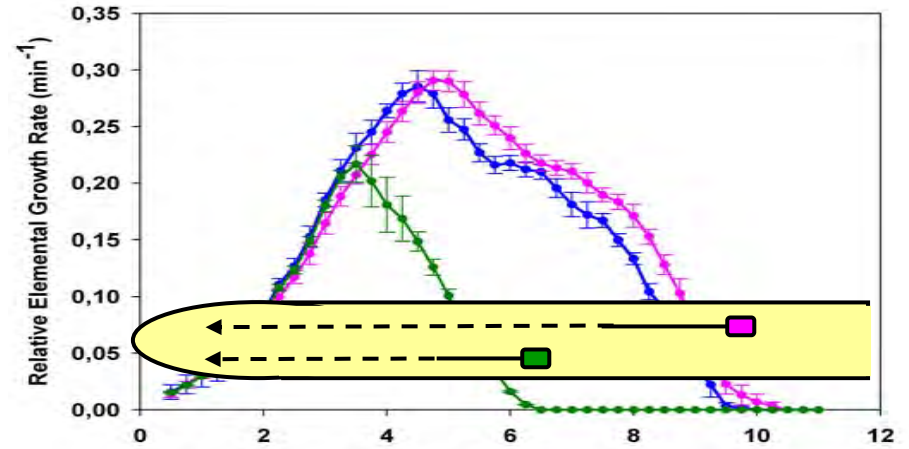
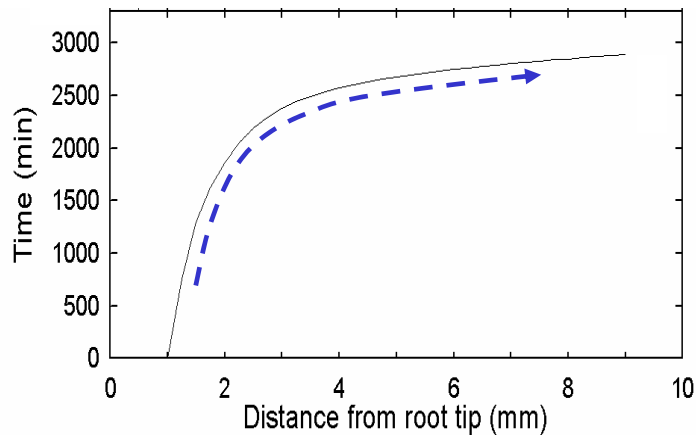

Growth trajectories of the cells just finishing their expansion for the preceding 20h

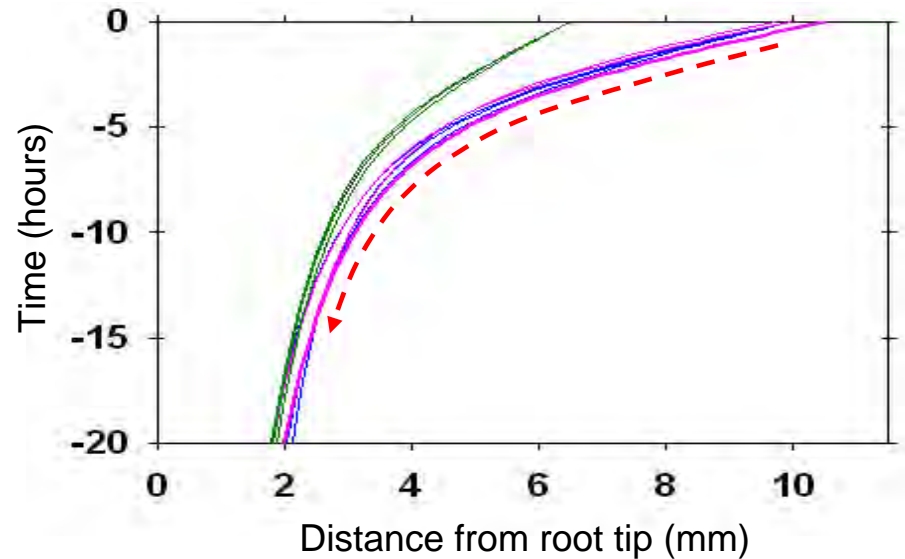

# Spatial and temporal patterns of regulation of TIP1;4 expression

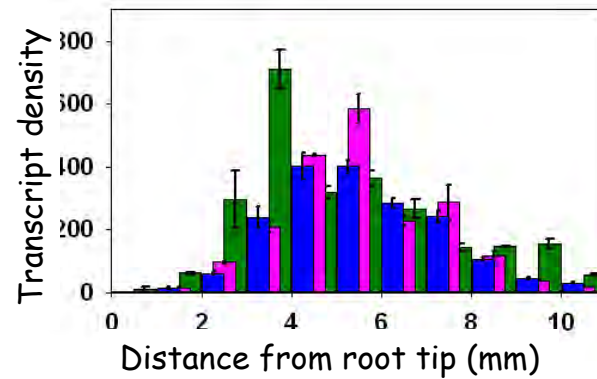
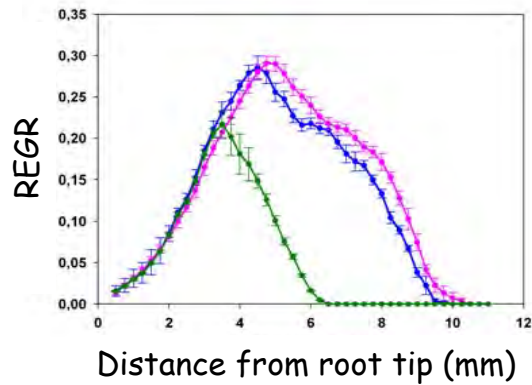

Control

100g/L PEG (90 mosmol/kg)

200g/L PEG (260 mosmol/kg)

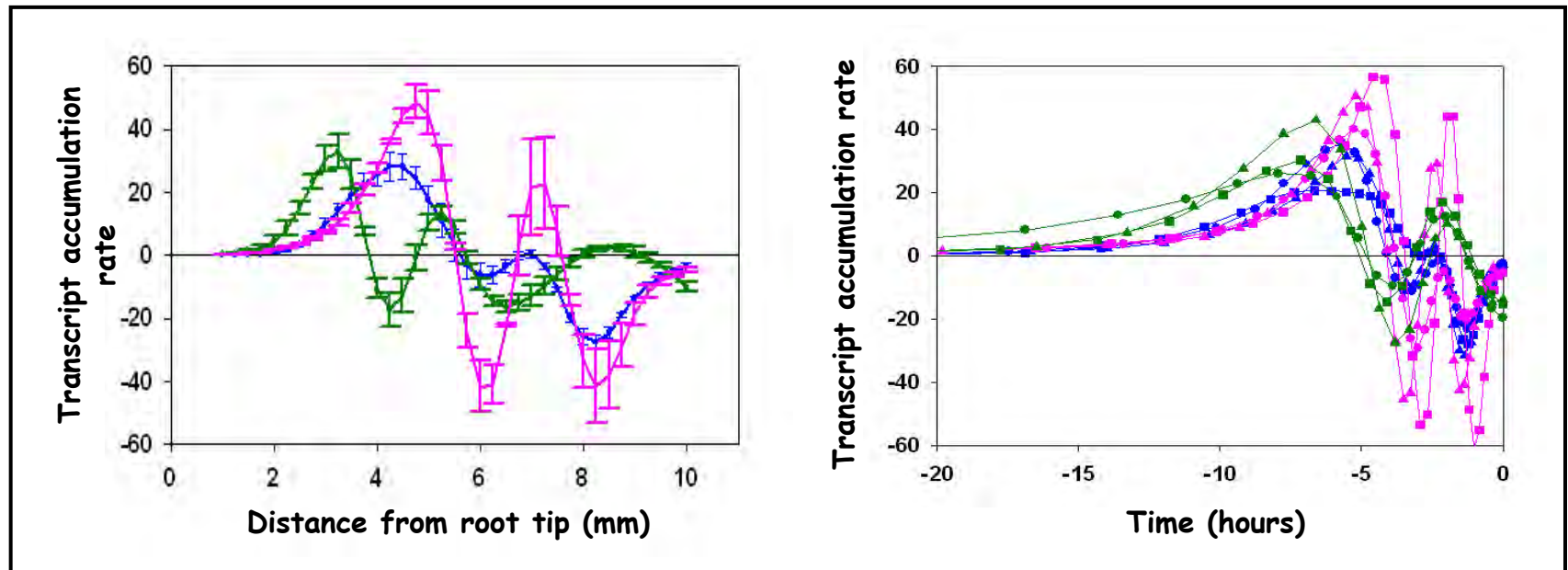

Contrasting spatial patterns but similar temporal patterns  
The regulation of TIP1;4 expression seems to be temporally governed



- ↪ analyse the regulation patterns of other *TIP1s*
- ↪ immunolocation of aquaporins
- ↪ use the framework to analyse the molecular control of synchrony between cell division and cell elongation

# Hydraulic safety of *Pinus pinaster* needles

Katline Charra-Vaskou,  
Régis Burlett, Sylvain Delzon,  
Stefan Mayr

6th april 2011  
Xylem colloquium, Nancy

**Institute of Botany,  
Innsbruck University,  
Austria**

**UMR BIOGECO,  
Bordeaux 1 university,  
France**



# Hydraulic architecture

- 🌲 Soil-plant-atmosphere continuum
- 🌲 Efficiency of the plant hydraulic system

- ↳ Roots
- ↳ Axes
- ↳ Leaves

- 🌲 Plant hydraulic resistance:

- ↳ Water potential in the plant
- ↳ Water availability for tissues

- 🌲 Aim:

Analysis of vulnerability to drought-induced loss of conductivity in needles of *Pinus pinaster*

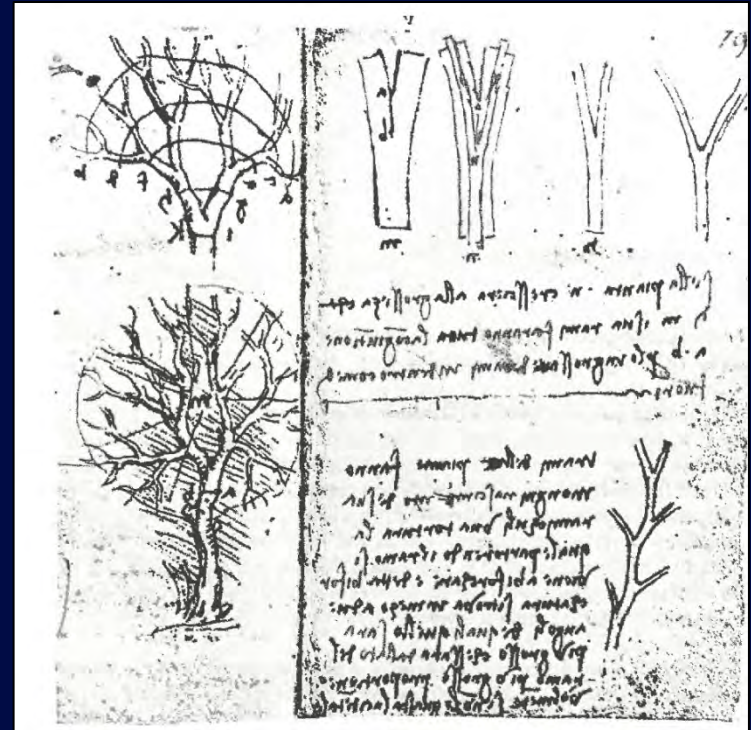

Leonardo da Vinci



Material:

*Pinus pinaster*

Twigs and needles



Methods:

1. Cavitron
2. Rehydration kinetics method
3. Ultrasonic acoustic emission analysis



# Needle hydraulic conductivity

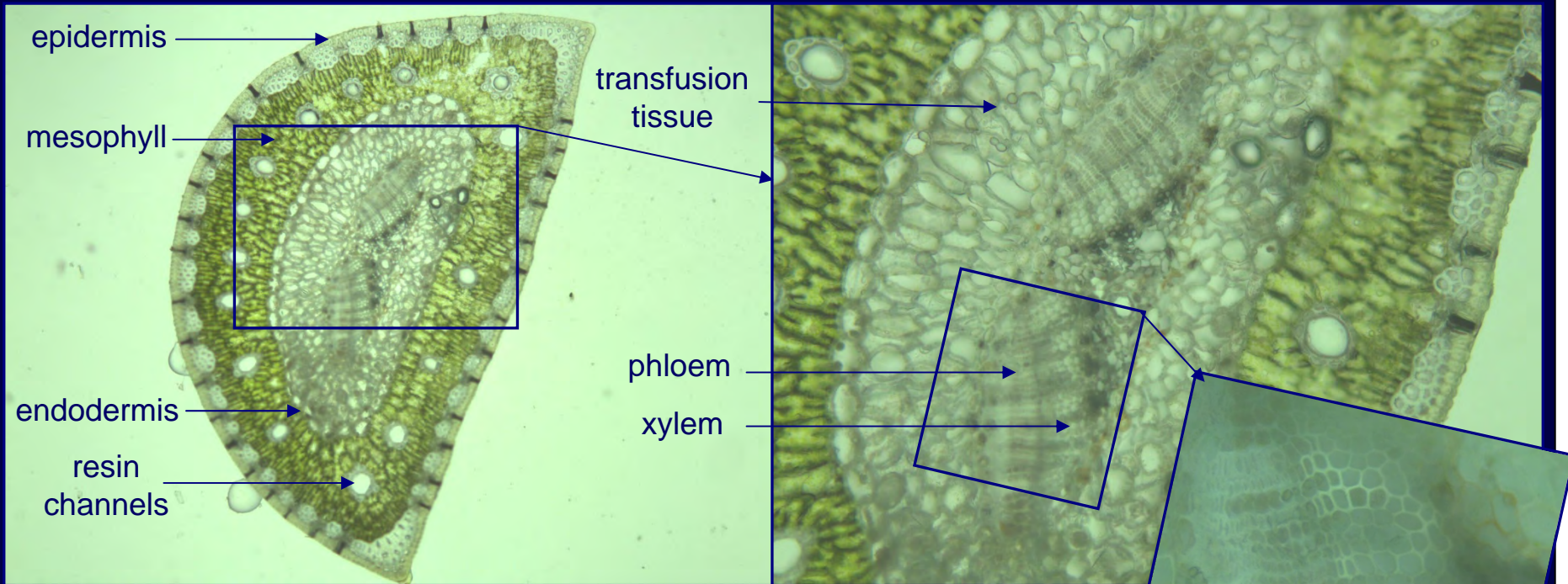

Cross section of *Pinus pinaster* needle

🌲 Xylem: conductivity is influenced by tracheid diameter, tracheid length and the number of pit connections

🌲 Extra-vascular pathway: transfusion tissue, mesophyll



🌲 *Pinus pinaster*

↳ needles

mean length: 14 to 18 cm

↳ twigs

🌲 Campus of Talence, Bordeaux



🌲 Needle preparation:

↳ Branches harvested the day before

↳ Cut under water

↳ Rehydrated in refrigerator with plastic bag

## Cavitron

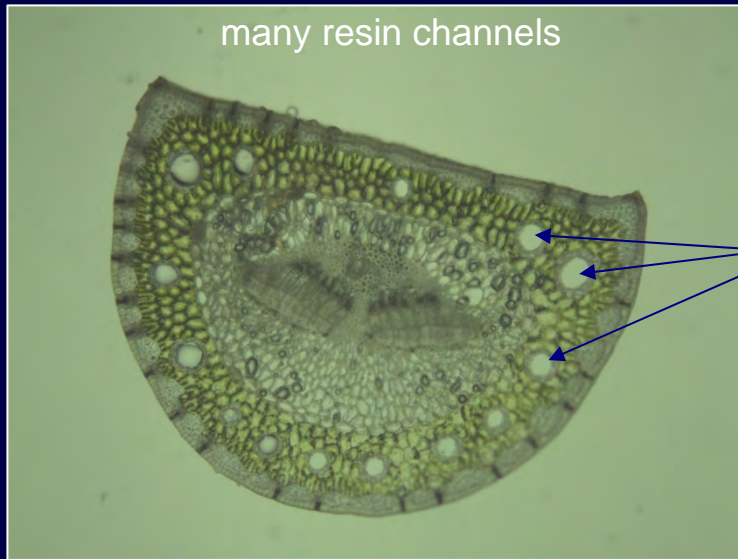

resin channel

phloem  
xylem

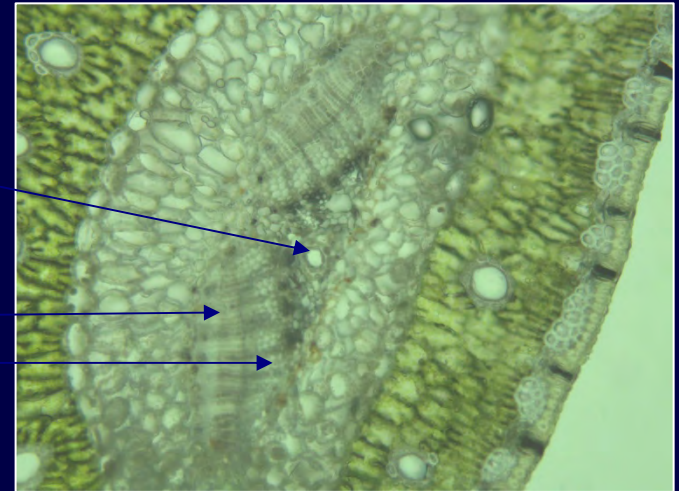

To avoid emptying of resin channels:

- Needles immersed 1 hour in cold water ( 5 – 7°C)
- Needles cut 2 times (15 minutes interval)
  - ↳ Resin channels blocked
  - ↳ Resin does not block xylem



## Cavitron

### Preparation for cavitron measurements:

- 🌲 Cooled centrifuge and rotor (5 to 7°C)
- 🌲 Needle length (after cutting) : 14,5 cm
- 🌲 20 needles inserted in water reservoir

### Cavitron measurements:

- 🌲 Procedure according to Cochard et al., 2005
- 🌲 Temperature cavitron at 5 to 7°C during the measurement
- 🌲 Use of software “Cavisoft” (Regis Burlett, Biogeco)
- 🌲 Problem: Measurements take long time (3 to 4h cavitron measurement per sample)



# Acoustic

2 well hydrated twigs

8 sensor

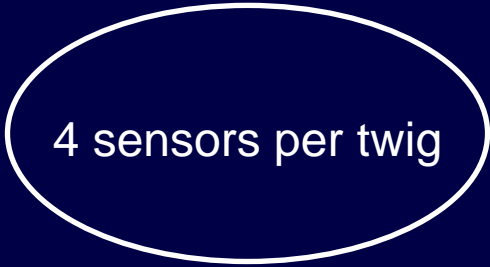

2 Sensors on  
STEMS

6 Sensors on  
NEEDLES



## Acoustic

While acoustic emission measurement were made, branches were slowly dehydrating (bench dehydration) and water potentials were measured every 6 to 12 hours (Scholander apparatus).

stems used for UAE  
measurements



Needles used for water  
potential measurements

Needles used for UAE  
measurements



## Rehydration kinetics measurements

- 6 well hydrated branches were slowly dehydrated (bench dehydration) from -0,3 to -3 MPa
- Before measurements, branches were bagged and put in the refrigerator to ensure homogeneous  $\Psi$  among needles
- Many times during dehydration of branches:  
Measurements according to “Brodribb and Holbrook, 2003)
  - 2 needles: initial water potential (Scholander apparatus)
  - 4 needles: rehydration measure and final water potential

# Rehydration kinetics measurements

Measurement of initial water potential ( $\Psi_0$ )

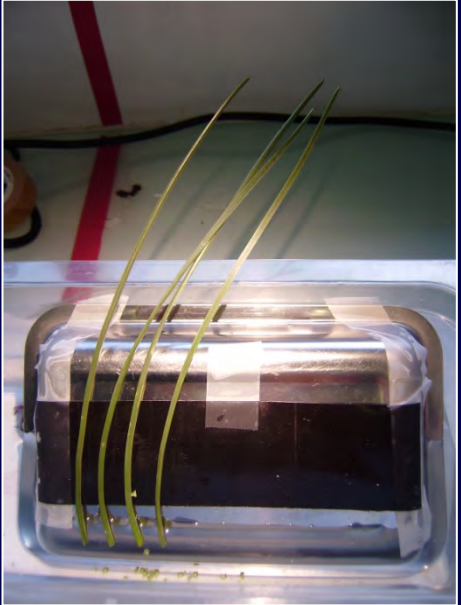

Time « t » in distilled water



Measurement of final water potential ( $\Psi_f$ )

Capacitance  $C_N$   
[ $\text{mol}\cdot\text{m}^{-2}\cdot\text{MPa}^{-1}$ ]



Conductance  $K_N$   
[ $\text{mmol}\cdot\text{m}^{-2}\cdot\text{s}^{-1}\cdot\text{MPa}^{-1}$ ]

$$K_N = C_N * \ln (\Psi_0 / \Psi_f) / t$$

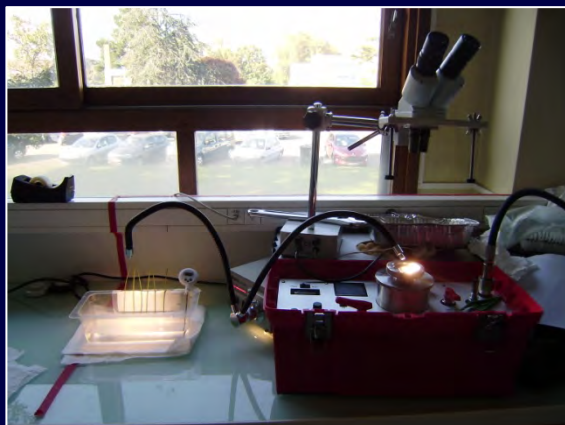

# Rehydration kinetics measurements

Needle capacitance  $C_N$ :

$$C_N = \Delta RWC / \Delta \Psi * (DW/LA) * (WW/DW) / M$$

**DW**: leaf dry weight (g); **LA**: leaf area (m<sup>2</sup>); **WW**: mass of leaf water at 100% RWC (g); **M**: molar mass of water (g.mol<sup>-1</sup>)

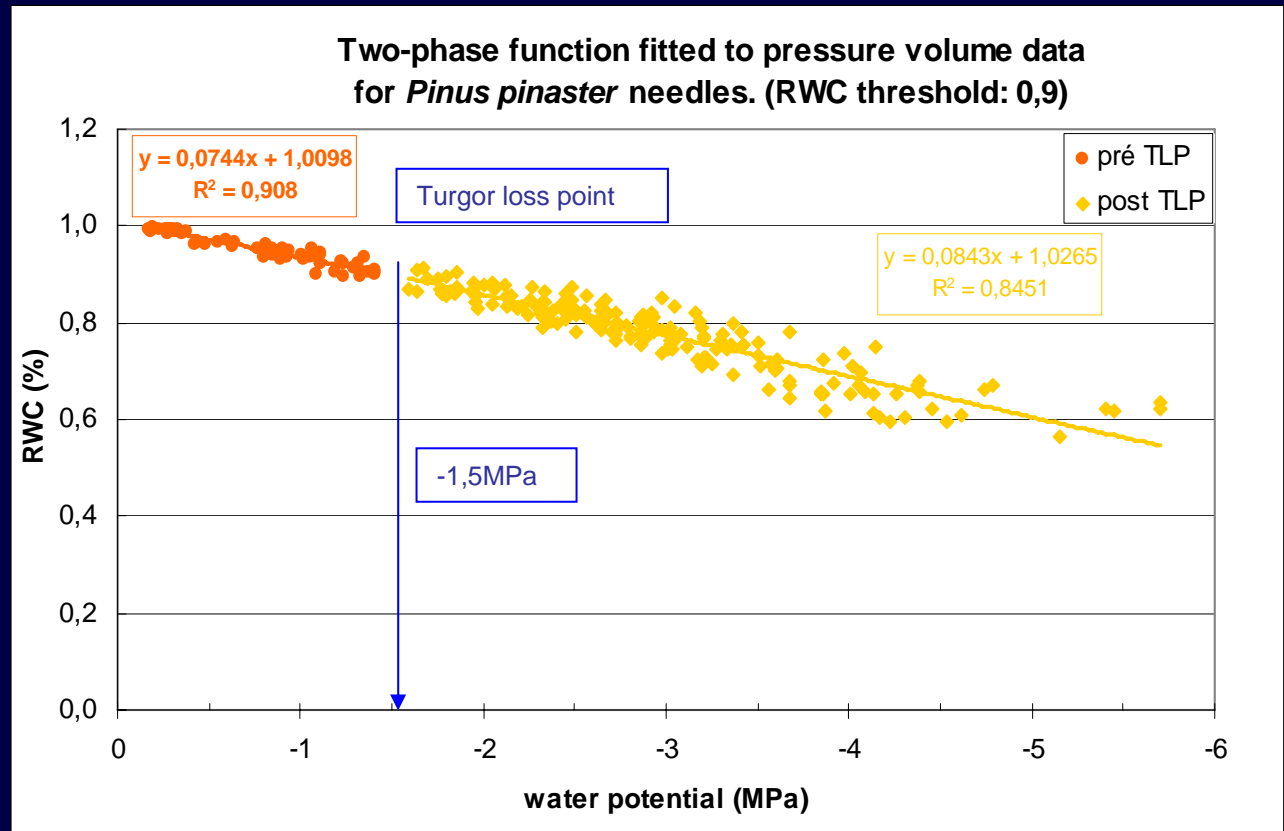
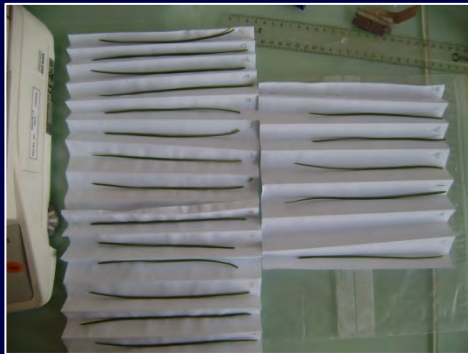

Needle conductance

$$K_N = C_N * \ln (\Psi_0 / \Psi_f) / t$$

## Cavitron measurements

Vulnerability curves of *Pinus pinaster* needles and twigs

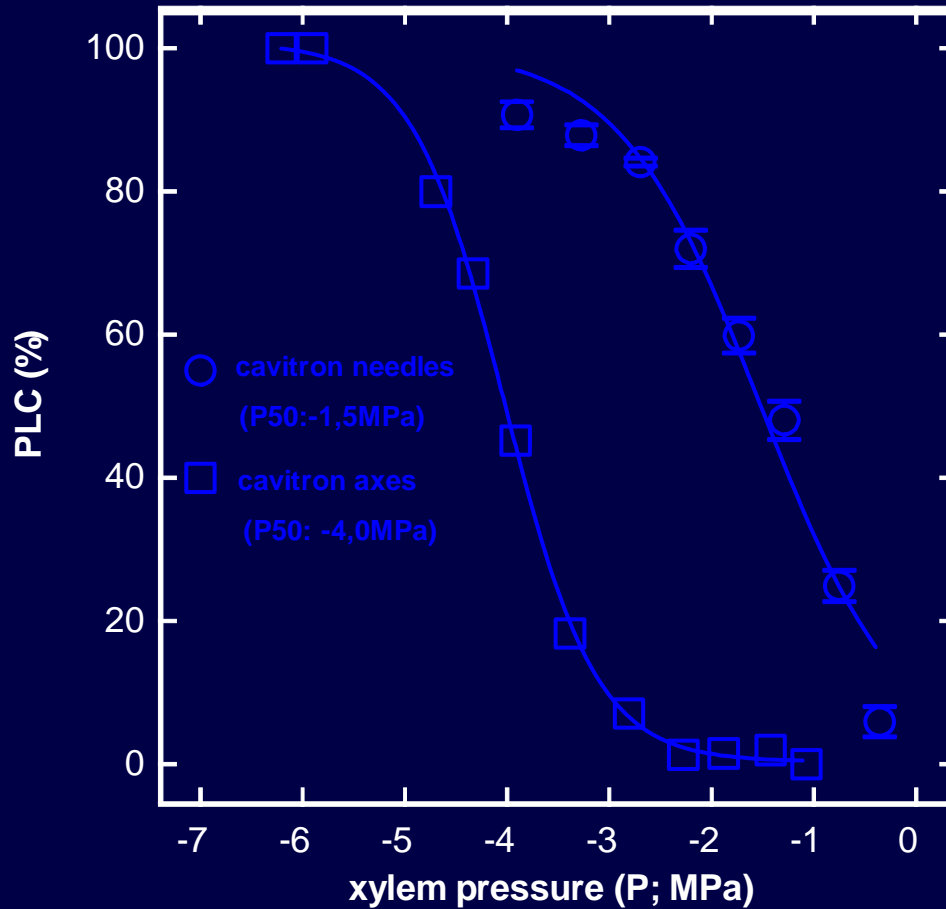

  $\Psi_{50}$  needles: -1,5 MPa

  $\Psi_{50}$  twigs: -4,0 MPa

## Acoustic measurements

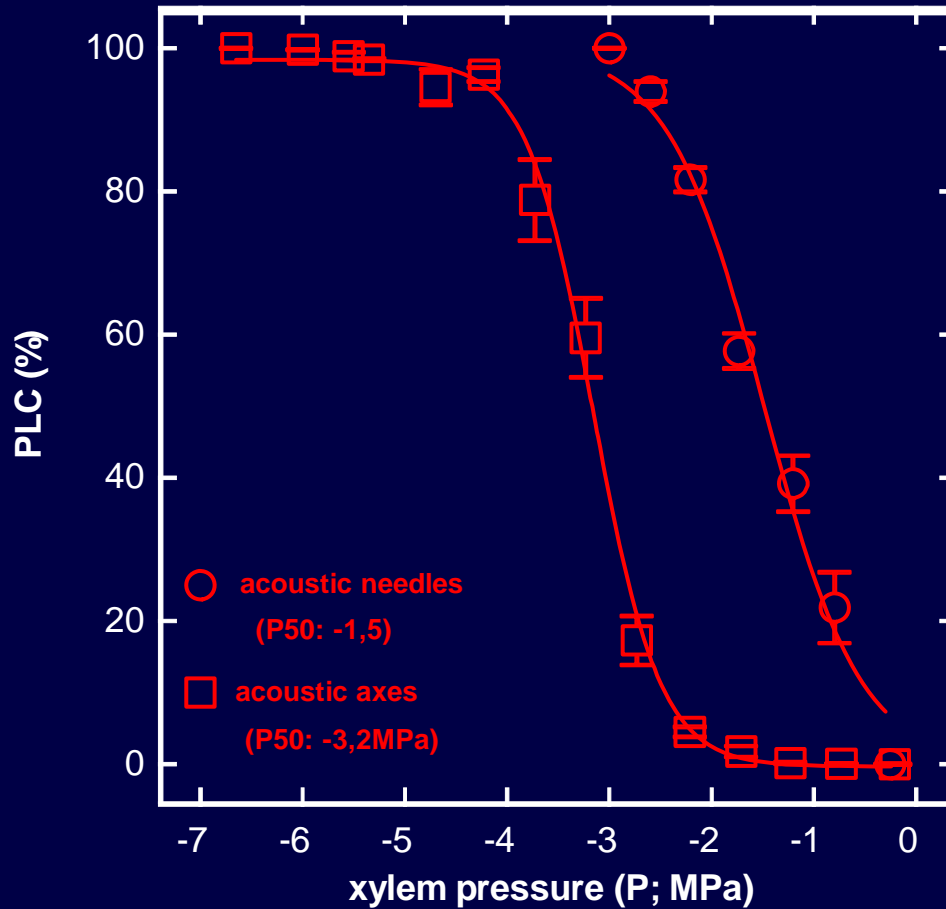
Vulnerability curves of *Pinus pinaster* needles and twigs  $\Psi_{50}$  needles : -1,5 MPa  $\Psi_{50}$  twigs : -3,2 MPa

## Rehydration kinetics measurements

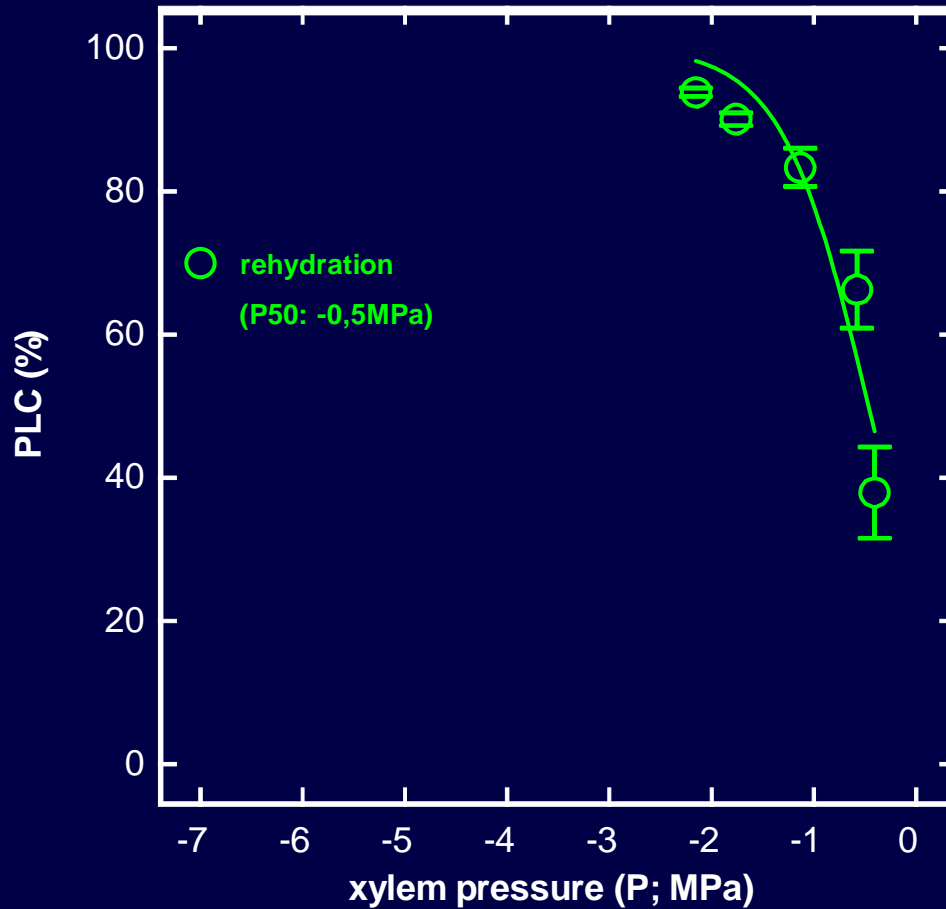
Vulnerability curve of *Pinus pinaster* needles  $\Psi_{50}$  needles: -0,5 MPa



## *Pinus pinaster* needles vulnerability

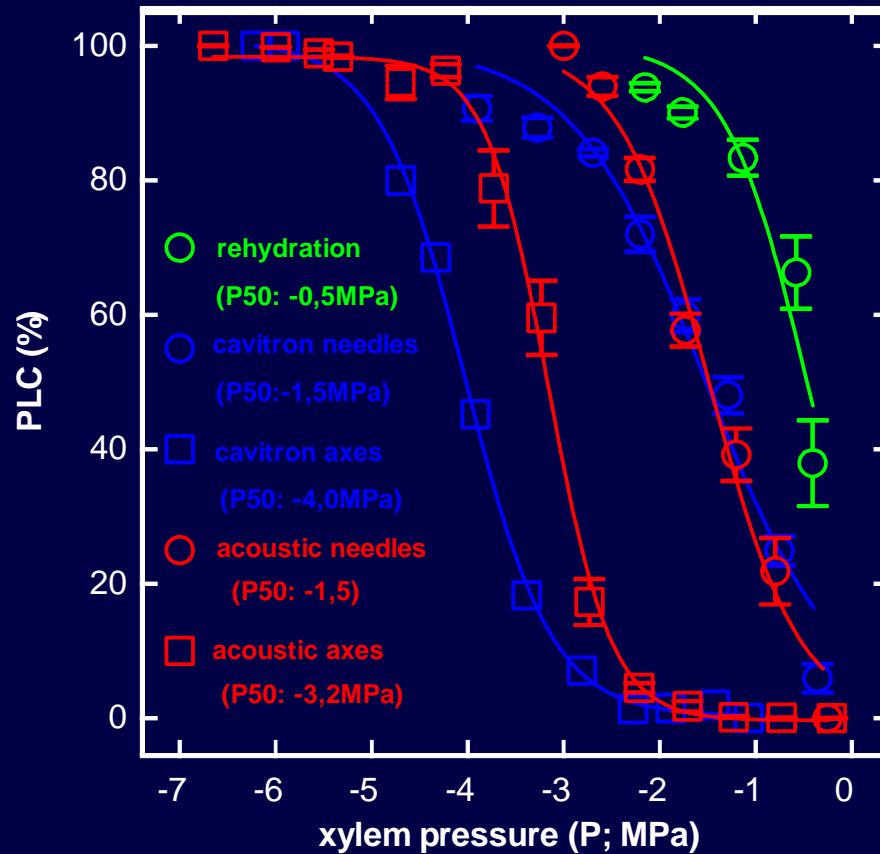

$\Psi_{50}$  needles

-0,5MPa (rehydration)

-1,5 MPa (cavitrion)

-1,5 MPa ( acoustic)



Quite similar results between cavitrion and acoustic



High  $\Psi_{50}$  with rehydration kinetics method

## *Pinus pinaster* vulnerability

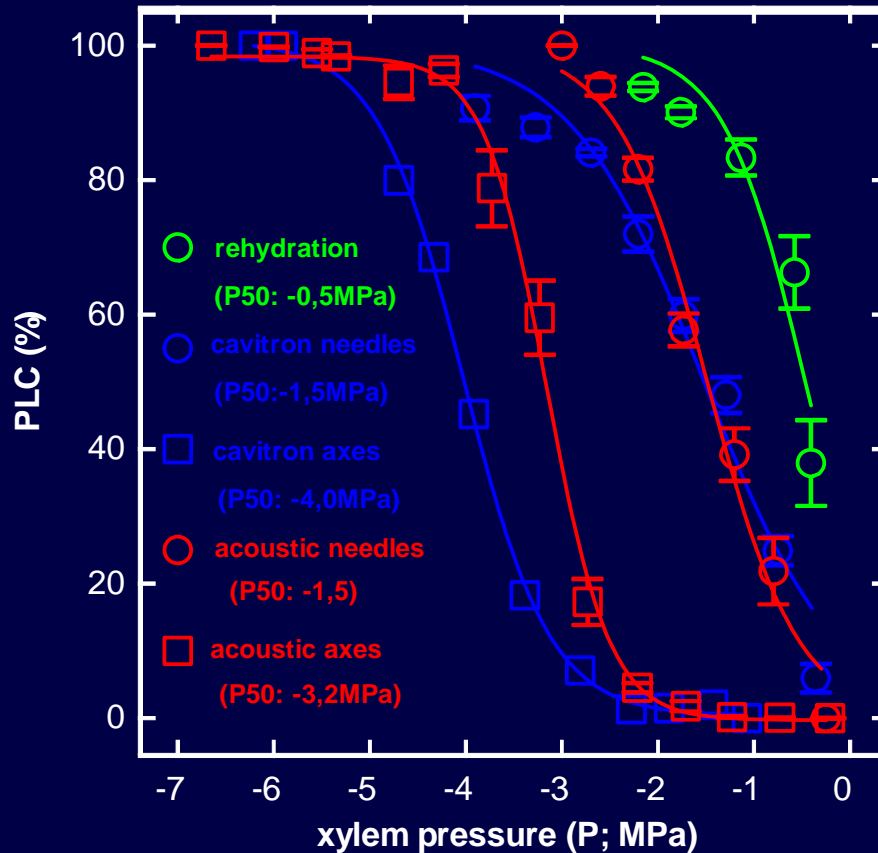

Ψ 50 needles  
-0,5MPa (rehydration)

-1,5 MPa (cavitrion)

-1,5 MPa ( acoustic)

Ψ 50 branches

-4,0 MPa (cavitrion)

-3,2 MPa ( acoustic)



Quite similar results between cavitrion and acoustic



High Ψ50 with rehydration method



Loss of conductivity in needles occurs before cavitation in branches

## *Pinus pinaster* vulnerability

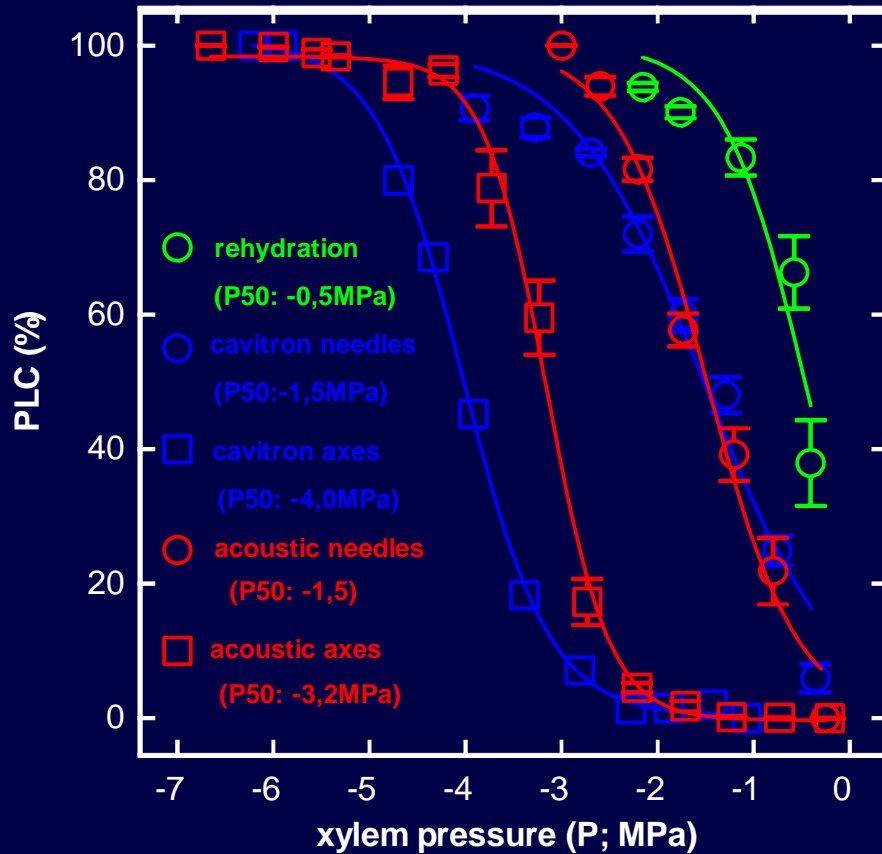

Overall high  $\Psi_{50}$  in needles

 Methodical problems?

 Vulnerability of needles:

 cavitation?

 Collapse? (fast recovery)

 Something else?

$\Psi_{50}$	needles	twigs
acoustic	-1,5 MPa	-3,2 MPa
cavitron	-1,5 MPa	-4,0 MPa
rehydration	-0,5MPa	

 Is the needle capacitance related to  $\Psi_{50}$  in needles?

## Cavitation ou collapse?

hit energy from twigs and needles during dehydration  
(acoustic measurements)

Twigs

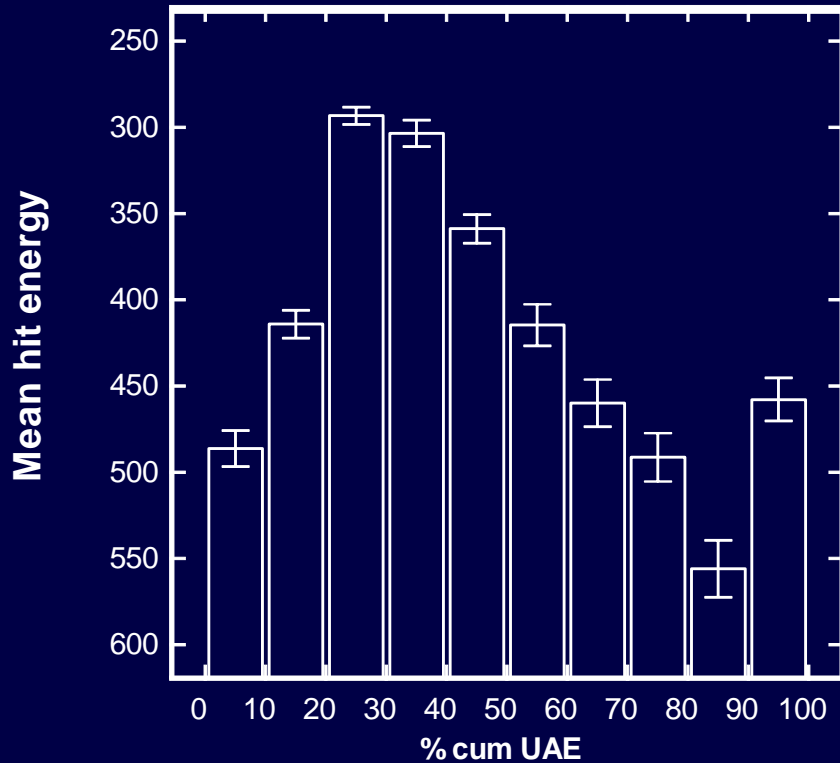

Needles

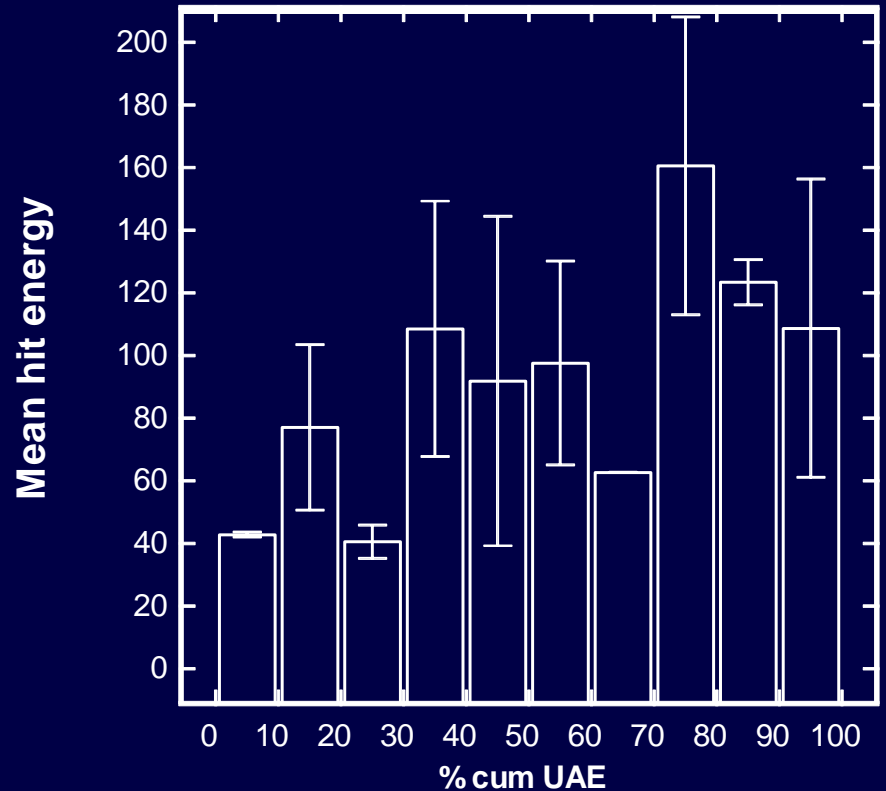

Most energy between 20 to 40 % of cum UAE



“cavitation pattern” in twigs



Less energy than in twigs



Complex pattern

## Cavitation ou collapse?

Epifluorescence technique on frozen samples

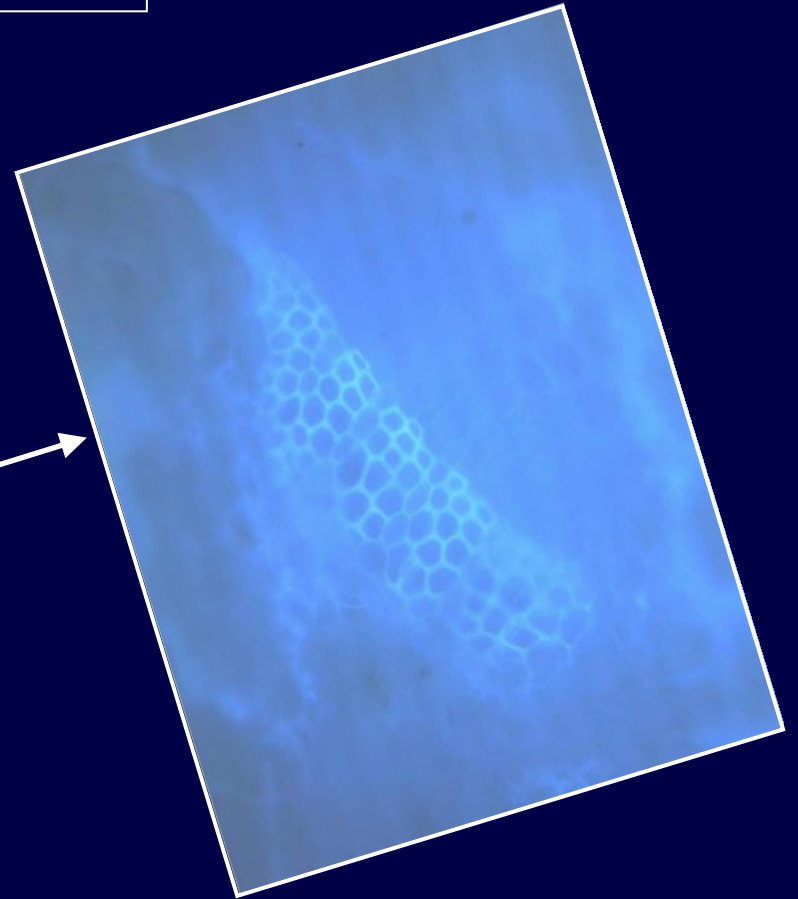
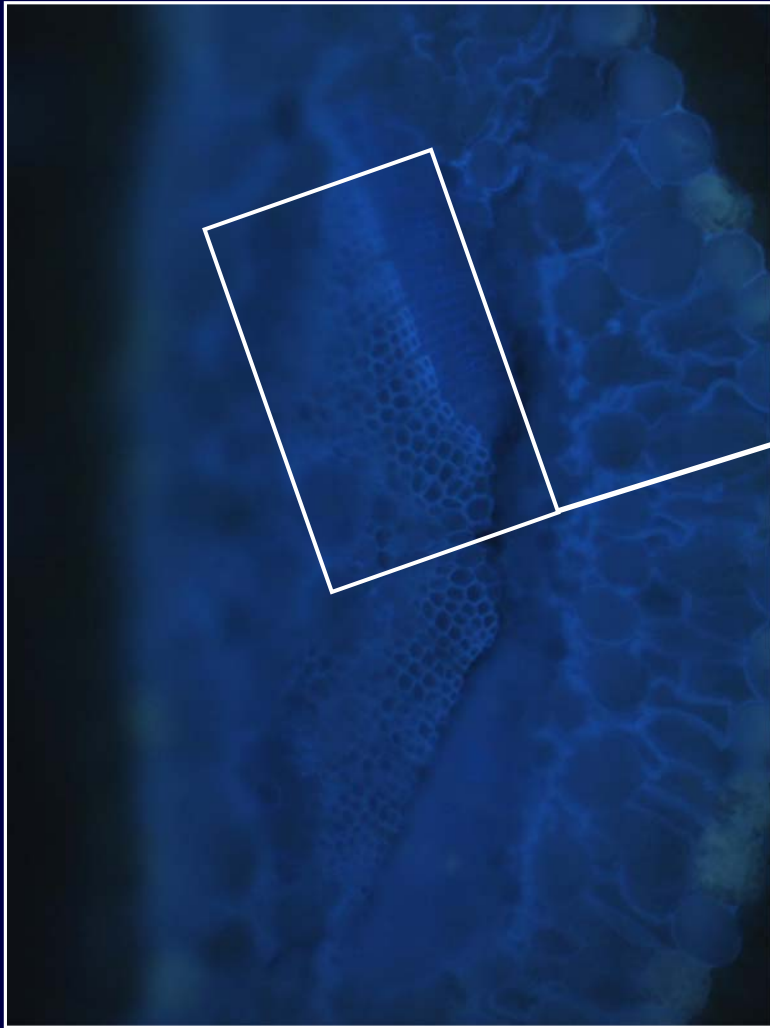

🌲 On fresh to dried needles:  
No observed collapse

## Capacitance

Time to recovery the loss of conductivity reached at -3,9MPa  
at -0,4MPa with cavitron

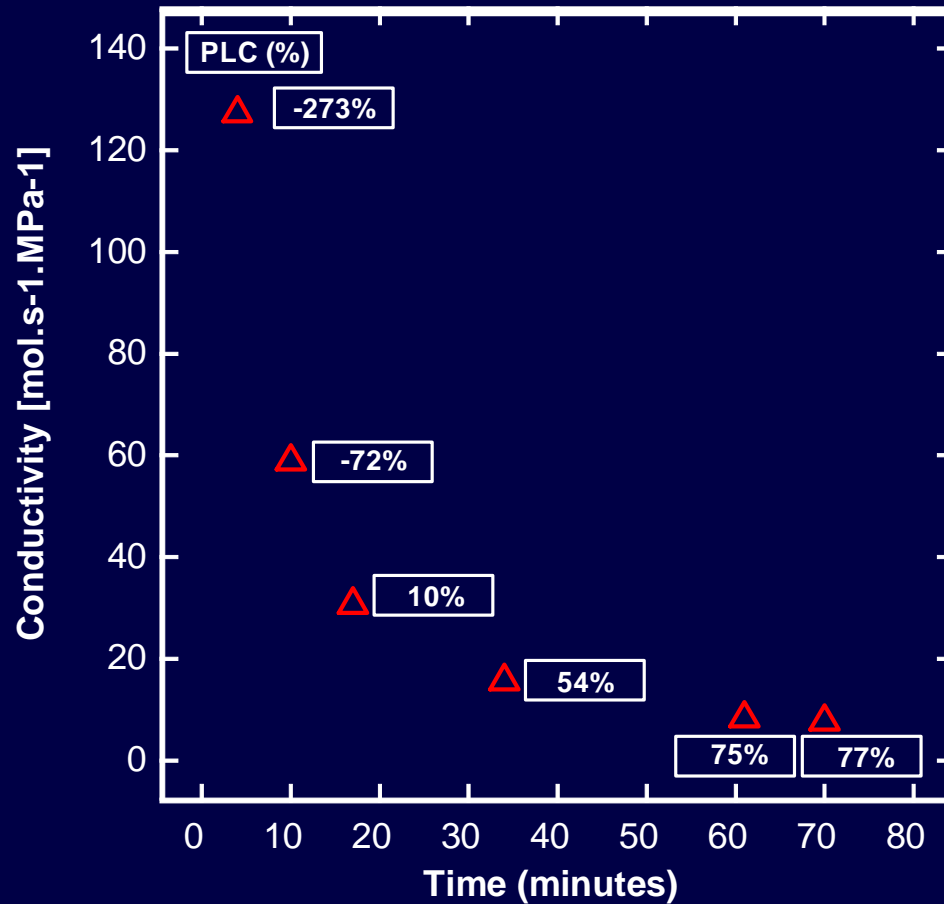

$\Psi$  max: -3,91MPa  
(80% PLC)

$\Psi$  measure: -0,43MPa





High capacitance in *Pinus pinaster* needles

## Capacitance

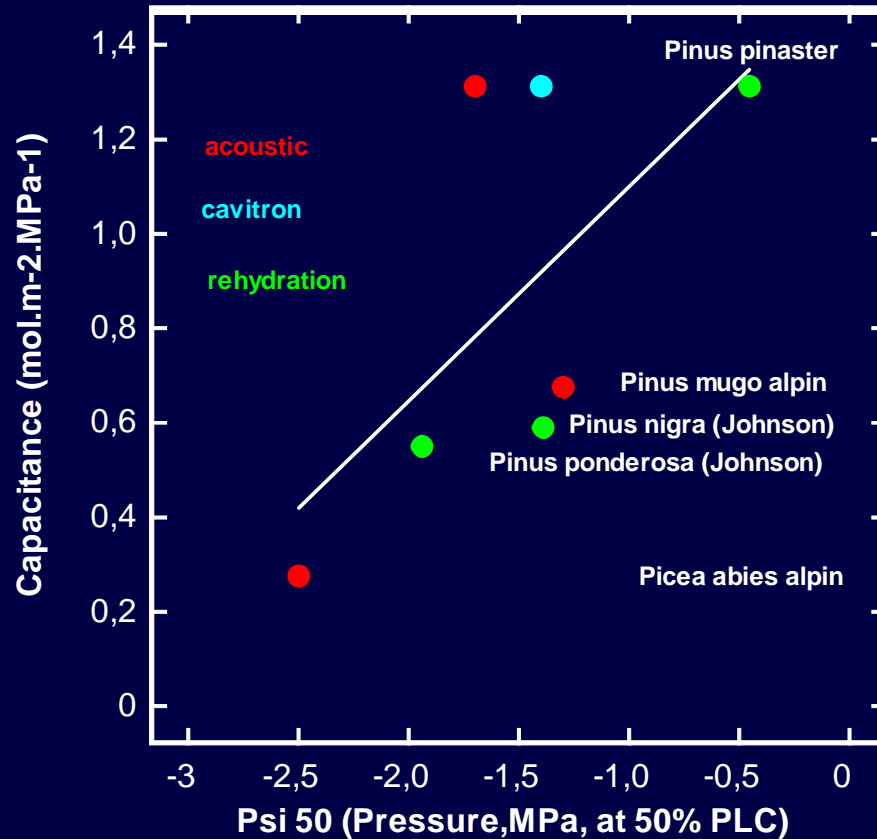
### Needles capacitance VS needles vulnerability (P50)



 Linear relation between  $\Psi_{50}$  and capacitance

 More vulnerable needles have a bigger capacitance

 *Pinus nigra* and *Pinus ponderosa* of „Johnson, 2009, PCE“

# Acknowledgments:

 Fonds zur Förderung der Wissenschaftlichen  
Forschung



 University of Innsbruck and Bordeaux  
Institute of Botany and UMR Biogeco



 Jean-Baptiste Lamy, Yann Guengant





Thanks !



# Miraculous xylem refilling in plants

**Hervé Cochard**

UMR PIAF

INRA, Clermont-Ferrand, France

# Previous paradigms

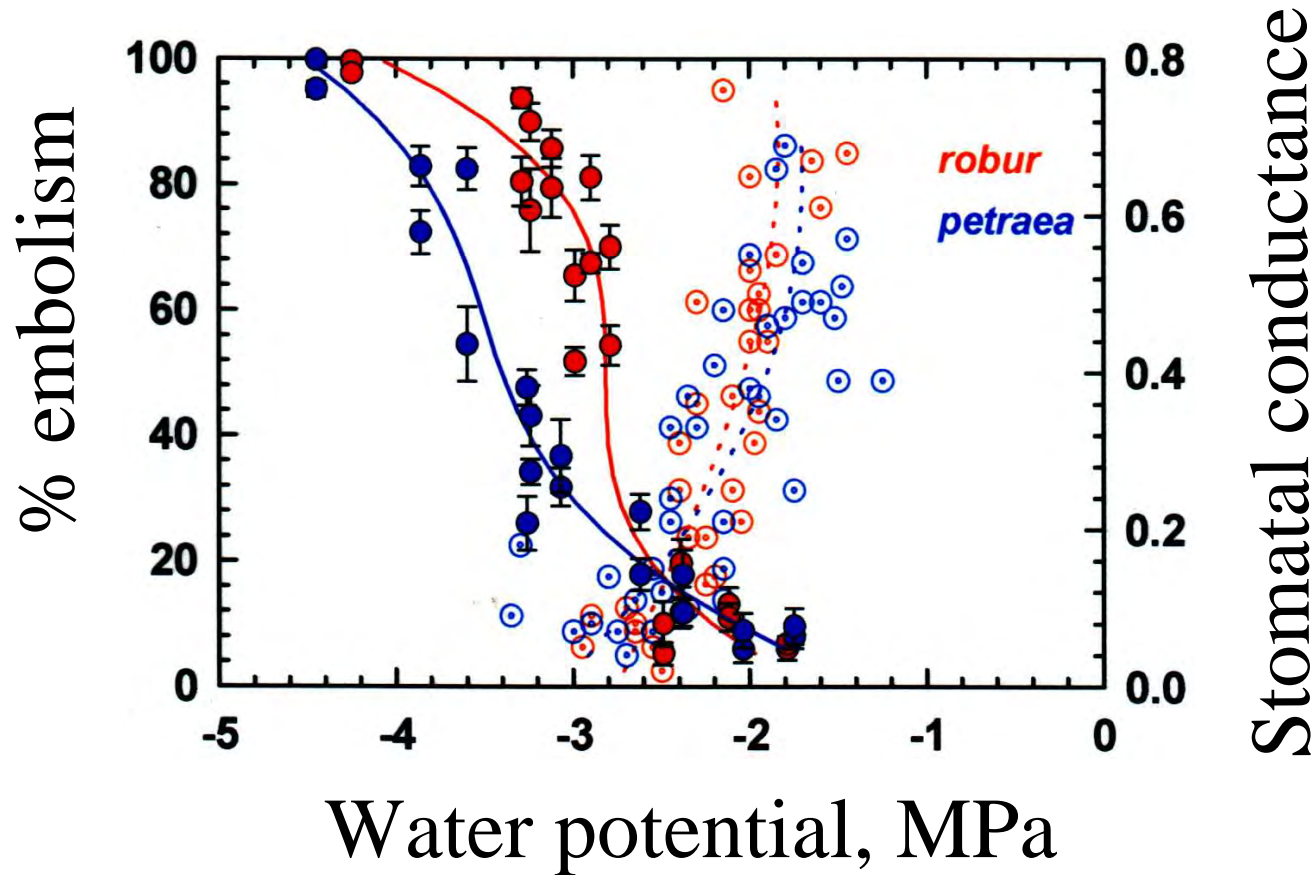

Plants operate near the point of xylem dysfunction

Stomatal closure prevents xylem embolism

# Previous paradigms

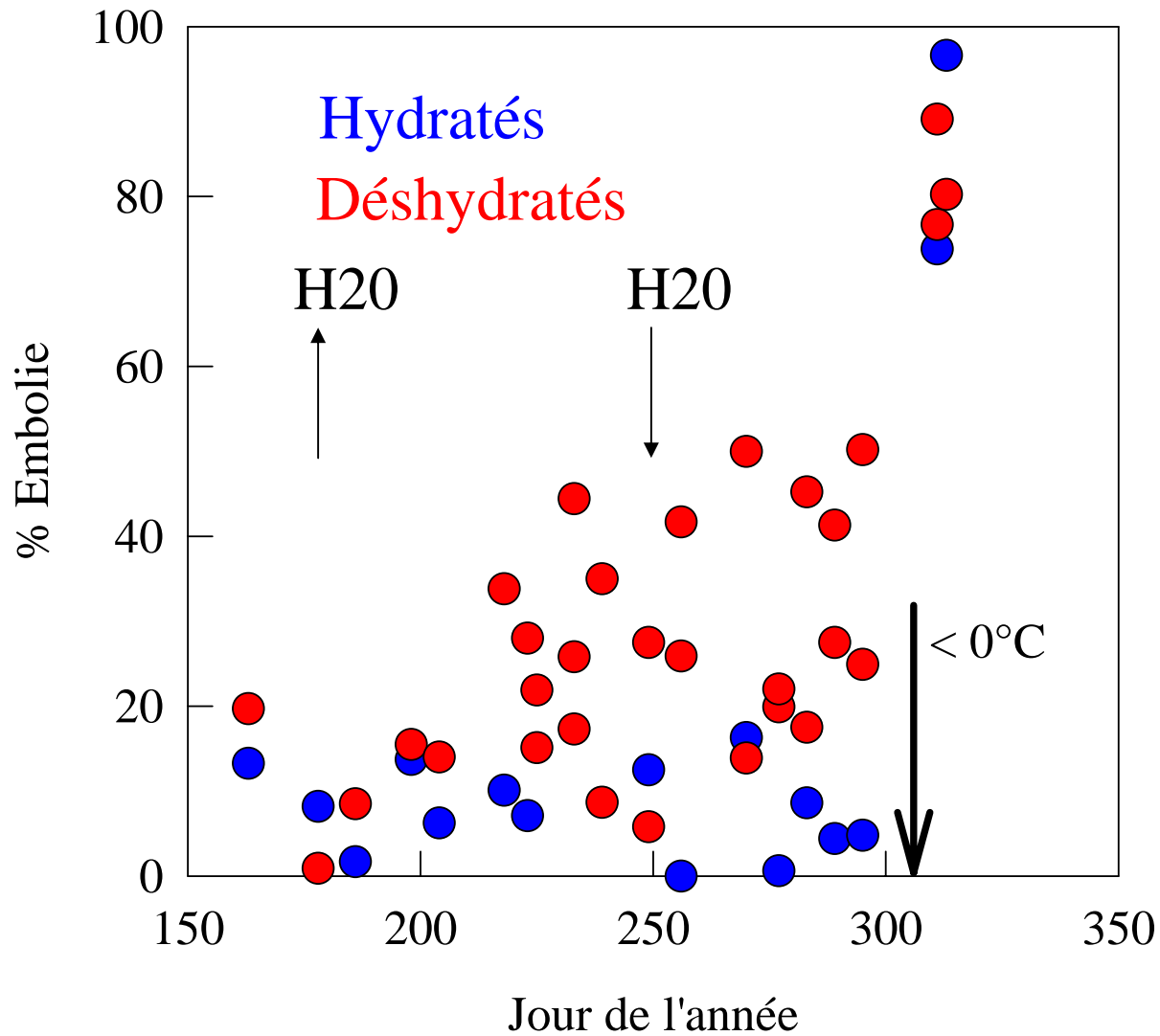

# How plants were able to recover from xylem embolism?

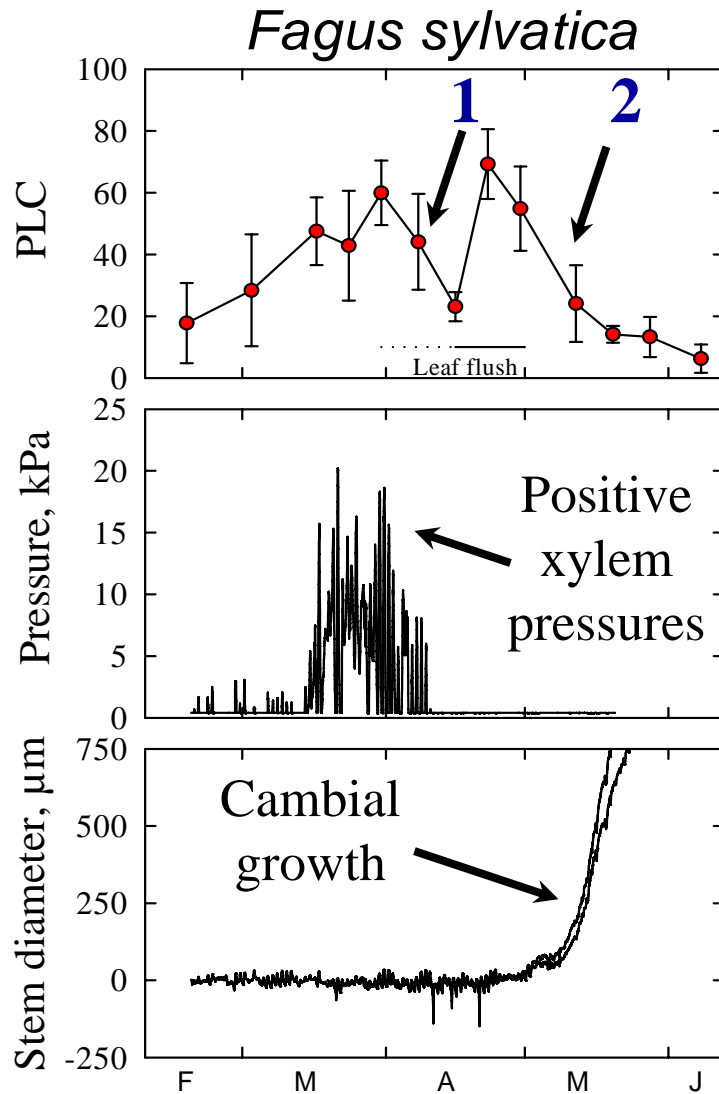

1- Xylem refilling

2- Xylem recovery

# Physics of xylem refilling

(Yang and Tyree 1992)

Air bubble at  
atmospheric  
pressure ( $P_{\text{gaz}}$ )

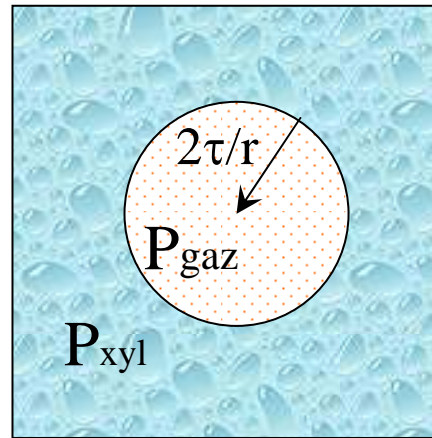

Xylem sap  
saturated with air  
at  $P_{\text{xyl}}$  pressure

For the bubble to collapse:

$$\mathbf{P_{xyl} > P_{gaz} - 2\tau/r}$$

If  $r = 30 \mu\text{m}$   $P_{\text{xyl}} > -5\text{kPa}$



No transpiration + root pressure to  
compensate gravitational forces

# Can xylem vessels refill if $P_{xyl} < - 2\tau/r$ ?

Many reports in the literature of refilling  
when  $P_{water} < - 2\tau/r$  and transpiration is high

Cryo-SEM : virtually all the studies

Acoustic technique : many reports

Hydraulic technique : more and more reports

# Evidence from the Cryo-SEM technique

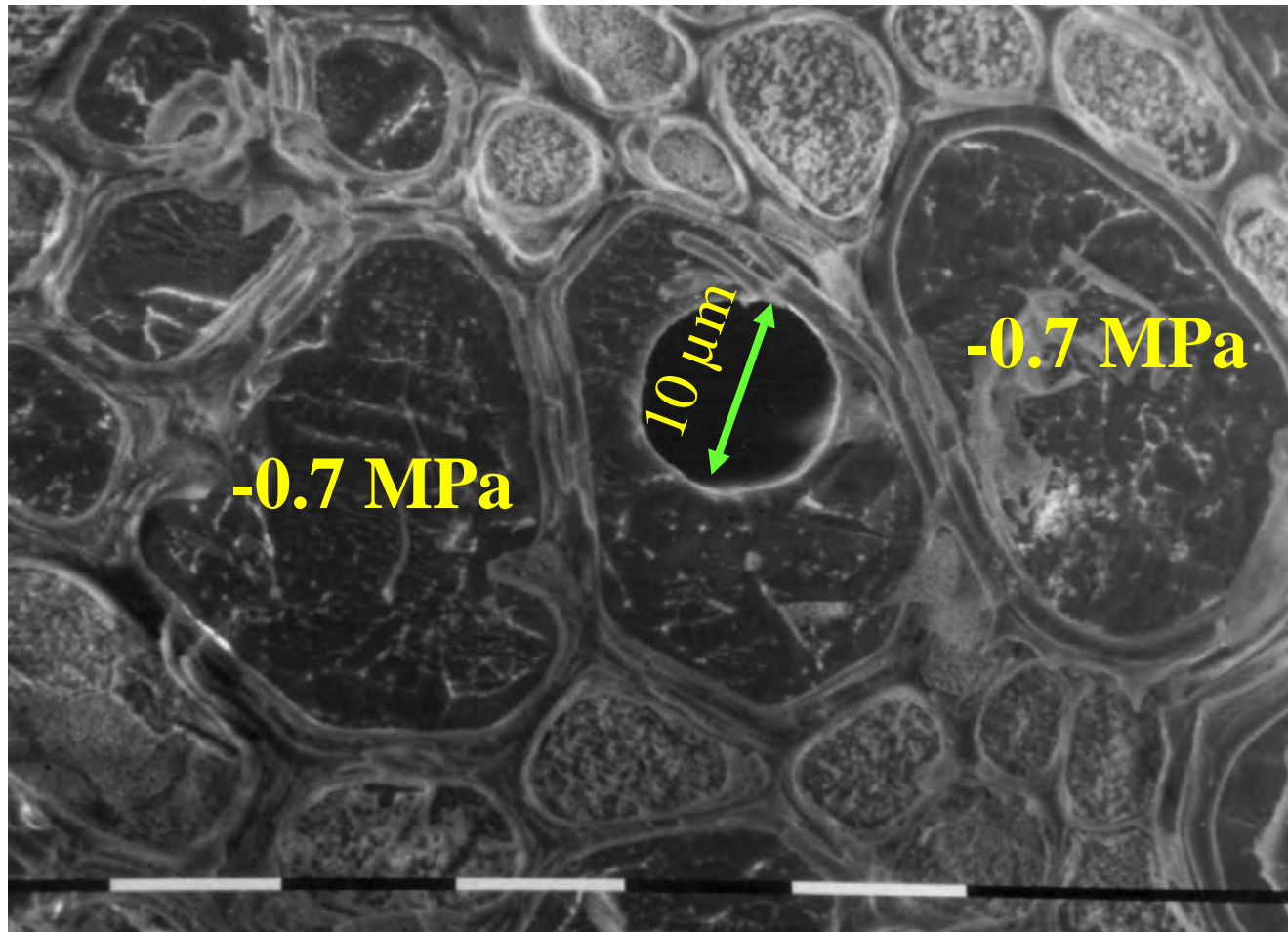

Refilling while  $P_{xy1} < 2\tau/r$  ?



# Diurnal trends of embolism in walnut petiole (Cochard et al 2000)

**Cryo-SEM** ●

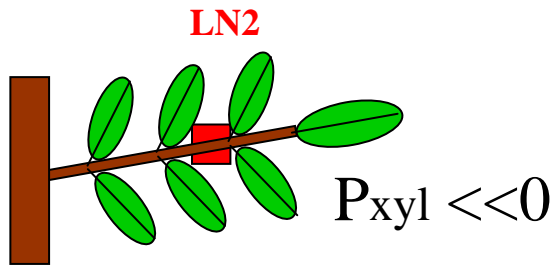

**Cryo-SEM**  
+  $P_x = 0$  ●

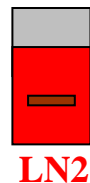
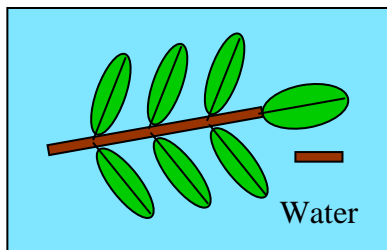

$P_{xyl} = 0$

**Hydraulic** ■

Freezing artifact when  $P_{xyl} < 0$

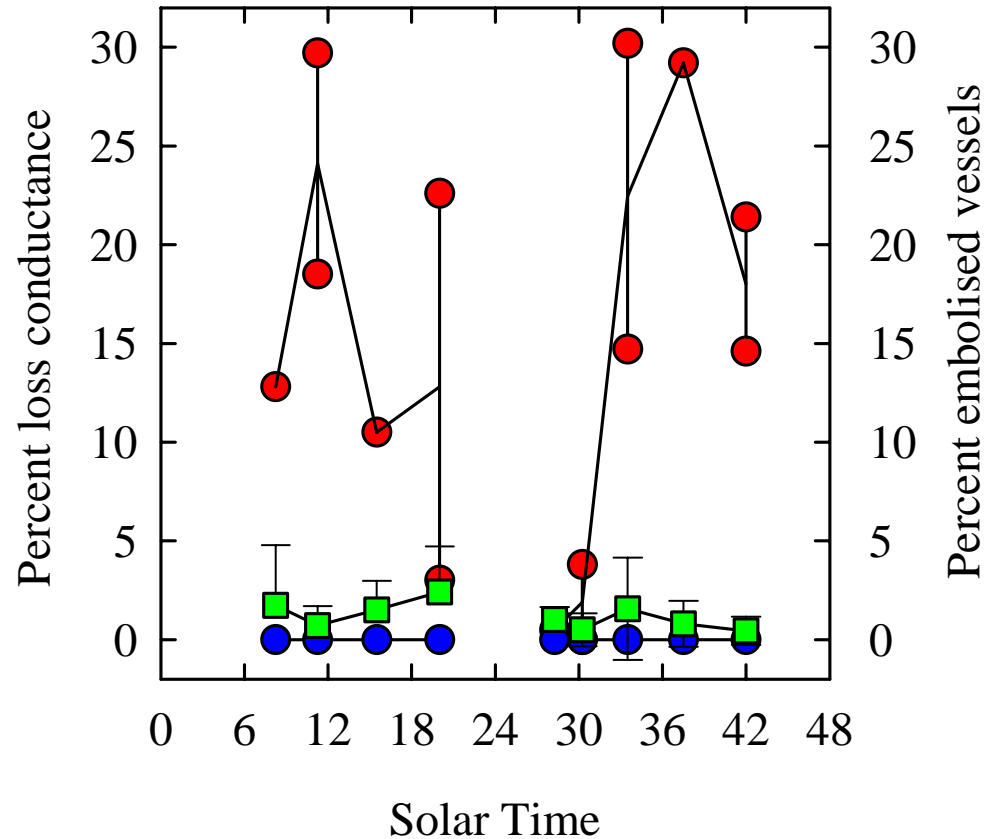

# Evidence for xylem refilling while $P_{xyl} < - 2\tau/r$ ?

Vitis (Salleo et al 1989, Brodersen et al 2010, Zufferey et al 2011)

Laurus (Salleo et al 1996, Tyree et al 1999, etc...)

Pinus (Edwards et al 1994)

Zea (McCully et al 1998)

Fraxinus (Zwieniecki et al 1998)

Acer (Zwieniecki et al 1998)

Picea (Zwieniecki et al 1998)

Helianthus (Nardini et al 2008)

Oryza (Stillet et al 2005)

Populus (Secchi et al 2010)

...

What is this novel mechanism?

“Do we need a new paradigm?” (Tyree et al 1999)

“Do we need a miracle?” (Holbrook and Zwieniecki 1999)

$$P_{\text{xyl}} > P_{\text{gaz}} - 2\tau/r$$

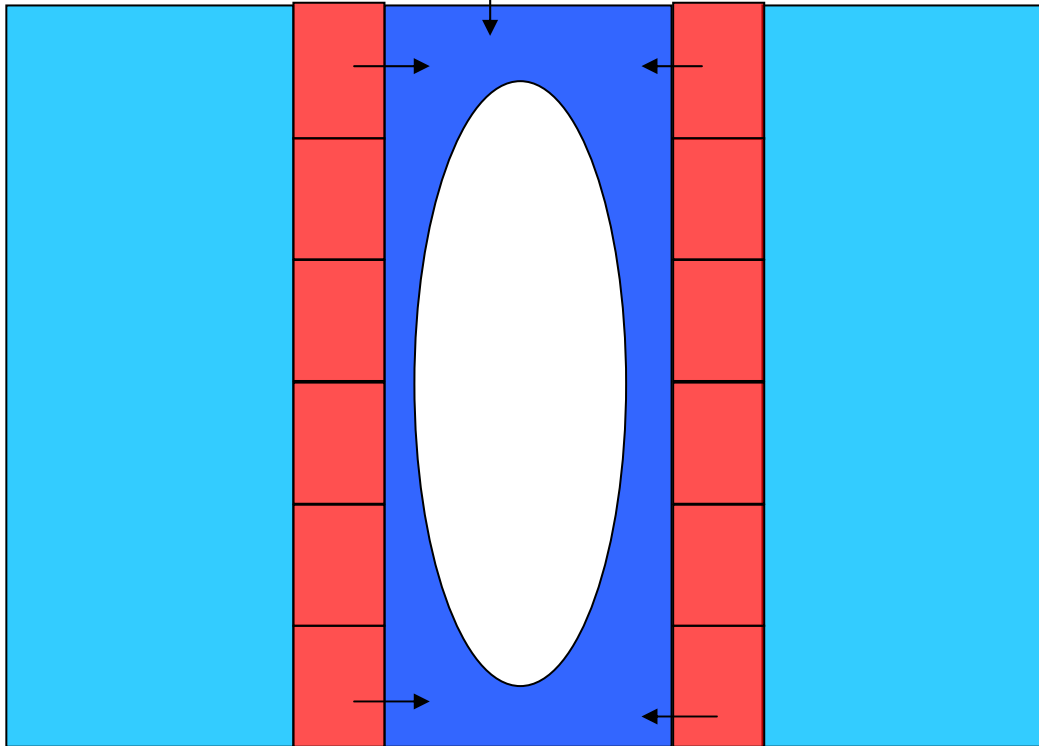

Hydraulic isolation ?

Driving force for water flow ?

# Hypotheses for a “novel” refilling mechanism

## The “large organic solute” hypothesis

(Hacke & Sperry 2003)

Large organic solute  
flow into the vessel  
causing a water flow  
and the refilling

Pit membrane acts as  
an osmotic membrane

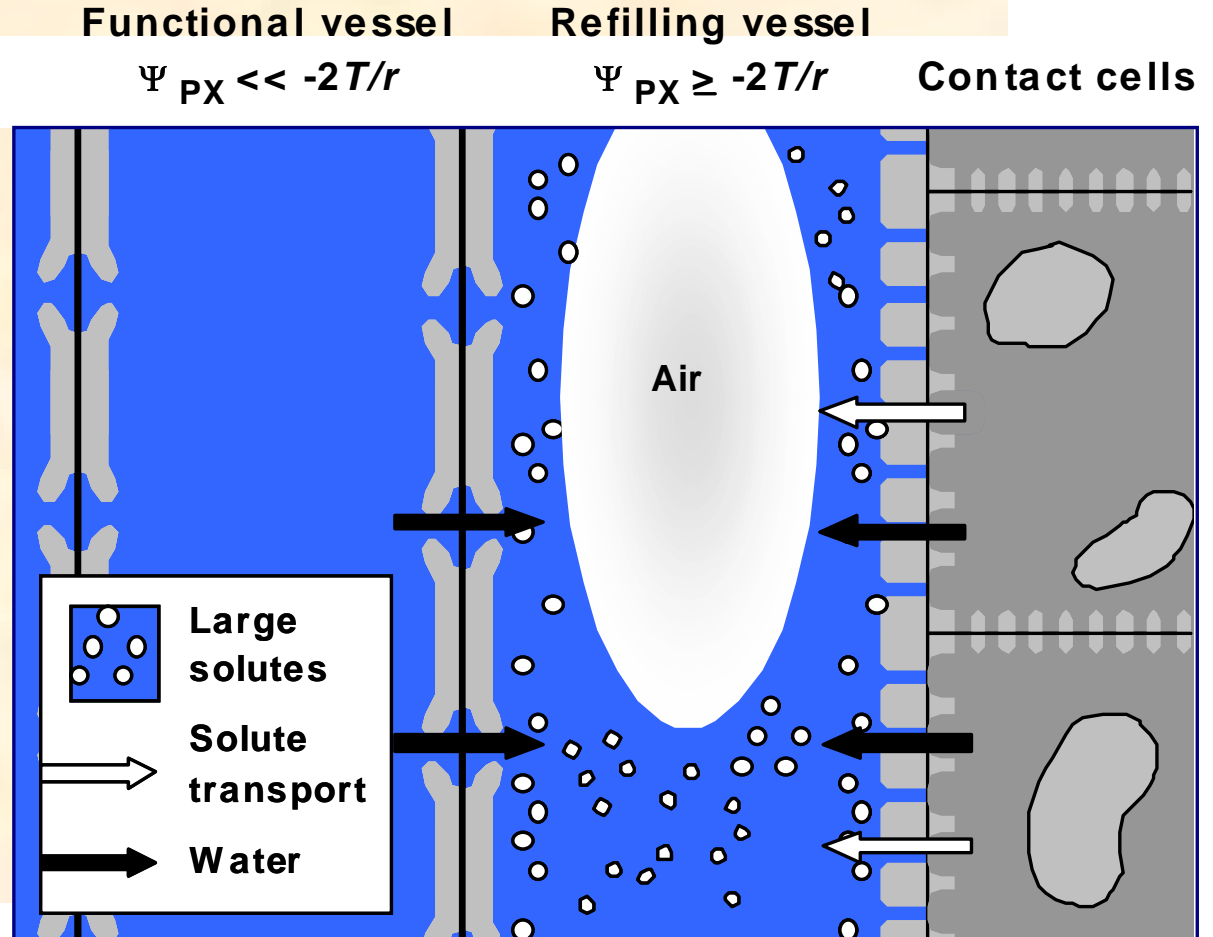

# Hypotheses for a “novel” refilling mechanism

## The “pit valve” hypothesis (Holbrook & Zwieniecki 1999)

Solute flow into the vessel causing a water flow and the refilling

Embolised vessels have to be hydraulically isolated

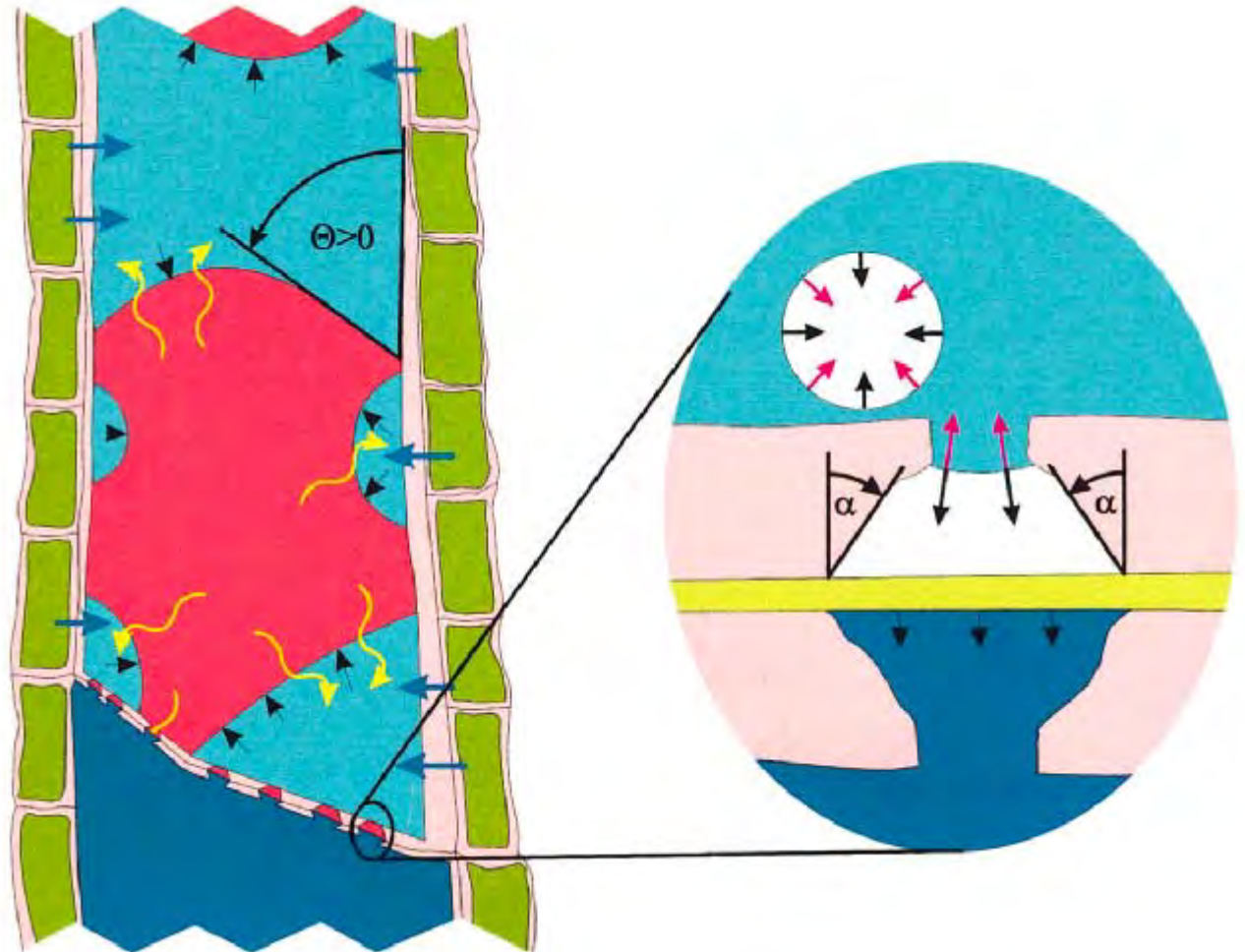

# More insights into this “novel” refilling mechanism

Phloeme is important (girdling exp) Salleo et al 2003, Bucchi et al 2003

Starch and sucrose is implicated in the mechanism : Salleo et al 2006

Requires energy (Proton pump) Salleo et al 2004

Aquaporins are implicated Sakr et al 2003, Secchi & Zwieniecki 2010

Sensing and triggering the refilling

- Wall vibration Salleo et al 2008

- Chemical sensing (Zwieniecki and Holbrook 2009)







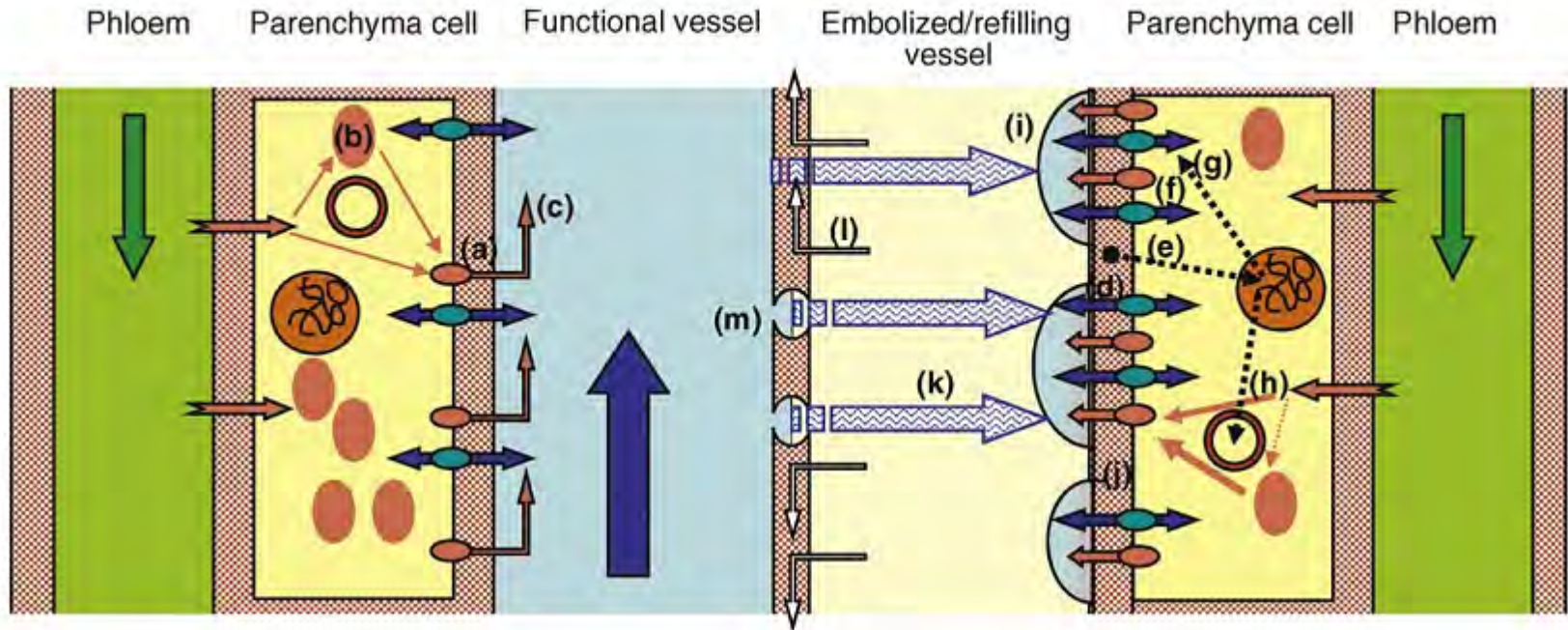



- Simulations Vesela et al 2003 Gas convection not diffusion

- Water condensation instead of liquid water flow (Zwieniecki and Holbrook 2009)

- New technologies (RMN, Tomography)



**Key:**

 Nucleus	 Sugar metabolic activity	 Liquid water flow
 Starch	 Sugar flow	 Water vapor flow
 Membrane sugar transporter	 Membrane water channel	 Air transport path
 Signaling paths	<b>a-m</b> Major points of interest (see figure legend for details)	

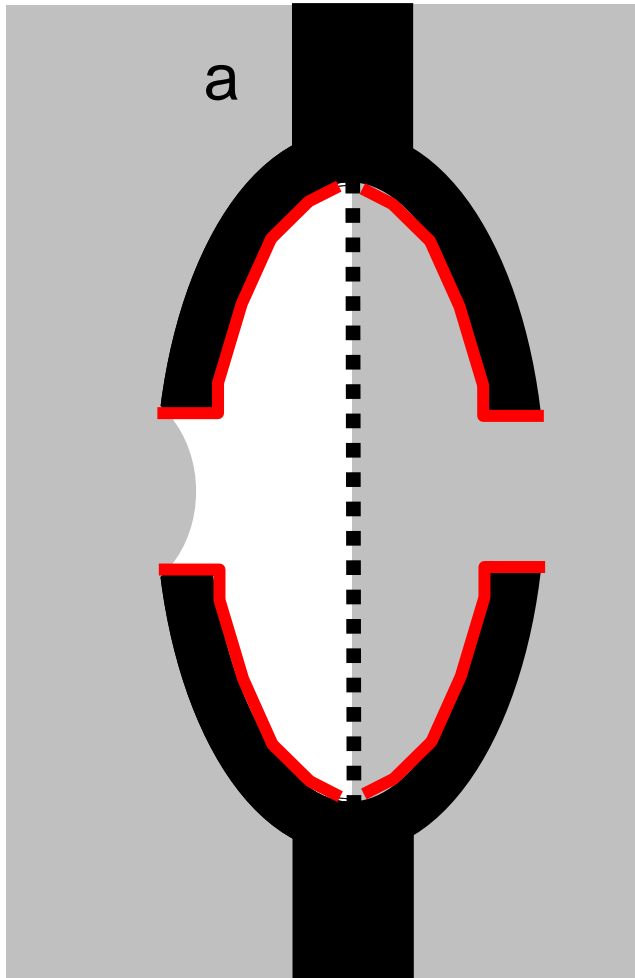

— Hydrophobic layer (lignin?)

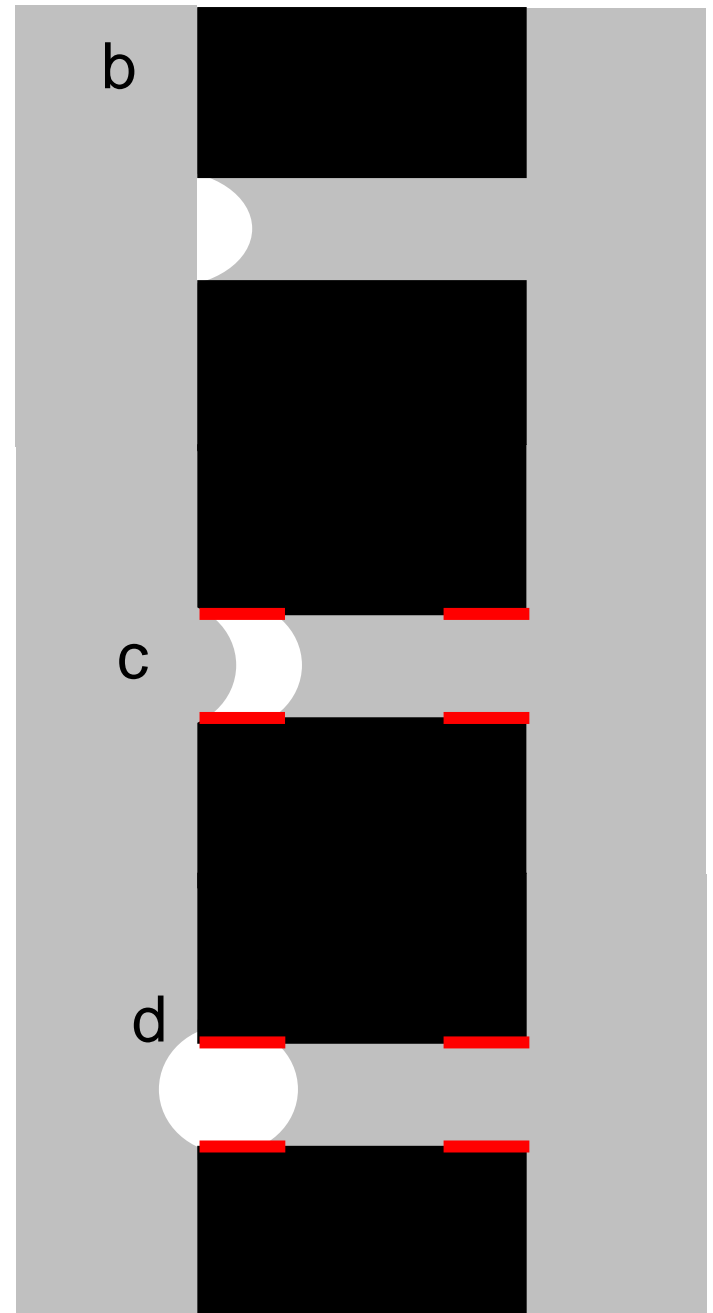



# Conclusions

‘Miraculous’ refilling seems to exist

Less and less miraculous

More explicitly included in our experiments

## New paradigms

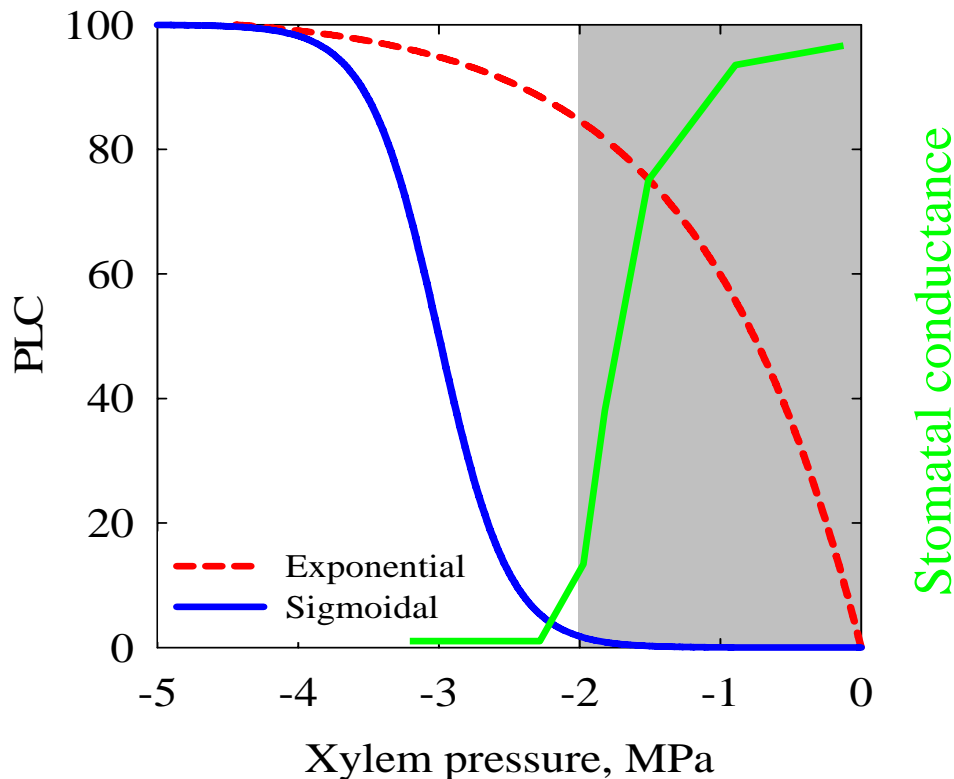

How generic?

Mechanisms ?

Functional benefit ?

(cost vs gain)

# What's new at Bordeaux?



## Taxonomic diversity of conifers and species measured for cavitation resistance

	Genera	species	Sampled species	Remaining sp.	sampled genera
Araucariaceae	3	41	3	38	1
Cephalotaxaceae	1	11	3	8	1
Cupressaceae	30	133	32	101	13
Phyllocladaceae	1	4	1	3	1
Pinaceae	11	228	34	194	7
Podocarpaceae	18	186	10	176	0
Sciadopityaceae	1	1	1	0	1
Taxaceae	5	23	6	17	2
<b>Total</b>	<b>70</b>	<b>627</b>	<b>90</b>	<b>537</b>	<b>26</b>

# Cavitation resistance of 100 conifer species



High variability of P50  
 from 2.1 (*Agathis*)  
 to 16 MPa (*Callitris collu*)

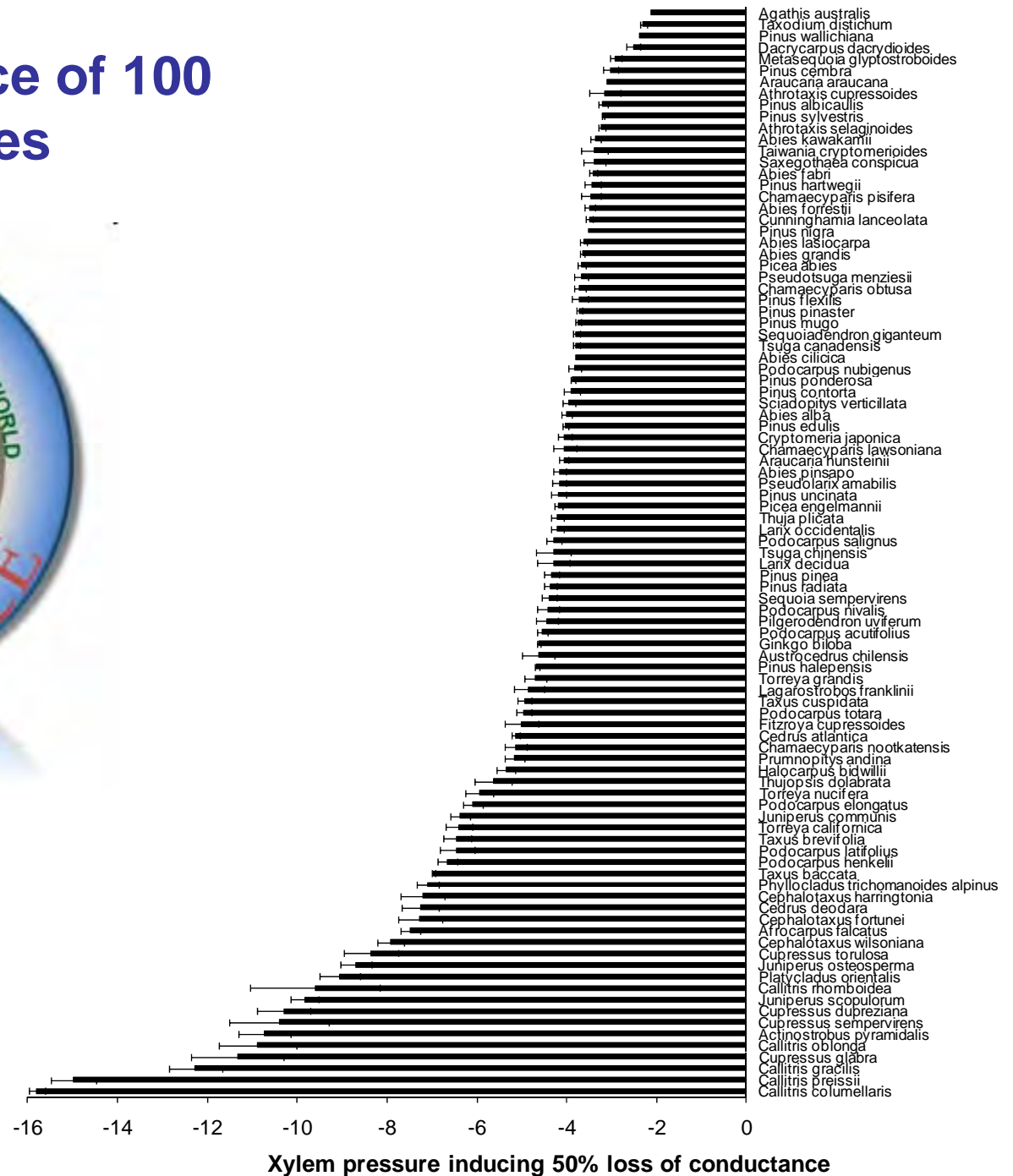

# Different levels of variation in cavitation resistance

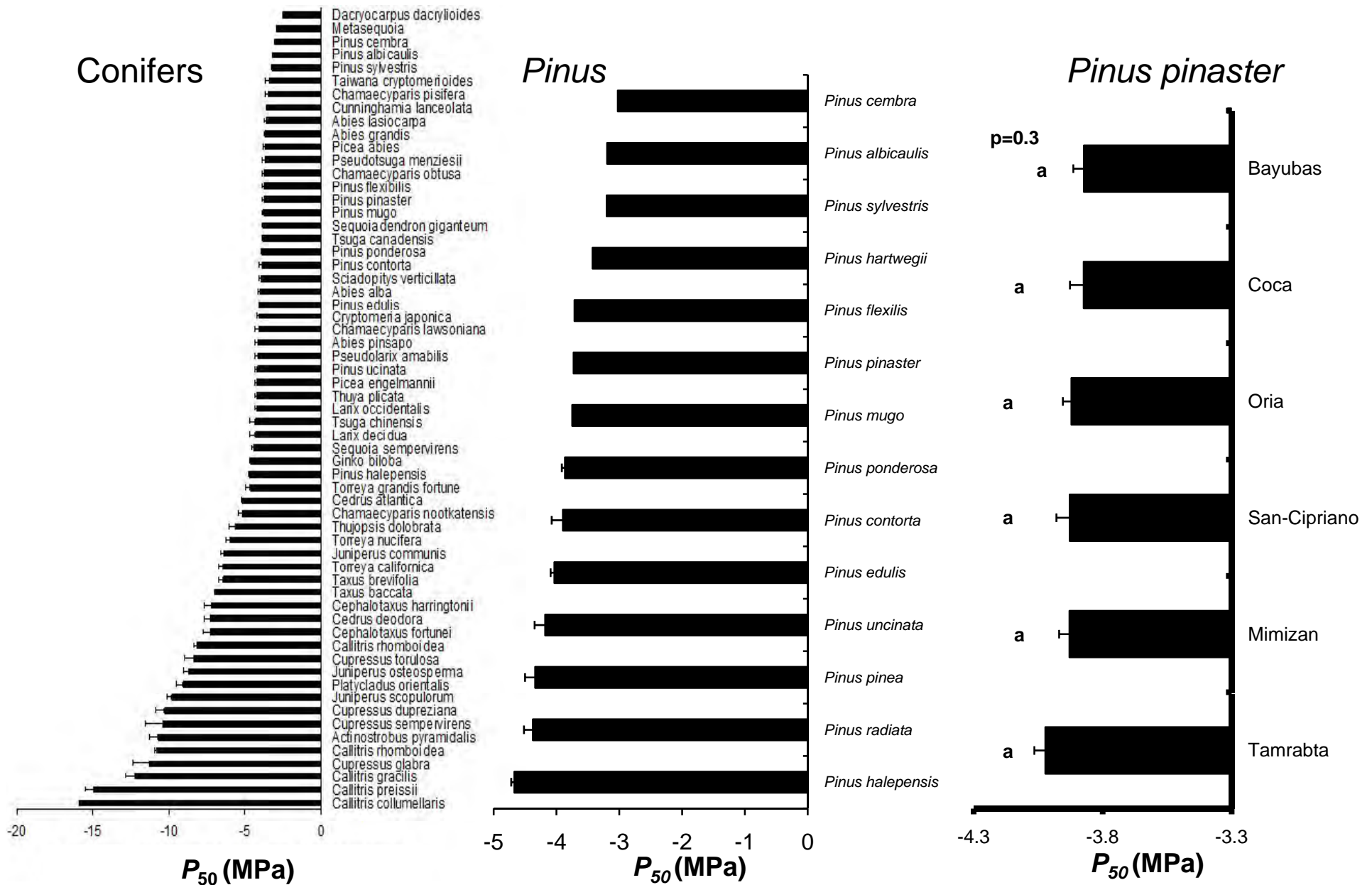

Delzon et al., PCE, 2010

Lamy et al., submitted, PLoS ONE

# Objectives

1. Extend the existing database for P50 and other traits (wood density, anatomy)
  2. Construct a phylogeny of conifers, using online sequence databases (NCBI)
  3. Test for evolutionary convergence versus evolutionary conservatism
- Correlate P50 with other measured traits.

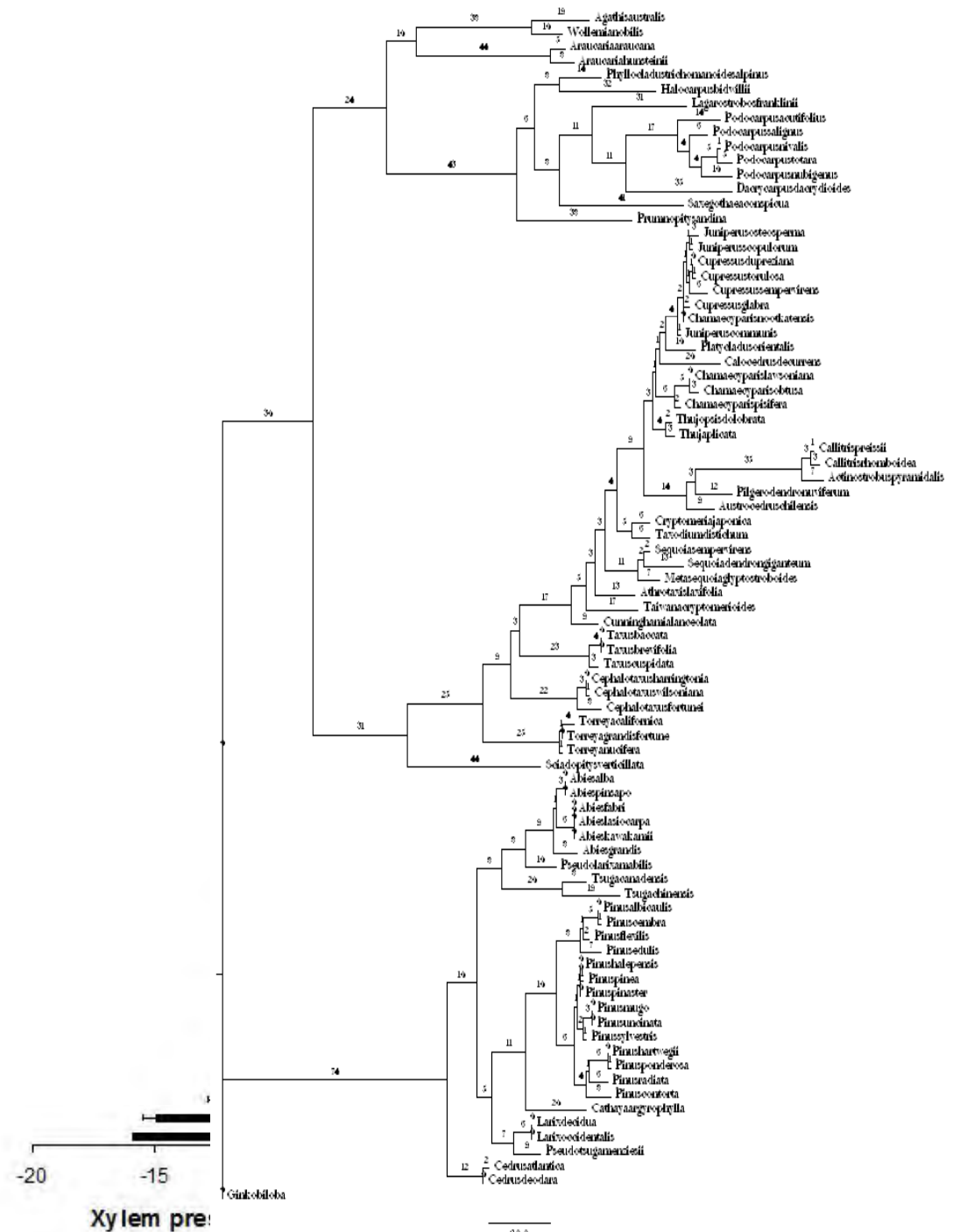

# Height-related effects on cavitation resistance in maritime pine trees

Sylvain Delzon, Mélanie Lucas, Régis Burlett, Hervé Cochard



*Eucalyptus regnans* measured at 132.6 m in 1872  
near Watts river, Victoria, Australia

It has long been believed that senescence is an inevitable consequence of ageing in all plants and animals.

**old animal**



**old trees**



# How to test the hydraulic limitation hypothesis ?

$$F = K_L * \Delta\Psi$$

• **small tree**  
.....

VPD = 3kPa

$g_s = 100$

$F = 0.7$

$\Psi_{Lmin} = -4$

$\Delta\Psi = -3.5$

$\Psi_{soil} = -0.5$

$K_L = 0.2$



• **tall tree**  
.....

VPD = 3kPa

$F = 0.35$

$\Psi_{Lmin} = -7.5$

$\Delta\Psi = -7.0$

$\Psi_{soil} = -0.5$

$K_L = 0.1$



Transpiration decrease

homeostasis

$g_s = 50$





# Leaf-specific hydraulic conductance

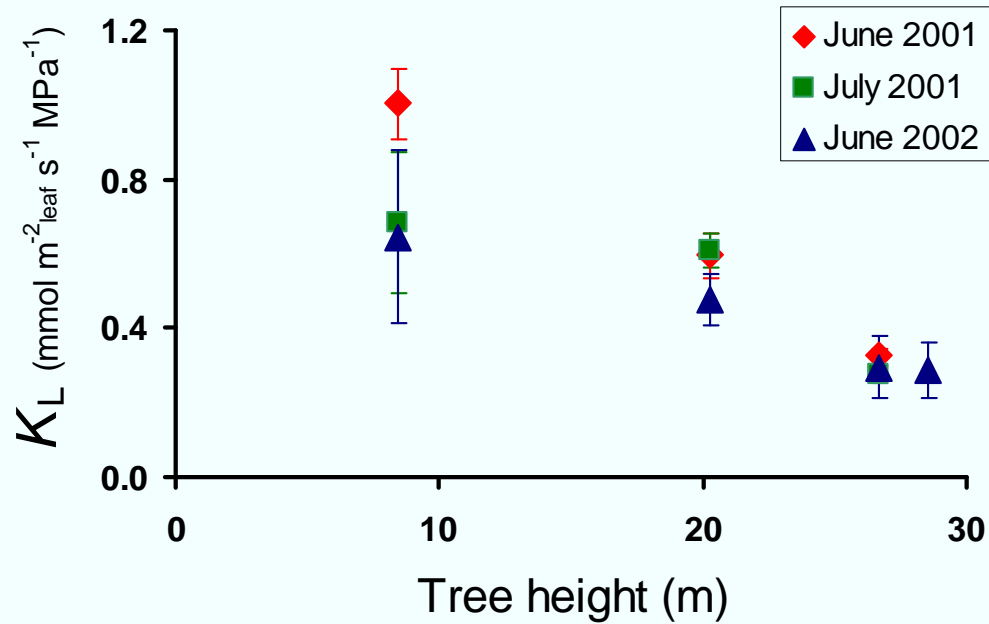

Leaf-specific hydraulic conductance ( $K_L$ ) versus tree height



Substantial decrease in hydraulic conductance with increasing tree height

# Which hydraulic compensation mechanisms occur?

- ✓ hydraulic adjustment: decrease in leaf to sapwood ratio ( $A_L:A_S$ )
- ✓ increase in soil to leaf water potential gradient (decrease in minimum leaf water potential ( $\Psi_m$ ))
- ✓ production of xylem tracheids with increased permeability (higher sapwood-specific hydraulic conductivity ( $k_S$ ))
- ✓ increased water storage in the stem

# Compensation mechanisms

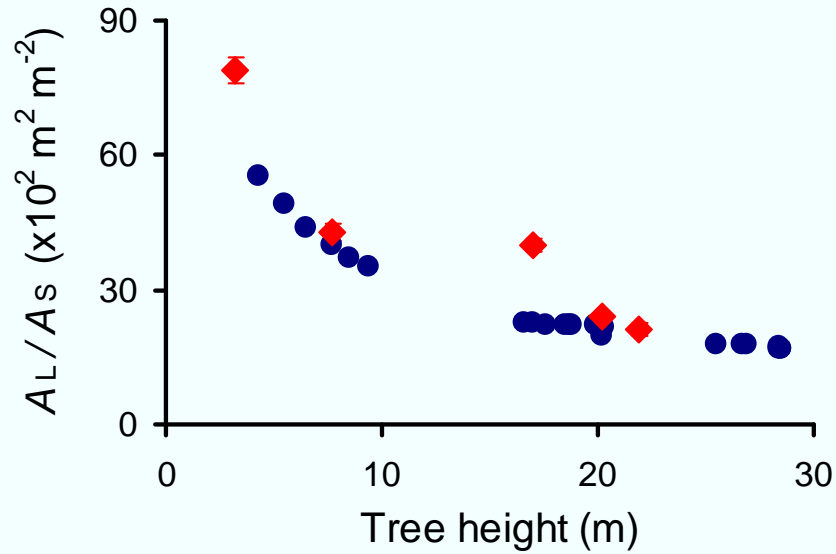

Leaf / sapwood area ratio versus tree height

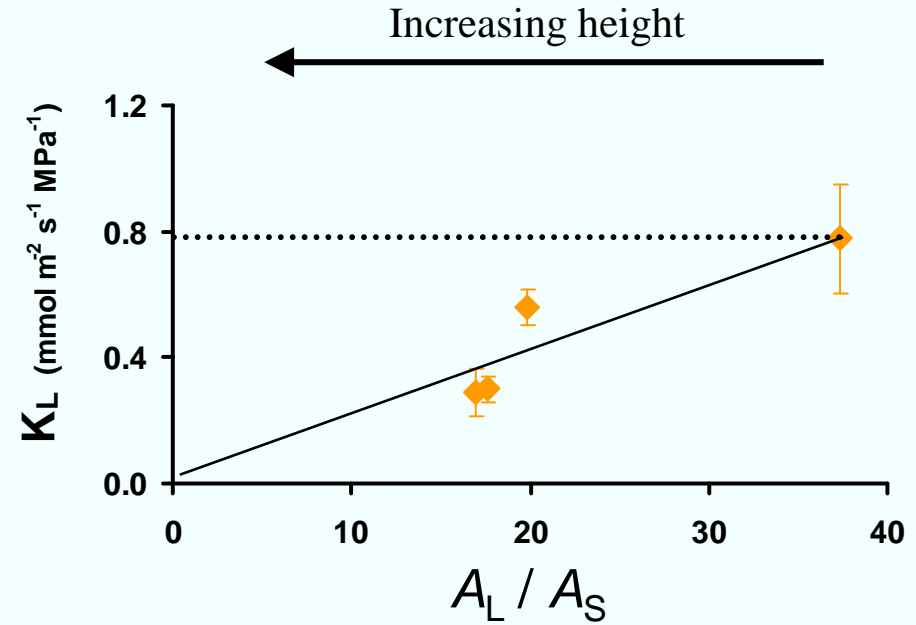

Leaf-specific hydraulic conductance versus leaf / sapwood area ratio

➔ Hydraulic compensation  
(decrease in  $A_L : A_S$ )

➔ Compensation is  
incomplete

# Consequence for stomatal conductance

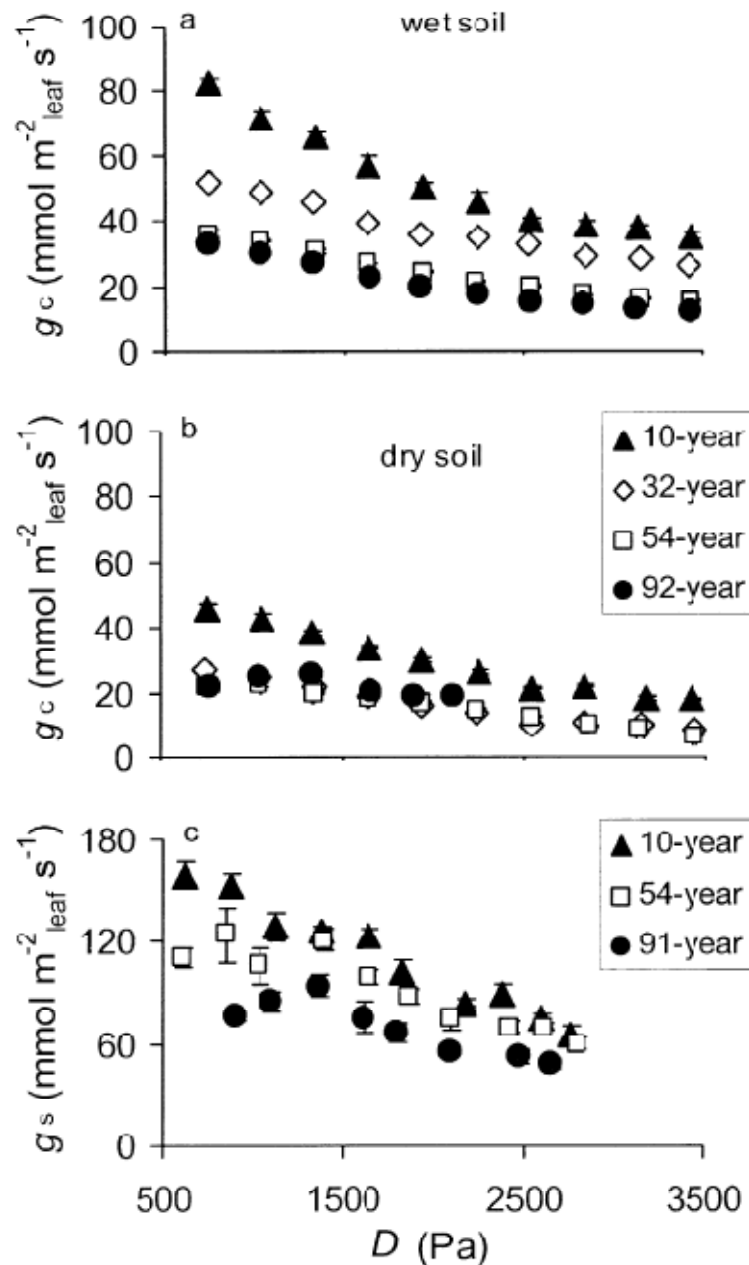

Stomatal conductance versus air vapor pressure deficit (VPD)

- Stomatal closure allows to maintain minimum water potential above the critical threshold in tall trees
- Decrease in stomatal conductance induces both transpiration and assimilation declines

*Delzon et al. 2004 PCE*

# Summing up

$$g_s = \frac{1}{h} \frac{1}{\underbrace{A_L / A_S}_{\text{cst ?}}} \frac{\underbrace{\Delta \Psi}_{\text{cst ?}}}{\underbrace{VPD}_{\text{cst ?}}}$$

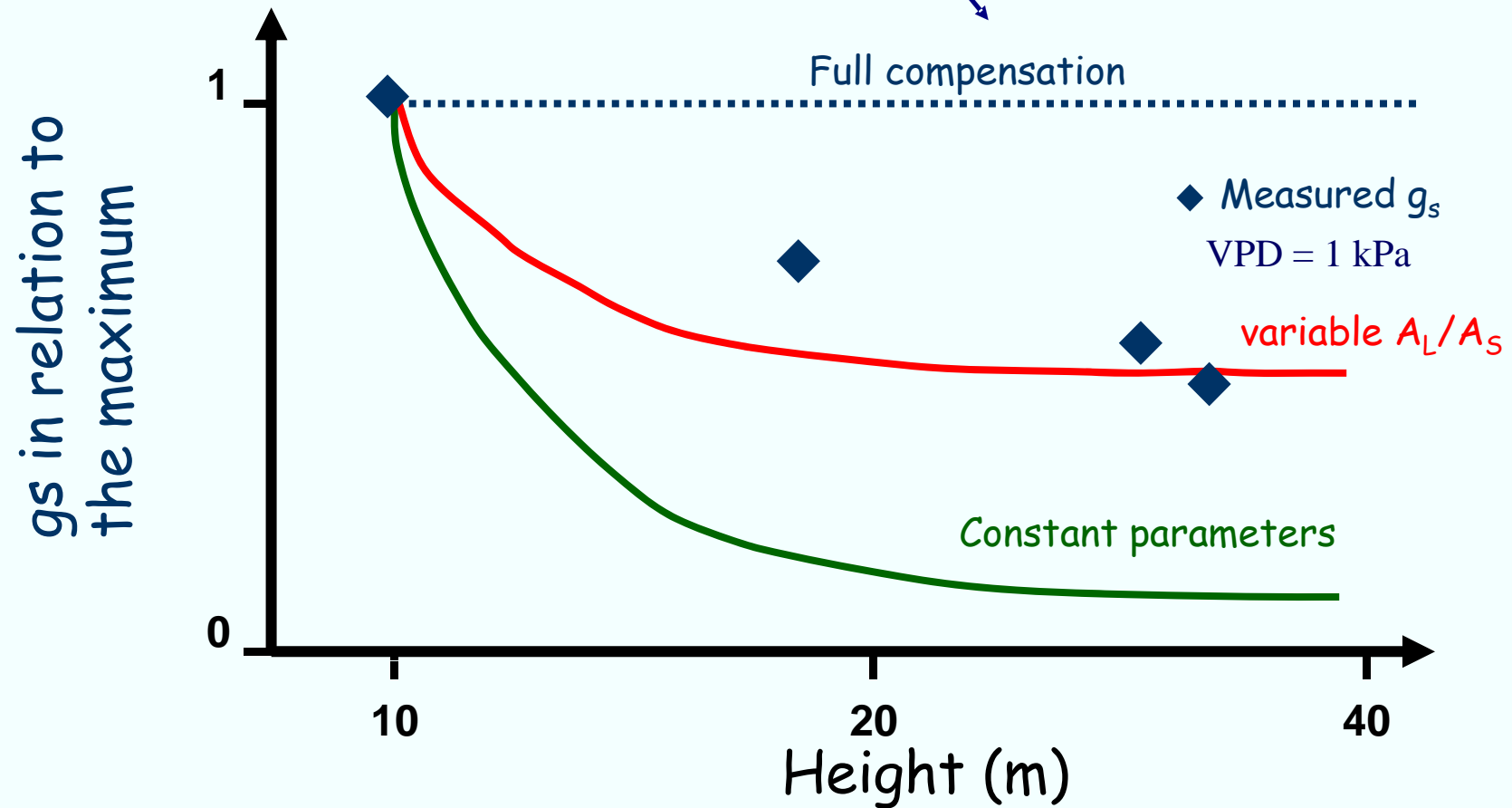

# Homeostasis in maritime pine tree ?

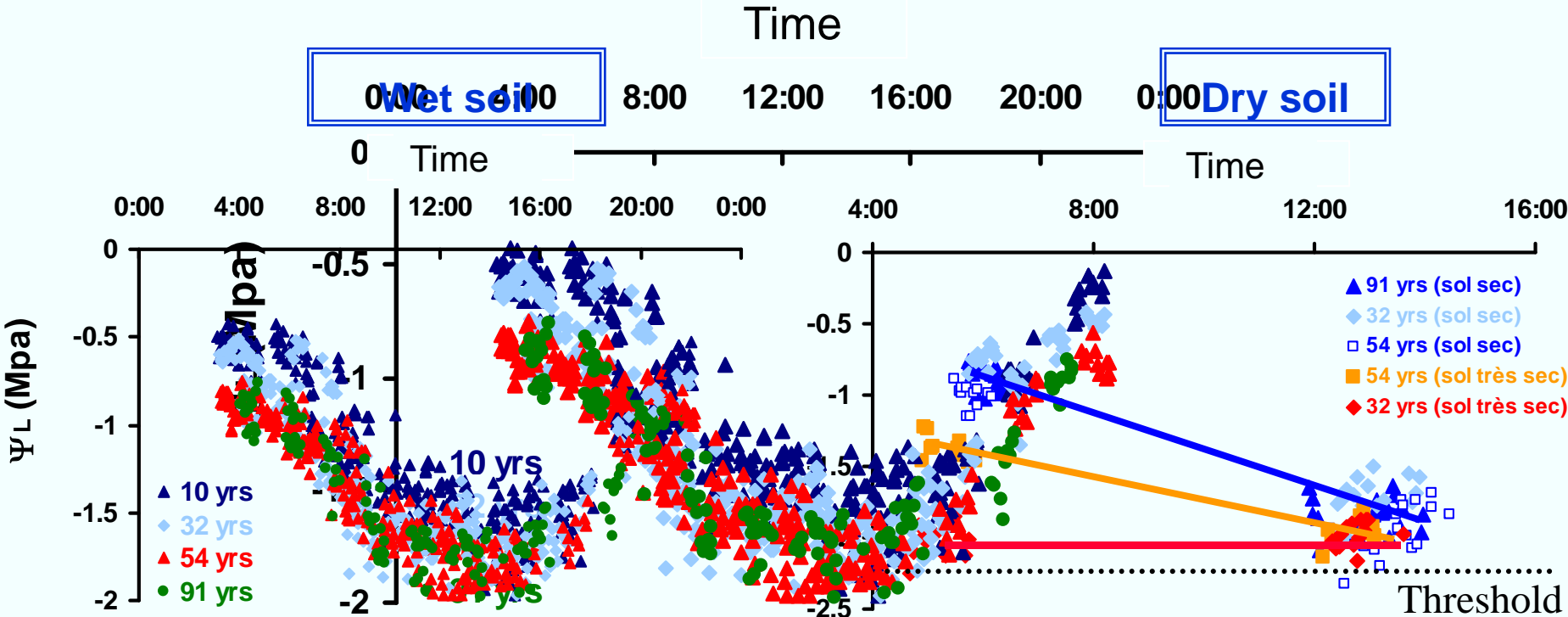

Needle water potential measurements carried out across the chronosequence

➔ Threshold values about -2 MPa

# Relationship between cavitation resistance and minimum water potential

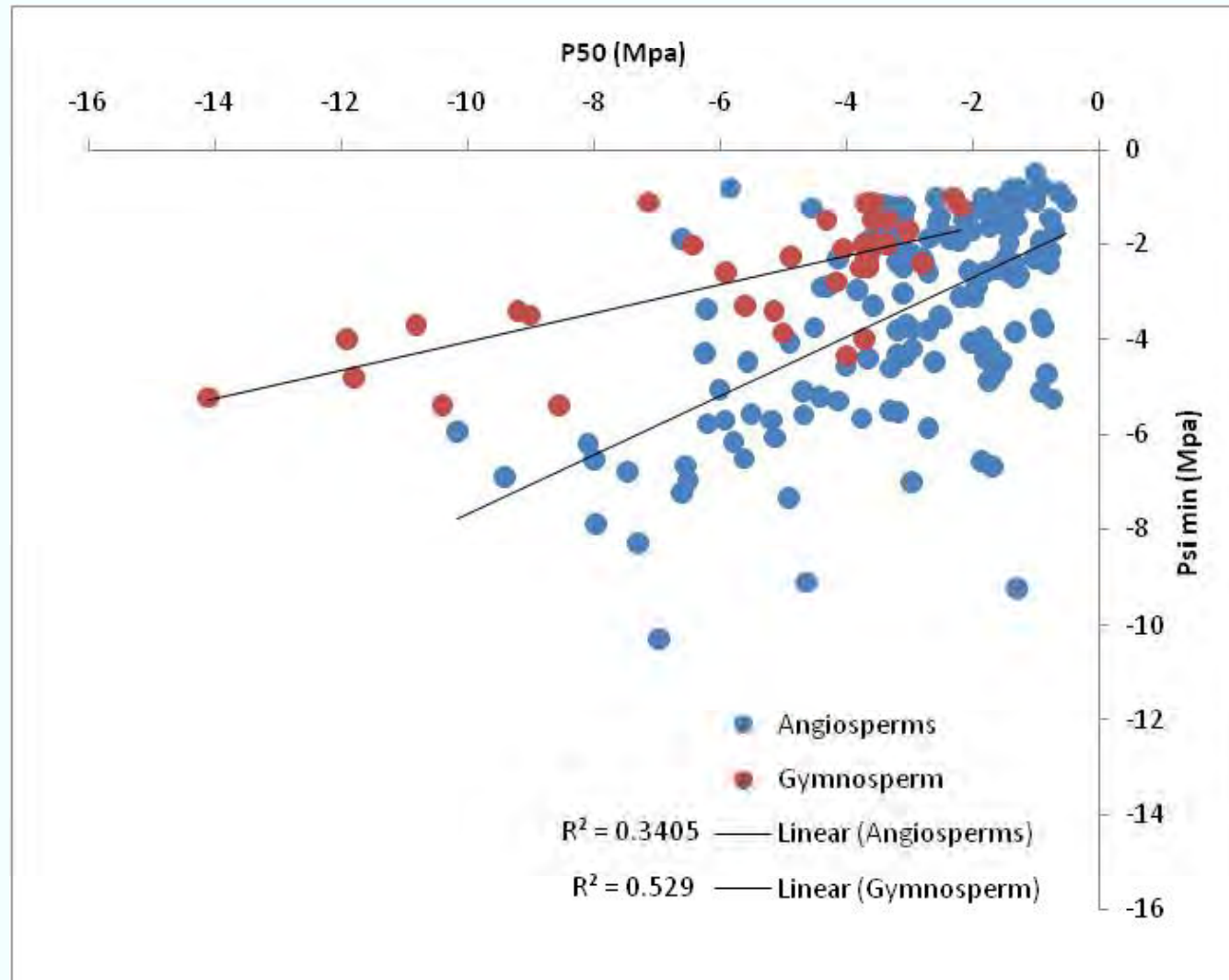

Do cavitation resistance (safety) and specific hydraulic conductivity (efficiency) remain constant with increasing tree height?



# Maritime pine chronosequence

## 12 even-aged stands

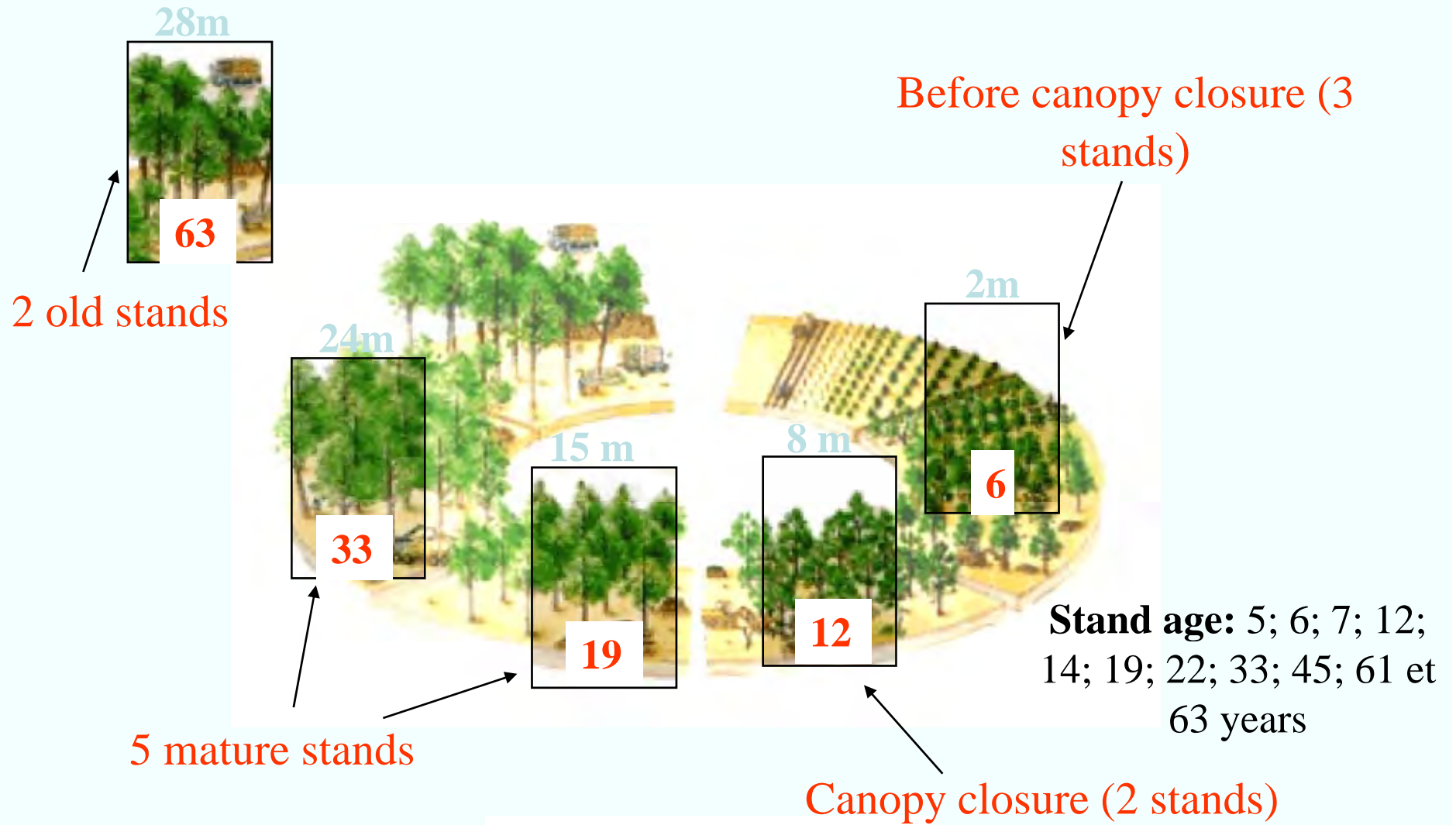

# Vulnerability curves

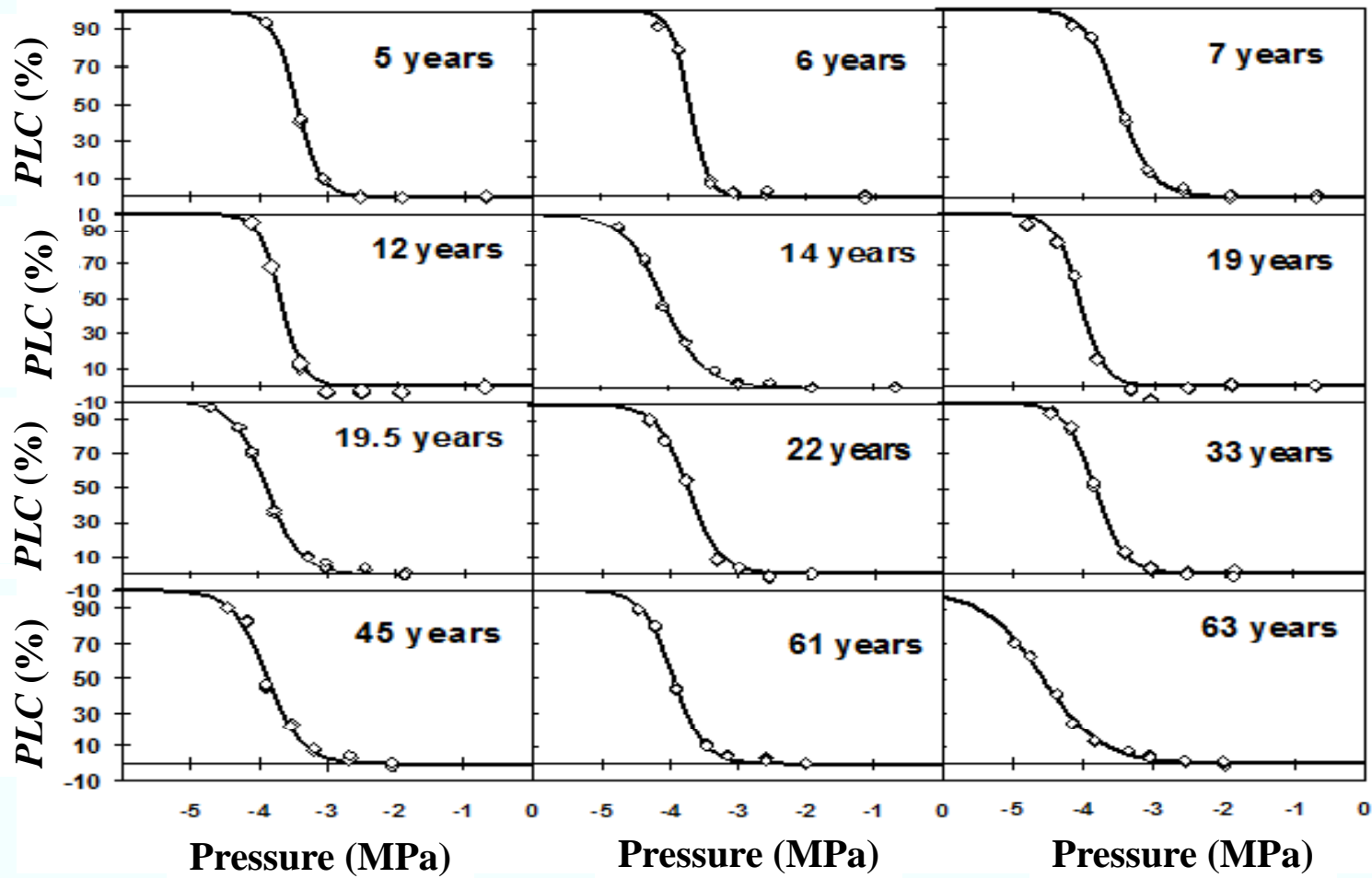

# Evolution of cavitation resistance

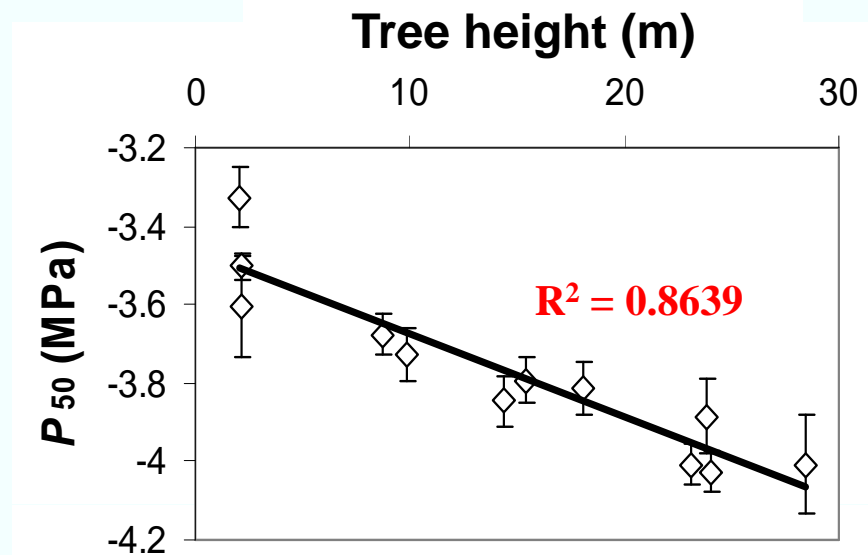
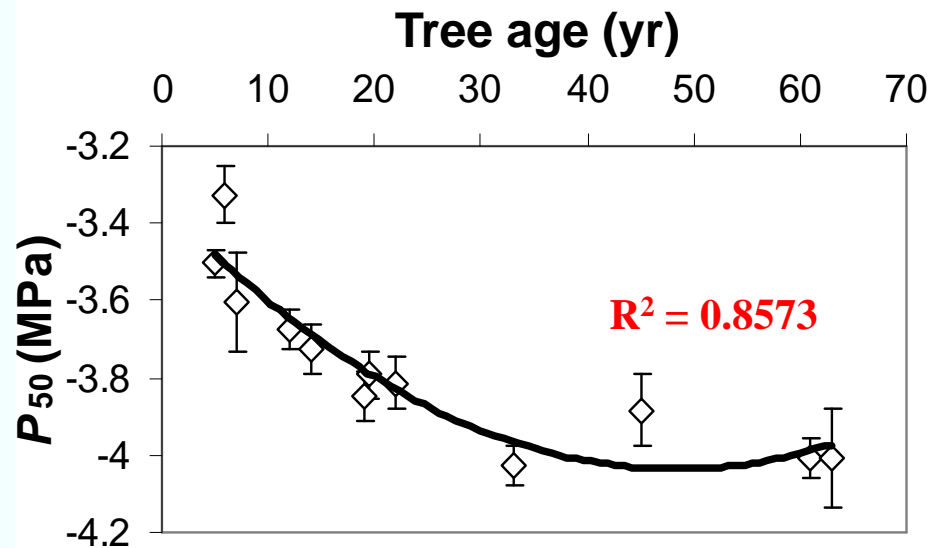

Significant linear trend according to tree height

Tall trees are more cavitation resistant by 0.6 MPa

# Evolution of xylem-specific hydraulic conductivity

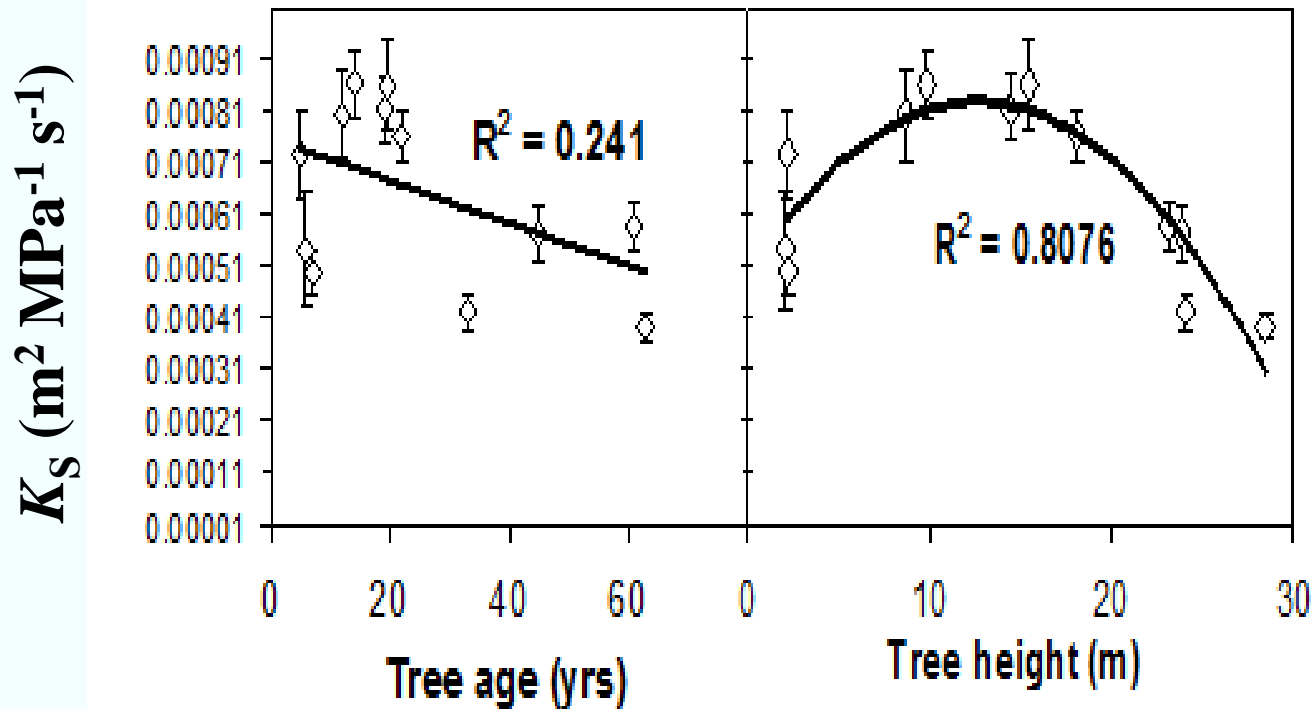

$k_s$  reaches an optimum at 15 m height and then decreases as trees grow taller

# Hydraulic compensation mechanisms

## ✓ **SAFETY: YES**

As cavitation resistance increased with increasing tree height, tall trees could reach lower minimum water potential, thus increasing soil to leaf water potential gradient

## ✓ **EFFICIENCY: NO**

Tall trees did not produce more efficient xylem and had even lower xylem specific hydraulic conductivity.

✓ Hydraulic adjustments that enhanced the ability to cope with vertical gradients of increasing xylem tension were attained at the expense of reduced water transport capacity and efficiency

# Height-related effect within tree crown

Efficiency

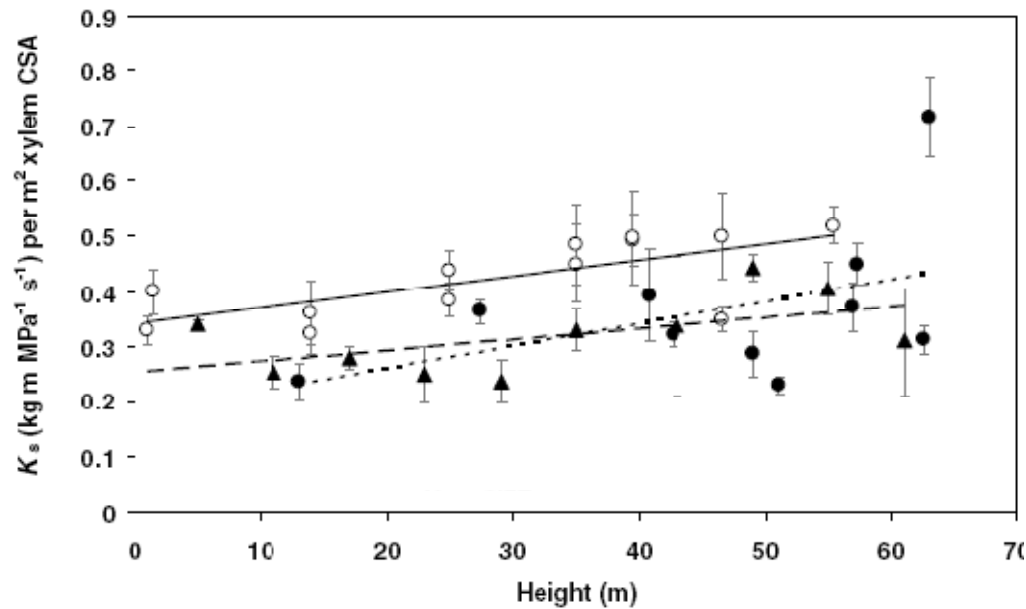

Safety

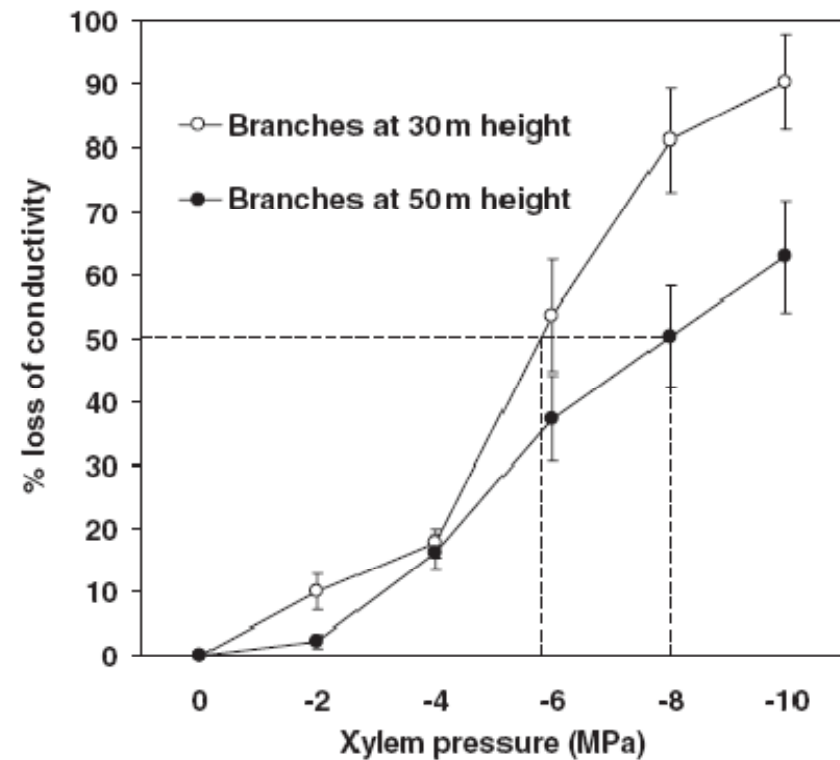

No trade-off in *Sequoia sempervirens*

# Perspectives: xylem anatomy

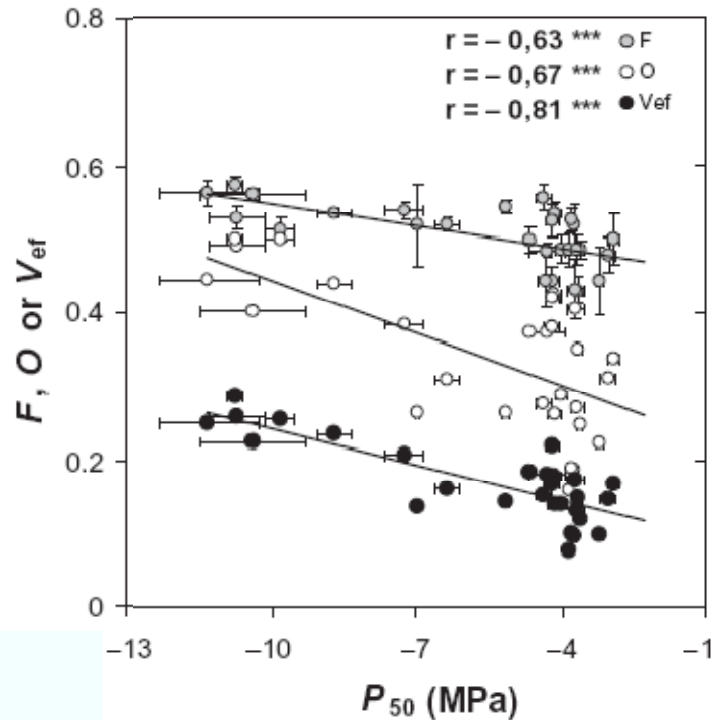



Pit membrane properties (margo flexibility, torus overlap and valve effect) highly correlated with  $P_{50}$

*Delzon et al. 2010 PCE*

Torus overlap increased in Douglas-fir trees along a height gradient of 85 m

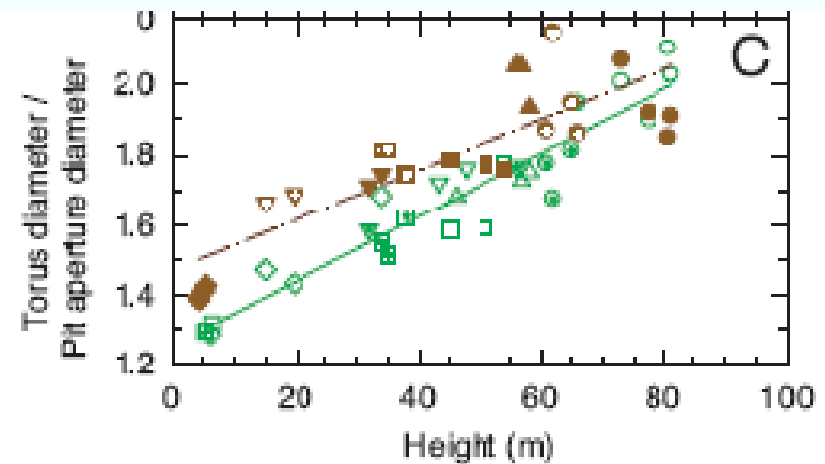
*Domec et al. 2008 PNAS*





Relations hydriques dans des arbres  
en treeline des Andes  
vénézuéliennes.

Dulhoste Raphaël  
Rada Fermin





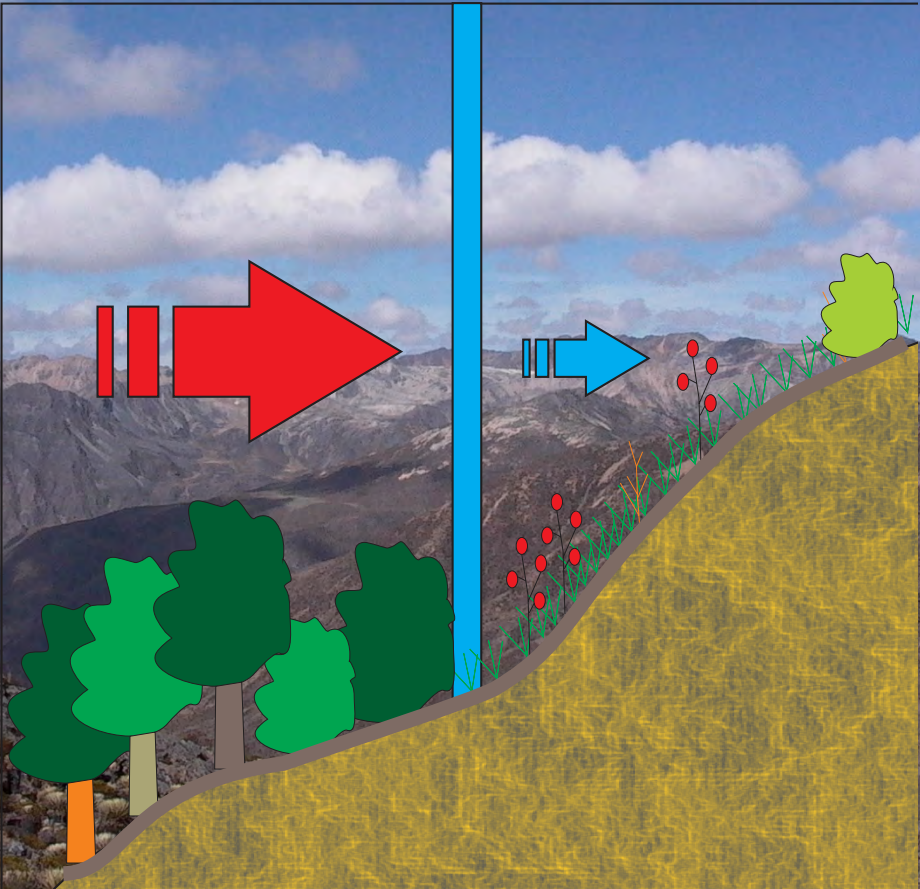
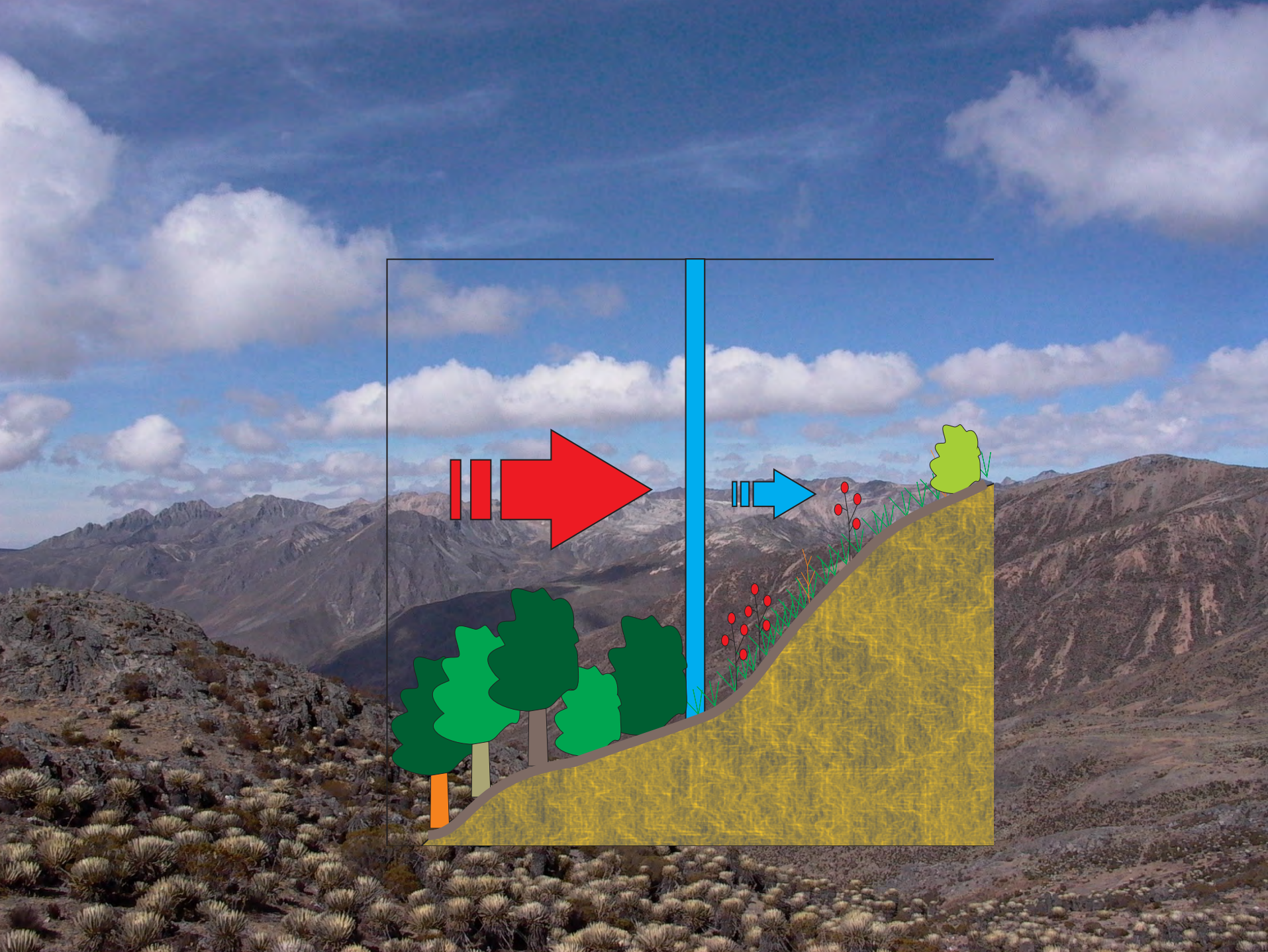

# General Hypothesis

**Climatic stress**

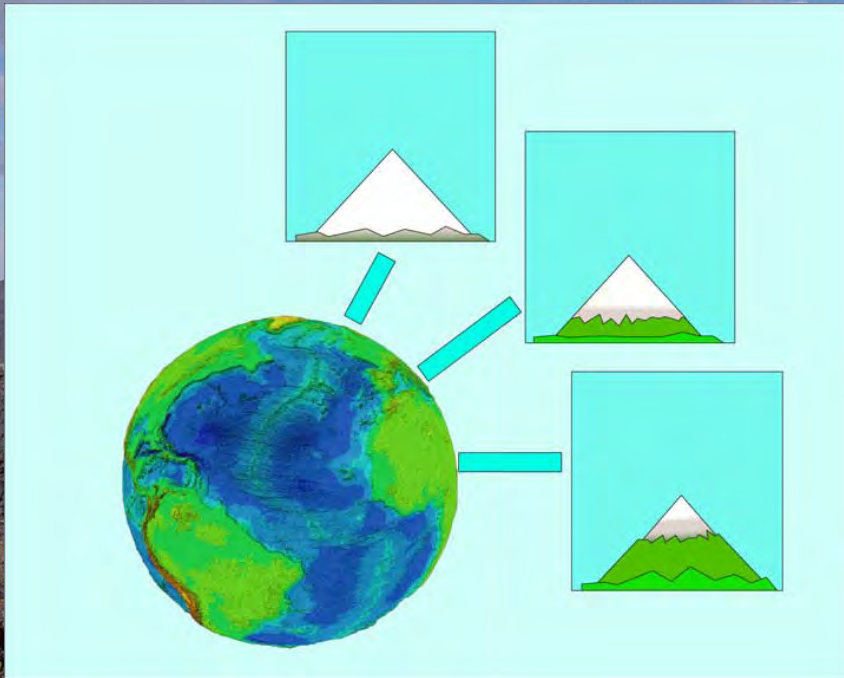

**Disturbance**





# Treeline Structure

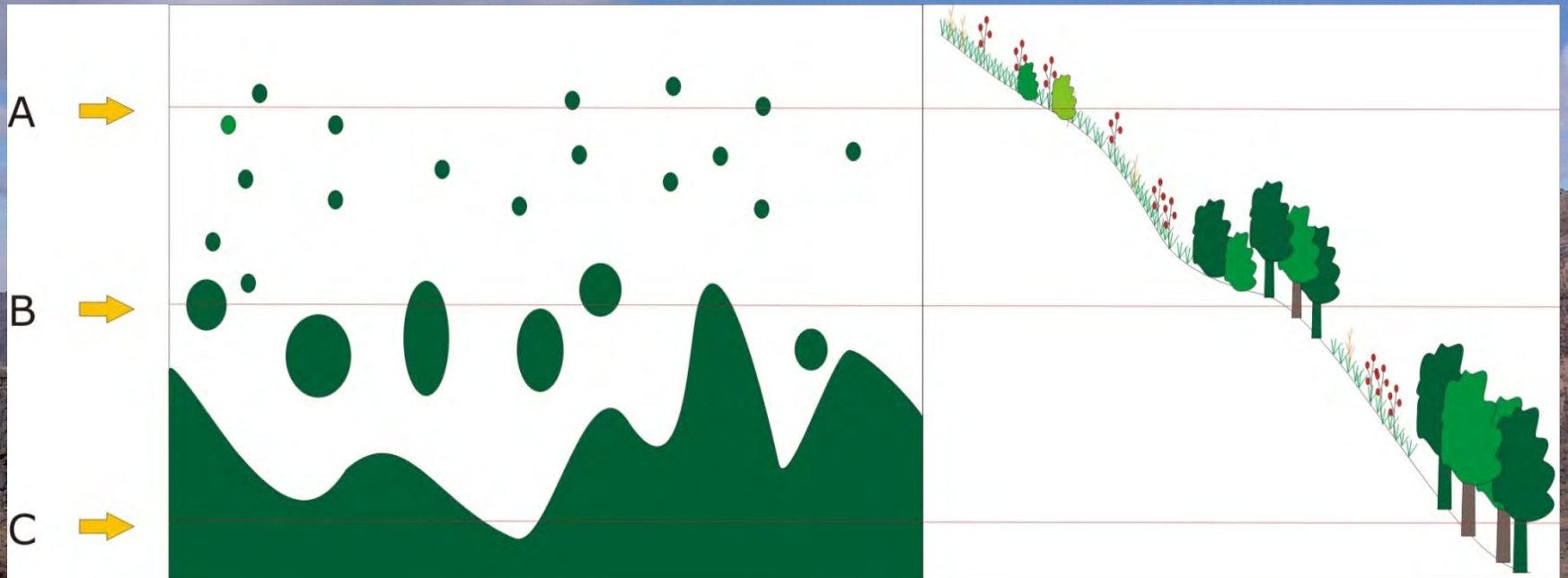

# Our case

Tropical  
Treeline

Freezing  
Temperatures

Water  
Deficit

Low  
Temperature

High  
Radiation

Treeline  
Hypothesis

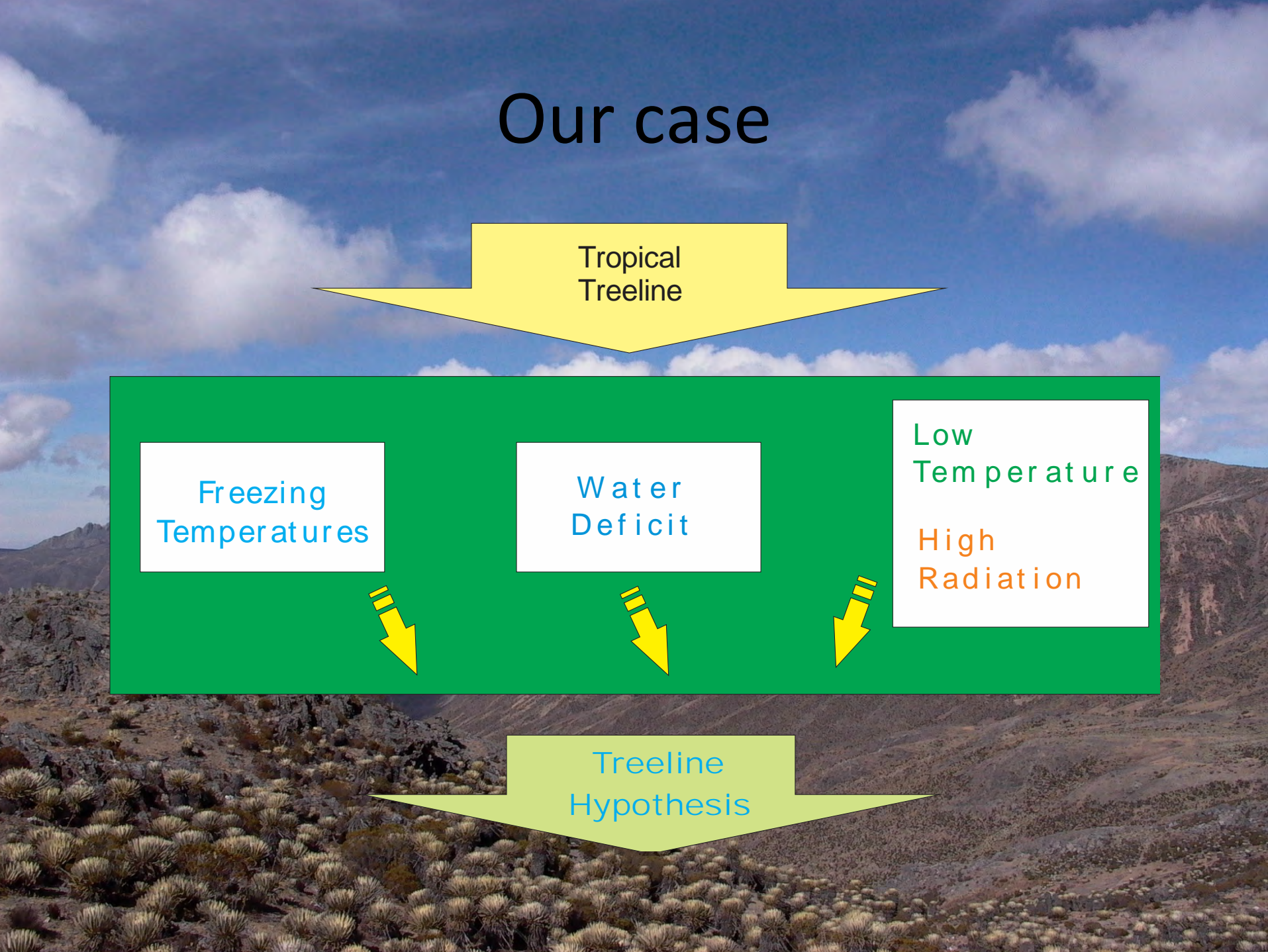

# Tropical Mountains

Leuschner, 2000 .



# Tropical Mountains

Daily water deficit

High VPD





# Tropical Mountains

## Seasonal deficit

- Decreased rainfall (december to march)

*Erika Rodriguez*

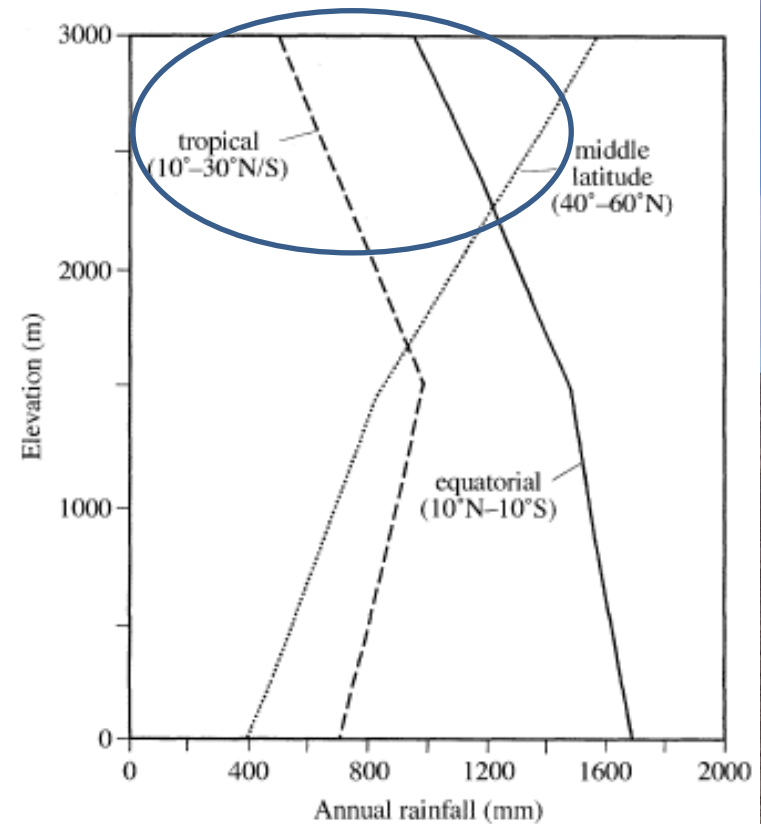

FIG. 5. Change in annual rainfall with elevation in mountains of the equatorial, tropical, and middle-latitude zones based on long-term observations at 1300 weather stations (after Lauscher 1976).

# HYPOTHESIS

- Species adapted to higher altitude in the ecotone present mechanisms to improve their water status under conditions of greater deficit.

# OBJETIVOS

- Determine the minimum water potential of three species of cloud forest-páramo ecotone in adult individuals in the field.
- Identify their various components of water potential.
- Characterize the behavior of the response of stomata to leaf water potential in these species, adult leaves.

# Material & methods

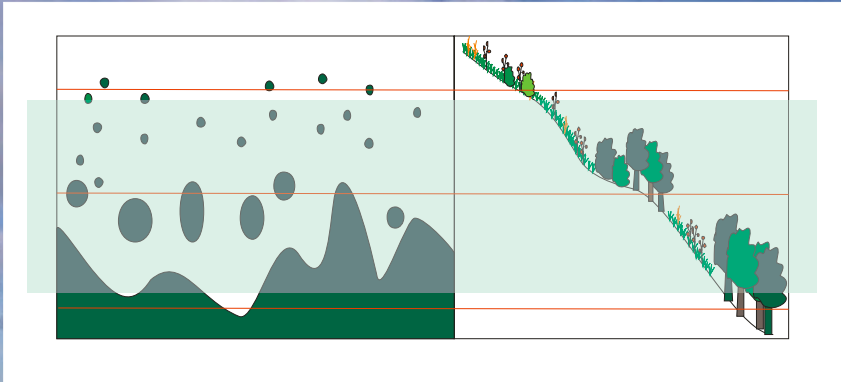

3200

2800



Species

Altitude (m)

*Diplostegium venezuelense*

3200, 3000

*Miconia jahnii*

3150, 3000

*Libanothamnus neriifolius*

3150, 3000, 2800

# SPECIES

- *Diplostephium venezuelense*  
(3200 m, 3000 m)



# SPECIES

- *Libanothamnus neriifolius*  
(3150, 3000, 2800)



# SPECIES

- *Miconia jahnii*  
(3150, 3000)

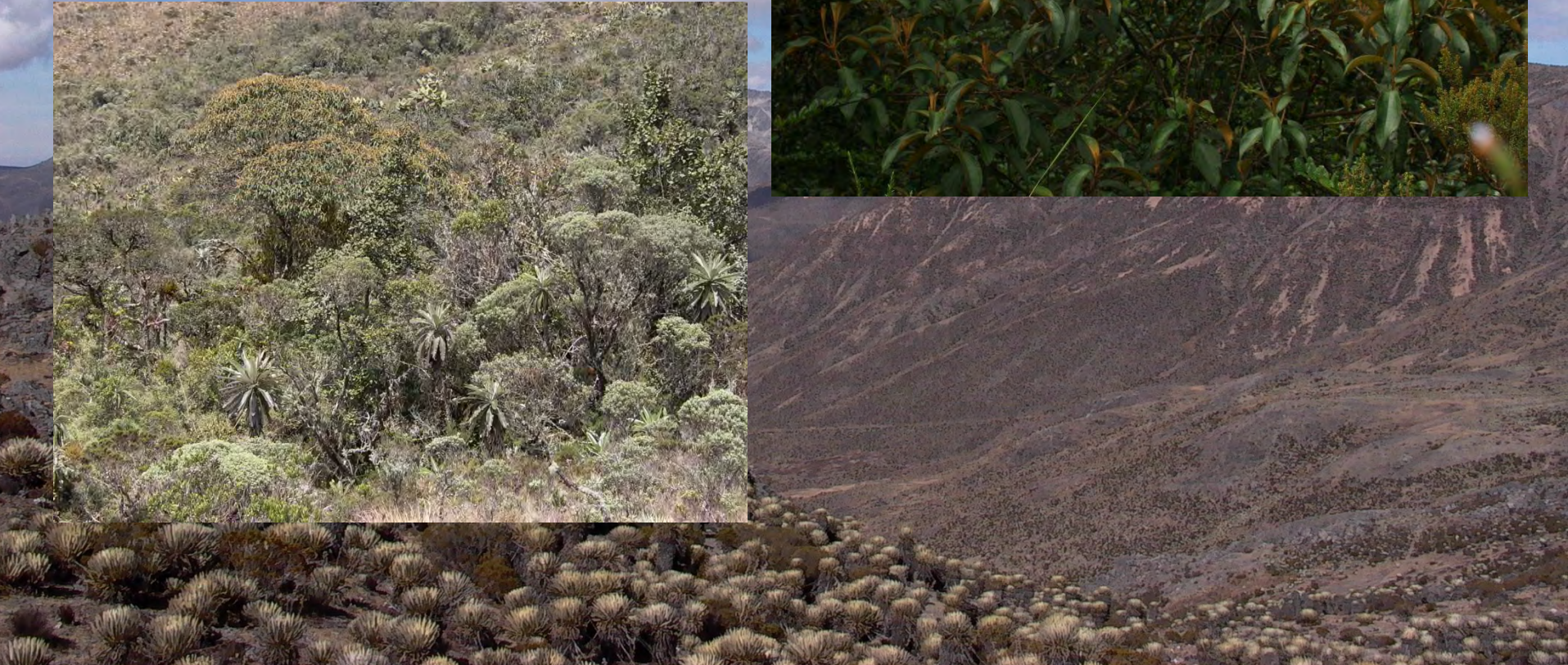

# Minimum ( $\Psi_{lmin}$ ) and predawn ( $\Psi_{lpd}$ ) leaf water potential .

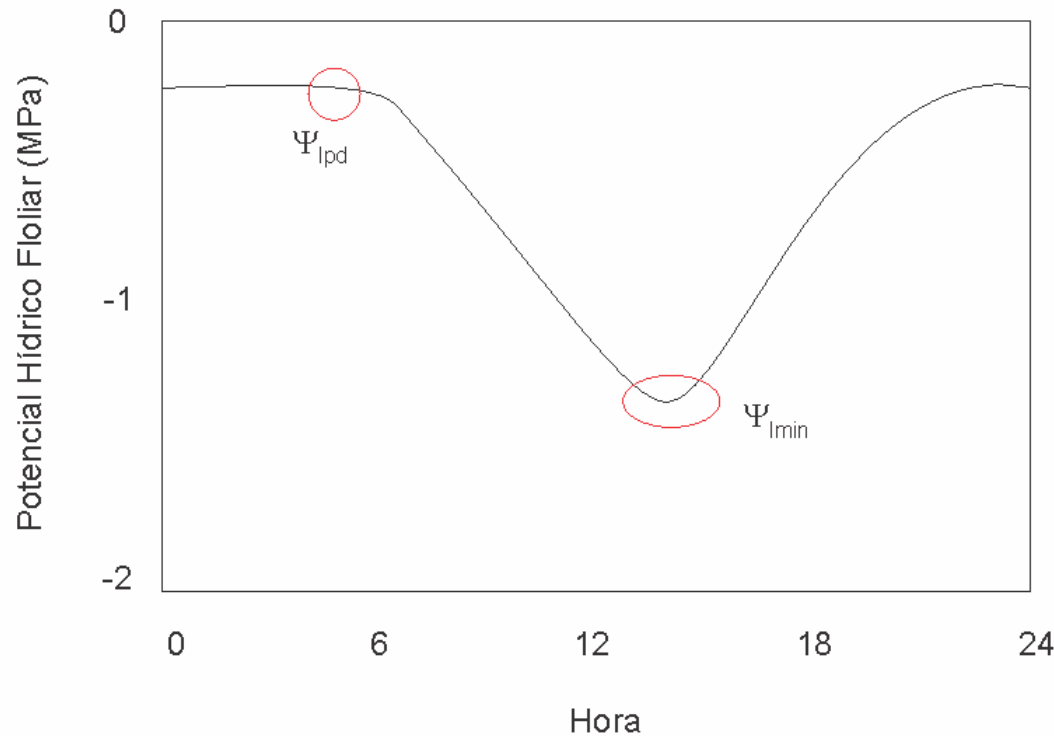



# $\Psi_p$ components

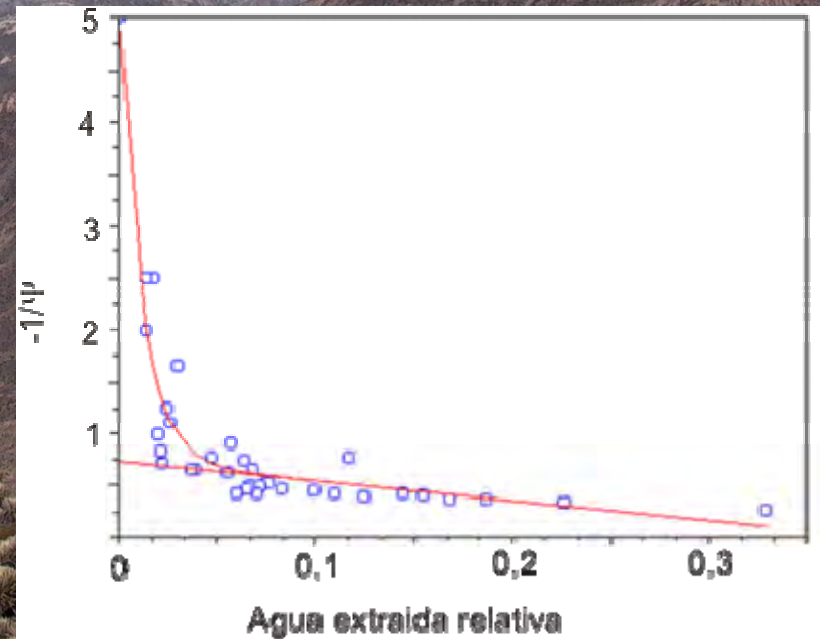
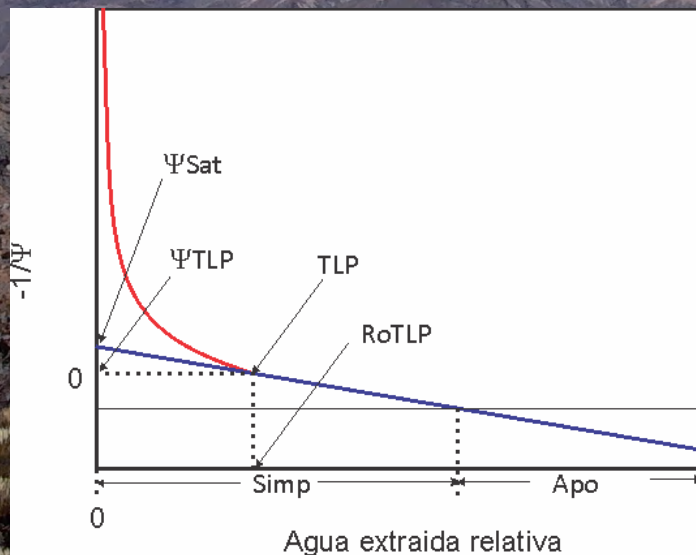
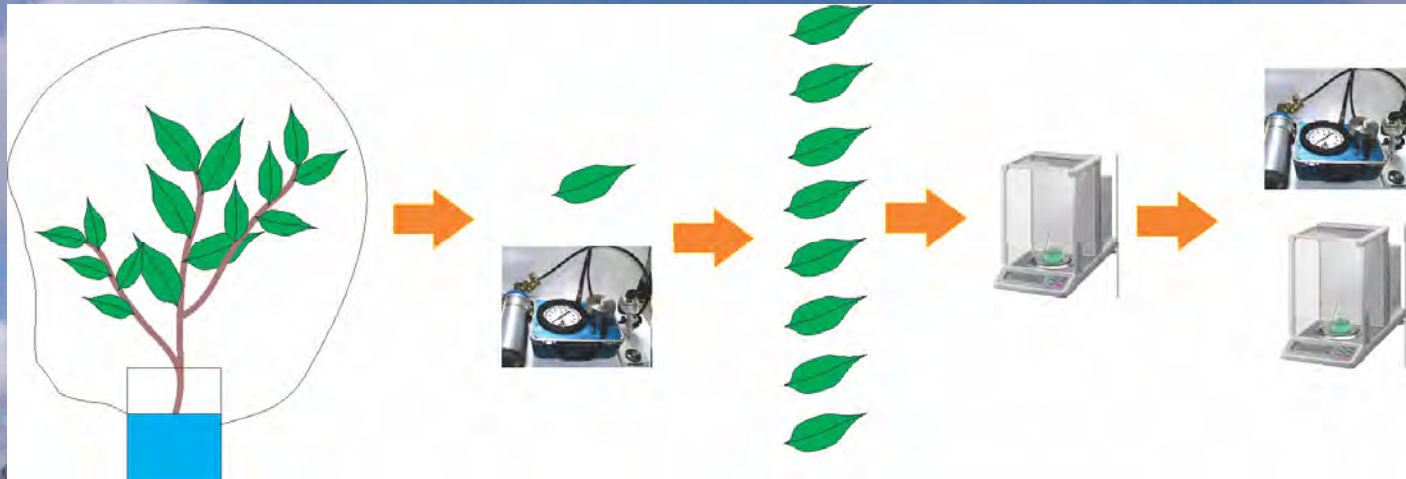

# Curve $g_s - \Psi_p$

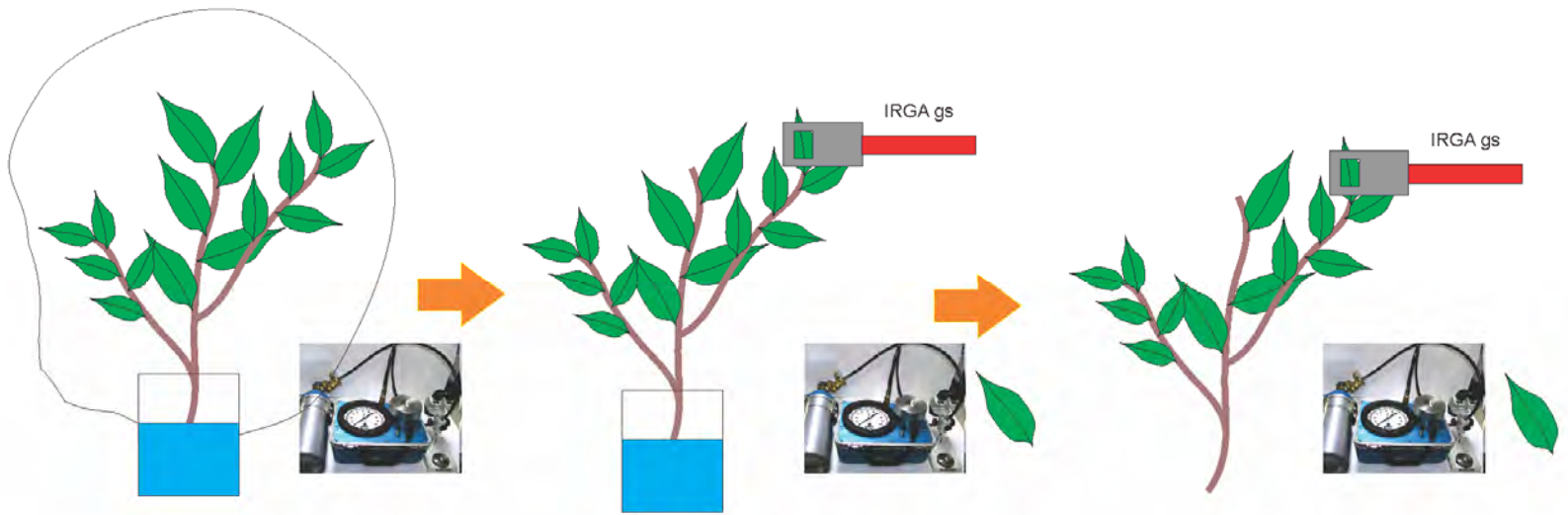

# Results & Discussion

Species	Altitude	$\Psi_{\text{Imin}}$ (Mpa)	$\Psi_{\text{pd}}$ (Mpa)
<i>Diplostegium venezuelense</i>	3200	-1,25 (0,2)	
	3000	-1,15 (0,3)	-0,20 (0,1)
<i>Libanothamnus neriifolius</i>	2800	-0,90 (0,3)	
	3000	-1,05 (0,3)	-0,20 (0,1)
	3150	-1,20 (0,3)	
<i>Miconia jahnii</i>	3000	-1,10 (0,4)	-0,30 (0,1)
	3150	-1,20 (0,3)	

**Field  $\Psi_{\text{I}}$**



# Results & Discussion

Species	Altitude	$\Psi_{\text{Imin}}$ (Mpa)	$\Psi_{\text{pd}}$ (Mpa)
<i>Diplostegium venezuelense</i>	3400*	-1,50 (0,2)	-1,10 (0,2)
	3200	-1,25 (0,2)	
	3000	-1,15 (0,3)	-0,20 (0,1)
<i>Libanothamnus neriifolius</i>	2800	-0,90 (0,3)	
	3000	-1,05 (0,3)	-0,20 (0,1)
	3150	-1,20 (0,3)	
<i>Miconia jahnii</i>	3000	-1,10 (0,4)	-0,30 (0,1)
	3150	-1,20 (0,3)	

Field  $\Psi_{\text{I}}$

# $\Psi$ , Component

	Alt	Saison	$Ro_{t_{lp}}$	$\Psi_{t_{lp}}$	$\Psi_{sat}$	$A_{simp}$	$\epsilon_{max}$
<i>Diplostephium venezuelense</i>	3000	Wet	0,07 (0,003)	-0,91 (0,04)	-0,70 (0,04)	0,31 (0,01)	11,31* (0,19)
		Dry	0,19 (0,012)	-1,06 (0,01)	-0,75 (0,02)	0,40 (0,01)	8,25* (0,56)
	3200	Wet	0,13 (0,009)	-1,00 (0,06)	-0,81 (0,08)	0,57 (0,05)	15,66* (2,35)
		Dry	0,22 (0,012)	-1,47 (0,02)	-1,14 (0,01)	0,64 (0,02)	6,73* (0,30)

# $\Psi$ , Component

	Alt	Saison	$Ro_{t1p}$	$\Psi_{t1p}$	$\Psi_{sat}$	$A_{simp}$	$\epsilon_{max}$
<i>Diplostephium venezuelense</i>	3000	Wet	0,07 (0,003)	-0,91 (0,04)	-0,70 (0,04)	0,31 (0,01)	11,31* (0,19)
		Dry	0,19 (0,012)	-1,06 (0,01)	-0,75 (0,02)	0,40 (0,01)	8,25* (0,56)
	3200	Wet	0,13 (0,009)	-1,00 (0,06)	-0,81 (0,08)	0,57 (0,05)	15,66* (2,35)
		Dry	0,22 (0,012)	-1,47 (0,02)	-1,14 (0,01)	0,64 (0,02)	6,73* (0,30)
	3400 <sup>a</sup>	Wet	0,13 (0,013)	-1,17* (0,26)	-0,88* (0,23)	0,57 (0,09)	12,52 (2,01)
		Dry	0,12 (0,038)	-1,81* (0,11)	-1,68* (0,13)	0,59 (0,05)	11,42 (3,81)

# $\Psi_t$ Component

	Alt	Saison	$Ro_{t p}$	$\Psi_{t p}$	$\Psi_{sat}$	$A_{simp}$	$\epsilon_{max}$
<i>Libanothamnus neriifolius</i>	2800	Wet	0,06 (0,007)	-1,13 (0,27)	-1,01 (0,10)	0,60 (0,06)	20,22* (1,87)
		Dry	0,08 (0,017)	-1,77 (0,18)	-1,44 (0,24)	0,41 (0,06)	12,80* (2,26)
	3000	Wet	0,09 (0,042)	-1,36 (0,11)	-0,93 (0,09)	0,31 (0,04)	19,16* (2,72)
		Dry	0,15 (0,003)	-1,52 (0,08)	-1,23 (0,14)	0,60 (0,09)	5,51* (3,08)
	3150	Wet	0,08 (0,018)	-1,60 (0,09)	-1,25 (0,05)	0,38 (0,06)	19,20* (4,29)
		Dry	0,13 (0,023)	-2,04 (0,04)	-1,64 (0,11)	0,60 (0,04)	10,53* (0,80)

# $\Psi$ , Component

	Alt	Saison	$RO_{t\bar{p}}$	$\Psi_{t\bar{p}}$	$\Psi_{sat}$	$A_{simp}$	$\epsilon_{max}$
<i>Miconia jahnii</i>	3000	Wet	0,09 (0,015)	-1,06 (0,07)	-0,70 (0,13)	0,37 (0,12)	14,05* (3,61)
		Dry	0,21 (0,012)	-1,85 (0,06)	-1,08 (0,13)	0,47 (0,15)	11,51* (0,52)
	3150	Wet	0,07 (0,011)	-1,12 (0,13)	-0,96 (0,11)	0,48 (0,13)	26,28* (1,85)
		Dry	0,16 (0,021)	-1,53 (0,12)	-1,25 (0,17)	0,48 (0,14)	20,44* (1,87)



gs vs  $\Psi_i$ .

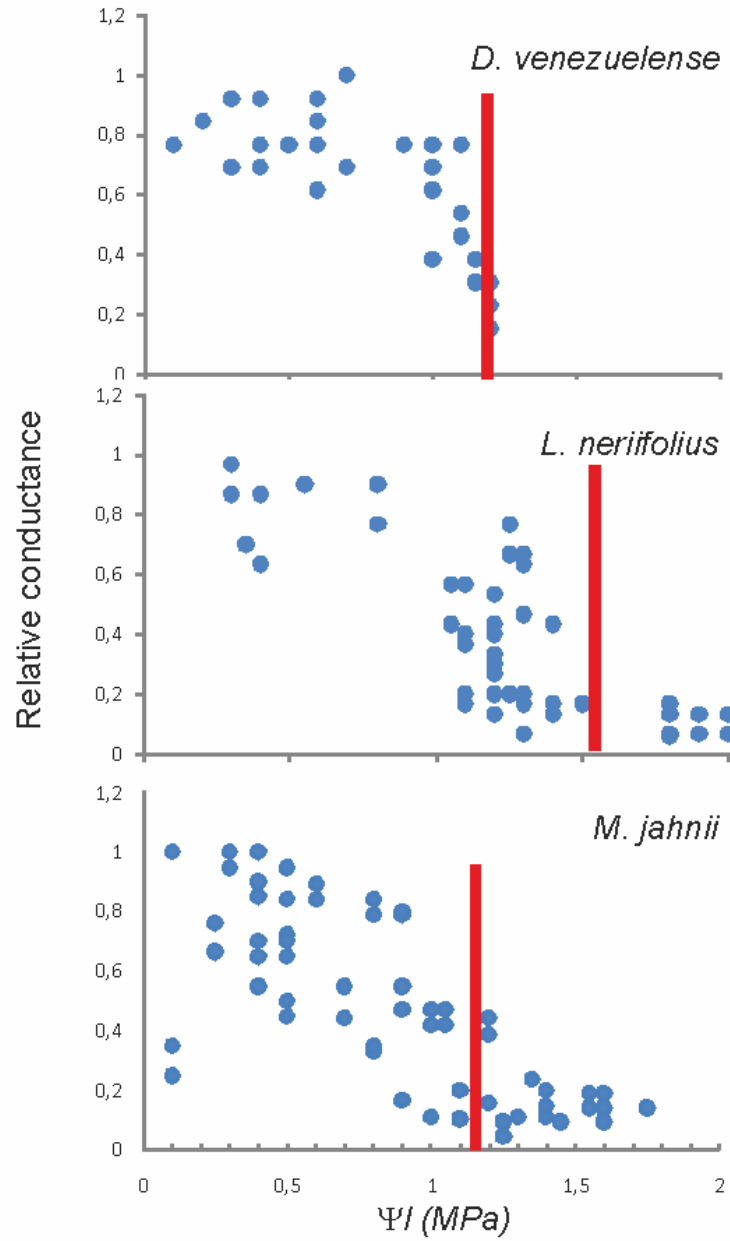

# Discussion





Merci



# Calcium in Vulnerability to Cavitation (VC)

S. Herbette, A. Tixier, H. Awad, E. Mellerowicz, H. Cochard.

# Mechanism of cavitation: air seeding hypothesis

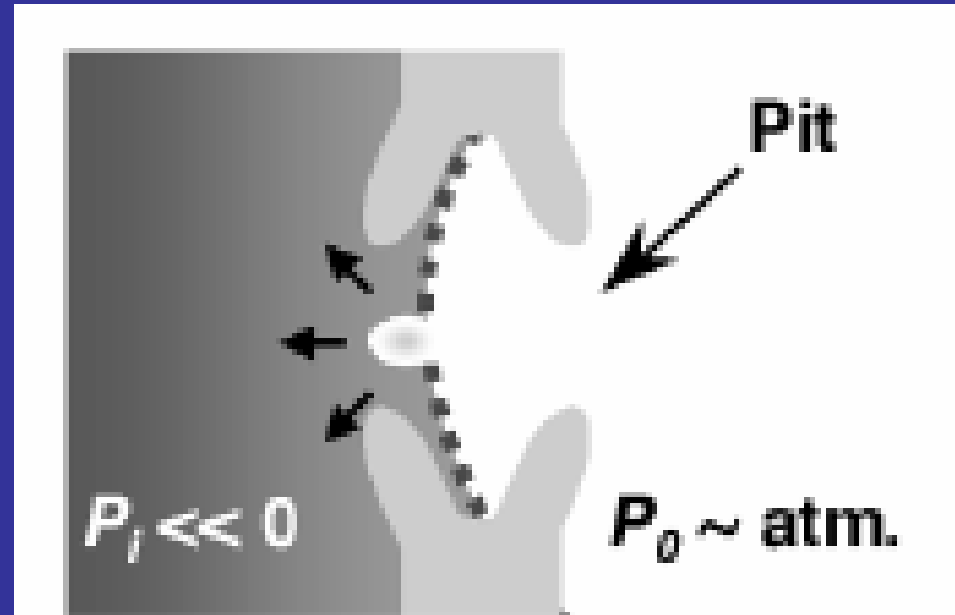
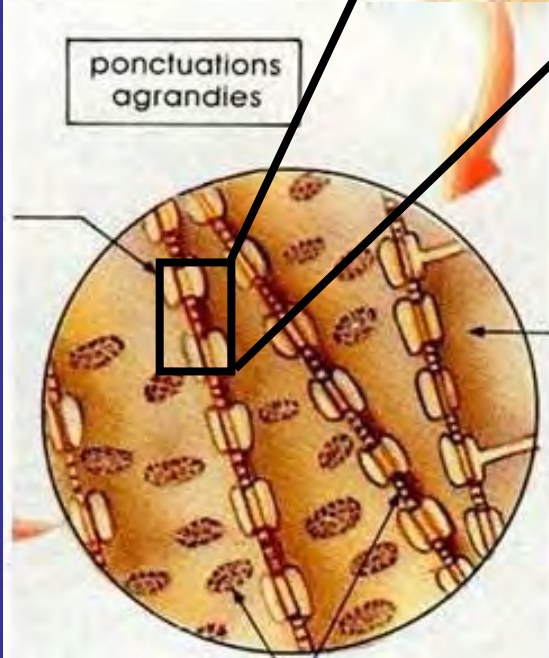
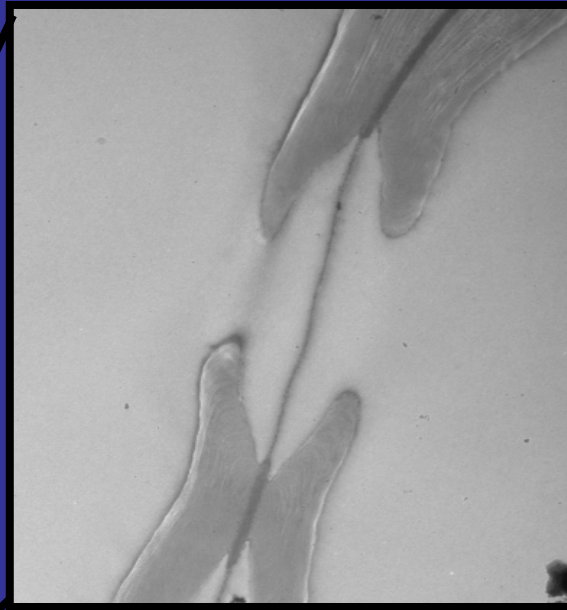
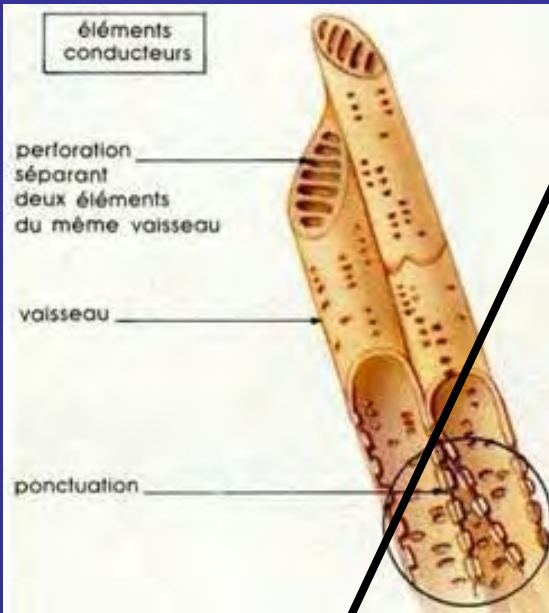

# Pit membrane composition

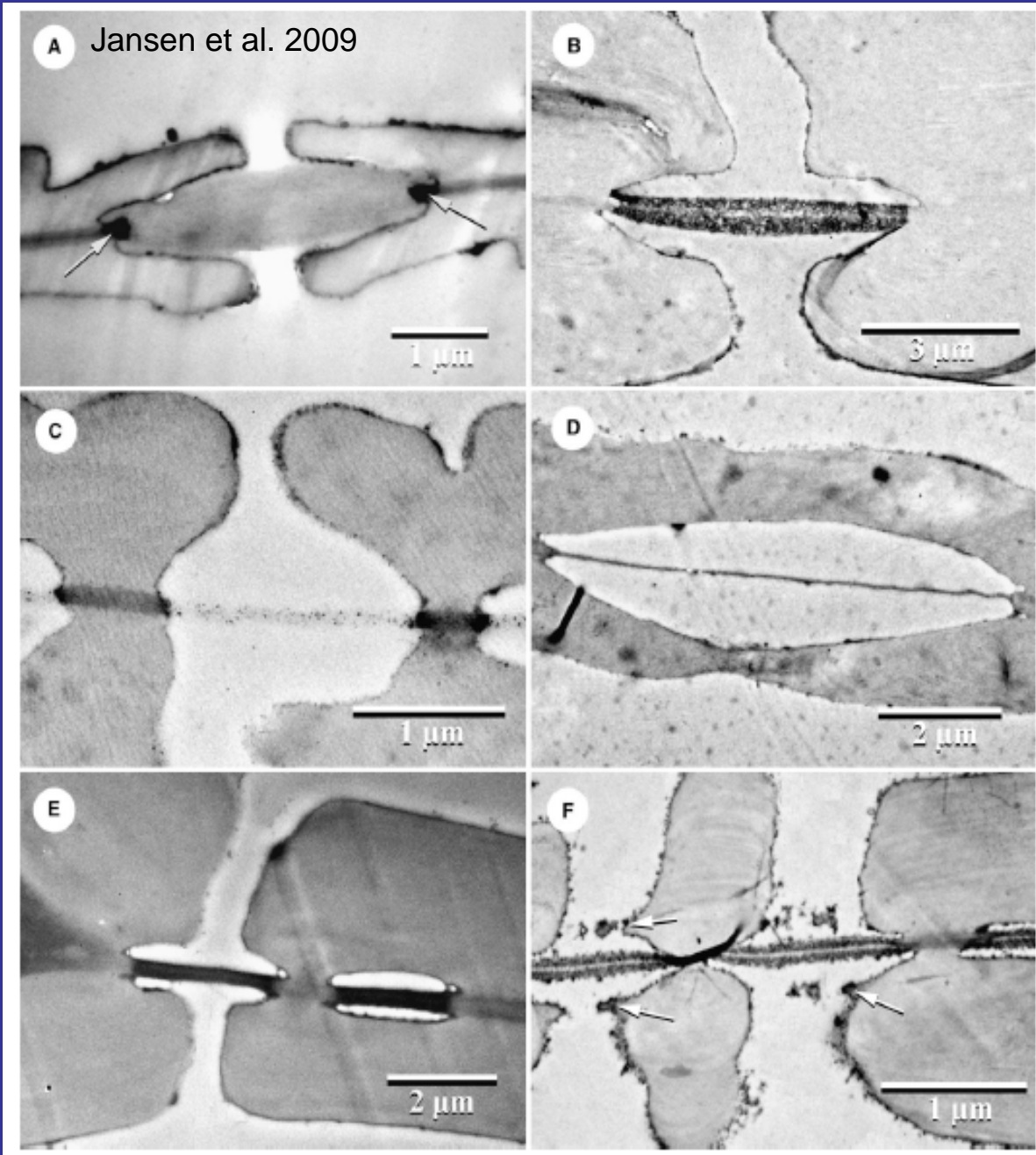

Great variations  
between species

# Pit membrane composition

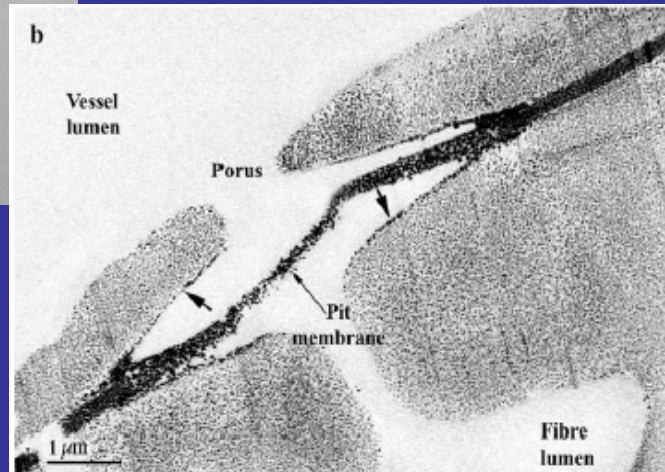
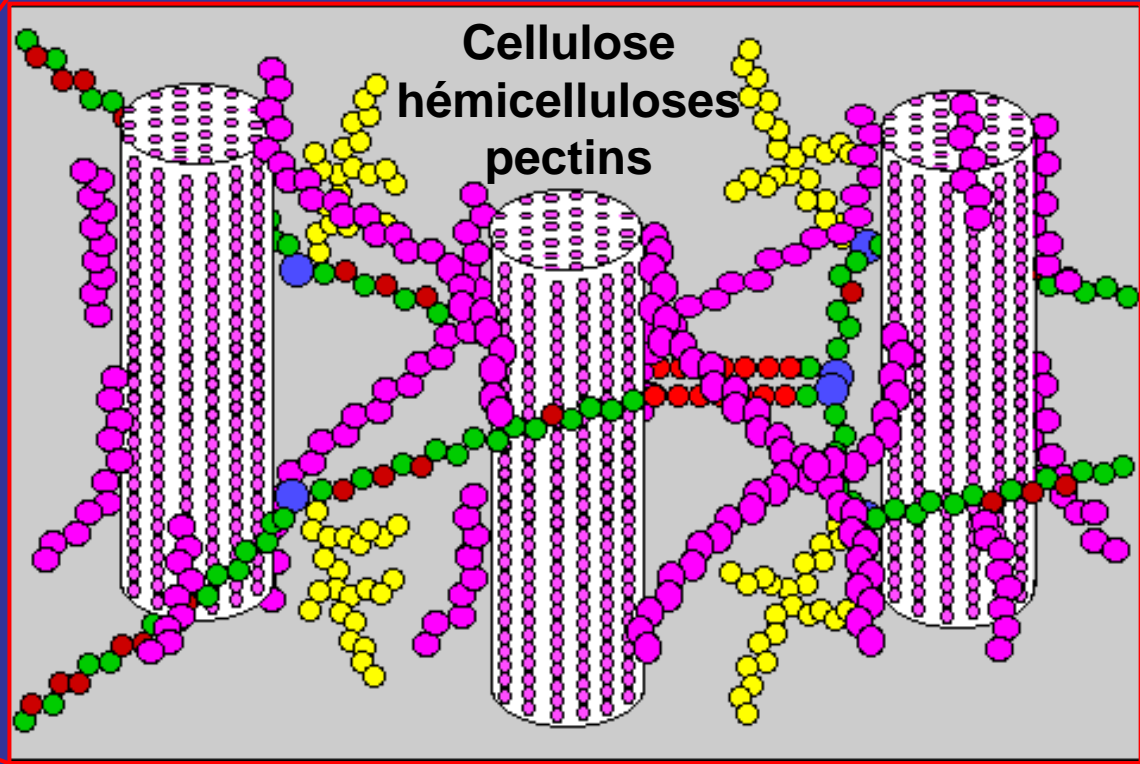
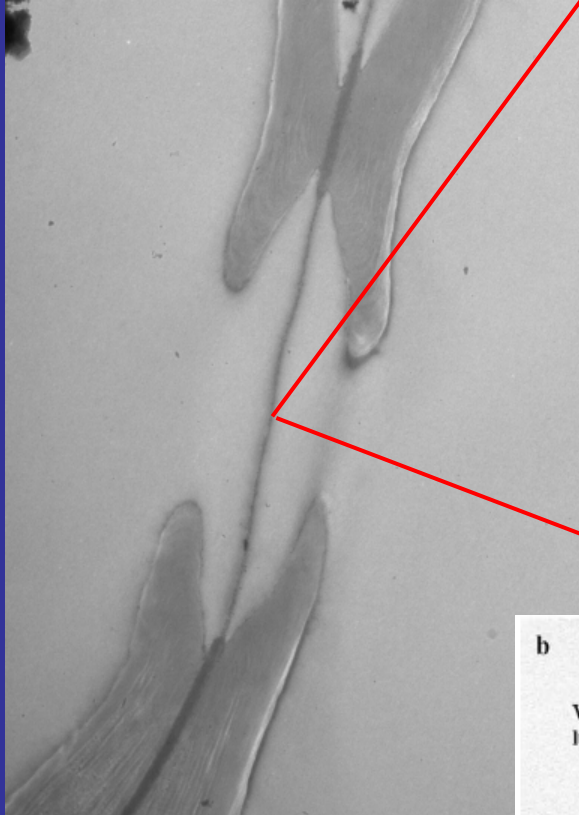

and lignins ?

Lignins stained using  $\text{KMnO}_4$  in pit membrane from beech latewood (Fromm et al., 2003)

# pit membrane composition: what about the hemicelluloses?

Immunolabelling of **mannanes**  
(O-Acetyl-galactoglucmannans)

*Cryptomeiria japonica*

Early formation  
stage of the pit

Pit differentiation

Mature pit

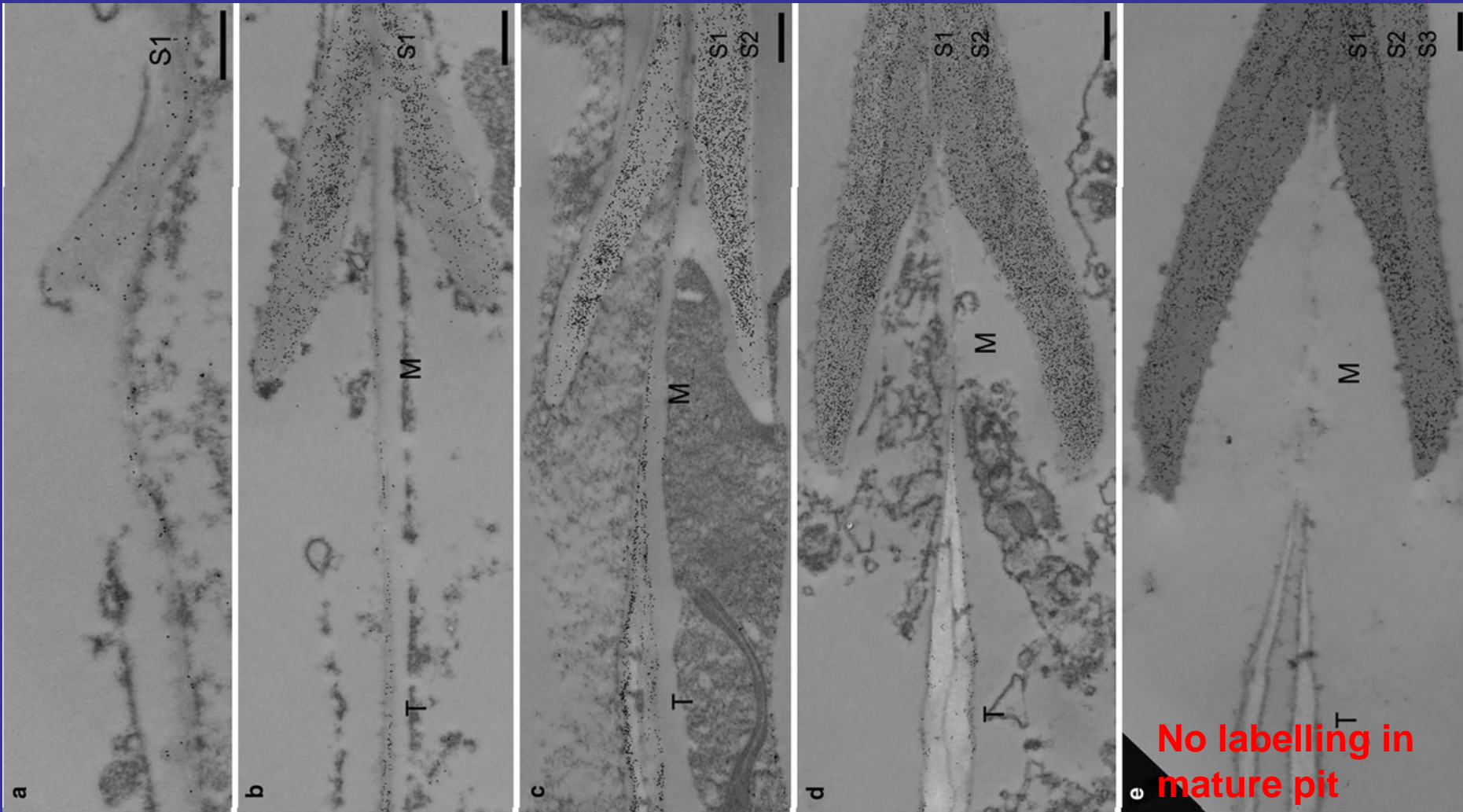



# pit membrane composition: what about the hemicelluloses?

Early formation stage of the pit

Pit differentiation

Mature pit

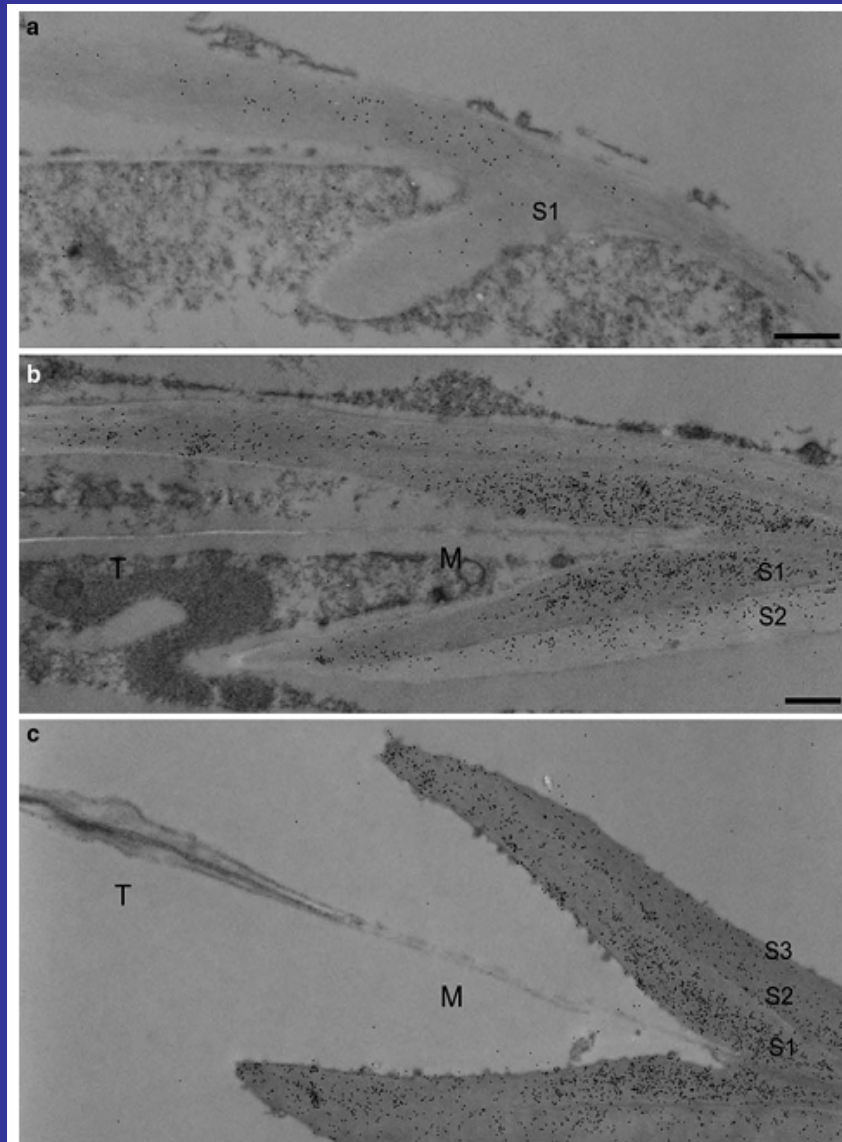

Immunolabelling of xylanes  
(Arabino-4-O-methylglucuronoxylans)

Kim et al., 2011

pit membrane composition: are there pectins ?

Immunolabelling of homogalacturonans (HG) domains of pectins.

**JIM7** recognize highly methylated HG

**JIM5** recognize low methylated HG

*Populus trichocarpa x deltoides*

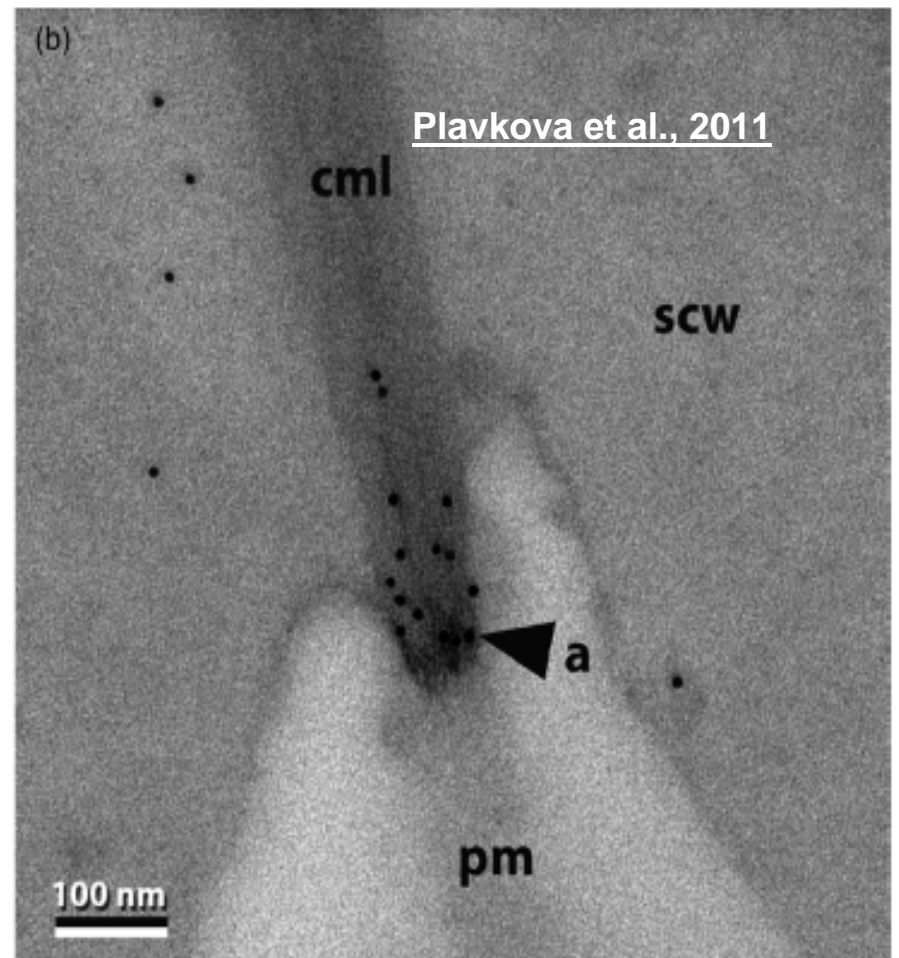
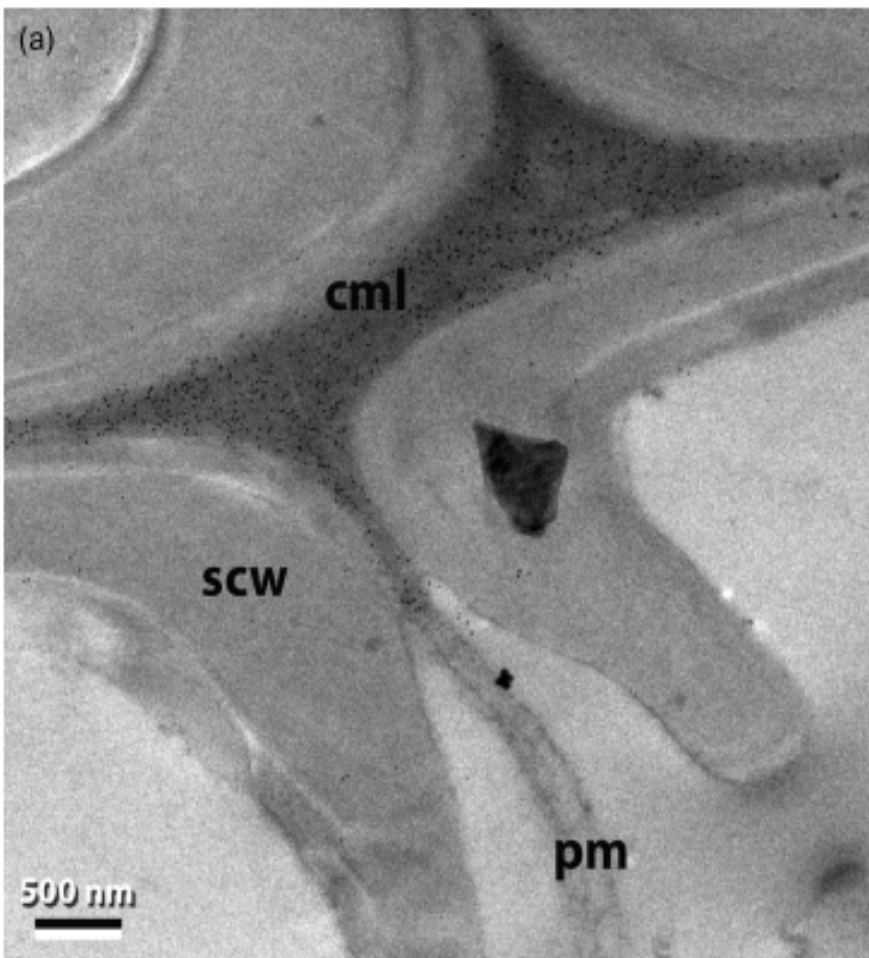

# Pit membrane composition

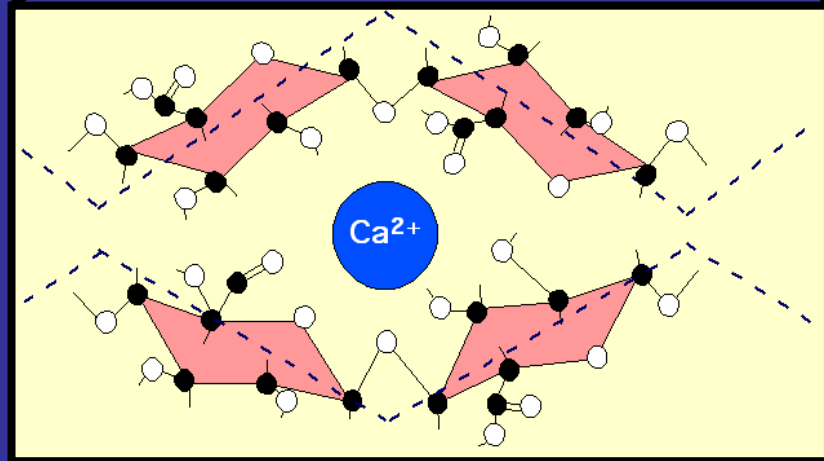
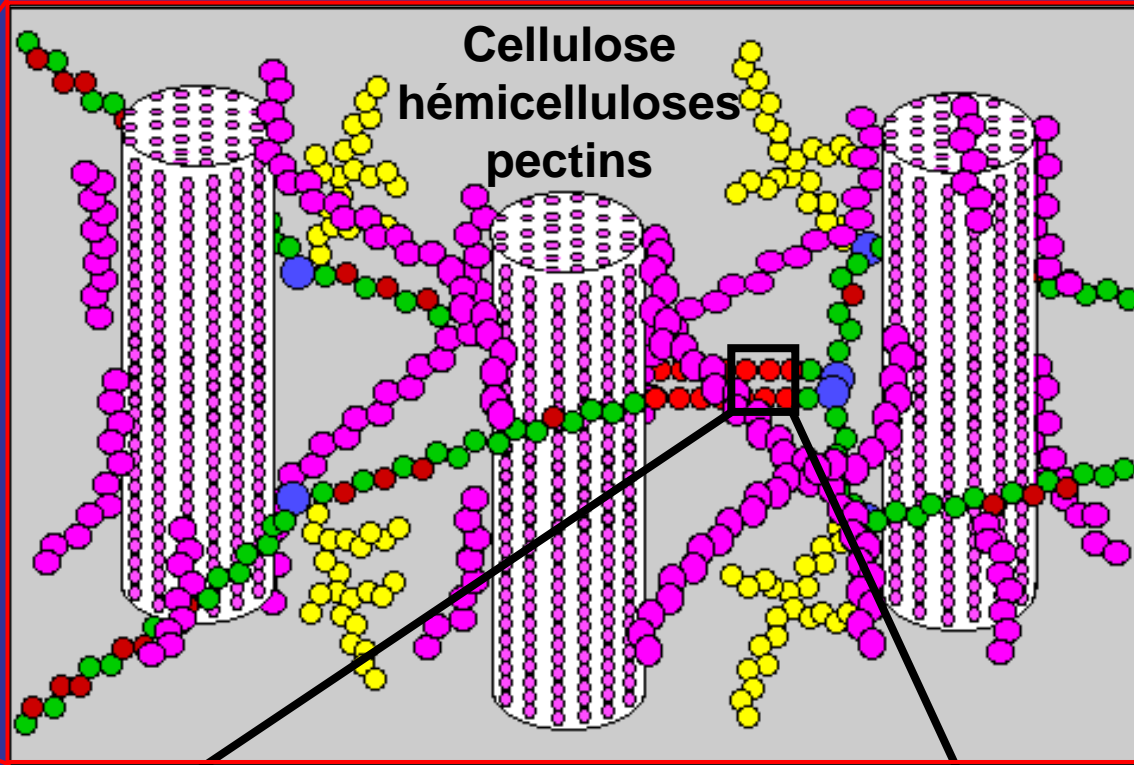
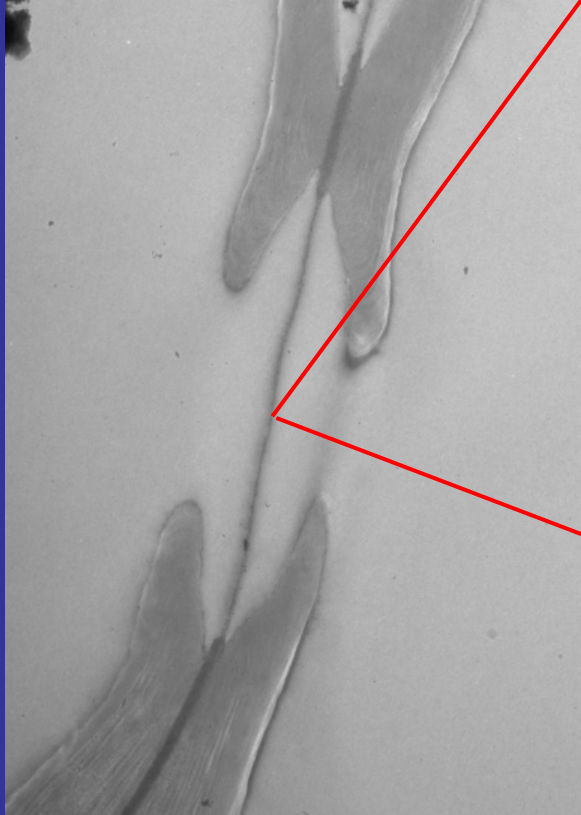

# Calcium precipitation or chelation in the xylem

## And effect on the VC



Perfused Solutions	$P_{50}$ MPa
Control	$-3.09^a, \alpha (\pm 0.03)$
Water	$-3.11^a, \alpha (\pm 0.06)$
NaPO <sub>4</sub> , pH 4	$-2.99^{ab}, \alpha (\pm 0.13)$
NaPO <sub>4</sub> , pH 10	$-2.03^d (\pm 0.08)$
EGTA	$-2.58^{bc} (\pm 0.14)$
Oxalic acid, pH 2	$-2.33^{cd} (\pm 0.13)$
Oxalic acid, pH 5	$-2.76^{abc} (\pm 0.19)$
Tris-HCl, pH 6	$-3.06^a (\pm 0.01)$
Tris-HCl, pH 8	$-3.00^a (\pm 0.02)$
CaCl <sub>2</sub> , 10 mM	$-3.03^a (\pm 0.11)$
NaPO <sub>4</sub> , pH 10 → Tris-HCl, pH 10	$-2.26^b (\pm 0.38)$
NaPO <sub>4</sub> , pH 10 → Tris-HCl, pH 10 + CaCl <sub>2</sub>	$-3.06^a (\pm 0.14)$

# Calcium precipitation or chelation in the xylem And effect on the VC

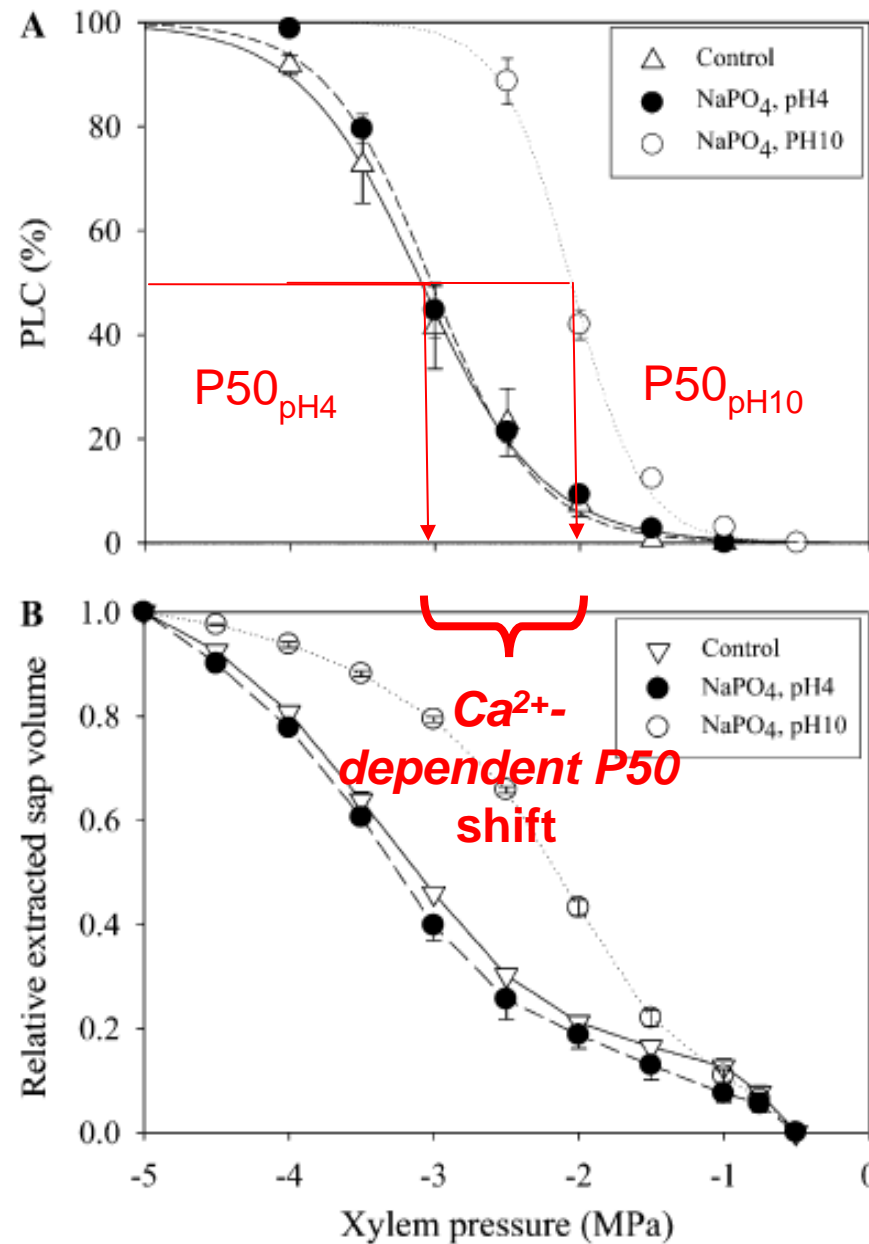

# Calcium and variability of VC



...between species

...within species

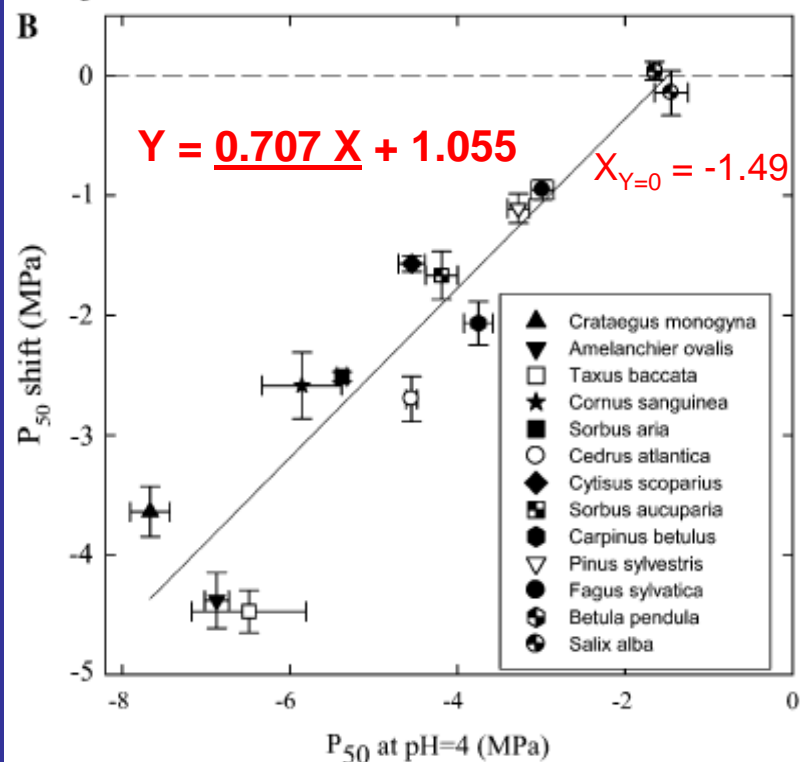
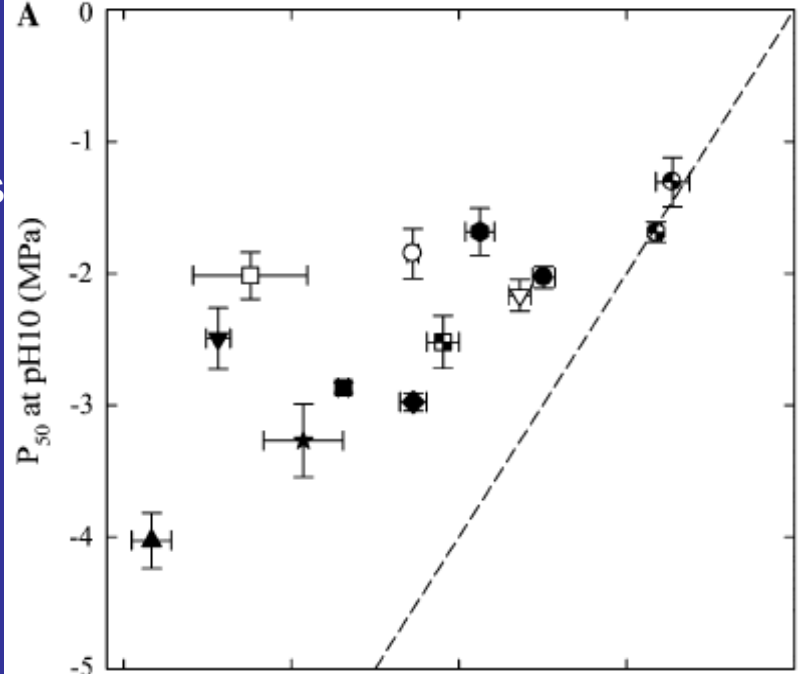
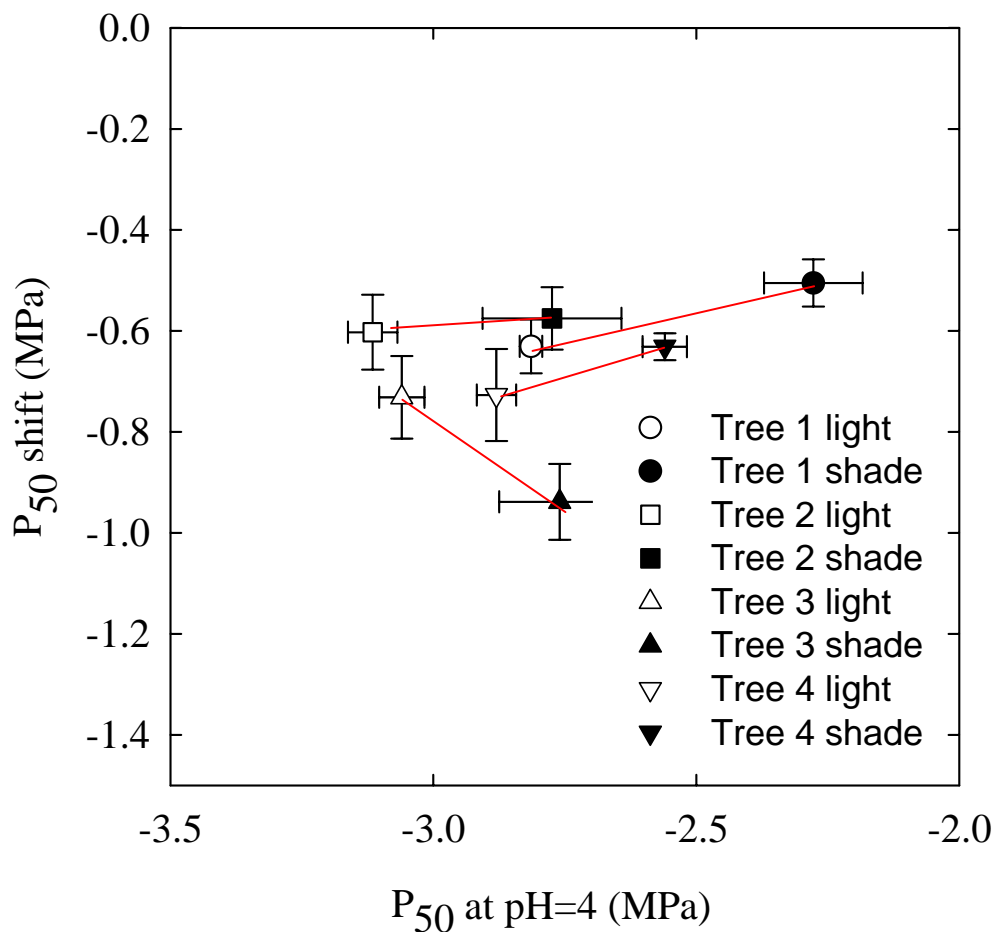

# Genetic control of the role of Calcium in VC

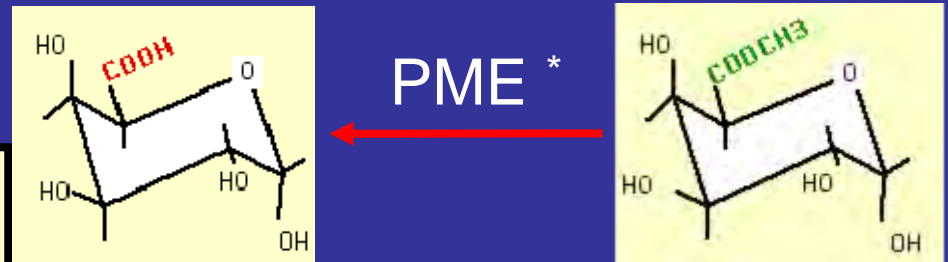
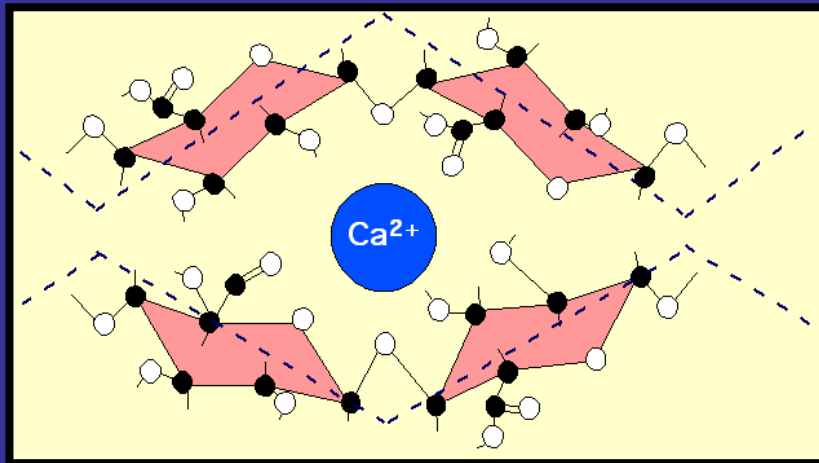
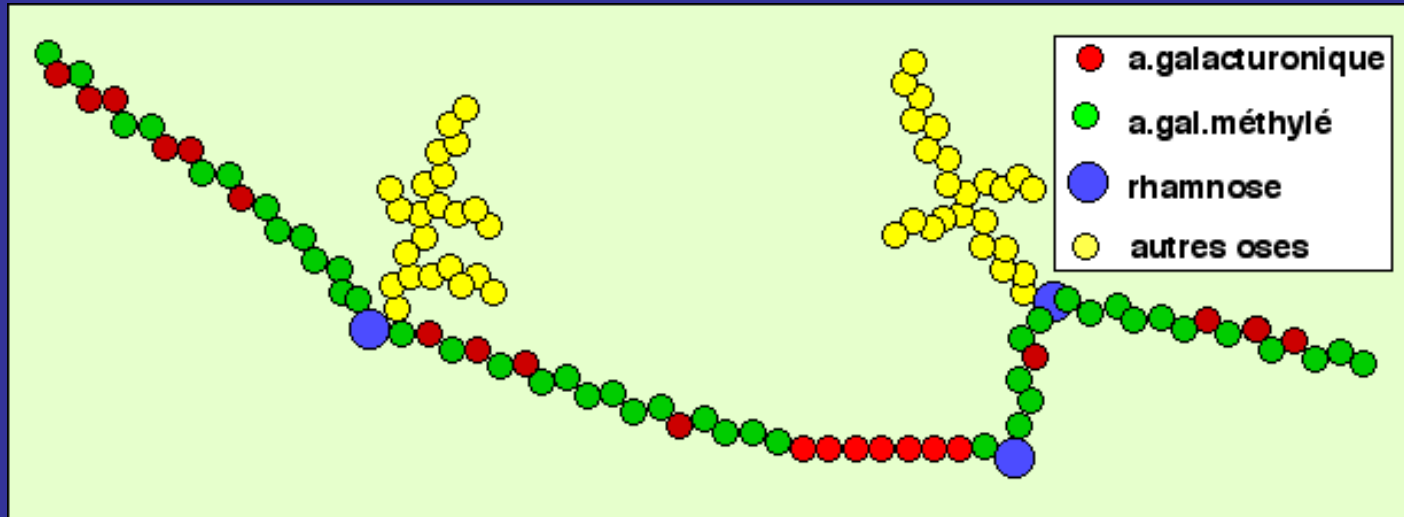

\* PME : Pectine methyl esterase

# Genetic control of the role of Calcium in VC

## Pectin Methyl Esterase Inhibits Intrusive and Symplastic Cell Growth in Developing Wood Cells of *Populus*<sup>1,2[W][OA]</sup>

Anna Siedlecka, Susanne Wiklund, Marie-Amélie Péronne, Fabienne Micheli<sup>3</sup>, Joanna Leśniewska<sup>4</sup>, Ingmar Sethson, Ulf Edlund, Luc Richard, Björn Sundberg\*, and Ewa J. Mellerowicz



	T89 (control)	7s (PME+)	2Bs (PME++)
$\Psi_p$ , MPa ( $\pm$ S.D.)	-0.55 ( $\pm$ 0.053)	-0.53 ( $\pm$ 0.047)	-0.54 ( $\pm$ 0.048)
$\Psi_m$ , MPa ( $\pm$ S.D.)	-1.22 ( $\pm$ 0.087)	-1.23 ( $\pm$ 0.13)	-1.19 ( $\pm$ 0.094)
Height, m ( $\pm$ S.D.)	1.24 ( $\pm$ 0.12)	1.29 ( $\pm$ 0.055)	1.25 ( $\pm$ 0.13)
Conductivity, ( $\pm$ S.D.)	1.96 ( $\pm$ 0.47)	2.08 ( $\pm$ 0.32)	2.34 ( $\pm$ 0.33)
Embolism rate, % ( $\pm$ S.D.)	34.3 ( $\pm$ 15.3)	28.1 ( $\pm$ 22.5)	24.0 ( $\pm$ 13.3)



# Effect of PME overexpression in VC

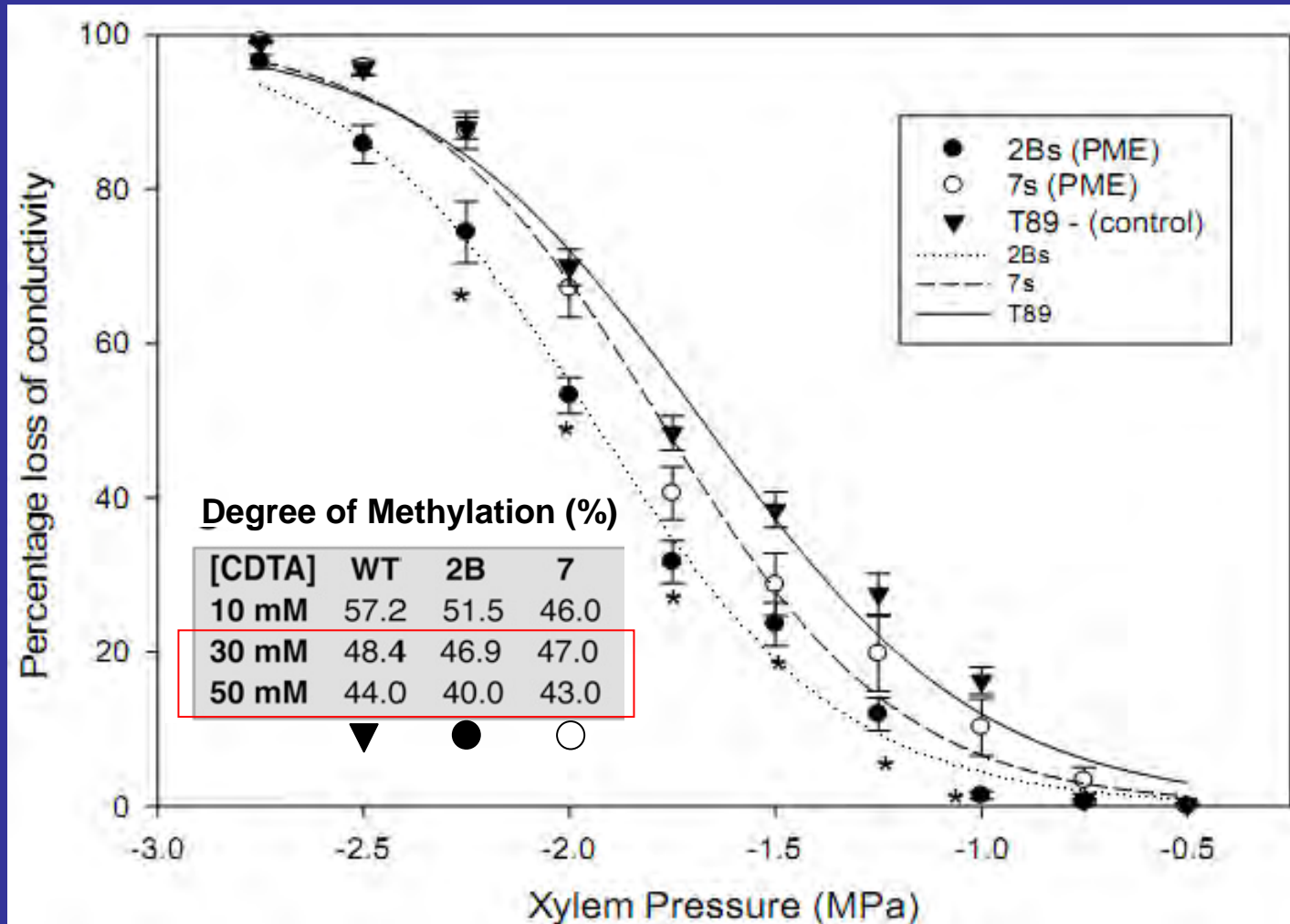

**Increase in PME causes a decrease in VC**

# Effect of PME overexpression in VC

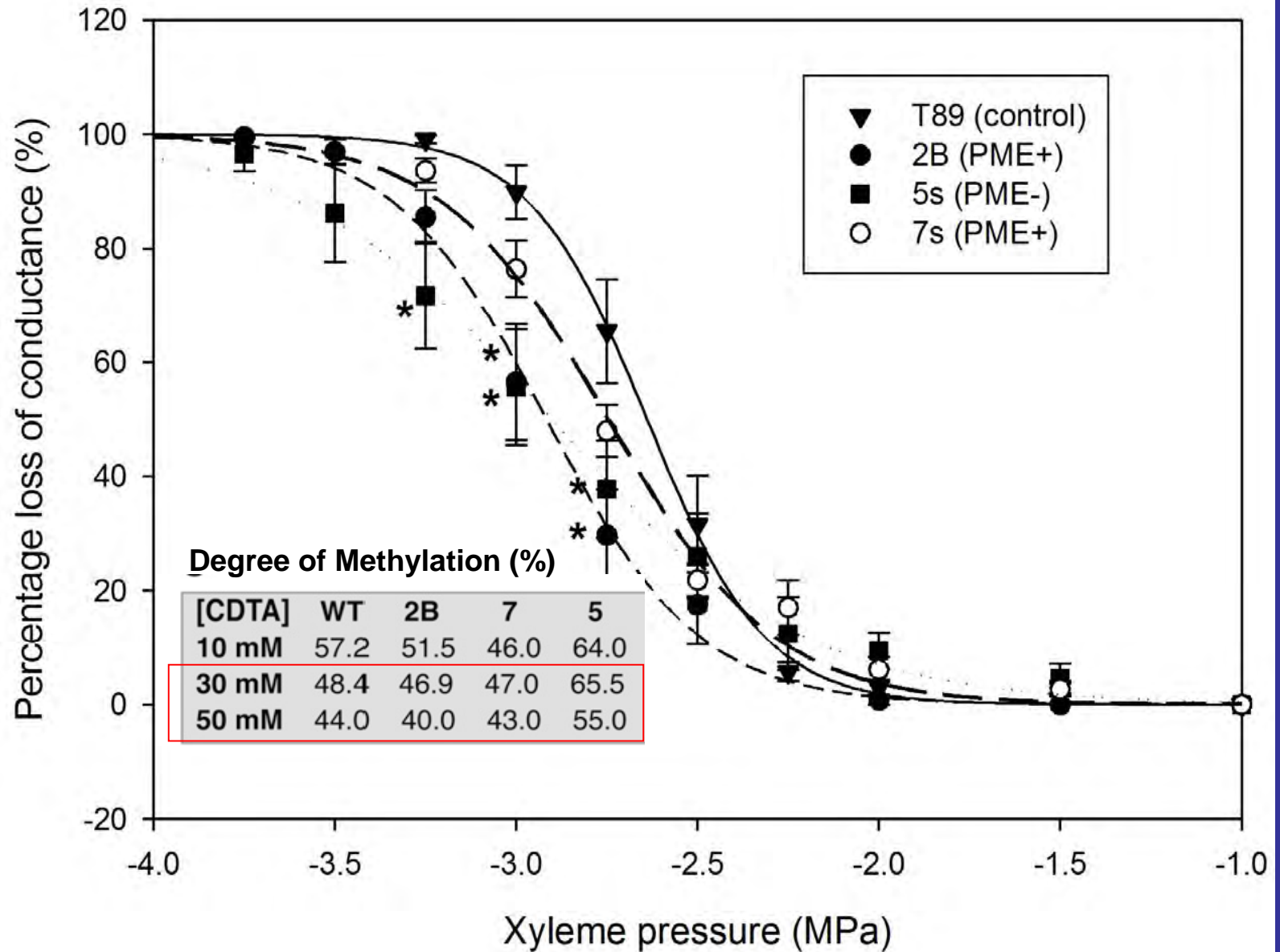

**Increase or decrease in PME causes a decrease in VC**

# Conclusions :

- ✓ Xylem Calcium is responsible for a major part of the between species variability for VC.
- ✓ It would not be involved in the phenotypic plasticity within species
- ✓ PME over- and under-expression increases the VC

# Perspectives :

-Investigate the xylem structure and pit membrane structure and composition in poplars over- or under-expressing PME.

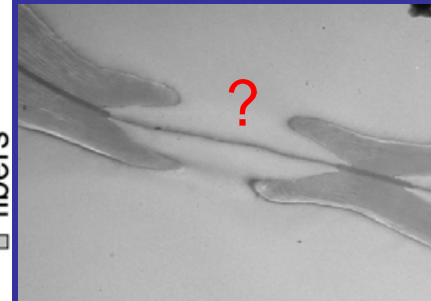
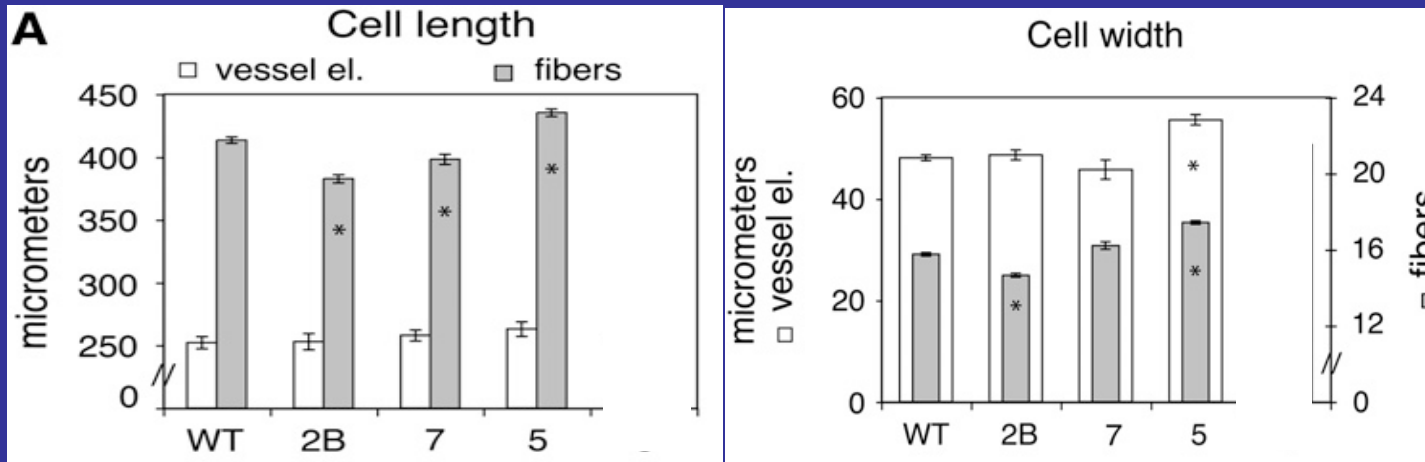



Thanks for your attention

# The contribution of gene expression studies on searching the genetic control of VC ?

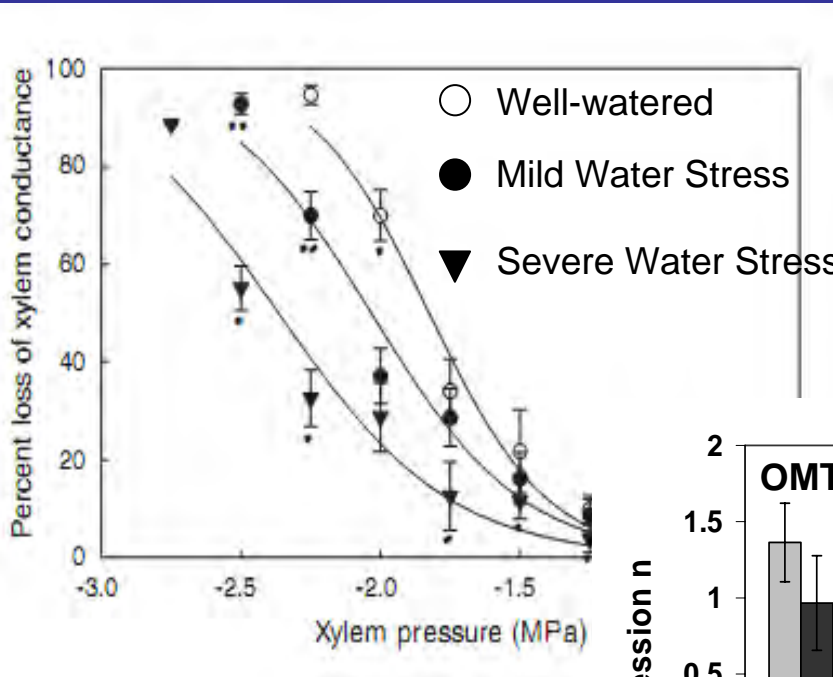

**The Classical investigations of gene expression are not suitable to identify gene of the VC.**

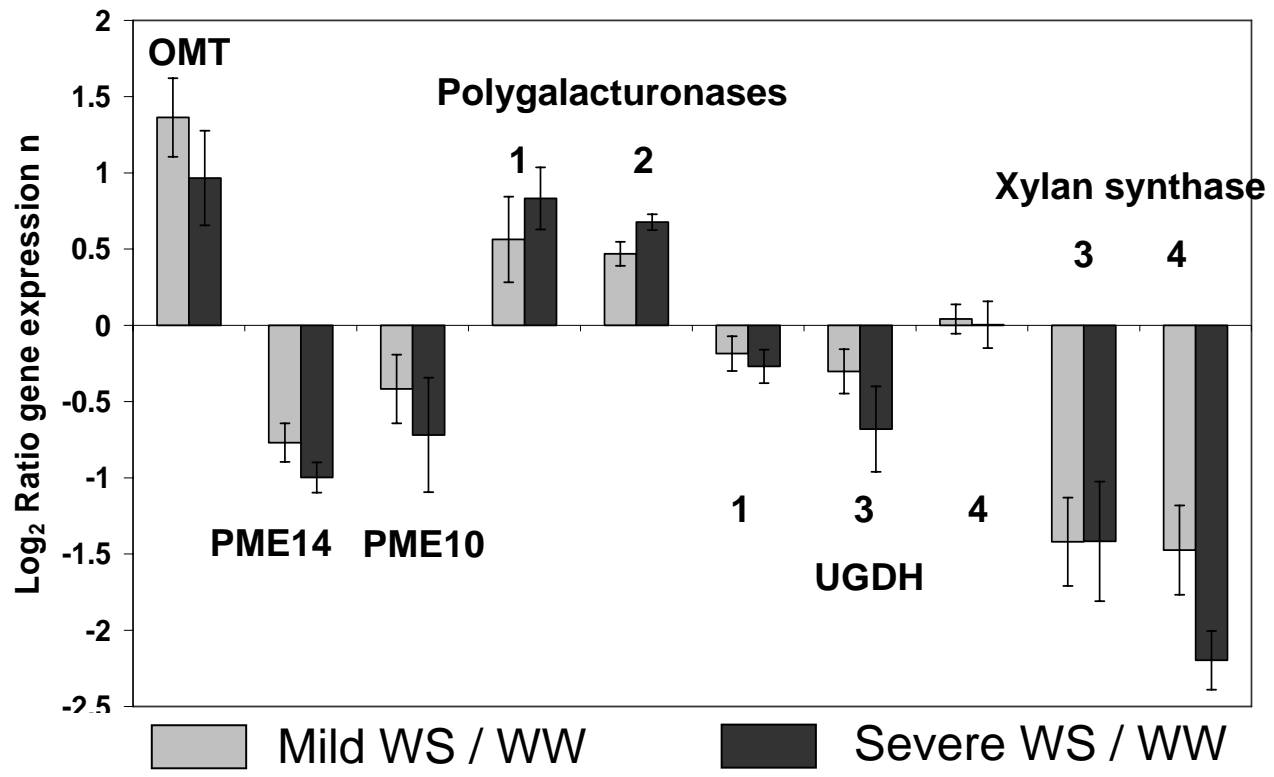

(Willats et al. 2001)

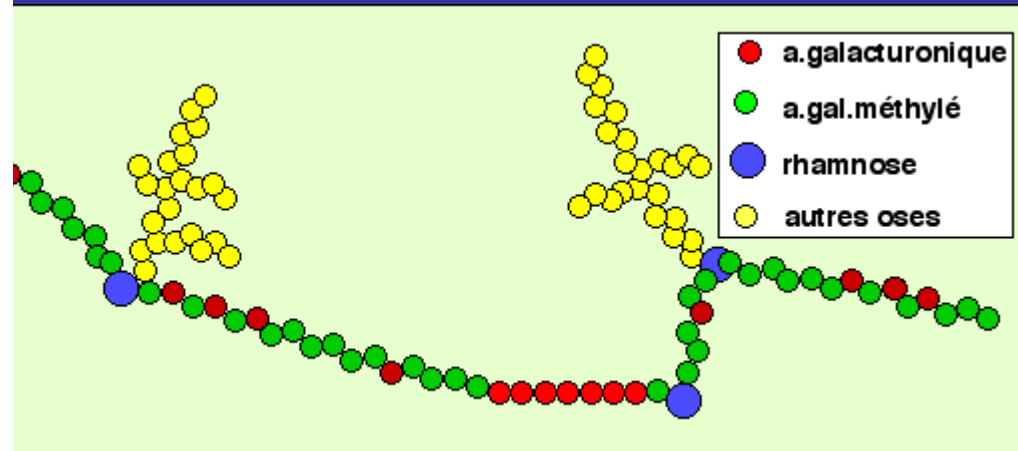
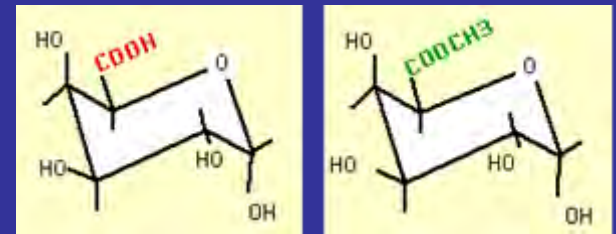
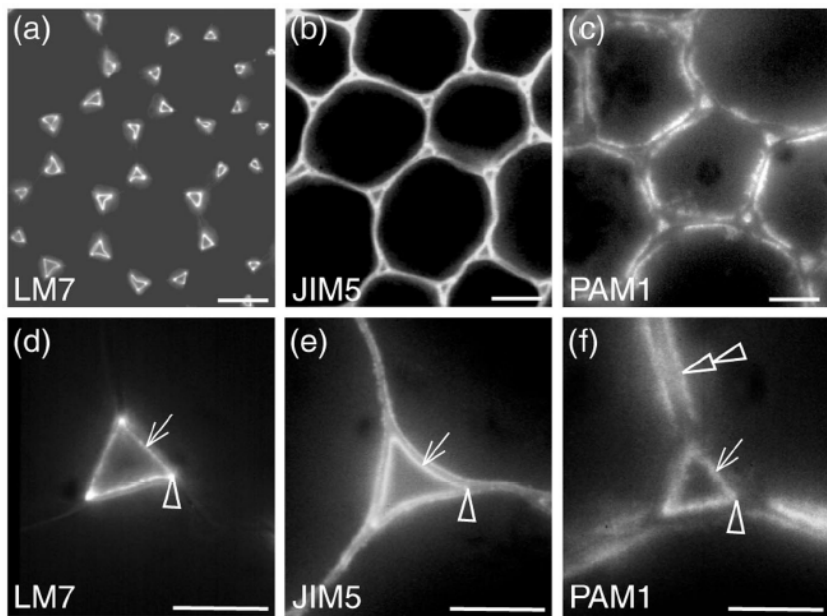

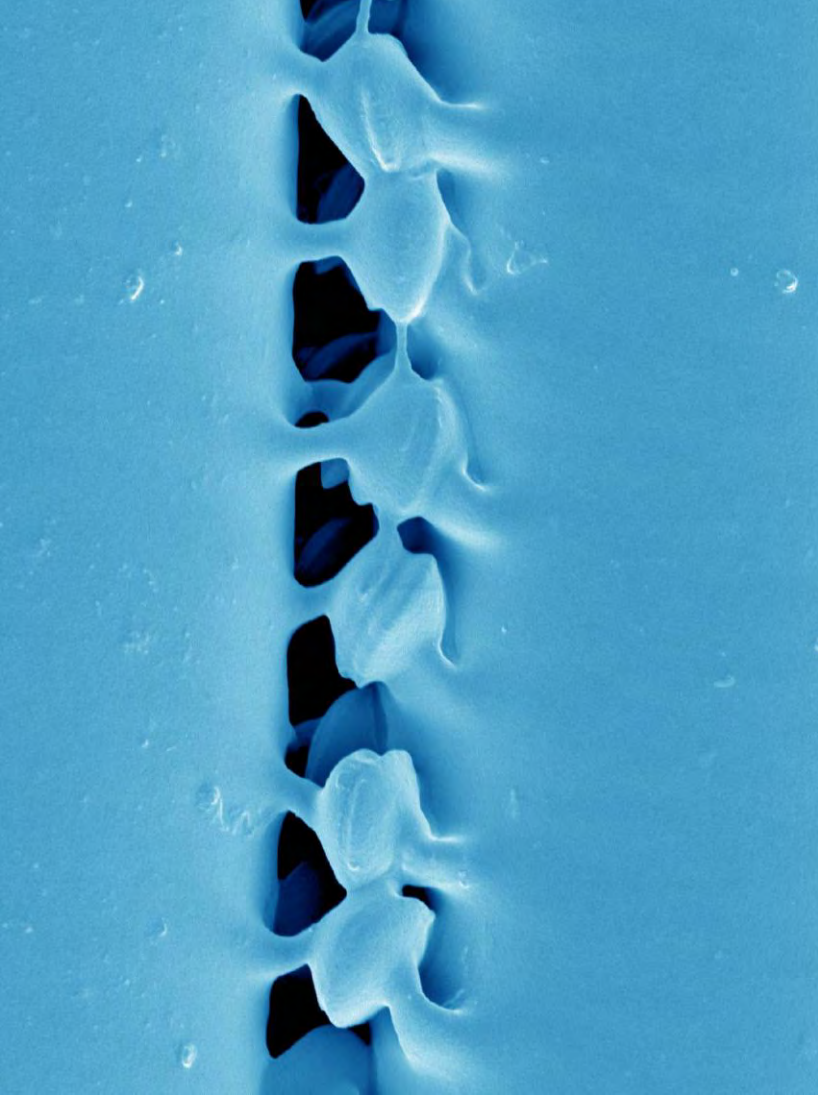

# La structure et la fonction des ponctuations aréolées dans le réseau hydraulique de plantes

**Steven Jansen**

Institute for Systematic Botany and Ecology



**Tracheids  
(unicellular)**

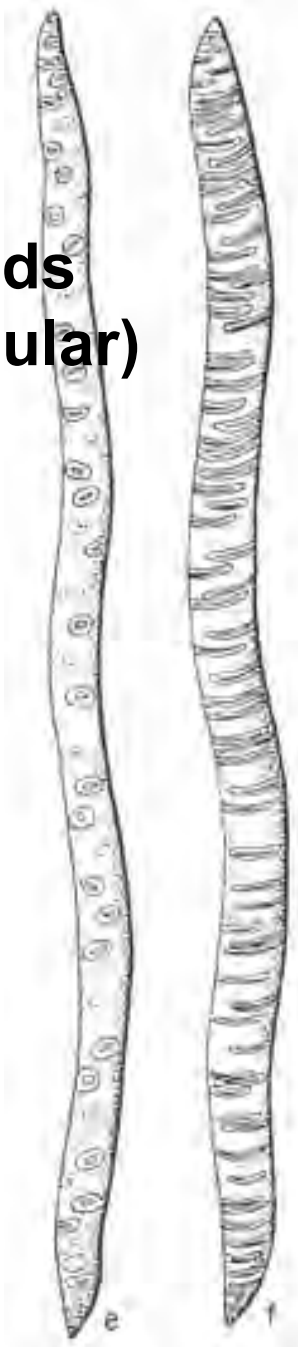

**Vessel elements with a  
scalariform - simple  
perforation plate**

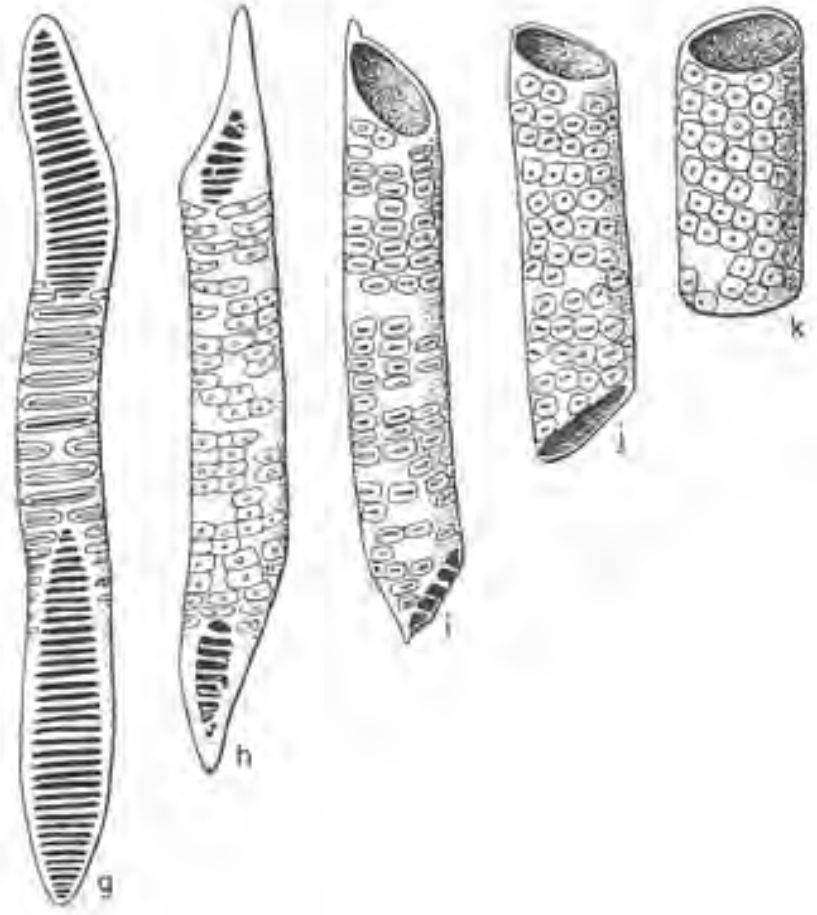

**Vessels  
(multicellular)**



*Meryta  
tenuifolia*



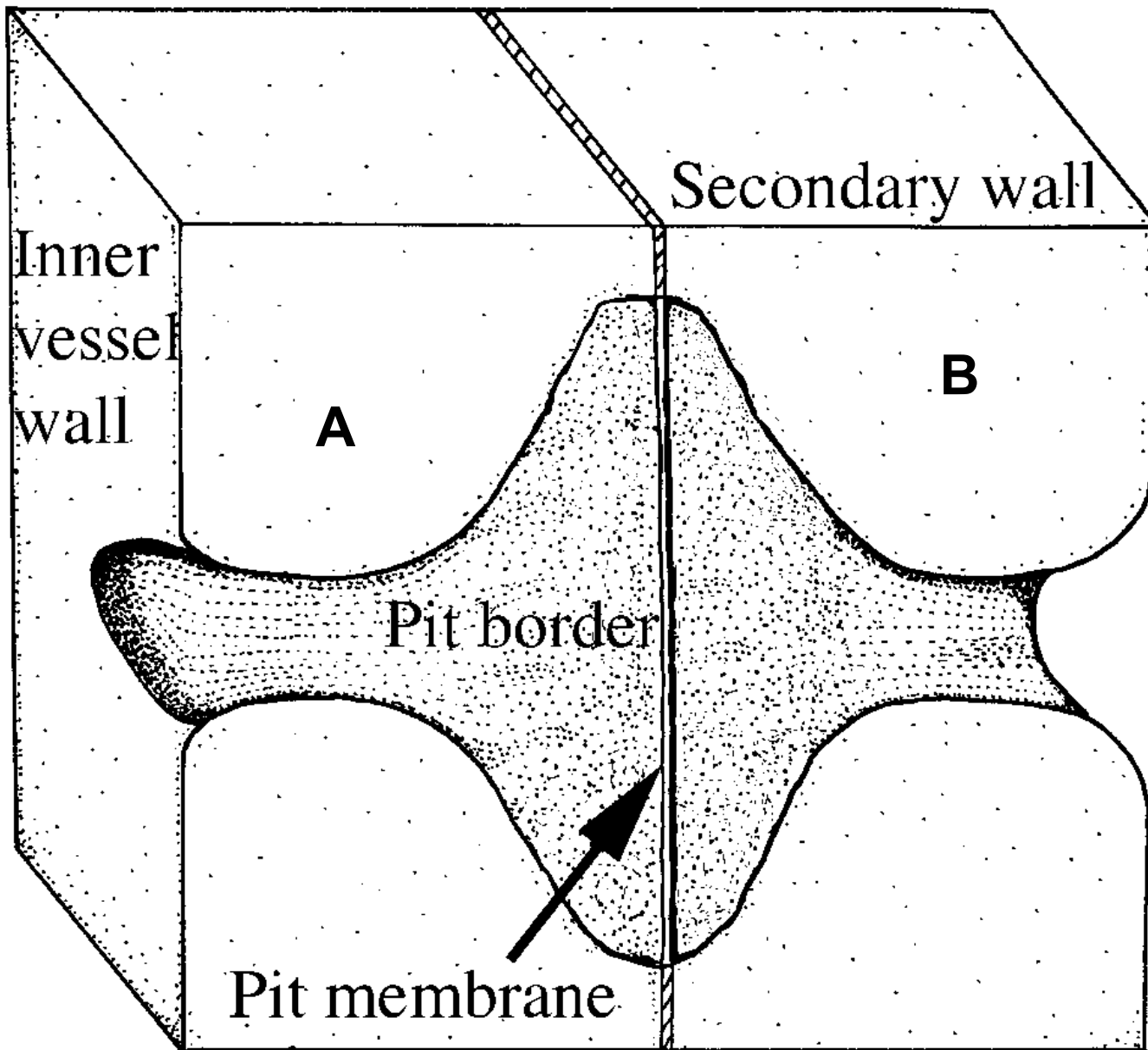
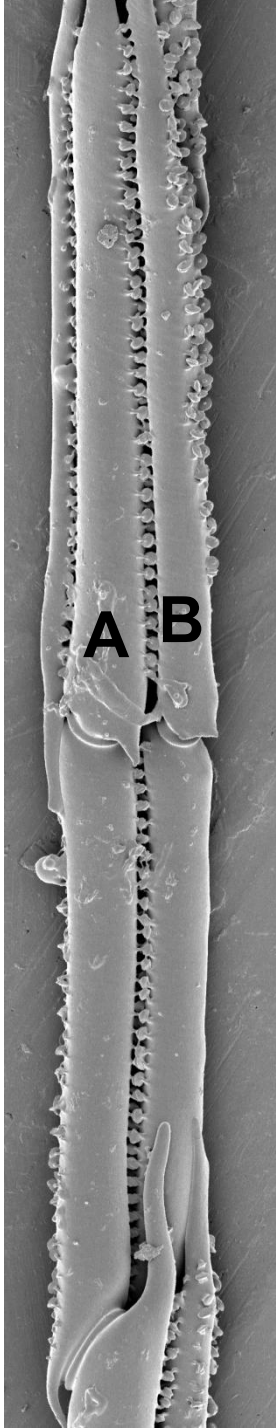

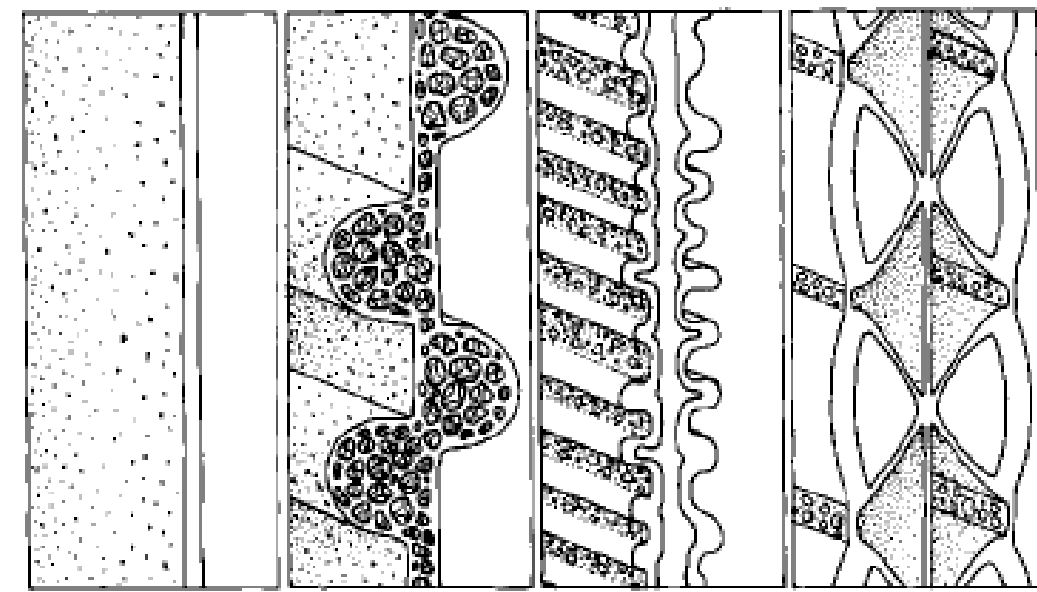
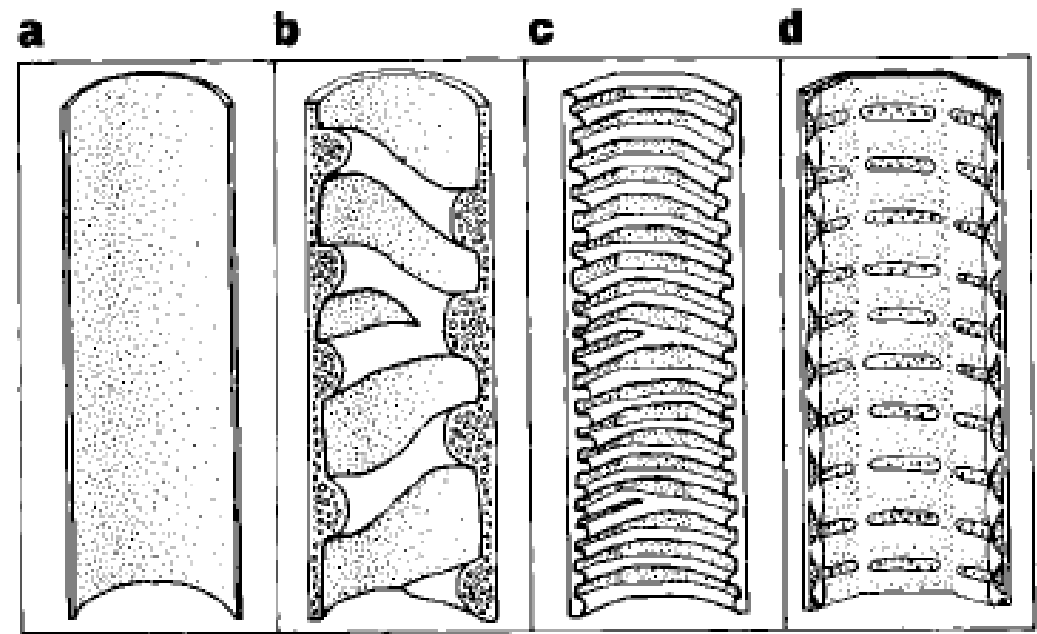

(g) From: Kenrick & Crane (1997); Friedman & Cook (2000); Pittermann (2010)

# Pit membranes

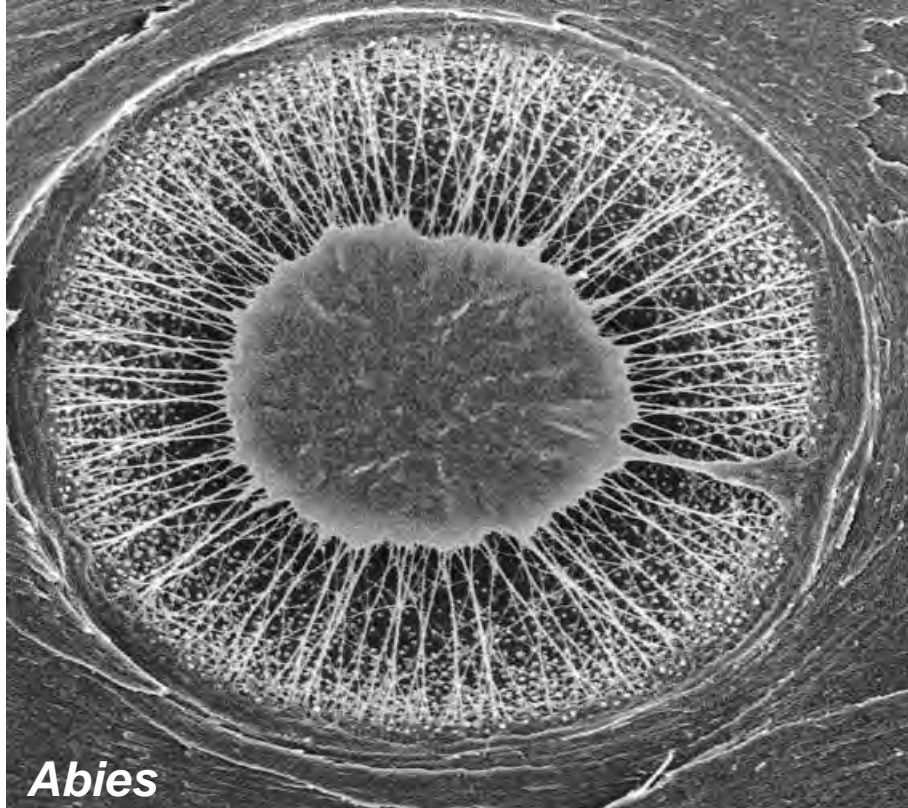

**Gymnosperms –  
torus-margo**

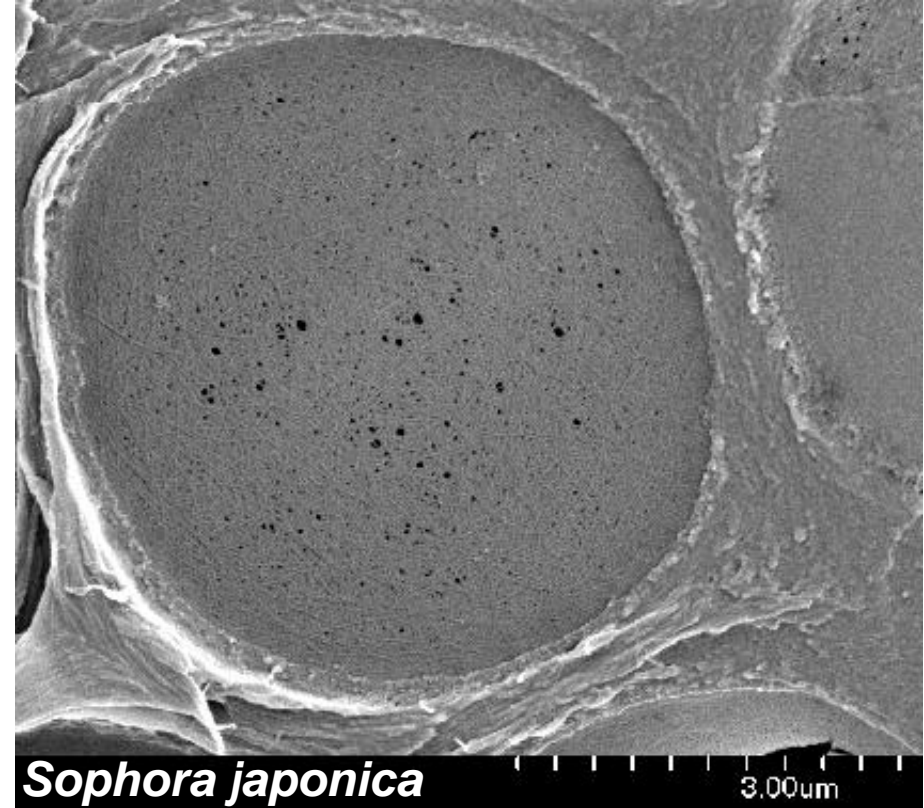

**Angiosperms –  
homogeneous pit membrane**

# Partitioning of vascular resistance

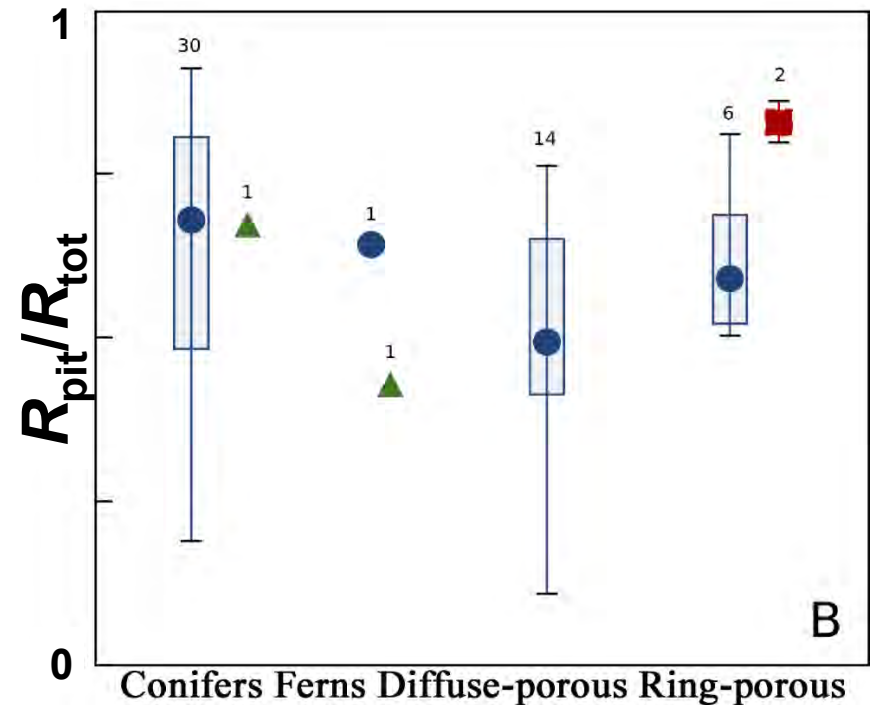
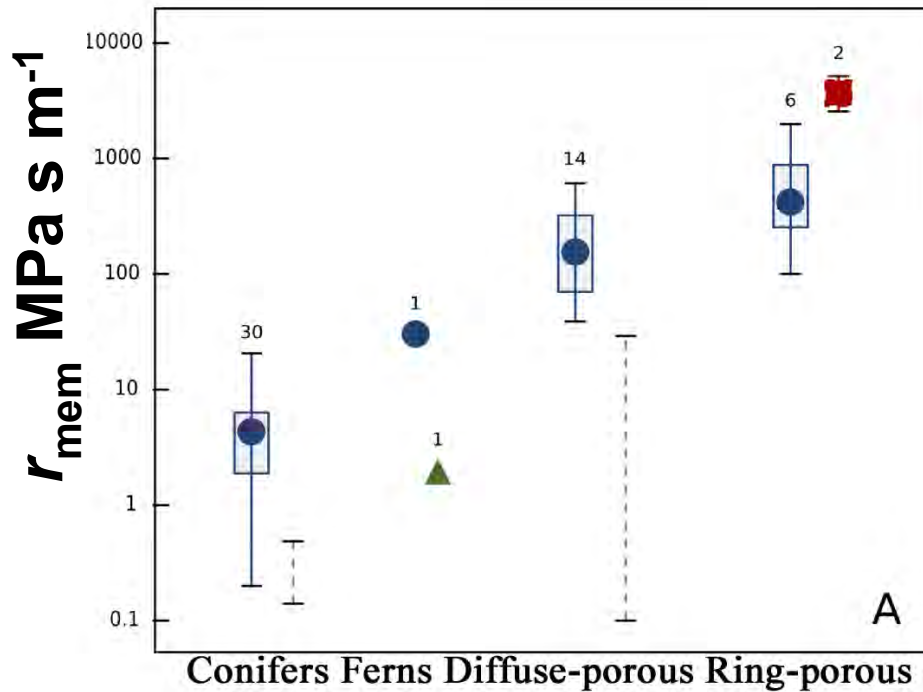

Choat, Cobb & Jansen (2008)

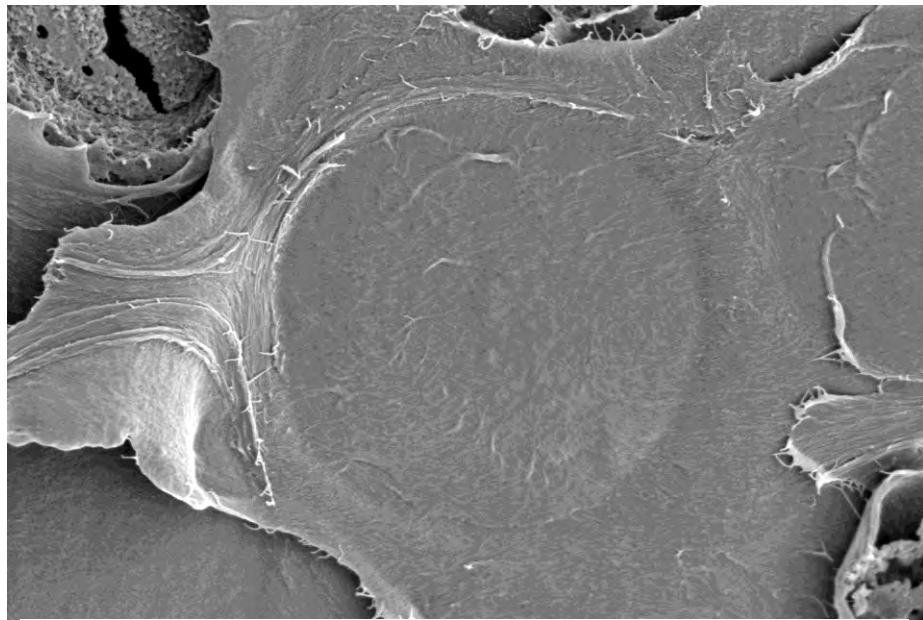

***Laurus nobilis***

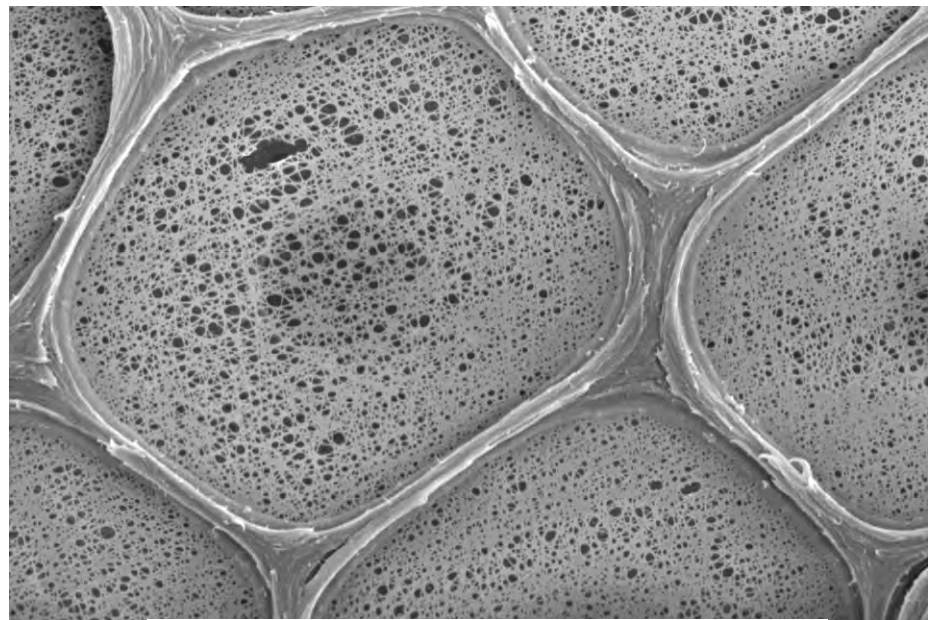

S4700 2.0kV

***Salix alba***

1 μm

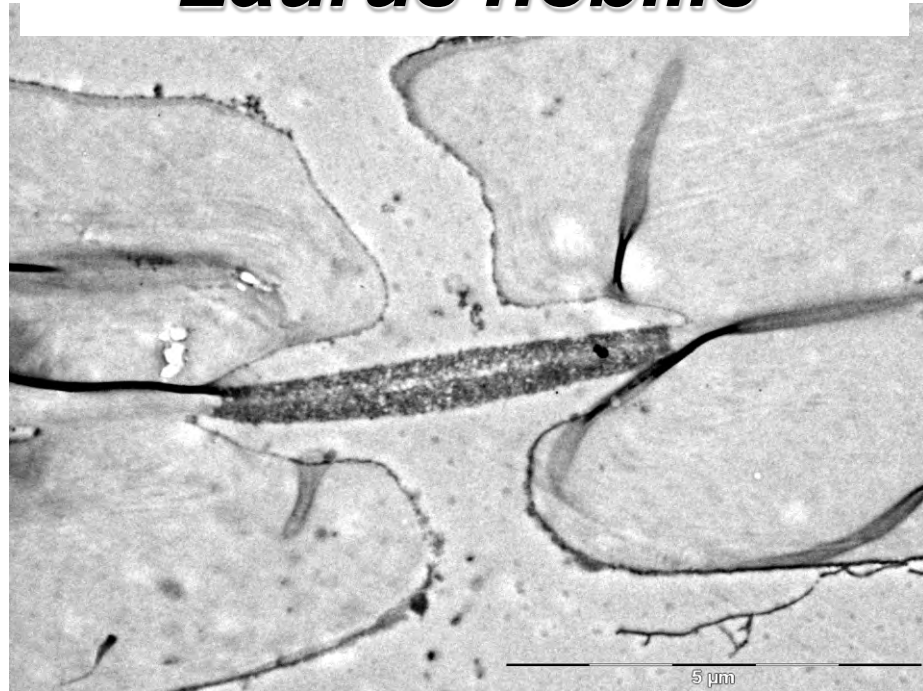

5 μm

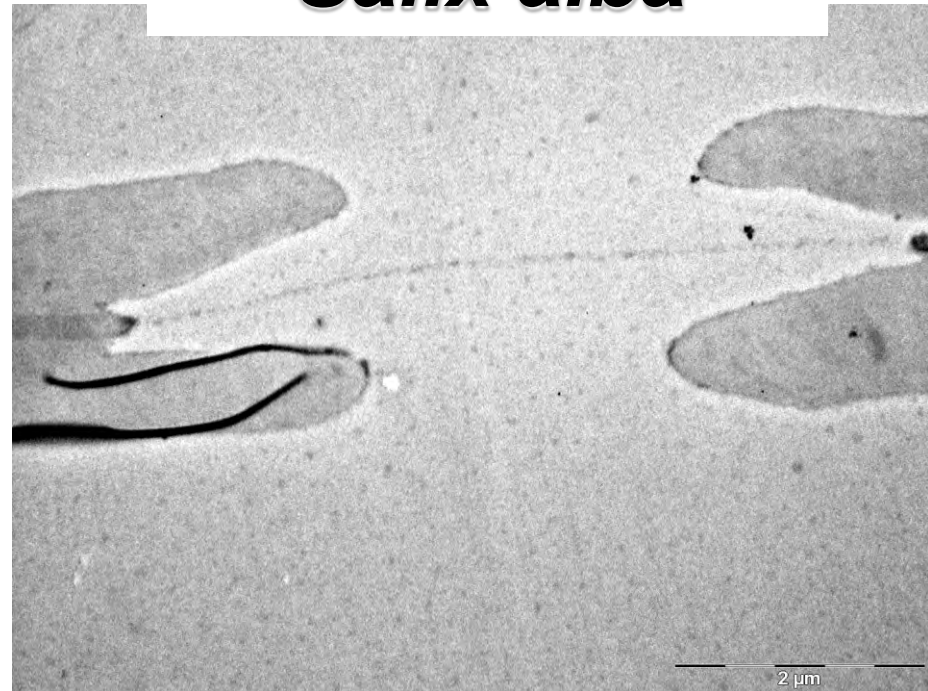

2 μm

*Tetracentron sinense*

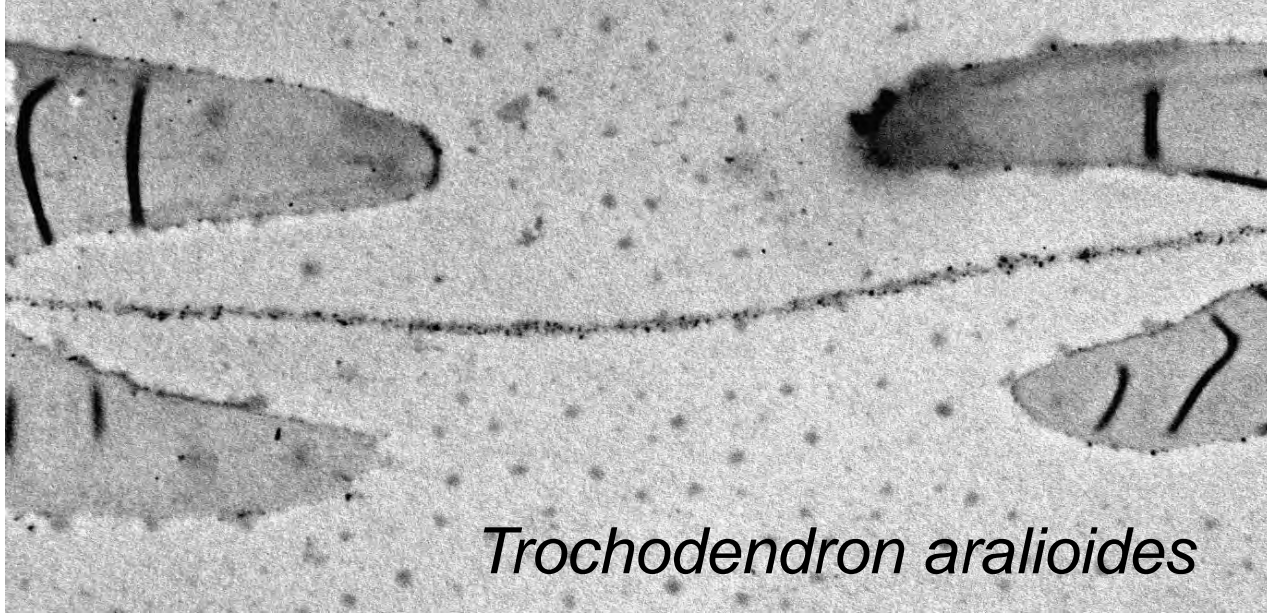
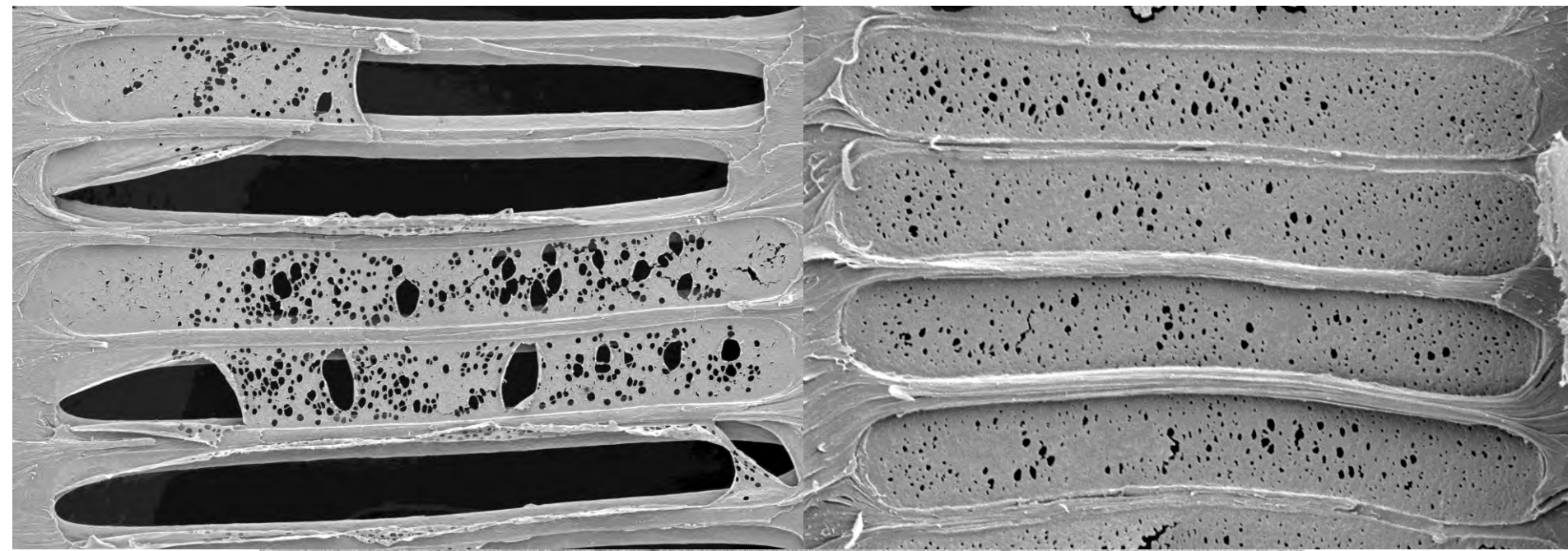

*Trochodendron aralioides*

## Freezing-induced cavitation

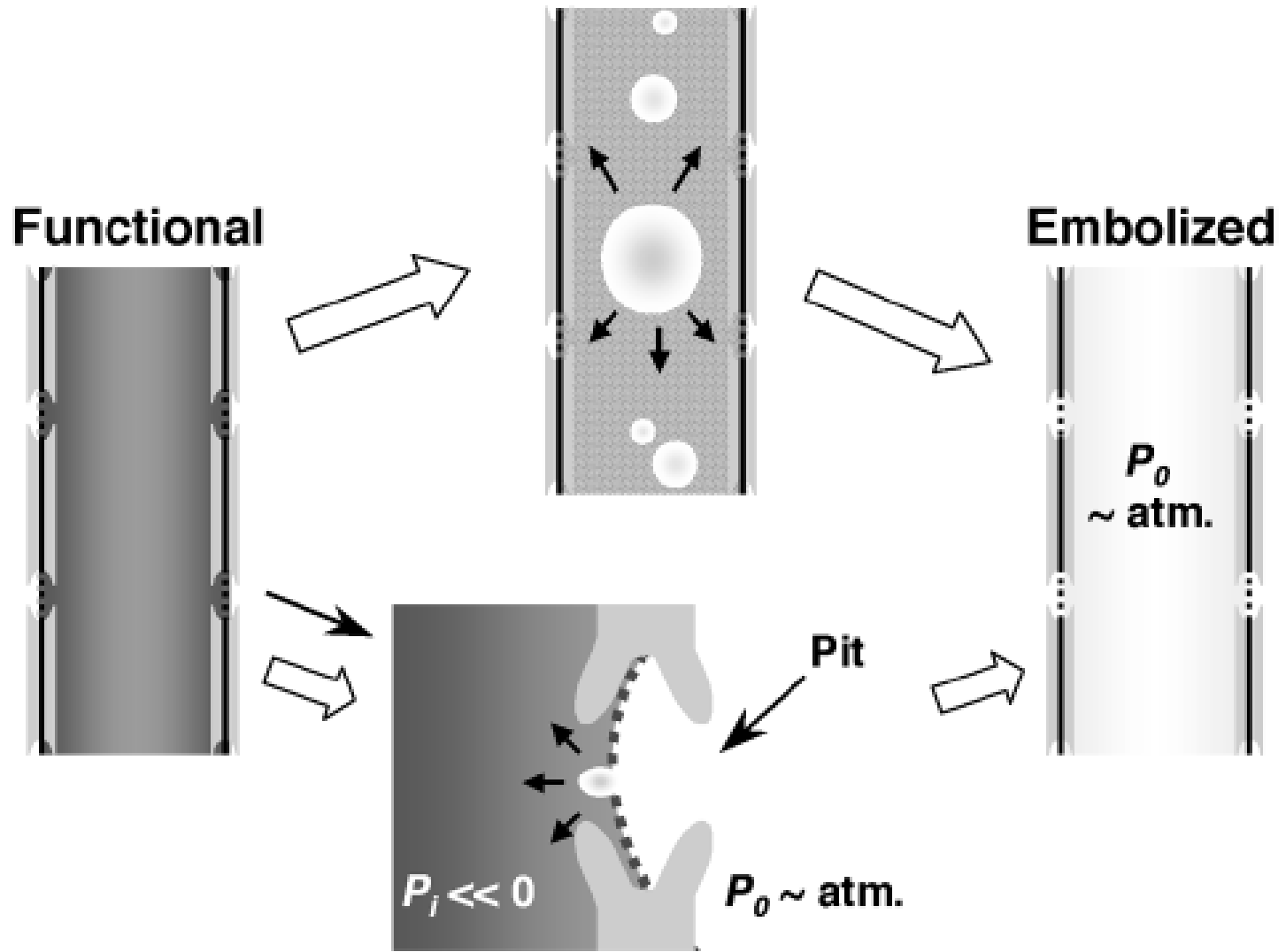

## Drought-induced cavitation

Hacke & Sperry (2001)

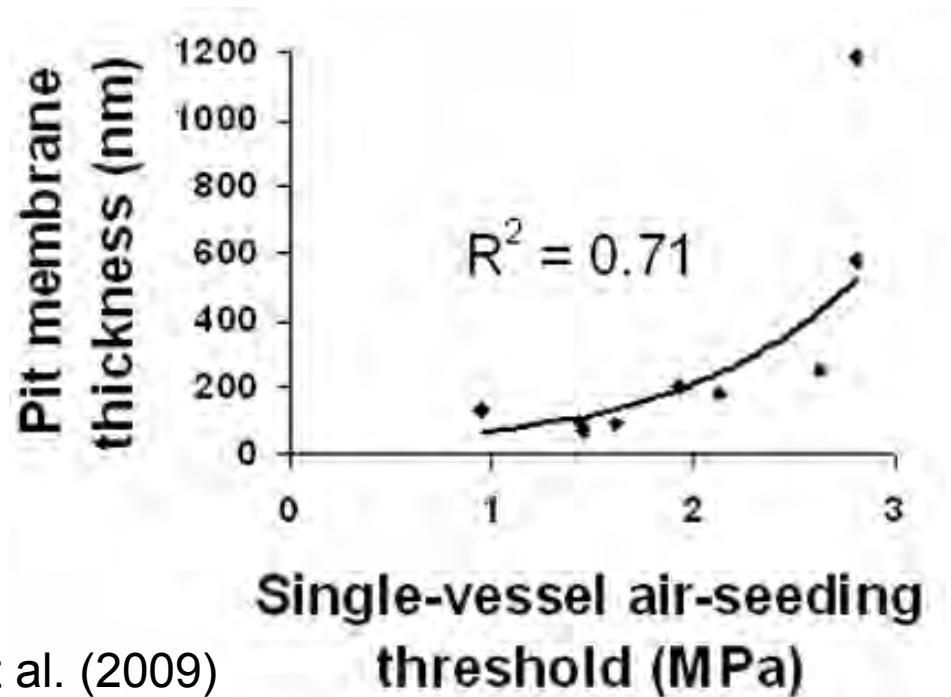
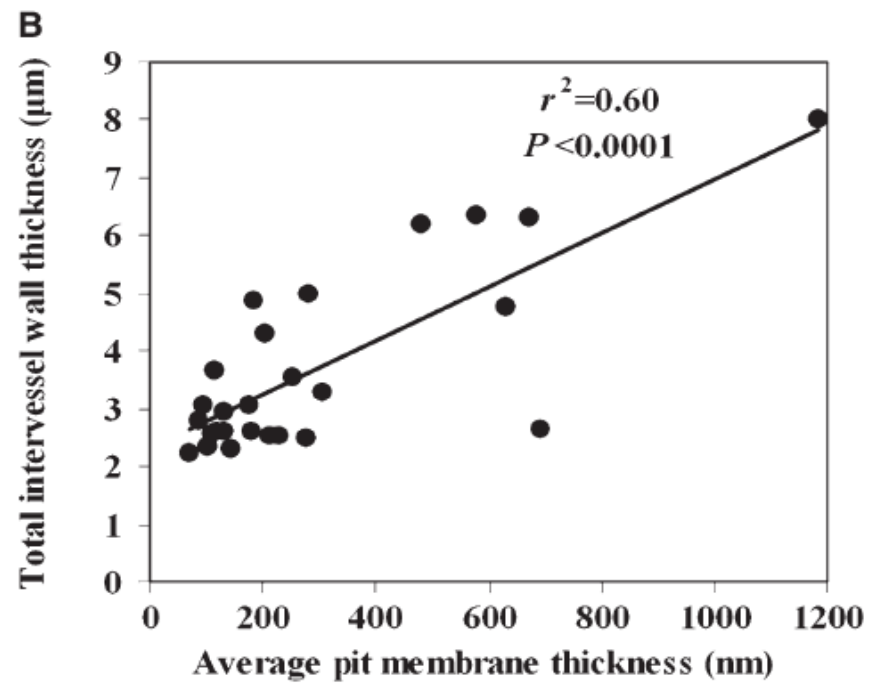
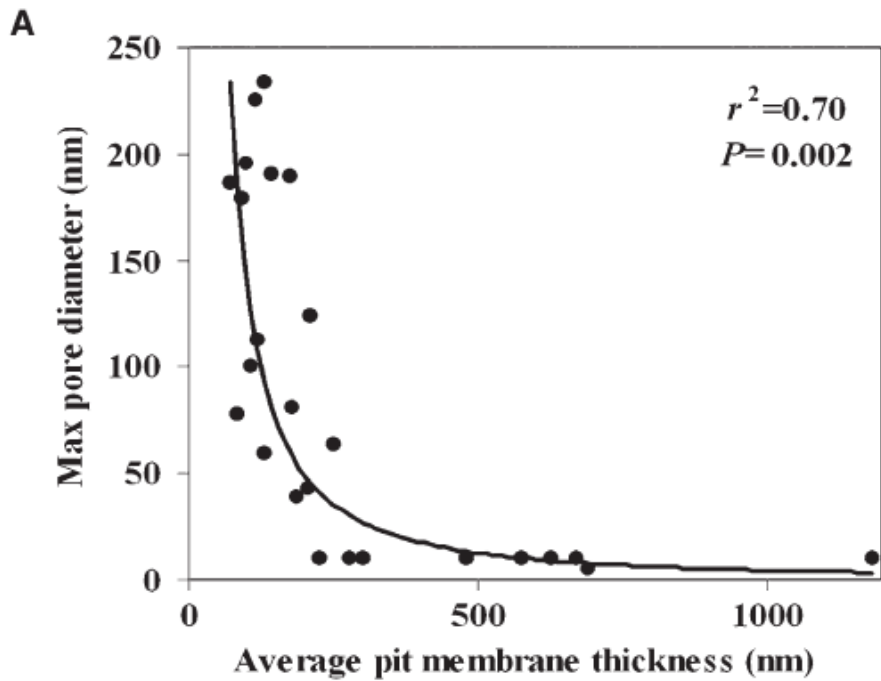

Jansen et al. (2009)



# Intervessel pit membrane thickness vs. P50 in *Acer* and *Prunus*

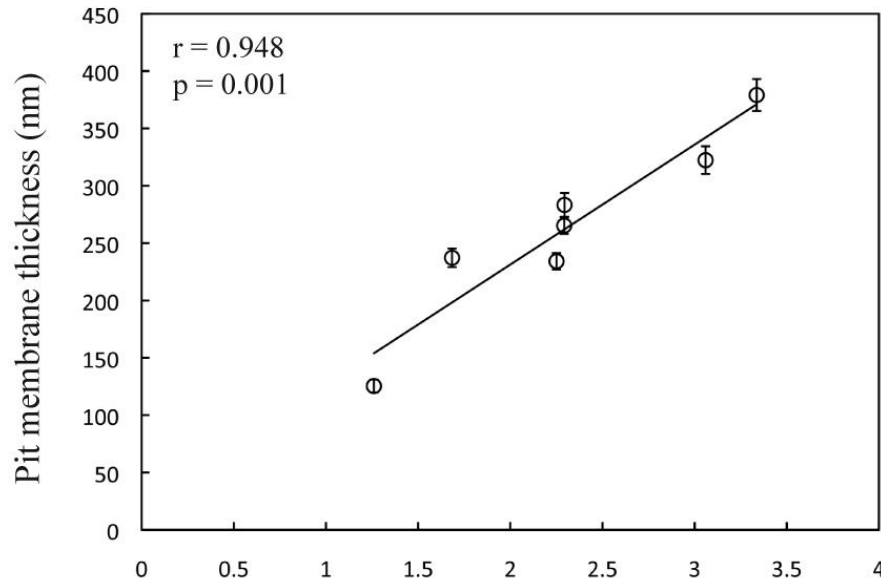

Lens et al. (In press)

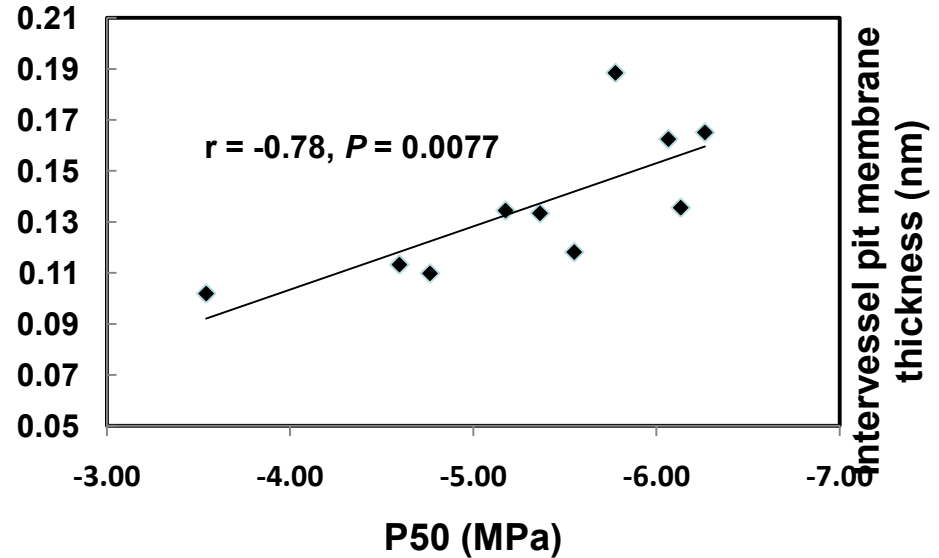

Rabaey et al. (unpublished)

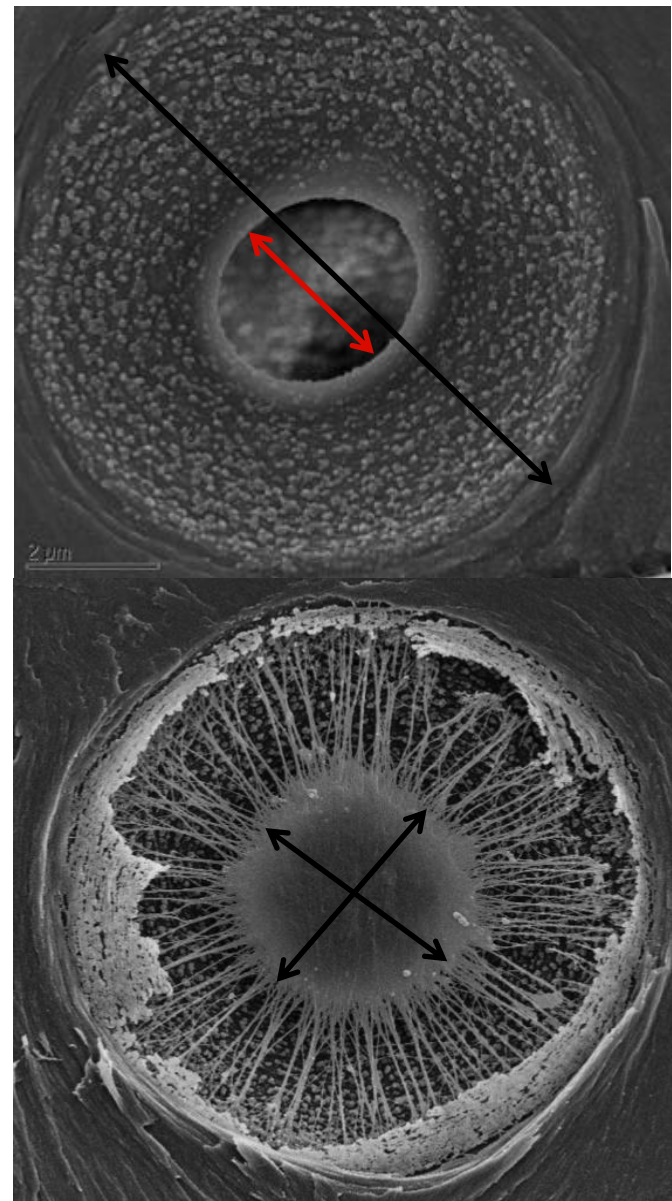
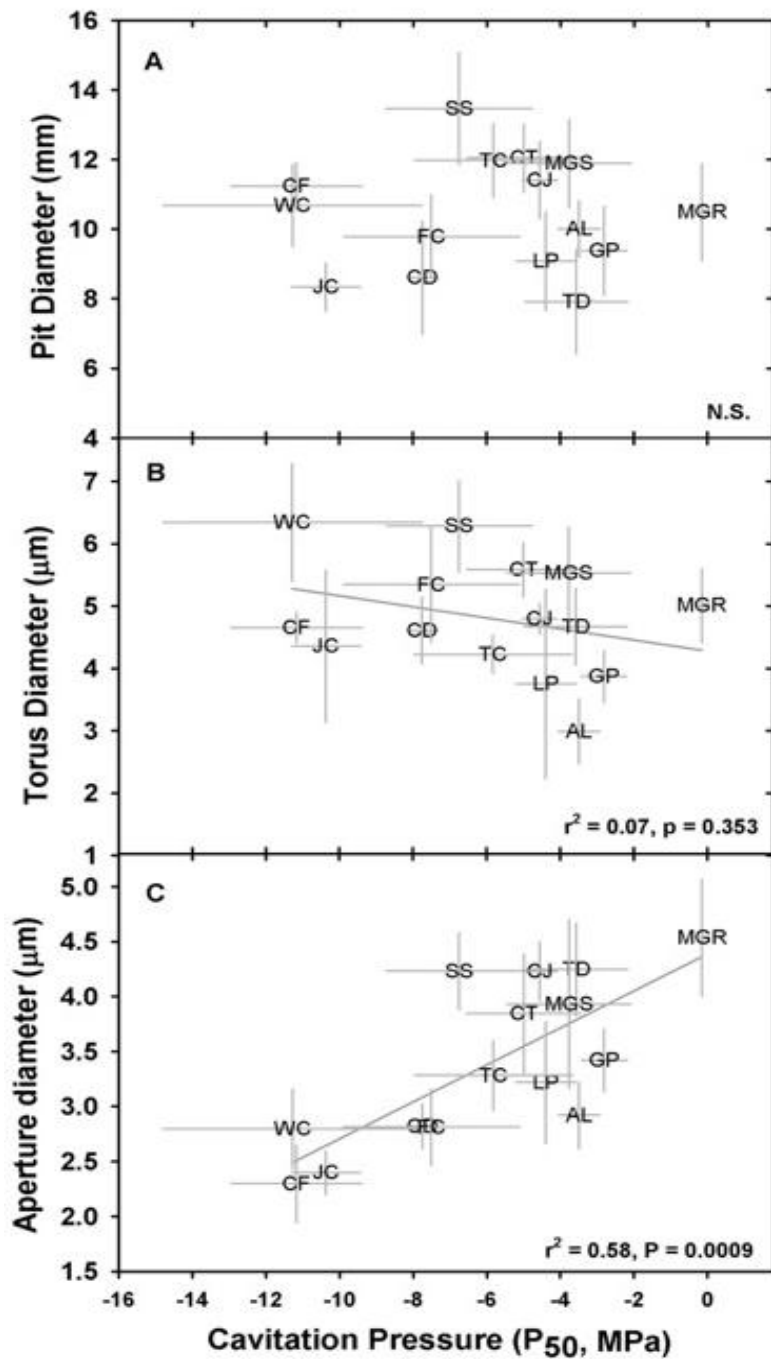

*Calocedrus decurrens*

Pittermann et al. (2010)

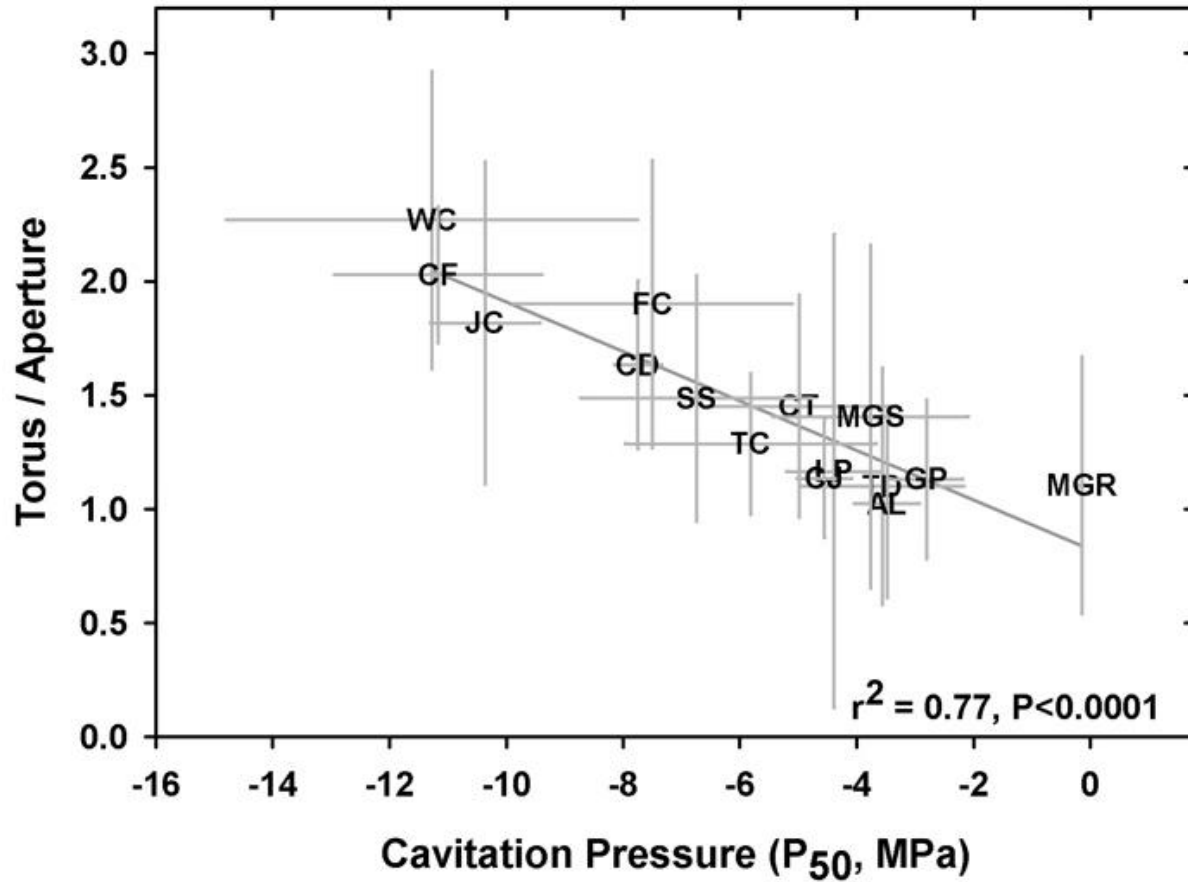

Pittermann et al. (2010)

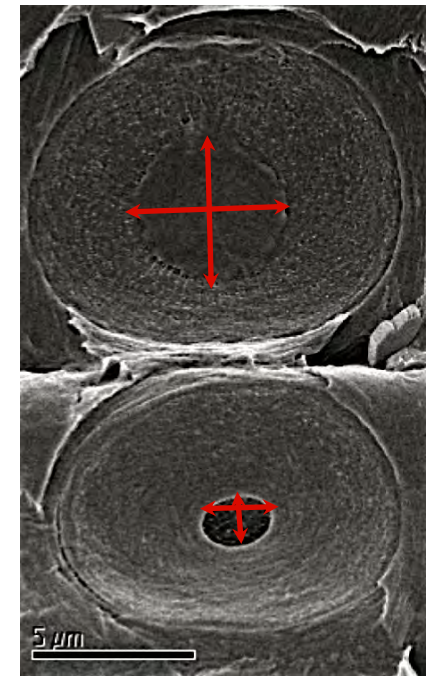

*Cupressus forbesii*

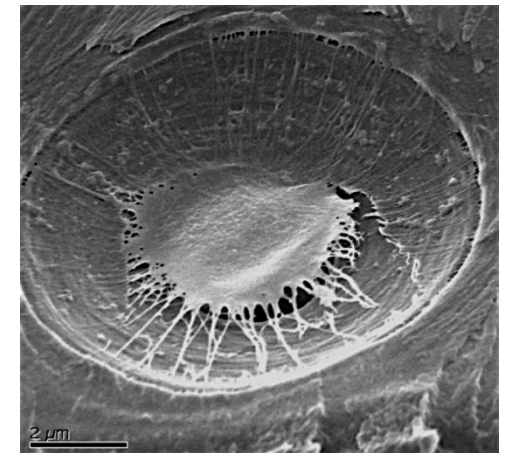

*Glyptostrobus pensilis*

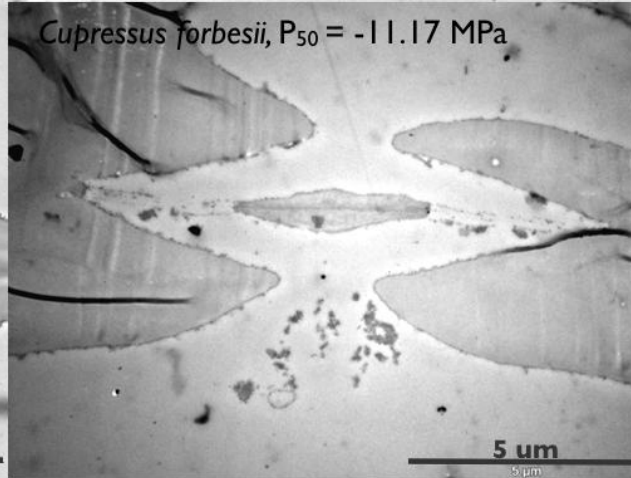
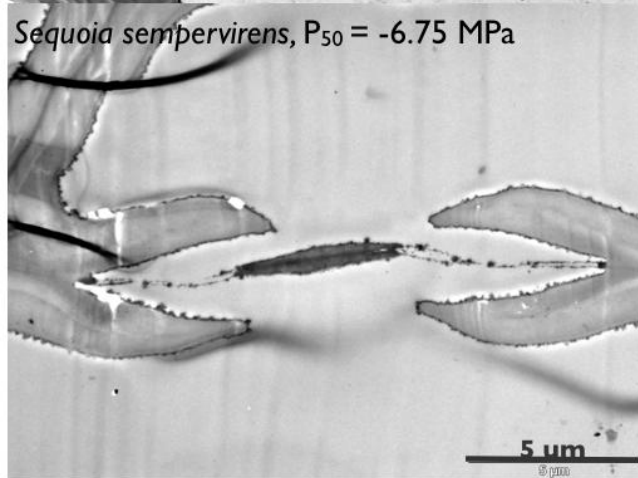
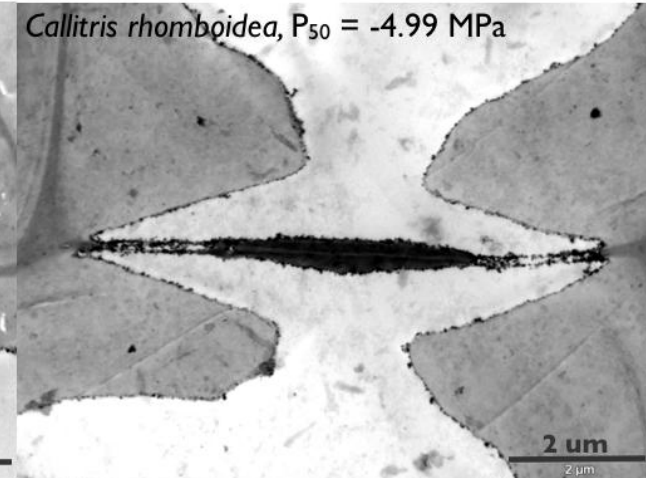
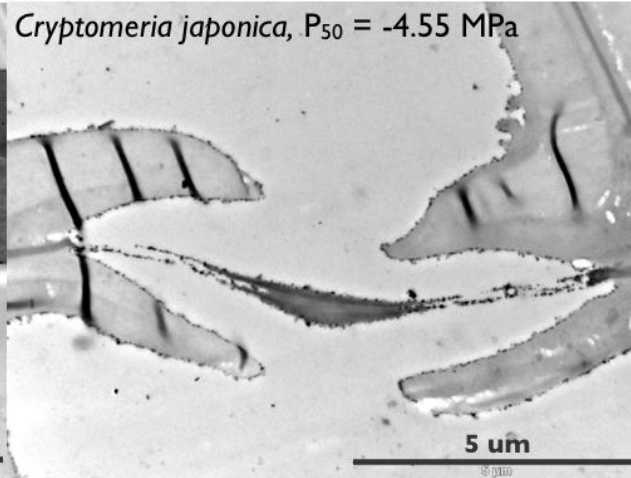
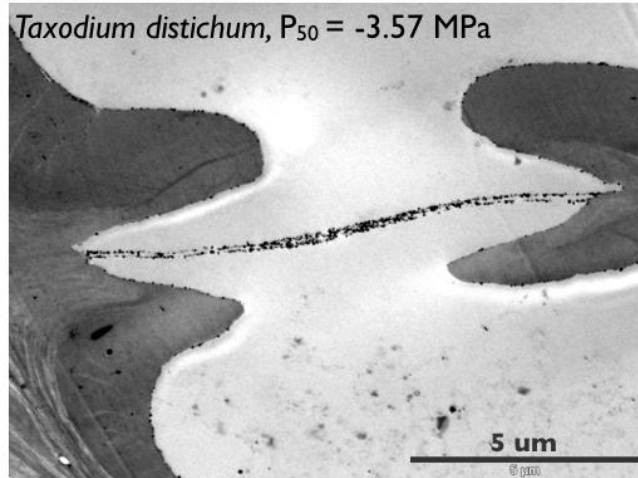

- Torus thickness: increases with more negative cavitation pressures
- Margo thickness: invariable across  $P_{50}$

Pittermann et al. (2010)

# How impermeable is the torus?

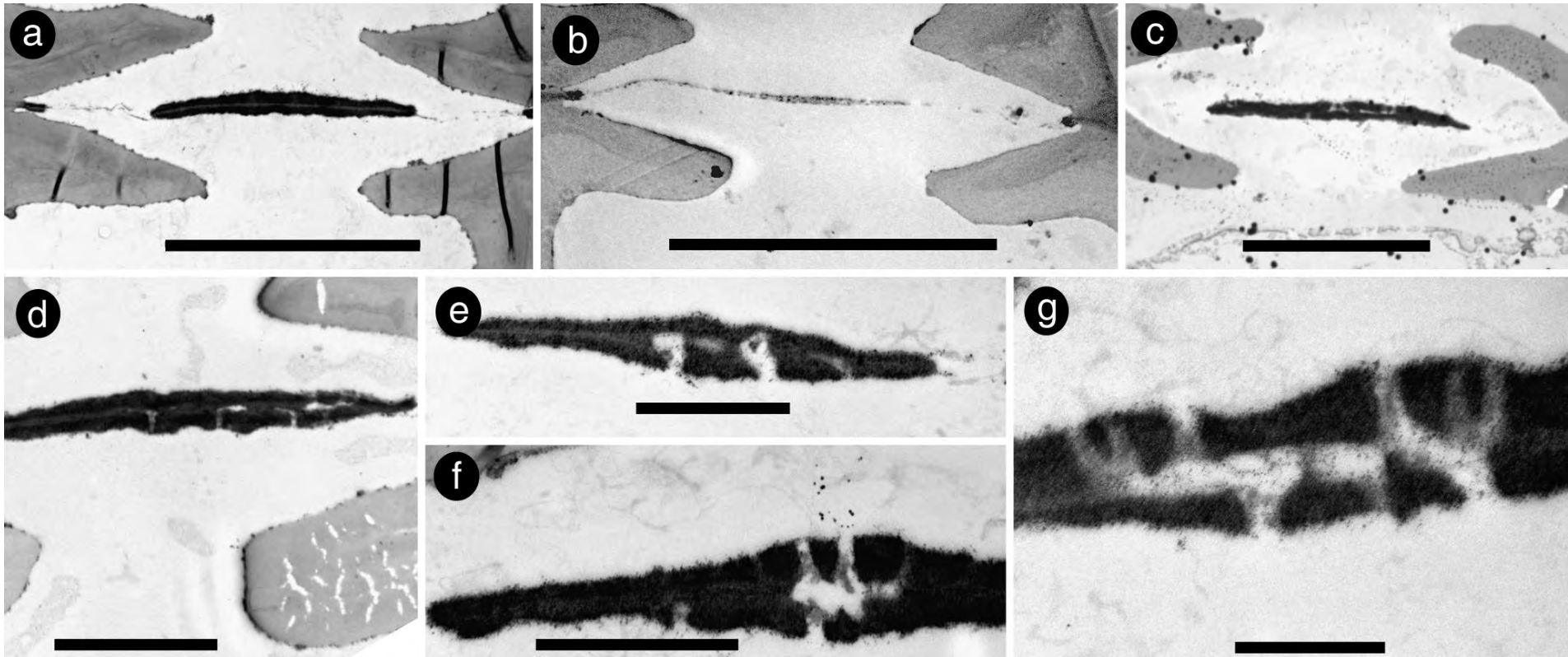

# Vestured pits



***Gynochtodes* sp.**  
**- Rubiaceae**

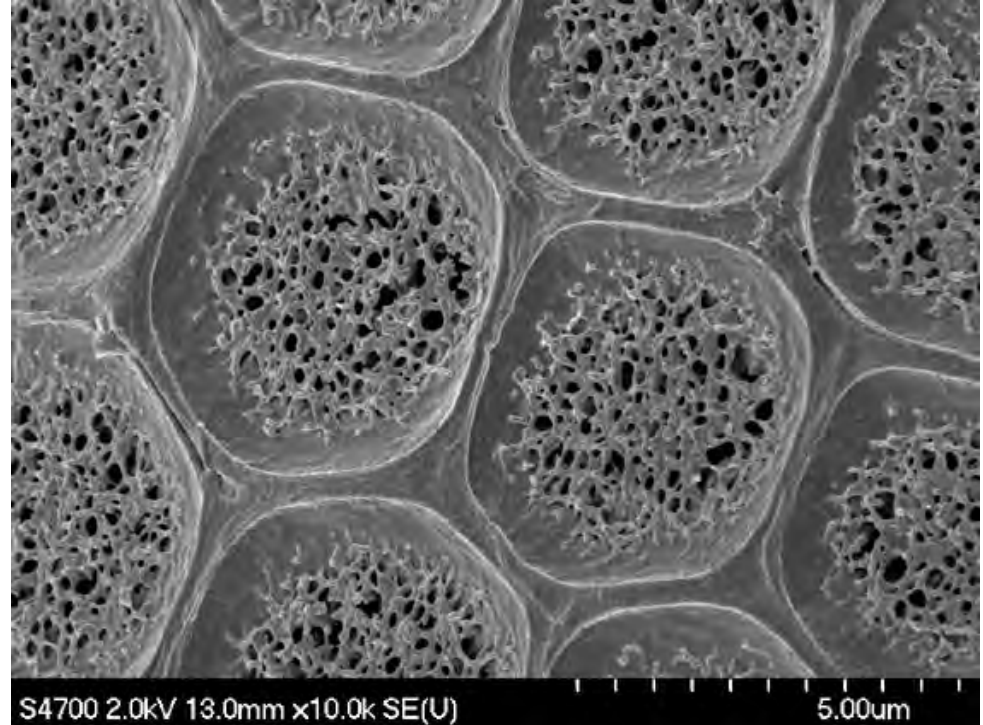

***Cleistocalyx ellipticus***  
**- Myrtaceae**

# Vestured pits in flowering plants

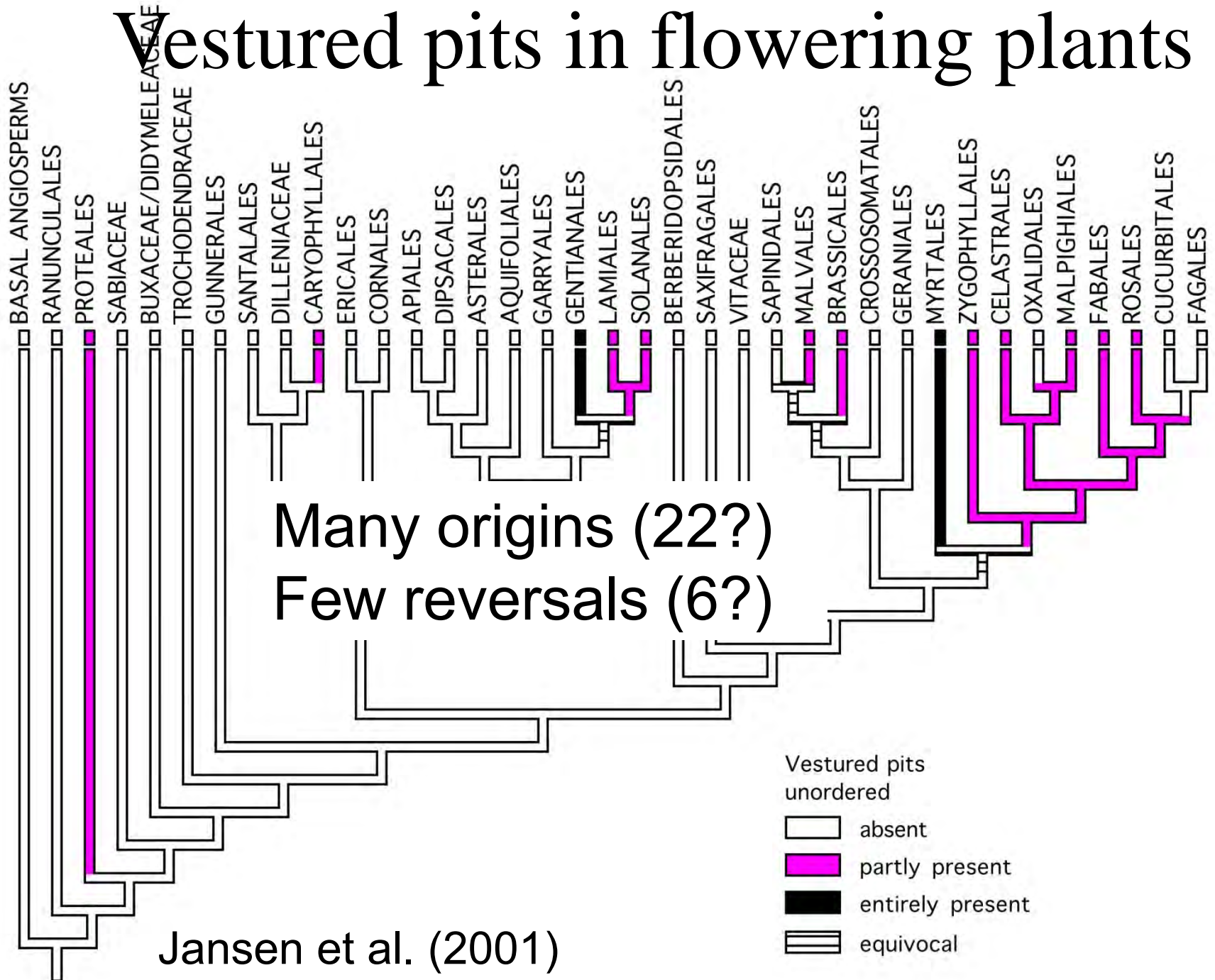

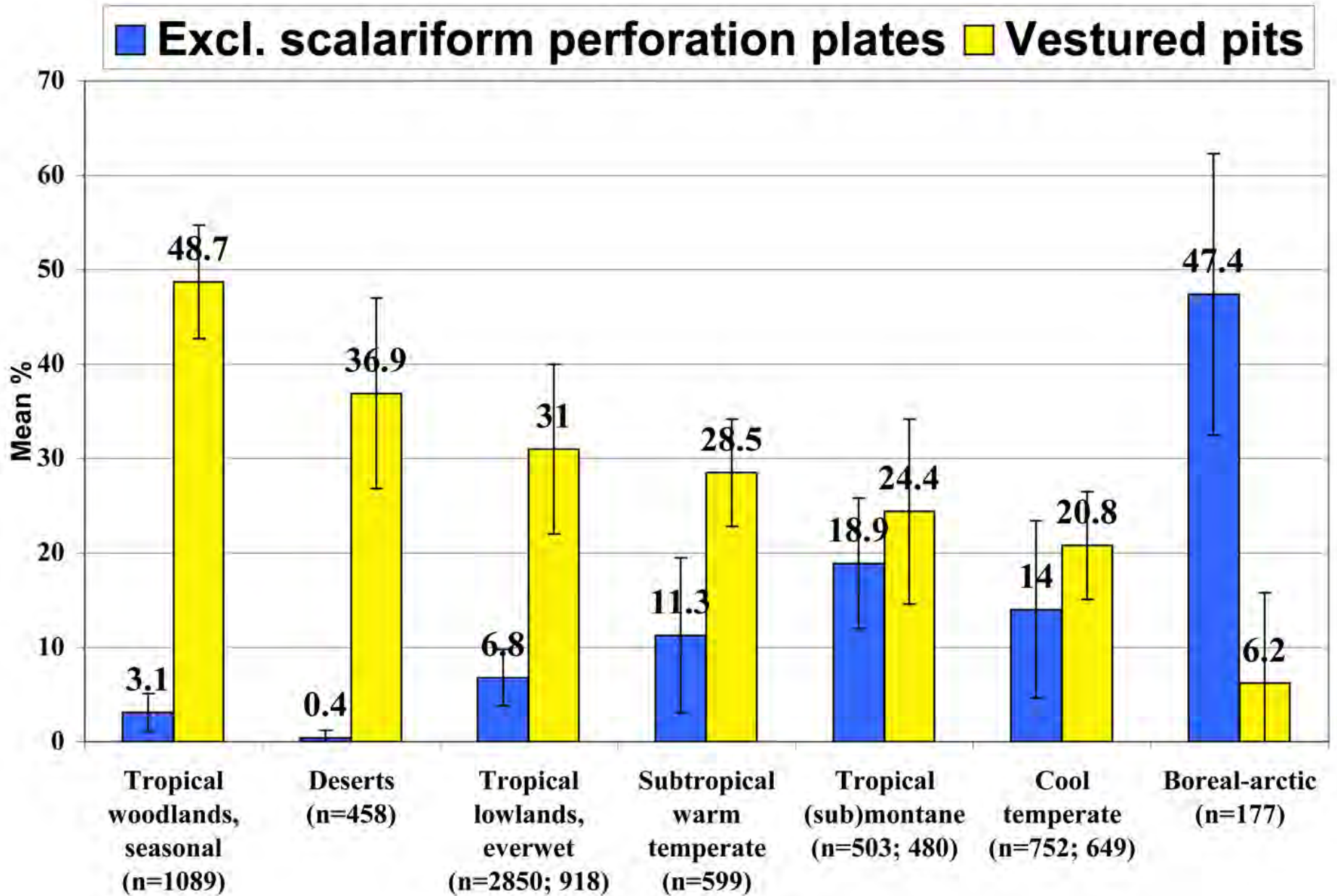



# Vestures reduce the probability of air-seeding

Choat et al. (2004)

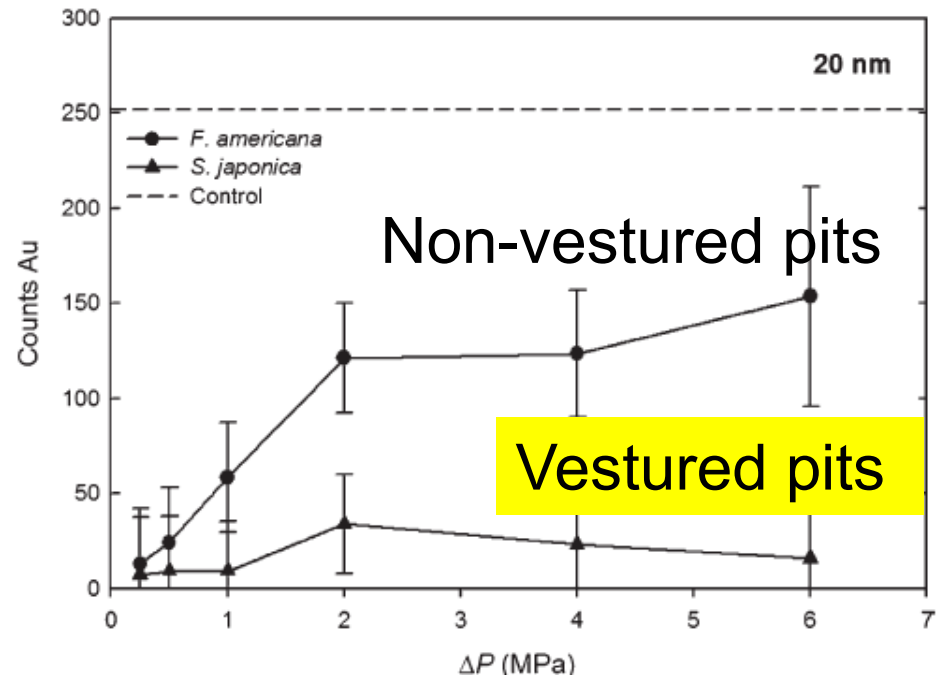
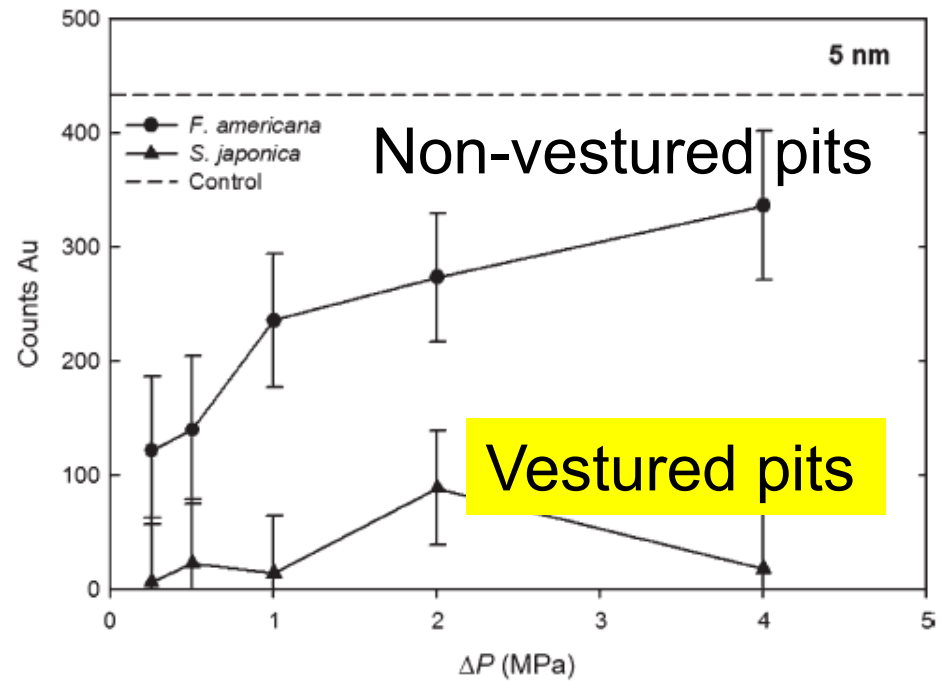
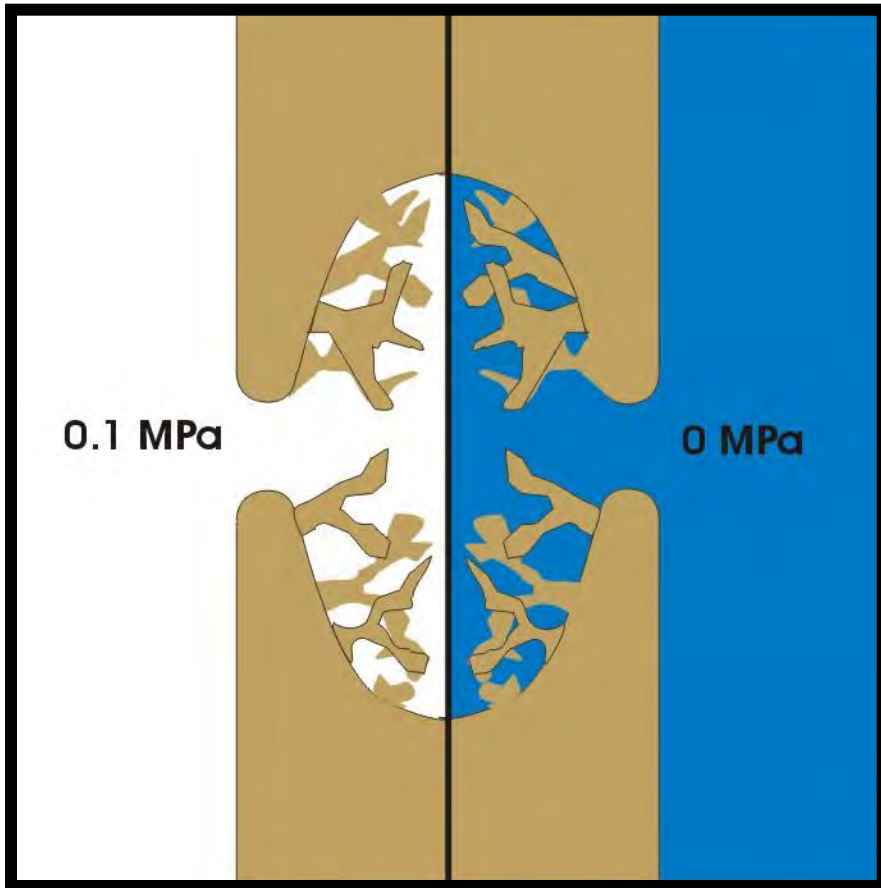

# 'Rare pit' hypothesis: pit quantity vs pit quality?

Vulnerability to cavitation depends on the **single largest pit membrane pore**

The largest pit membrane pore is influenced by **the total area of pits in a conduit**: the more pit area, by chance the larger the greatest pore (Wheeler et al. 2005).

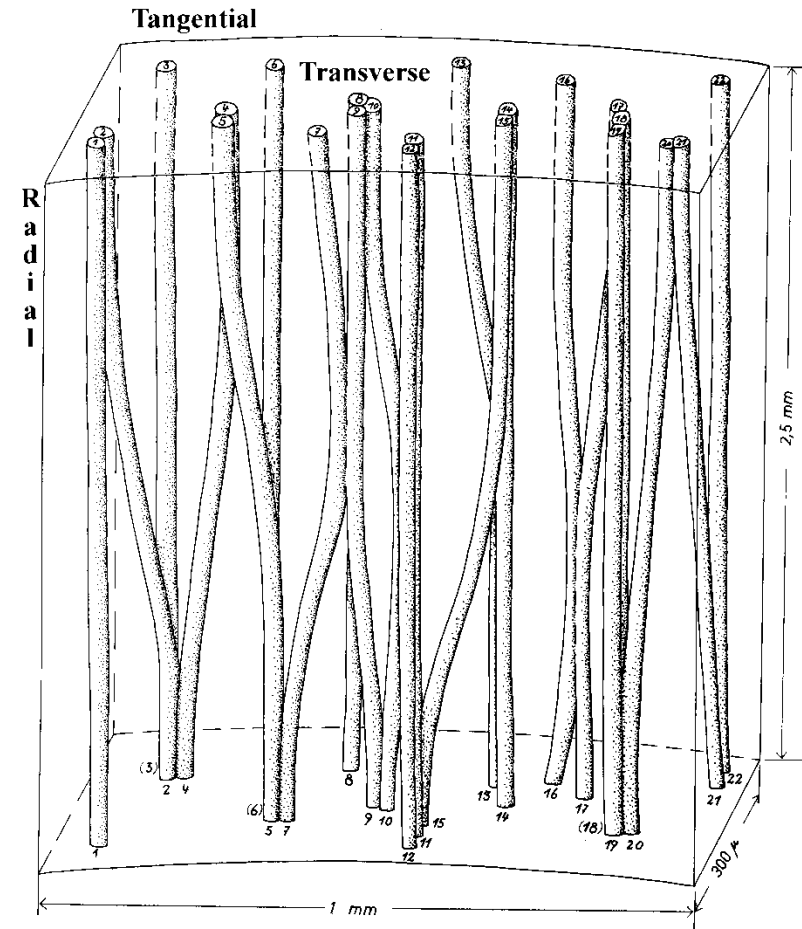

Braun 1959 – *Populus* vessel network

# Cavitation protection increases in conduits with less interconduit pit area

Hacke et al. (2006, 2007)

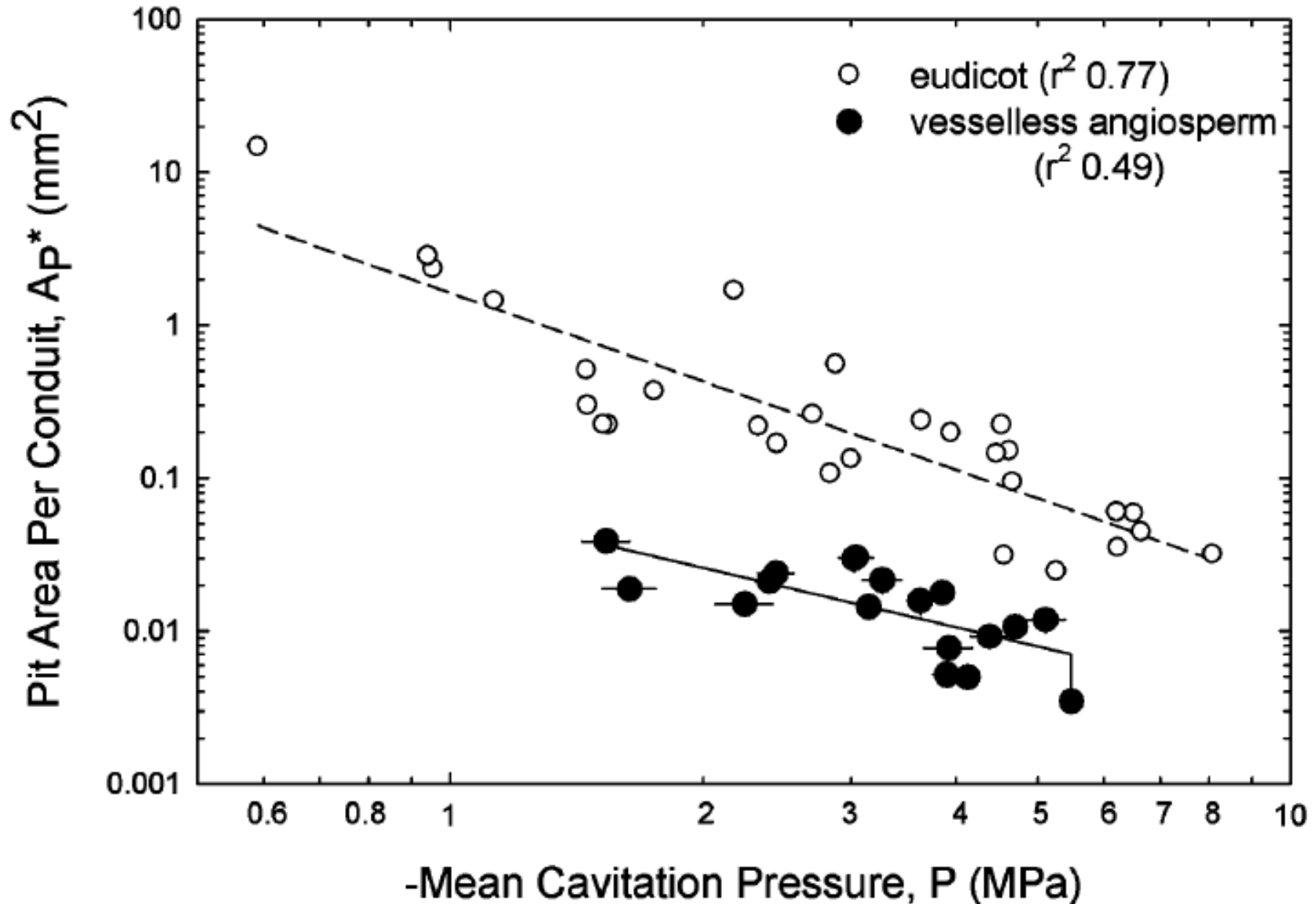

## The ionic effect is species-specific

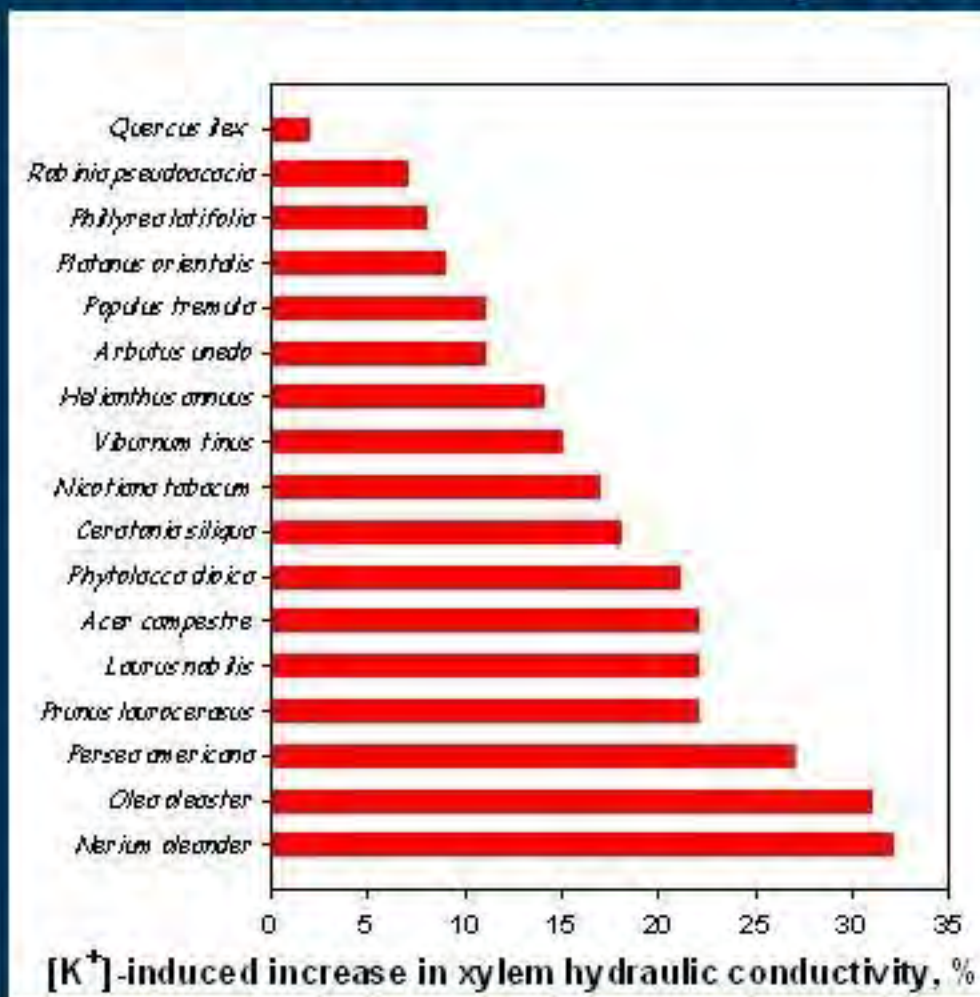

(Published and unpublished data by the authors)

Jansen et al. (2011)

XLV Congress SFV – Scuola Superiore Sant'Anna, Pisa – Luglio 2008



UNIVERSITÀ  
DI TRIESTE

# 'Hydrogel' hypothesis

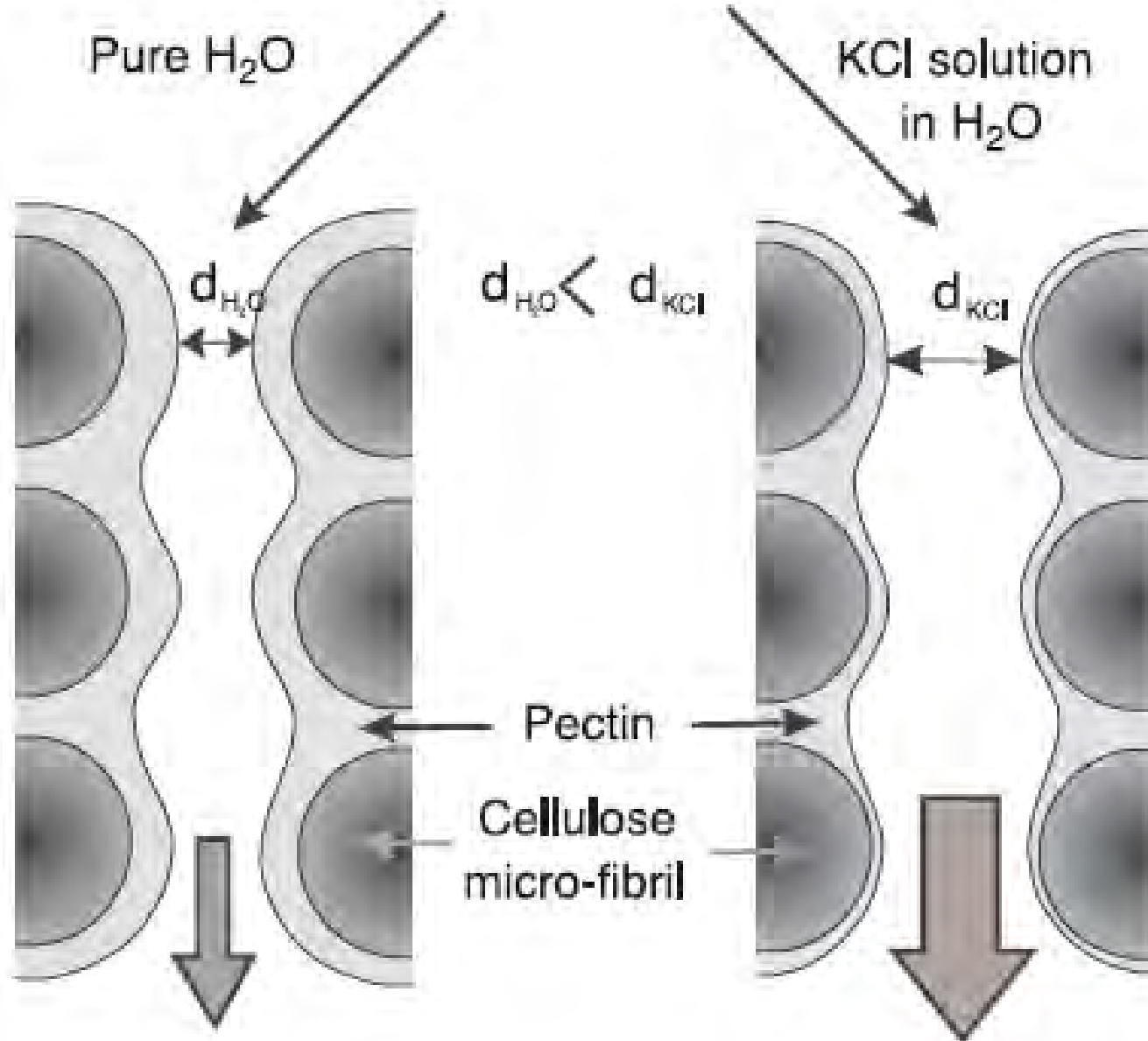

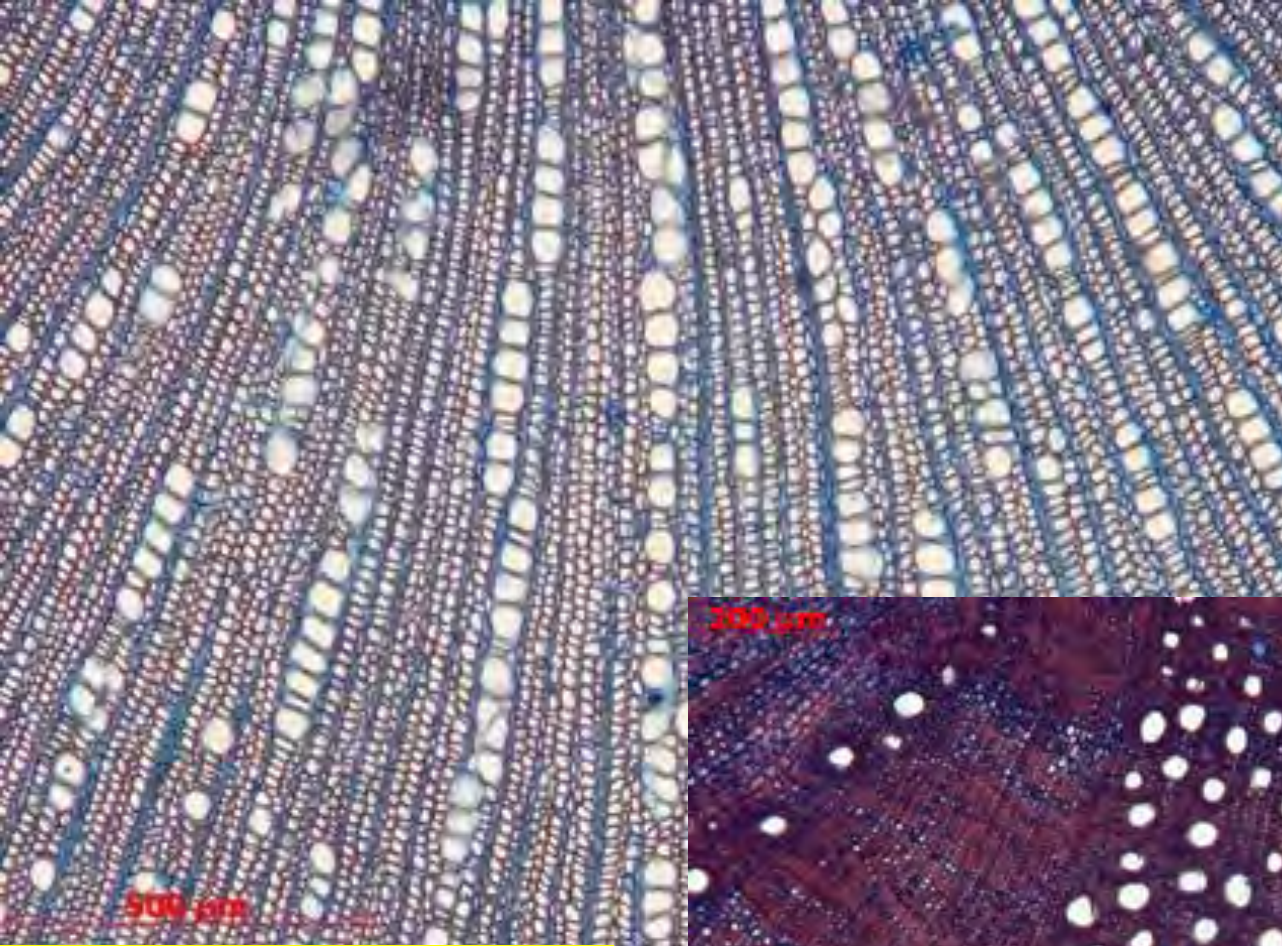

***Quercus ilex*: 1.9%  
ionic effect**

***Nerium oleander*:  
32.3% ionic effect**



# Do quantitative vessel and pit characters account for interspecific variation of the ionic-effect?

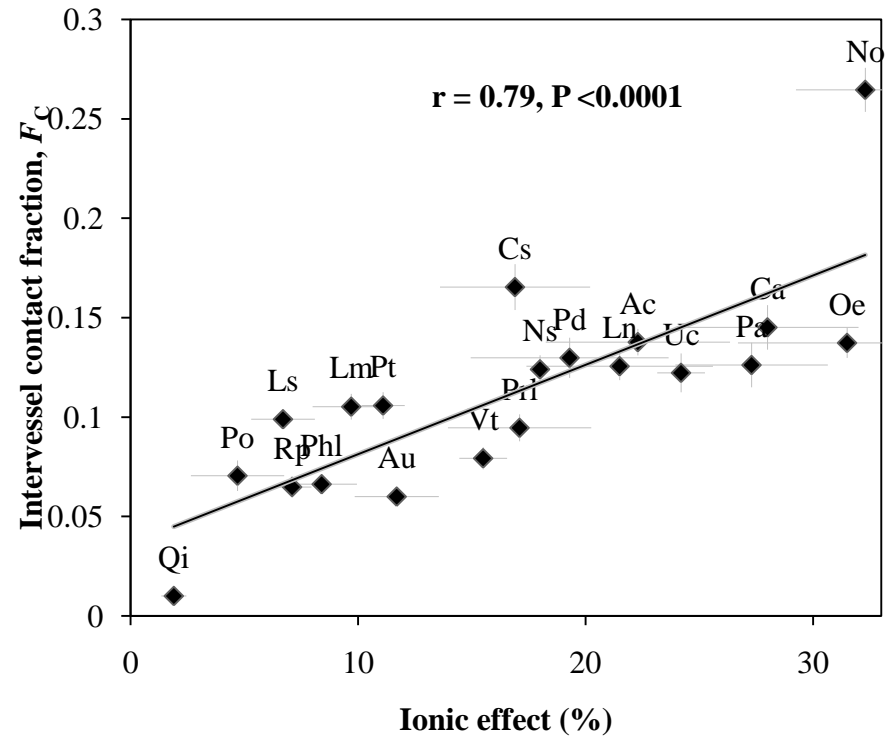
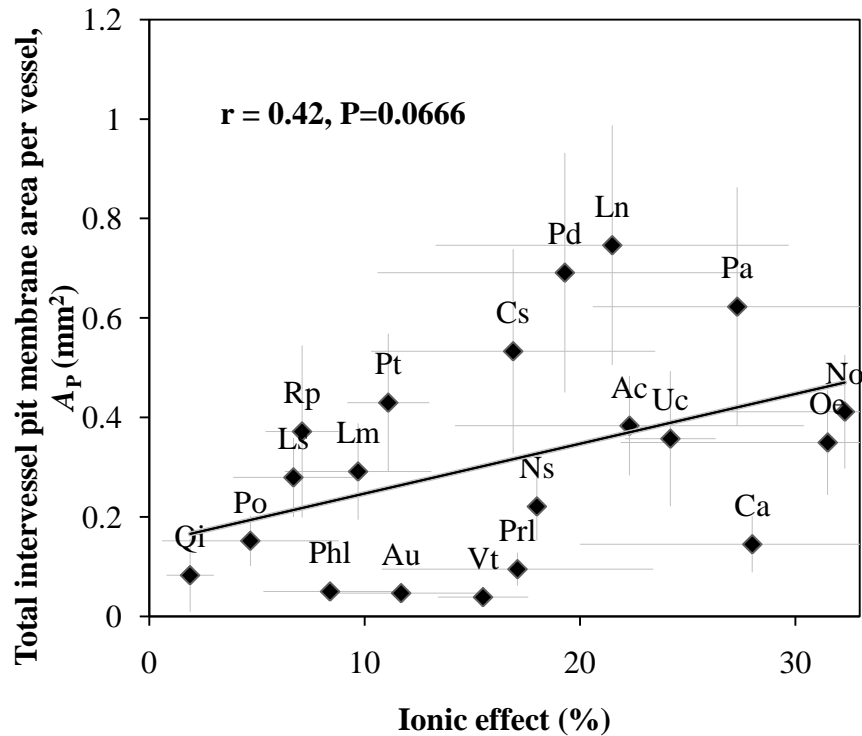

# TEM-staining with ruthenium red for acidic pectins

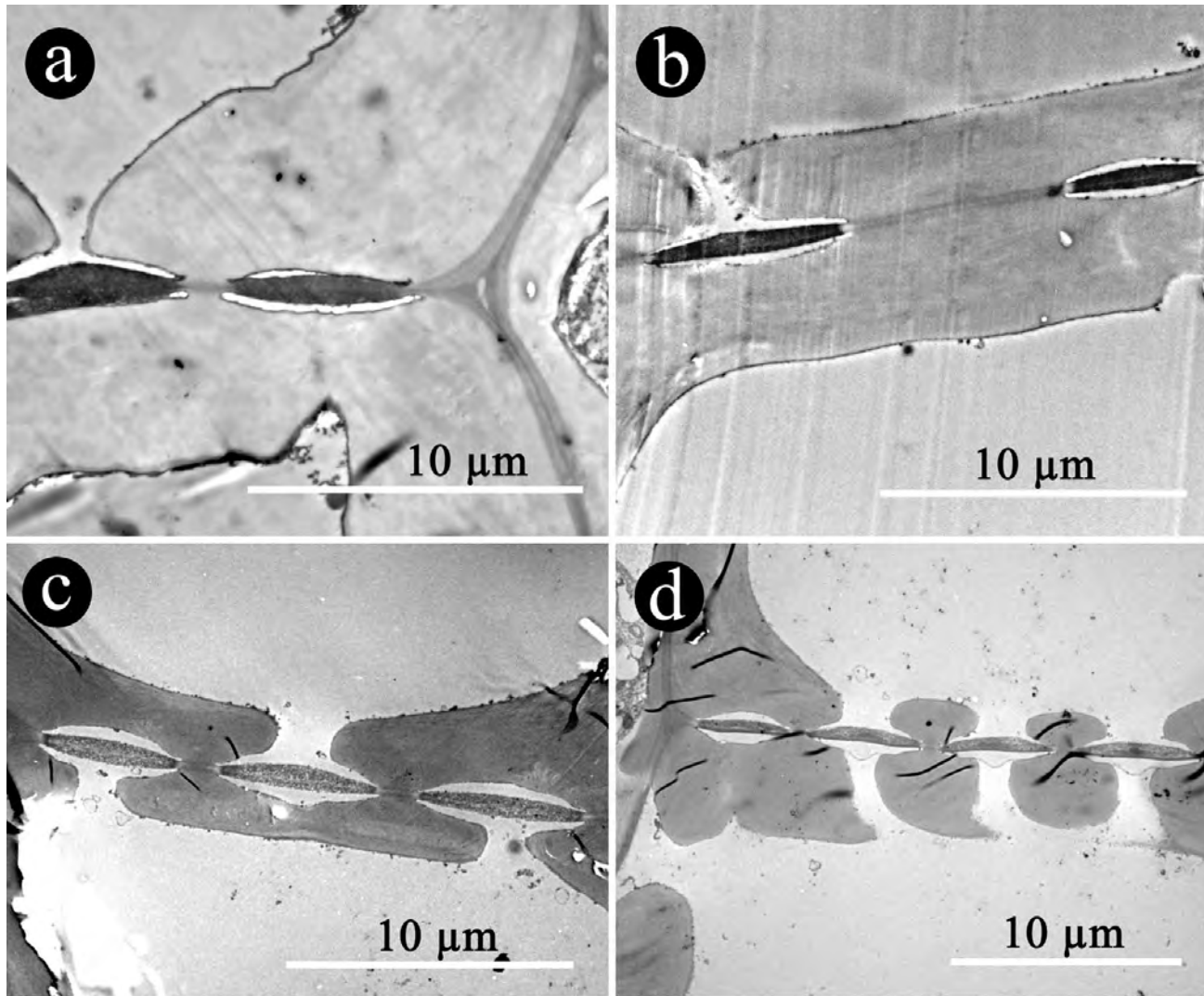

**Lauraceae (ionic effect)** a. *Umbellularia californica* (24.2%); b. *Laurus nobilis* (21.5%); c. *Litsea serica* (6.7%); d. *Lindera megaphylla* (9.7%)

Gortan et al. (2011)



# Imperforate tracheary elements

Sano et al. (2011)

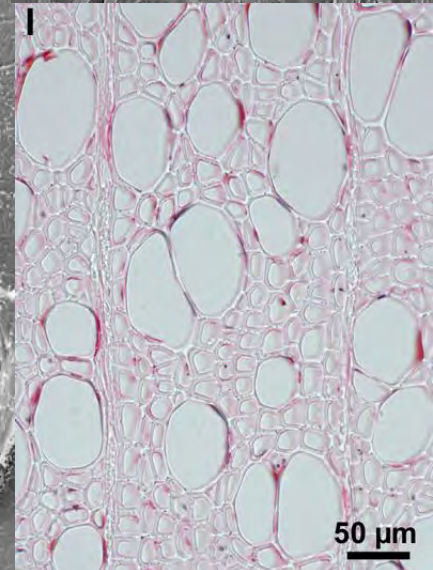
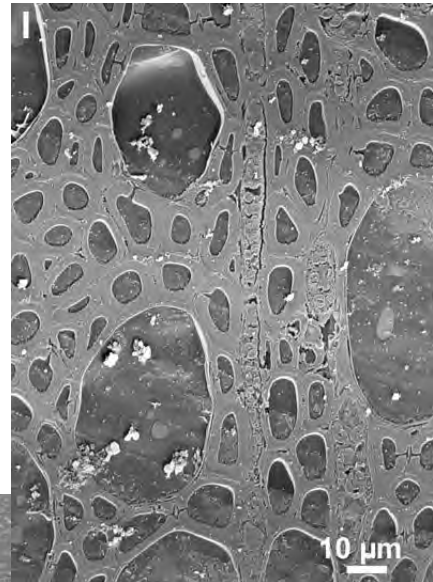
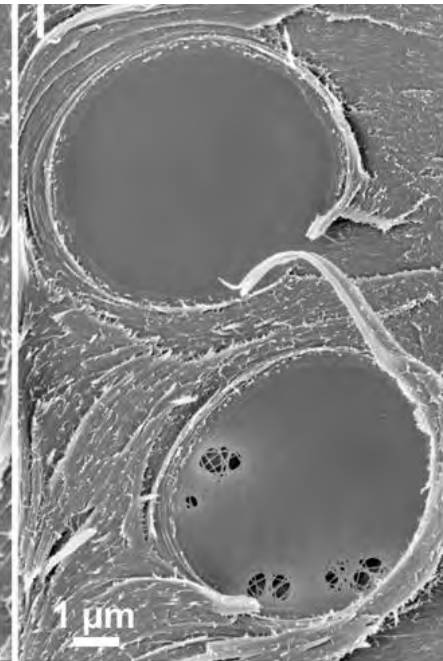
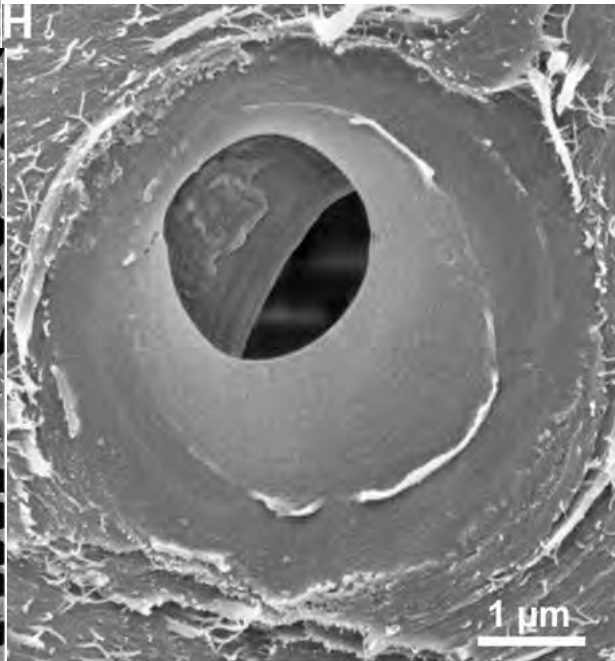
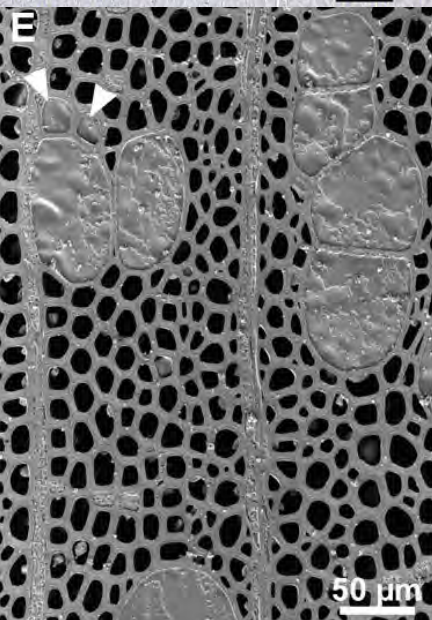

# Atomic force microscopy

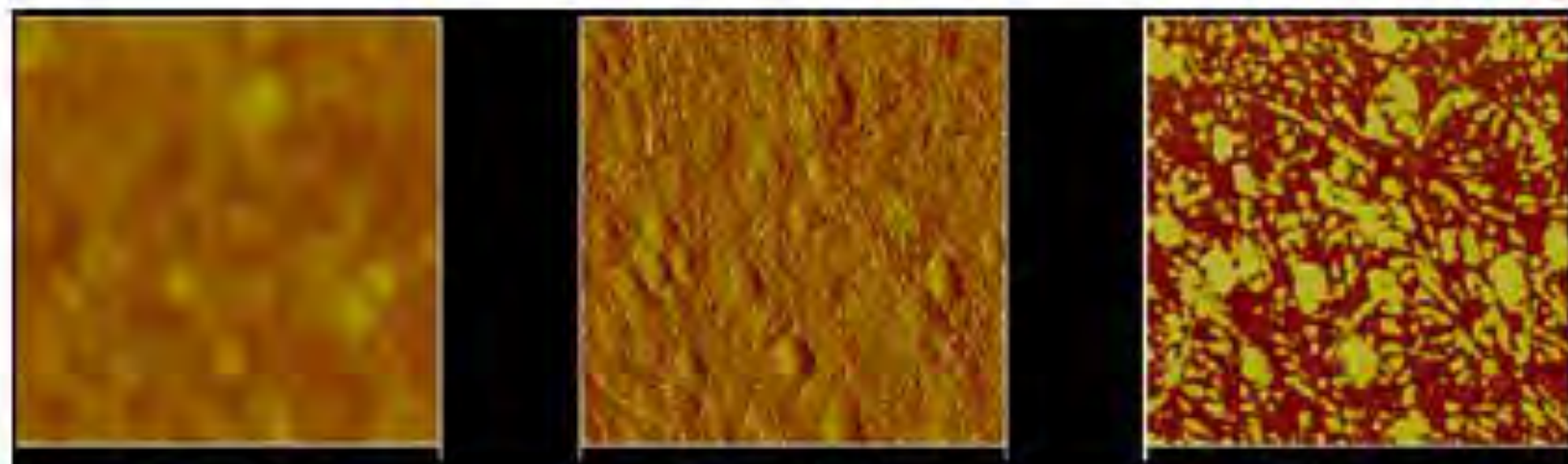
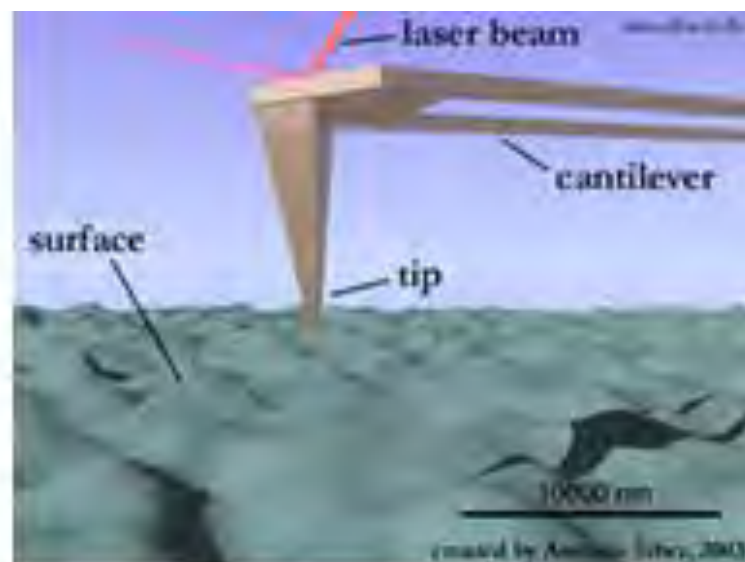

*Laurus nobilis*: air-dried pit membrane after alcohol + acetone treatment

# Resistance to embolism

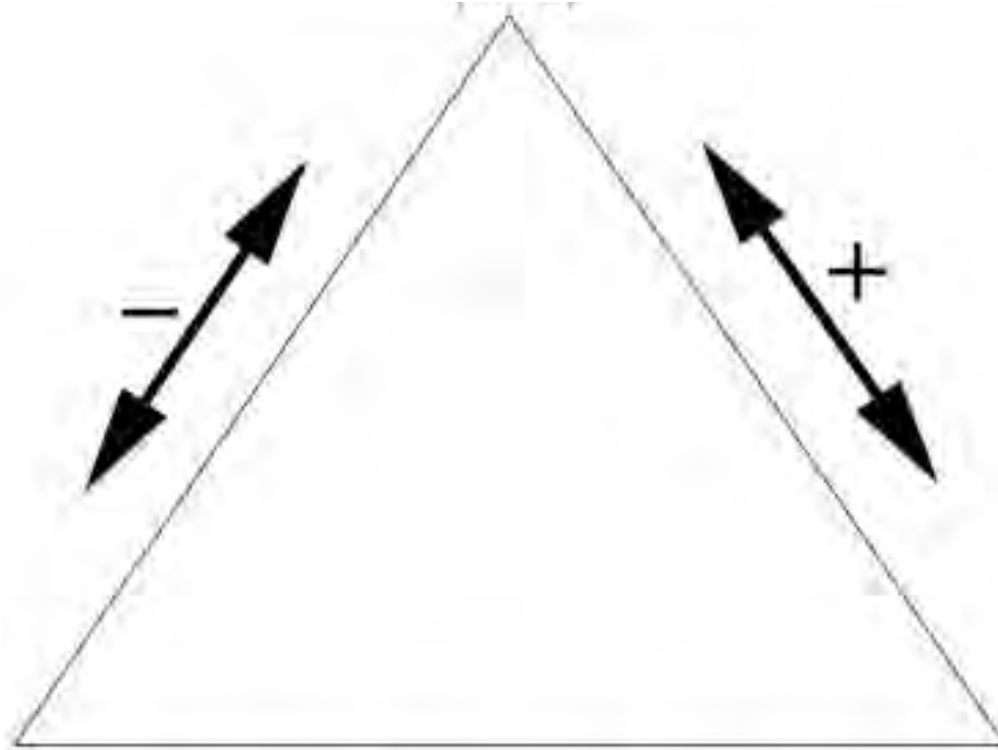

**Transport  
efficiency**

**Mechanical  
support**

Baas et al. (2004); Chave et al. (2009)

# Acknowledgements

Erika Amano, Guillermo Angeles, Pieter Baas, Brendan Choat, Hervé Cochard, Simon Connell, Sylvain Delzon, Roland Dute, Peter Gasson, Emmanuelle Gortan, Uwe Hacke, Missy Holbrook, Matthias Klepsch, Jean-Baptiste Lamy, Frederic Lens, Jordi Martinez-Vilalta, Stefan Mayr, Hugh Morris, Andrea Nardini, Alexei Oskolski, Thomas Pesacreta, Jarmilla Pittermann, Annelies Pletsers, David Rabaey, Yuzou Sano, Nele Schmitz, Alexander Scholz, Erik Smets, Anke Stein, Maciej Zwieniecki

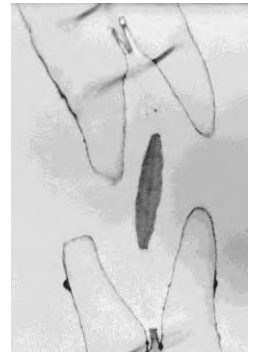
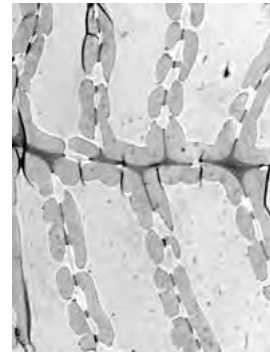
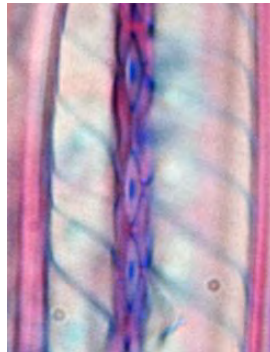
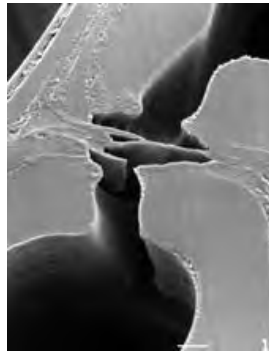
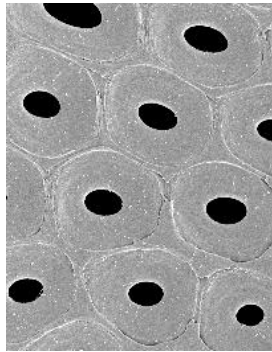
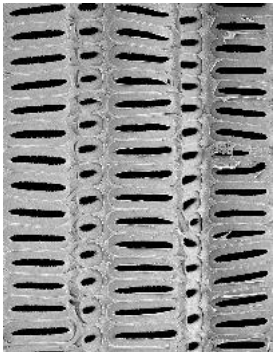

# Ultrasonic acoustic emission signals from walnut stem during freeze-thaw cycles

Jun KASUGA, Thierry AMÉGLIO

# Winter embolism

- In winter, succession freeze-thaw events induce embolism formation in water conduits in xylem of plants

## *Betula platyphylla* var. *japonica*



Growing season (April)

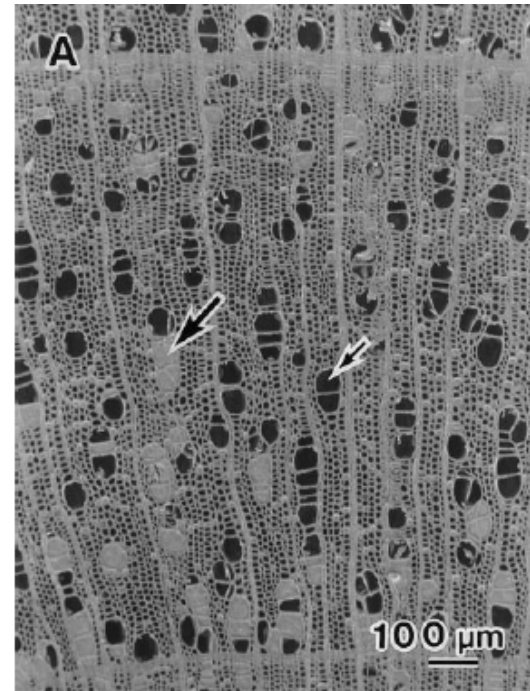

Just after winter (March)

Utsumi et al., 1998

# Mechanism of winter embolism generation

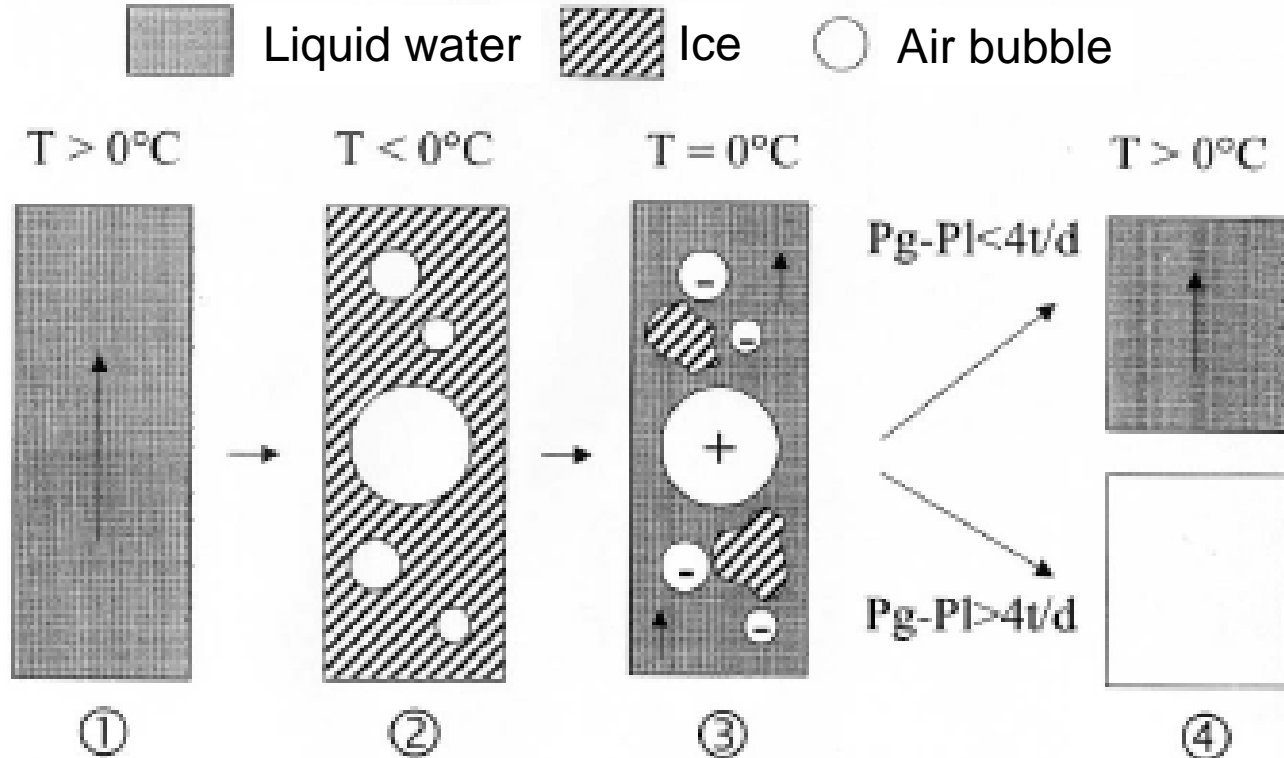

Cruziat et al., 2002

- (1)-(2) During freezing, air bubbles are created in sap
- (3)-(4) During thawing, there are two possibilities  
(depend on bubble size and water potential of sap):
- air bubbles dissolve in sap => no embolism
  - air bubbles expand => embolism

# Results contradicting the previous theory

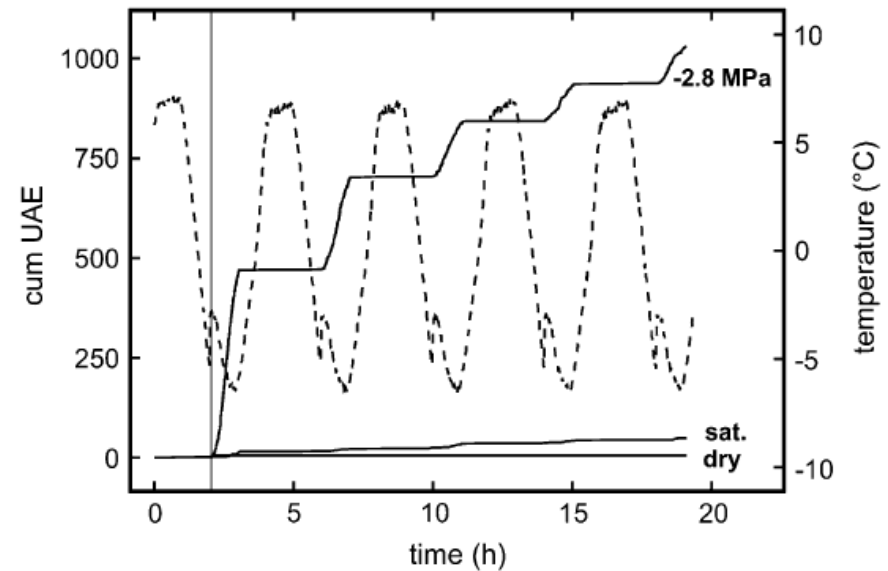
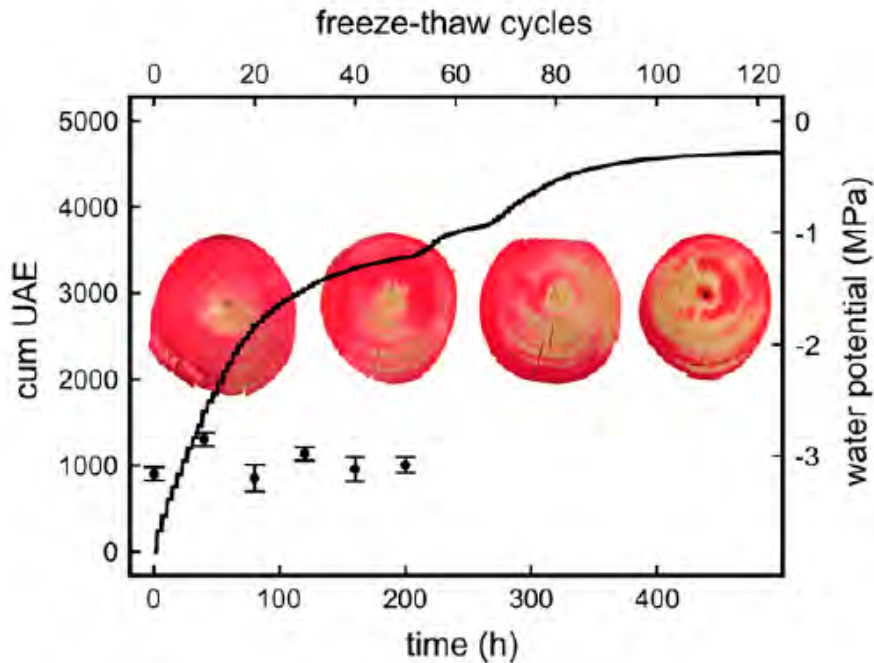

**Mayr et al. 2007**

- According to classical theory, wider tracheids in early wood are considered to be more vulnerable. However, in *Picea abies*, clustered areas of tracheids including early wood and late wood were embolized by repeated freeze-thaw cycles.
- It is thought that when cavitation happens in conduits, a rapid relaxation of a liquid tension occurs and produces an ultrasonic acoustic emission (UAE) signal. In the case of conifers, UAE were registered only in freezing process during freeze-thaw cycles.



# Objectives

- We applied an ultrasonic acoustic emission (UAE) method to walnut to elucidate the relationship between embolism formation in vessels and UAE signals during freeze-thaw cycles in angiosperm species
- Our goal is on the elucidation of mechanism of winter embolism in angiosperms

# Materials

- 2-6 year-old twigs were harvested from walnut trees (*Juglans regia* cv. Franquette) growing at INRA, Site de Crouël, Clermont-Ferrand in autumn (September to Early-November)
- The water potential of each sample was conditioned at  $-1.6$  MPa (somewhat higher value than  $\Psi_{50}$  of walnut twigs)
- 50 cm-long samples were cut from the twigs after removal of side twigs
- The samples were wrapped with thin plastic film and used for freeze-thaw experiments

# Methods

- Freeze-thaw (FT) experiment
  - One freeze-thaw cycle to different minimum temperatures ( $-10$ ,  $-25$ ,  $-40^{\circ}\text{C}$ )
  - Repeated freeze-thaw cycles from  $5$  to  $-10^{\circ}\text{C}$
- Ultrasonic acoustic emission (UAE)
  - Peak detection parameters
    - Pre-amplification gain:  $40\text{ dB}$
    - Acquisition threshold:  $45\text{ dB}$
    - Time threshold:  $400\ \mu\text{s}$
- Loss of water conductivity



# **Ultrasonic acoustic emission**

# One FT cycle to different temperatures

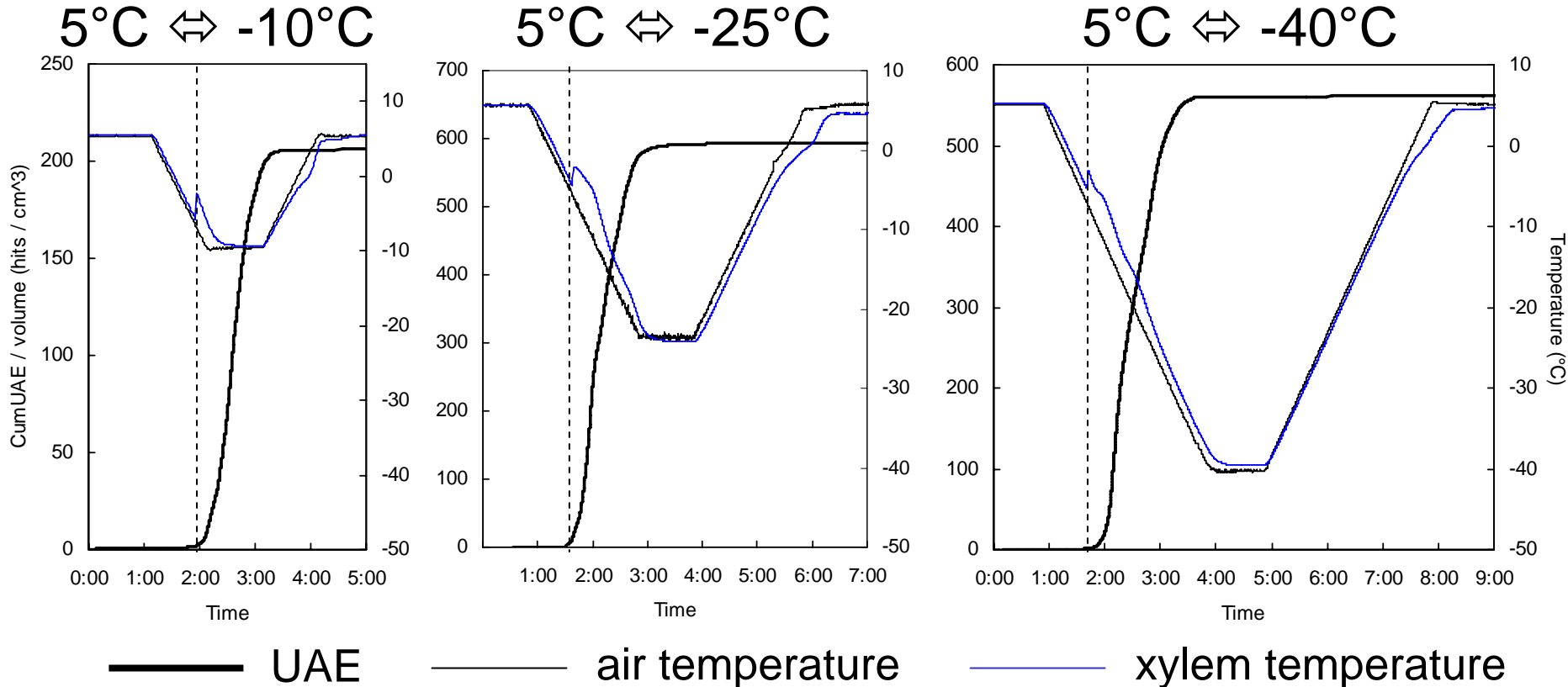

- UAE were registered only in the freezing process

# One FT cycle to $-40^{\circ}\text{C}$

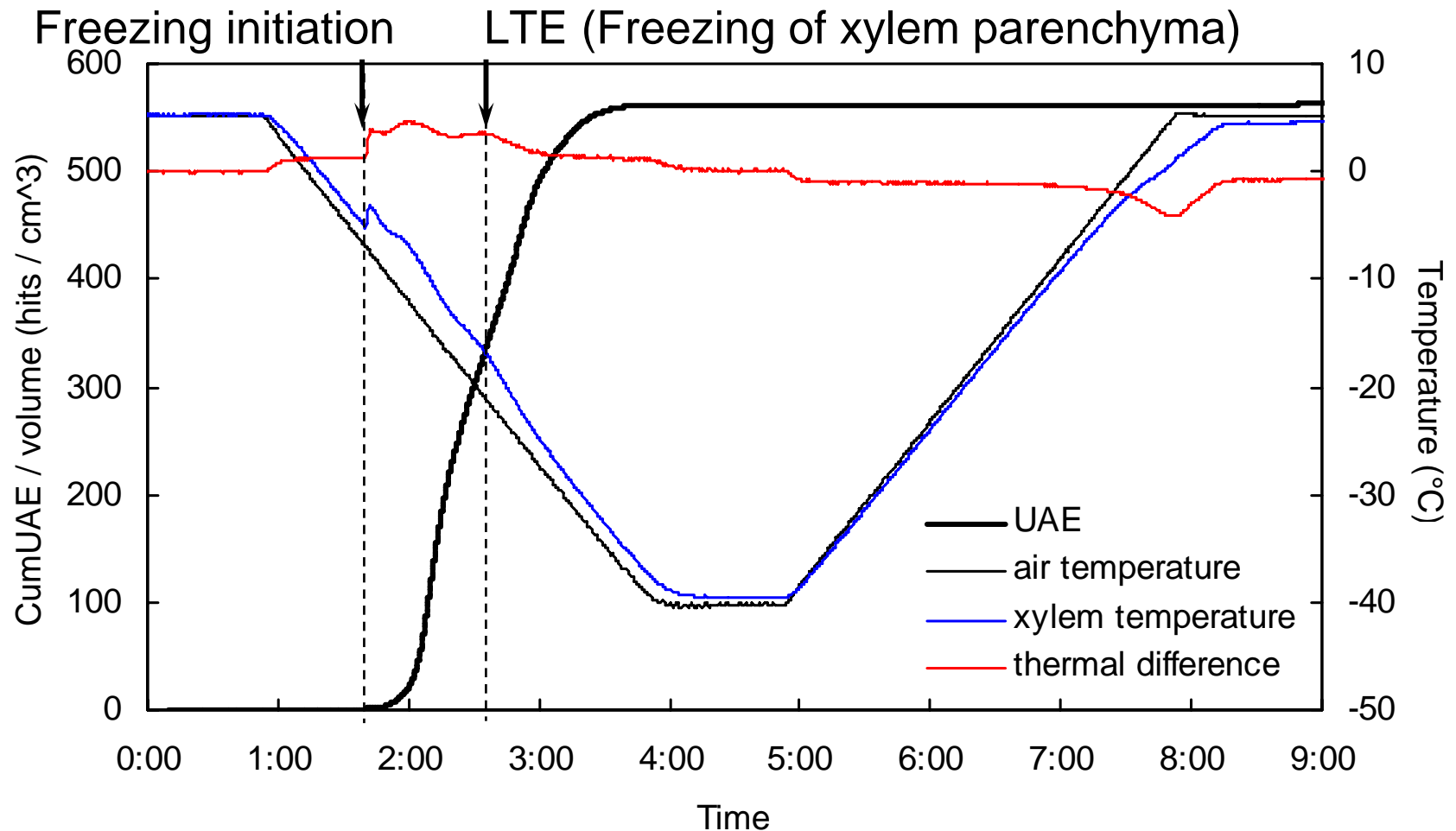

- After freezing of xylem parenchyma cells, acceleration of generation of UAE was observed

# Cumulative number of UAE during one FT cycle

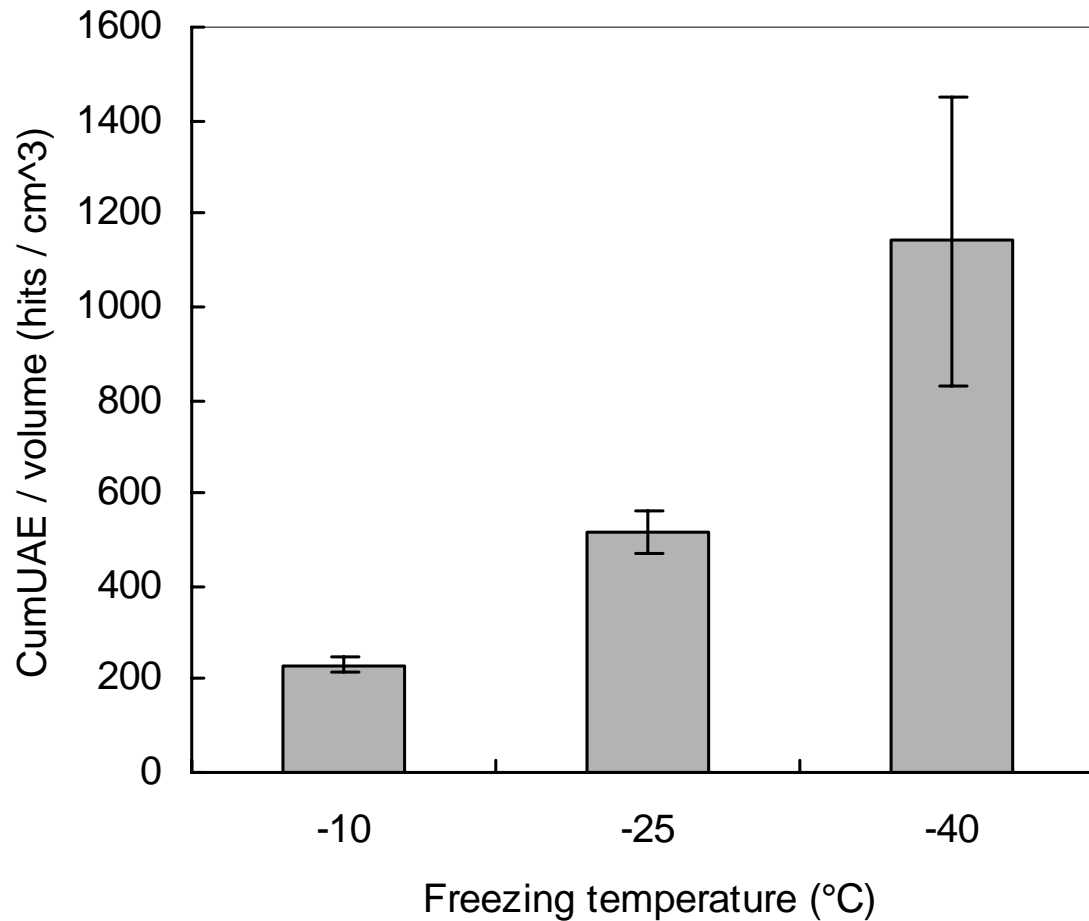

- Freezing to lower temperatures increased the cumulative number of UAE signals

# Repeated FT cycles (5°C ↔ -10°C)

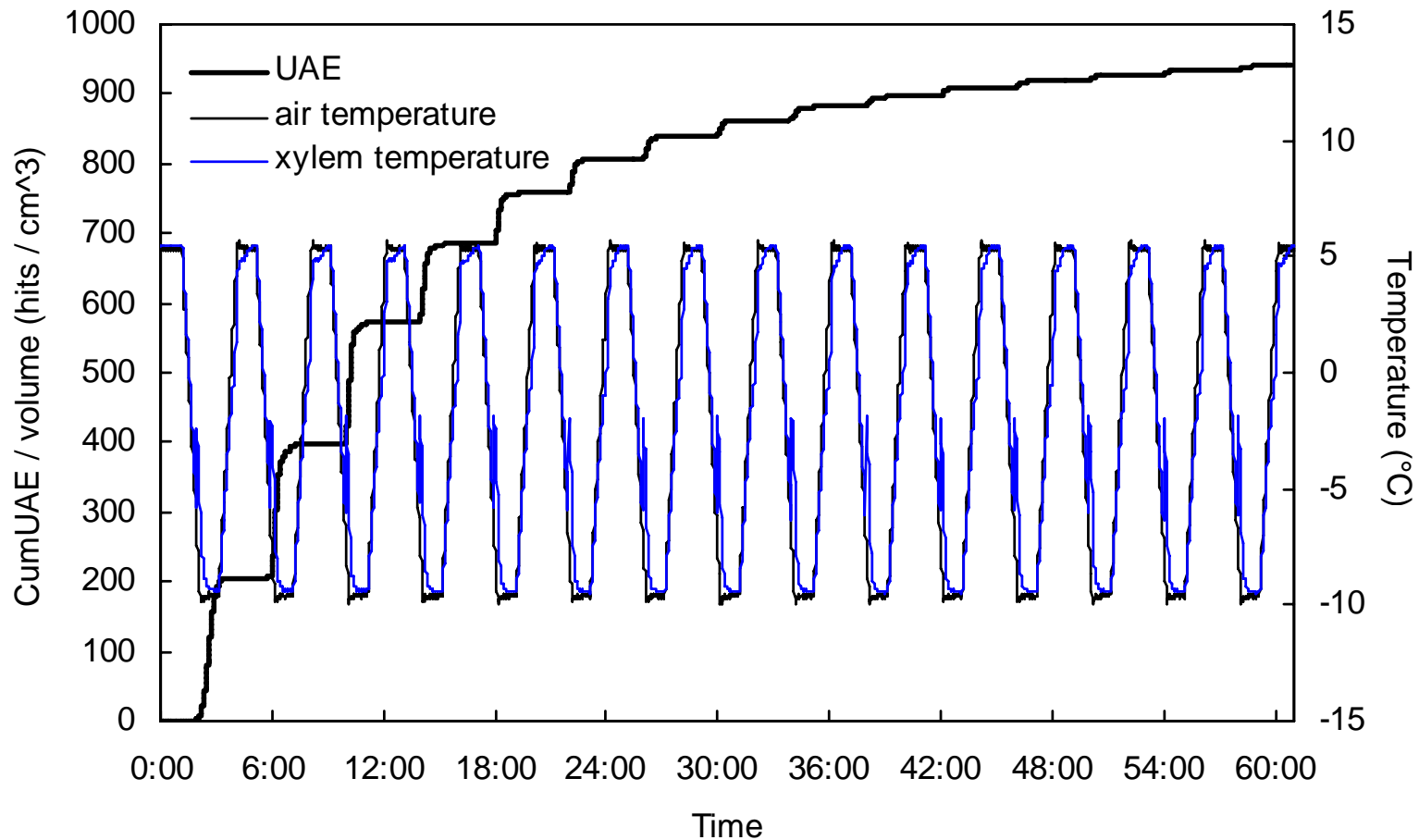

- Although there seemed to be a threshold, cumulative number of UAE kept increasing even after 15 times of FT cycles



# Cumulative number of UAE during repeated FT cycles (5°C ⇔ -10°C)

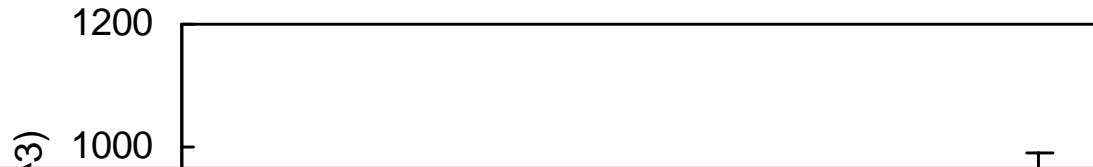

Are there any relationships between UAE generation and embolism formation?

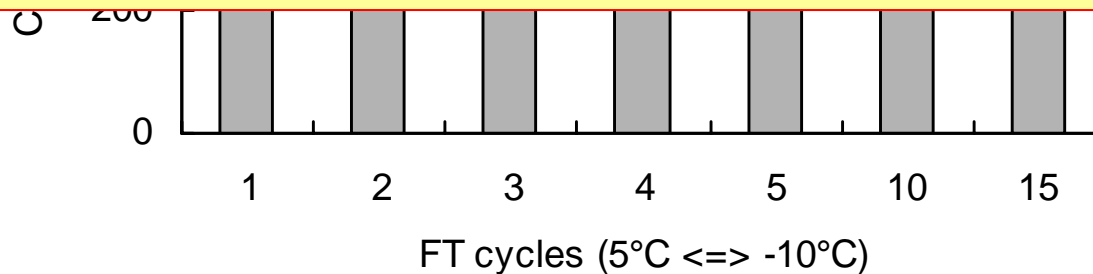

- Cumulative UAE signals were increased during repeated FT cycles

**Loss of water conductivity**

# One FT cycle to different temperatures

## Loss of conductivity

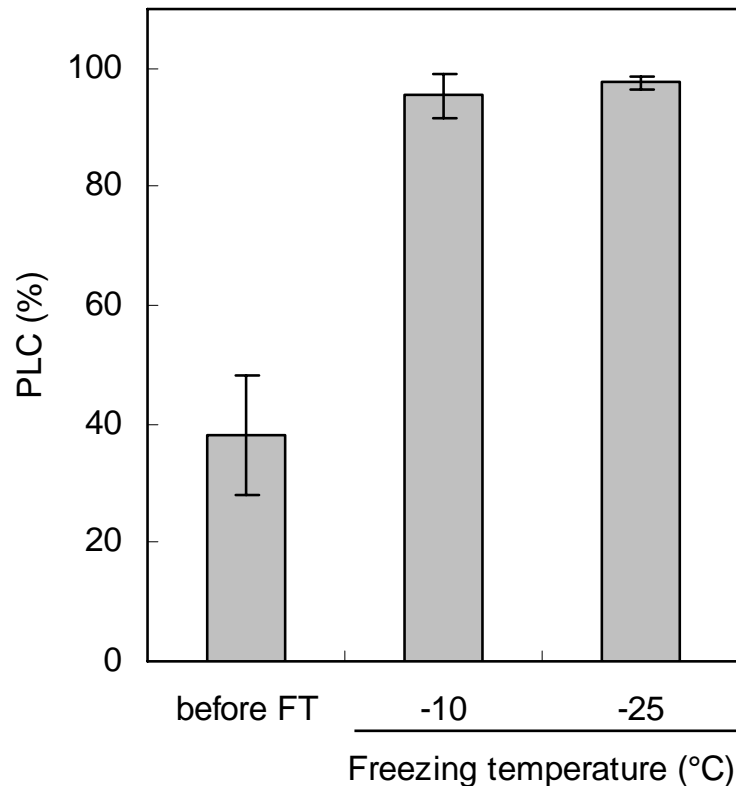

## UAE

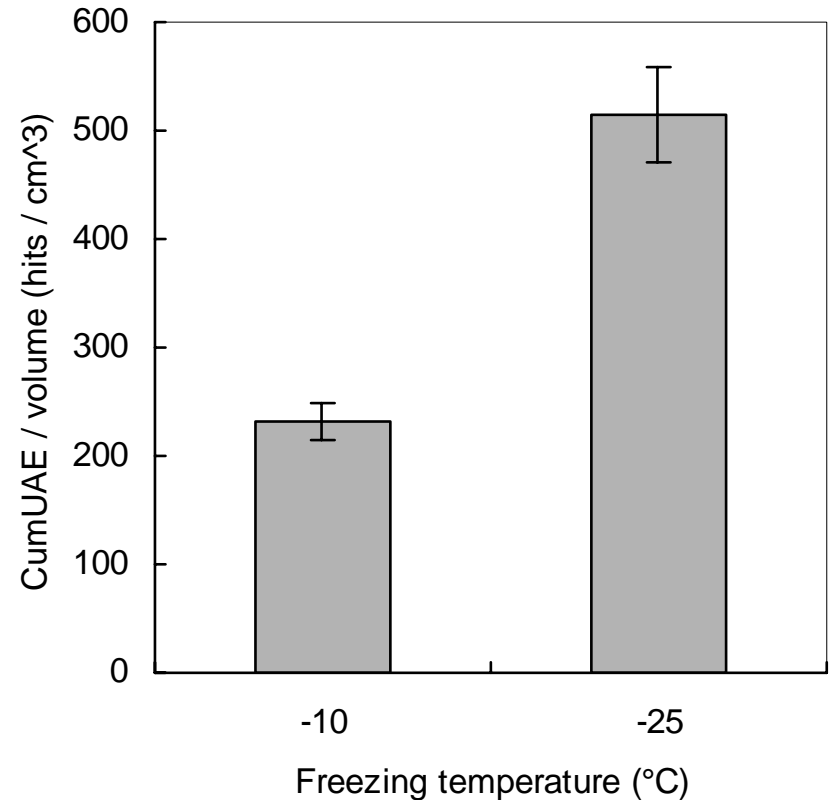

- Almost all vessels were embolized only by freezing to  $-10^{\circ}\text{C}$  although a lot of UAE signals were registered between  $-10$  and  $-25^{\circ}\text{C}$

# Repeated FT cycles (5°C ↔ -10°C)

## Loss of conductivity

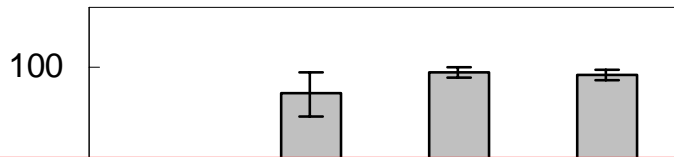

## UAE

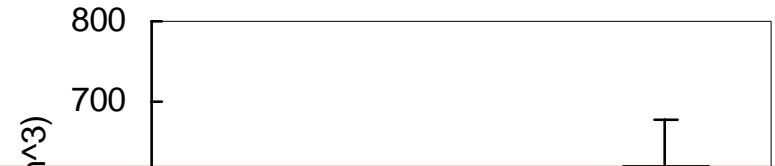

UAE signals were not only from vessel elements  
- wood fibers?  
- parenchyma cells?

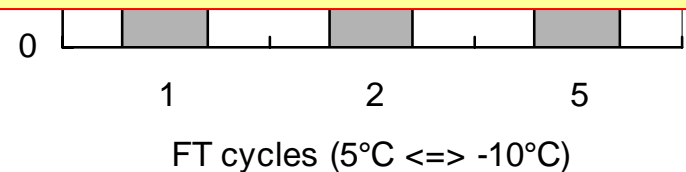
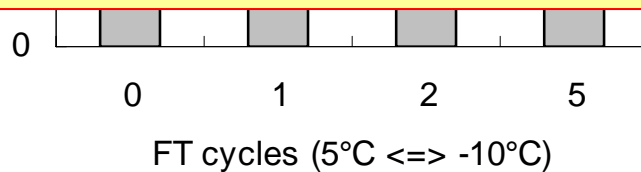

- Almost all vessels were embolized only by one FT cycle although cumulative UAE signals were increased during repeated FT cycles

# Summary of Results

- FT cycles induced UAE signals from twigs and embolism of conduits in *Juglans regia* similar to conifers
- UAE signals were registered only during the freezing process
- Freezing to lower temperatures and repetition of FT cycles increased the cumulative number of UAE signals
- After freezing of parenchyma cells, number of UAE signals increased
- Almost all vessels were embolized only by one cycle of FT between 5°C to –10°C although freezing to lower temperatures and further repetition of FT cycles increased the cumulative number of UAE signals

# Conclusion

- In this study, we could not find any correspondence between increase of cumulative number of UAE signals and those of embolized vessels
  - How and where were the UAE signals generated?
    - Fibers, parenchyma cells, etc.?
- However, because no UAE signals were registered in the thawing process, it's possible that results in this study reflect the presence of other mechanism of embolism formation than the classical theory in angiosperms
- We are attempting to observe the changes in distribution of water in twigs during freeze-thaw cycles by cryo-scanning electron microscope

# Cryo-scanning electron microscopy

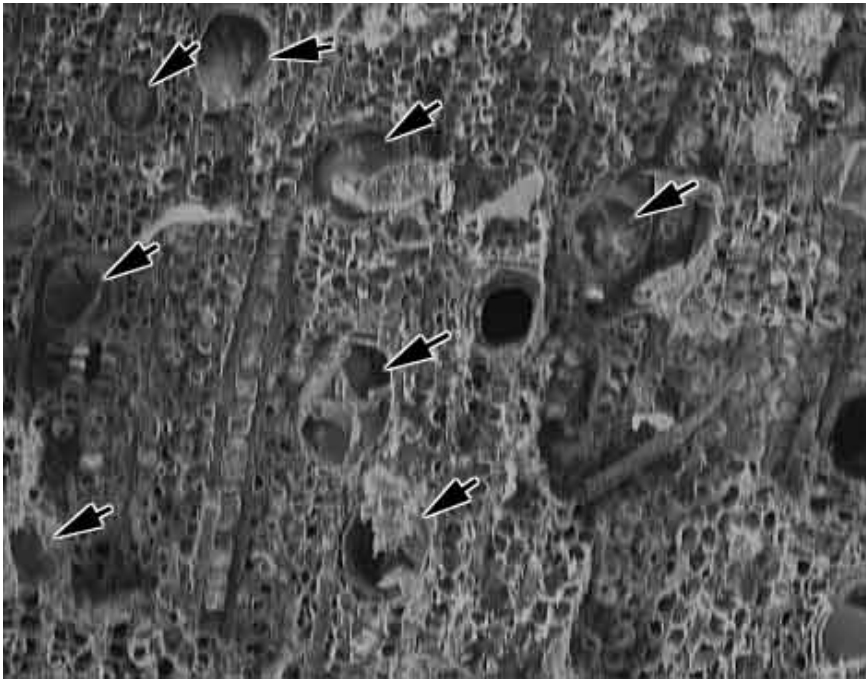

Before FT

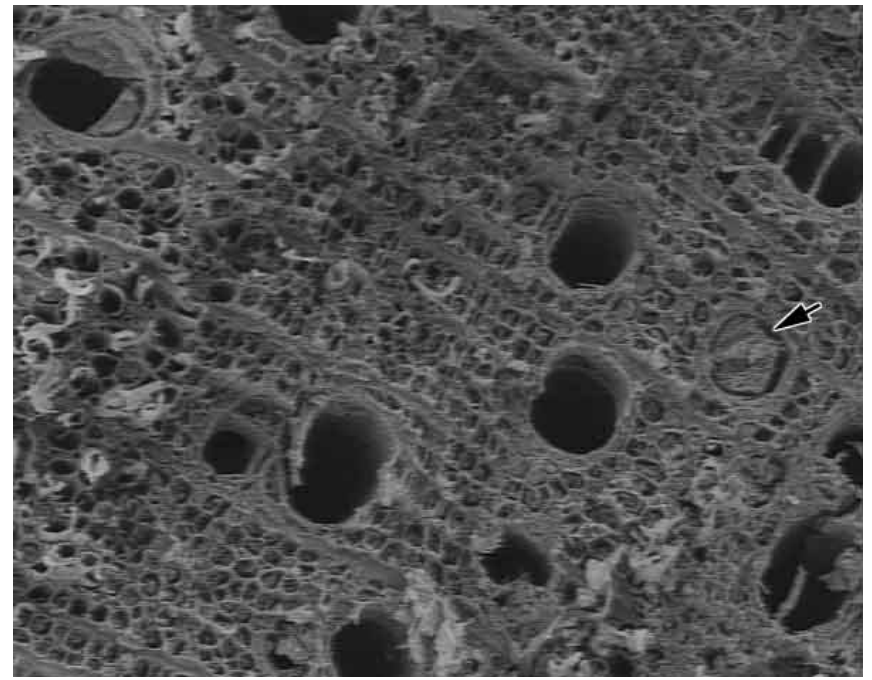

After FT (5  $\leftrightarrow$  -25°C)

- 
- **Special thanks:**
    - **Christian BODET**
    - **Guillaume CHARRIER**
  - **This work is partly supported by Japan Society for the Promotion of Science**

**Merci pour votre attention!**





**Micro-evolutionary point of view of drought  
tolerance traits in *Pinus pinaster***

**Lamy J.B., Plomion C., Cochard H., Bouffier L., Lagane, F., Burlett R.,  
Delzon S.**

# Introduction

## Extreme Climatic events



El Niño event

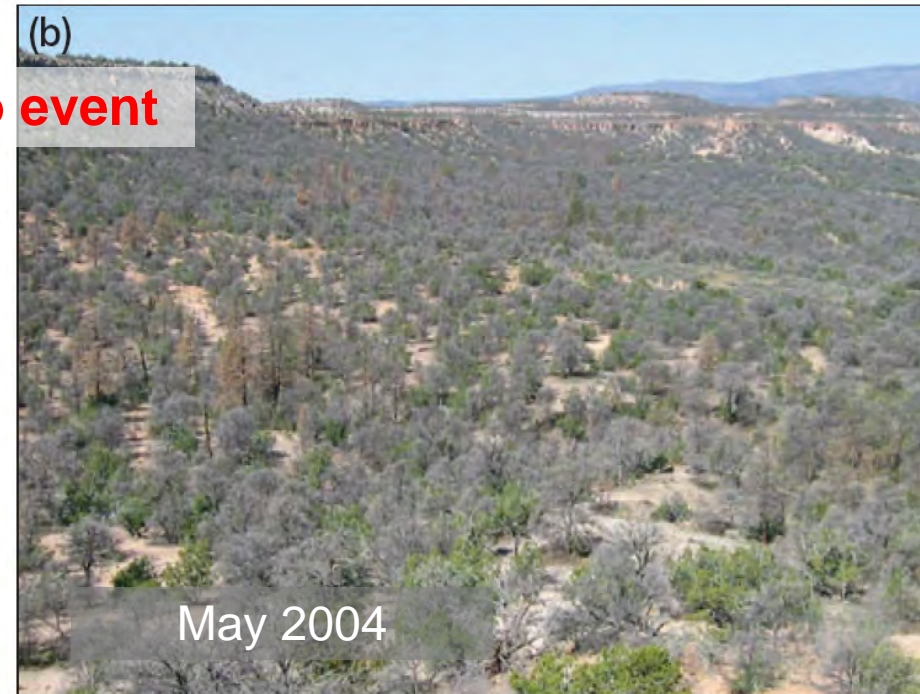

Breshears et al 2009

*Juniperus monosperma*

*Pinus edulis*

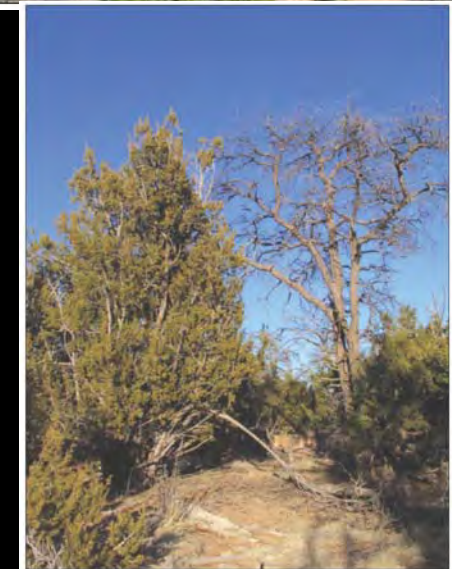

Which traits could trace the drought tolerance ?

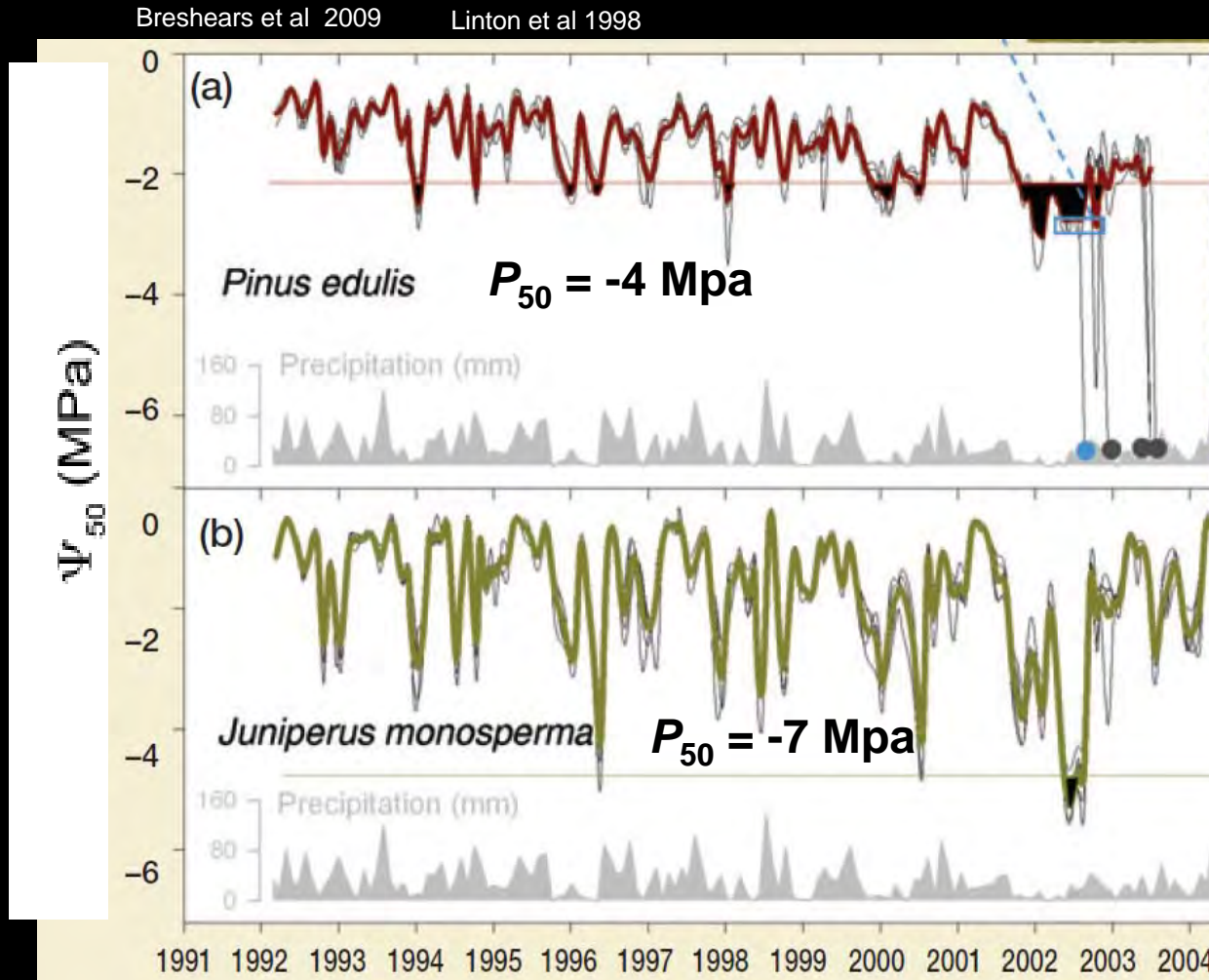

Embolism is an direct causal factor of trees ' death

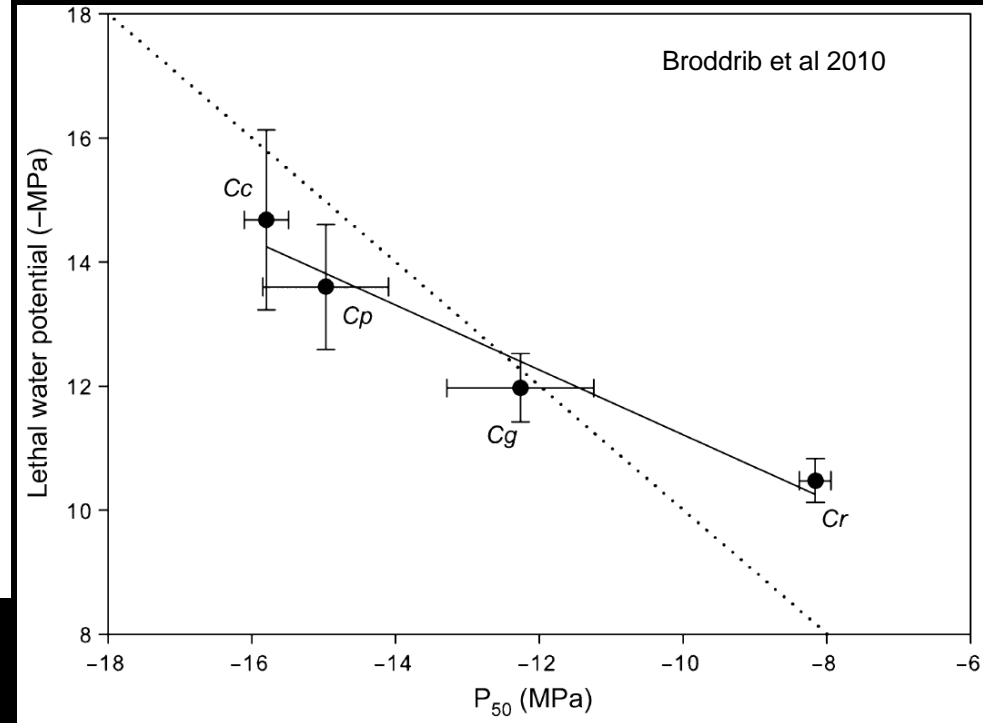
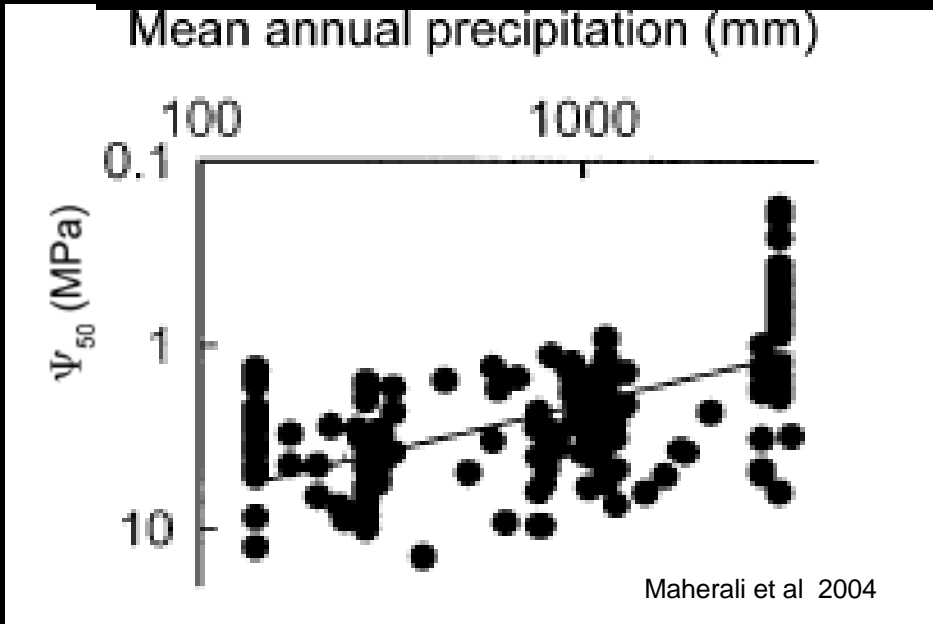

From a physiological point of view, cavitation resistance is a key drought tolerance

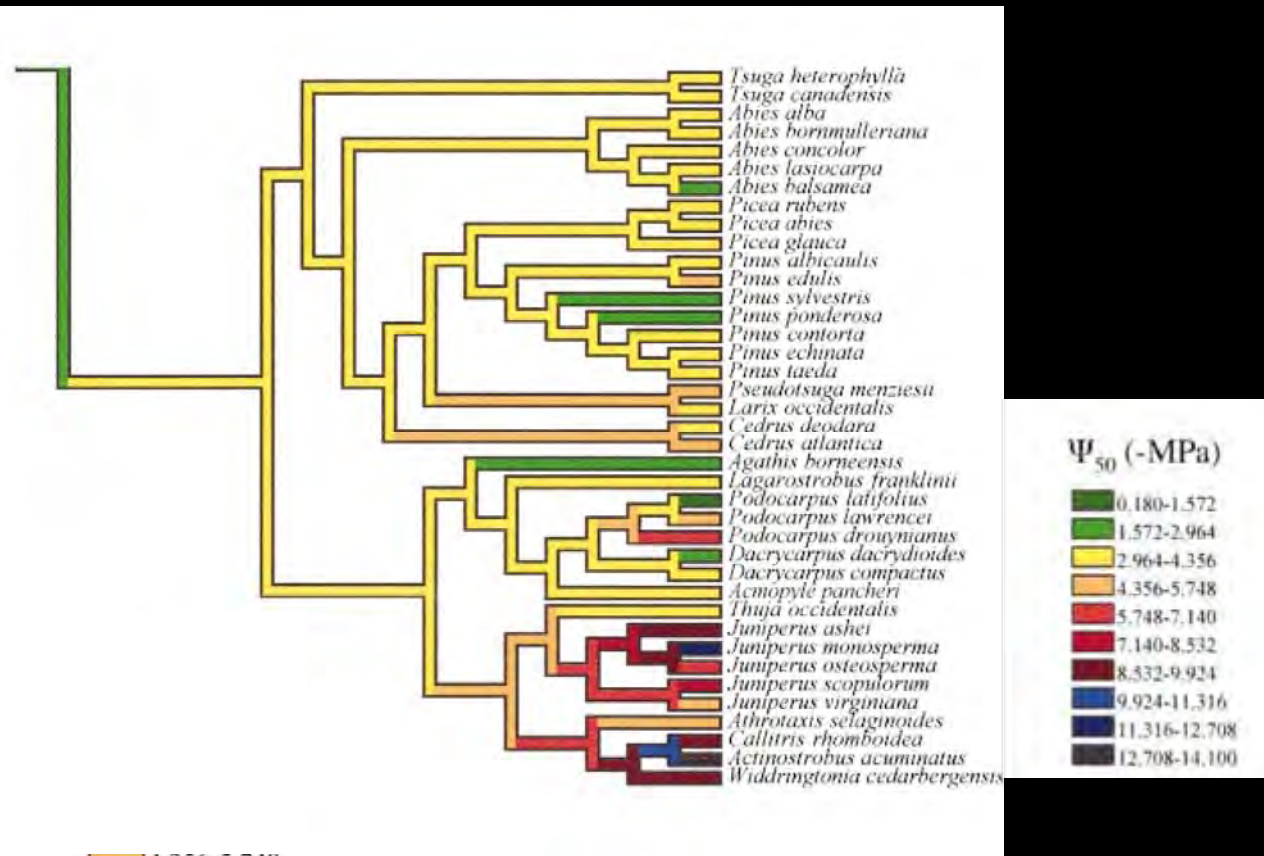

What evolutive forces have driven the evolution of these traits ?

...correlation between traits

...Check the postulate “cavitation resistance is a target of natural selection”

There is Genetic differences between populations ?

What evolutive forces drive the evolution of these traits ?

What are the correlation between traits

# Material et Methods

<b>characters</b>	<b>Unit</b>	<b>Symbol</b>
<b>Pressure inducing 50 % loss of conductance</b>	<b>MPa<sup>-1</sup></b>	<b><i>P</i><sub>50</sub></b>
<b>Wood microdensity</b>	<b>dimensionless</b>	<b><i>D</i></b>
<b>Carbon 13 isotopic composition</b>	<b>‰</b>	<b><math>\delta^{13}\text{C}</math></b>
<b>Height increment between 2004 2005</b>	<b>mm</b>	<b><math>\Delta_h</math></b>
<b>Total dry biomass 2005</b>	<b>g</b>	<b><i>B</i><sub>TOT</sub></b>
<b>Total needle area 2005</b>	<b>m<sup>2</sup></b>	<b><i>A</i><sub>LEAF</sub></b>

## Climate origin of populations

- 6 populations
  - 8 mother tree
  - 5 half-sibs
- = 240 genotype

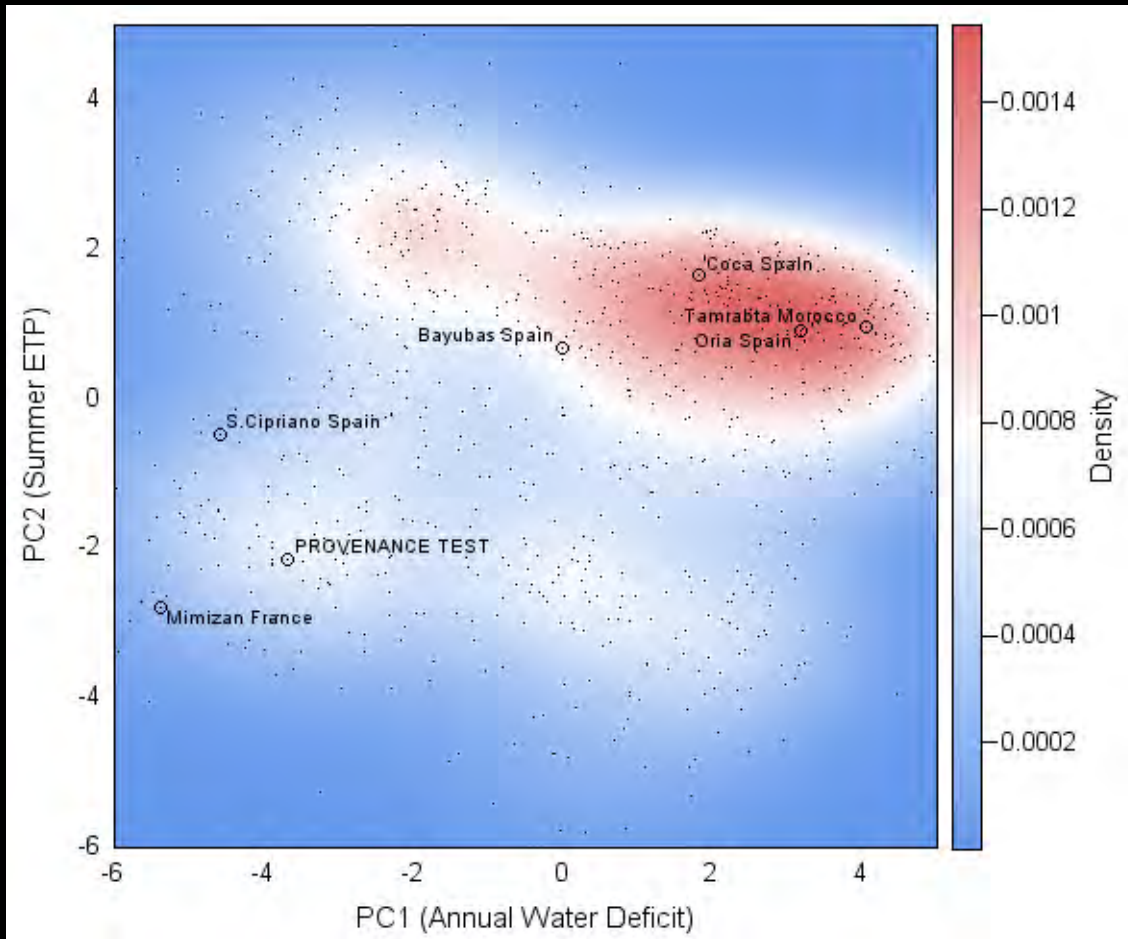

Lamy & al 2010 submitted

Spatial location of populations from Bucci et al 2007

Climatic data from New et al 2002





## Hydraulic character

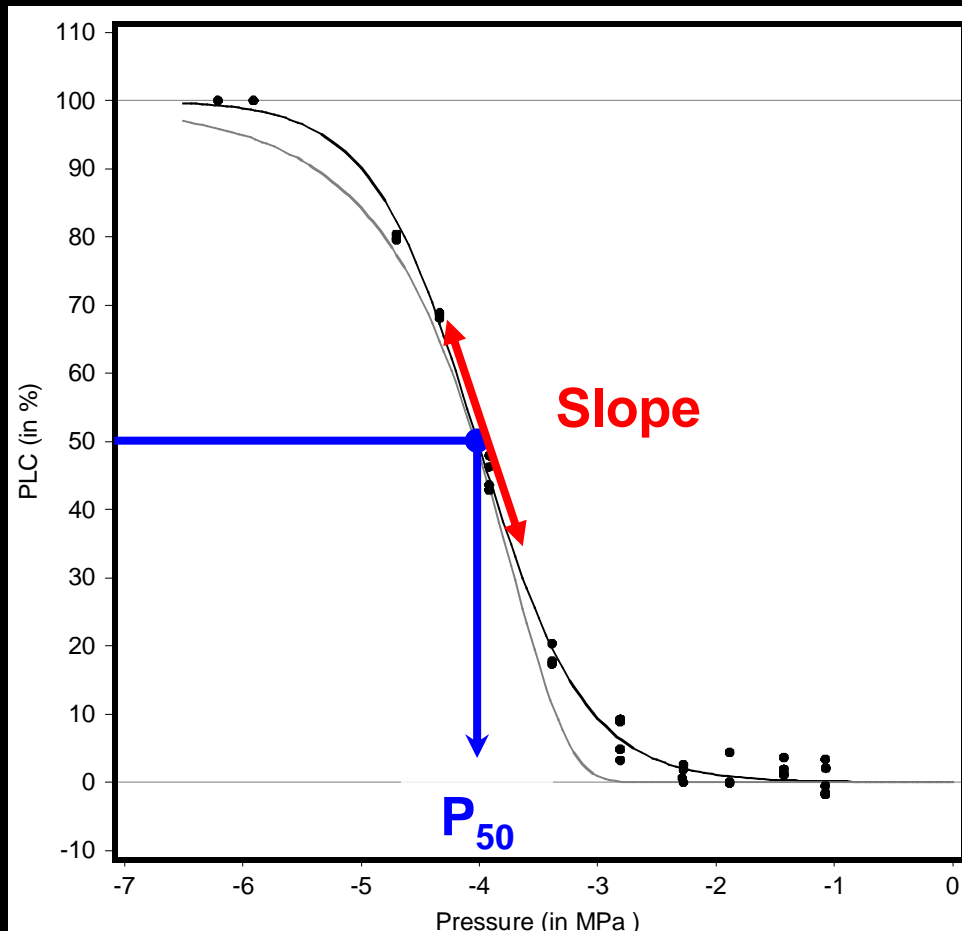

**Vulnerability curves**

### TECHNICAL FOCUS

#### Evaluation of a new centrifuge technique for rapid generation of xylem vulnerability curves

Hervé Cochard<sup>1,2\*</sup>, Gaëlle Damour<sup>3</sup>, Christian Bodet<sup>3</sup>, Ibrahim Tharwat<sup>4</sup>, Magalie Poirier<sup>4</sup> and Thierry Améglio<sup>3</sup>



« Feu Cavitron 2 »

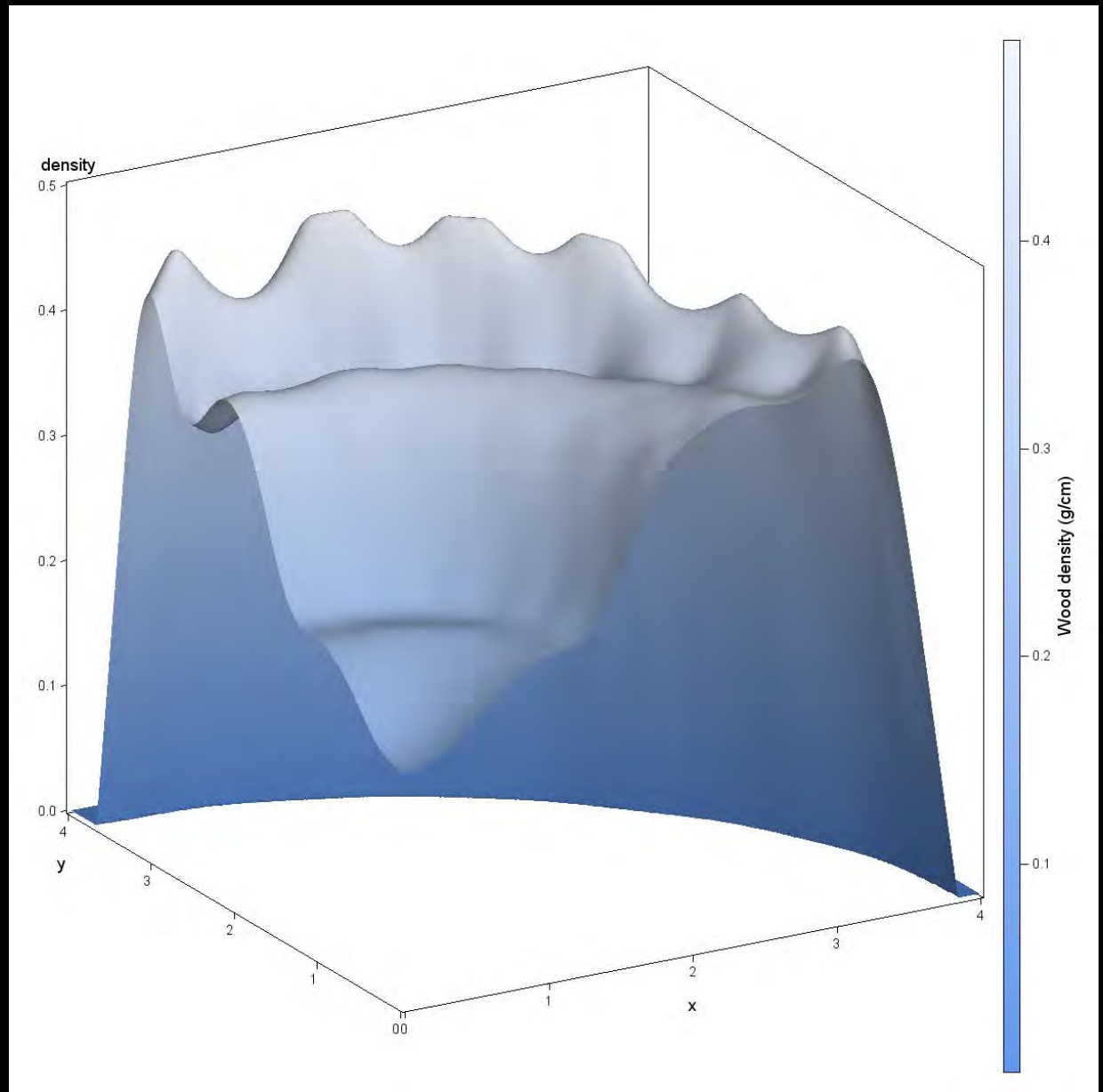
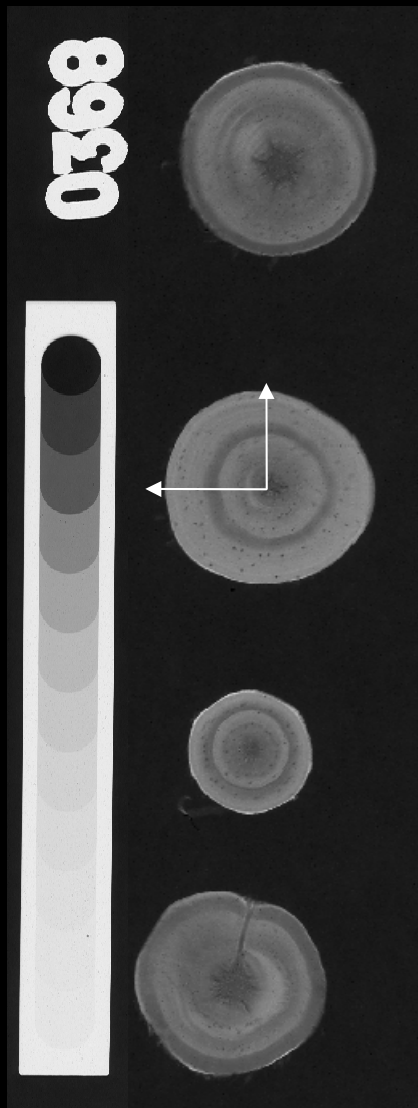

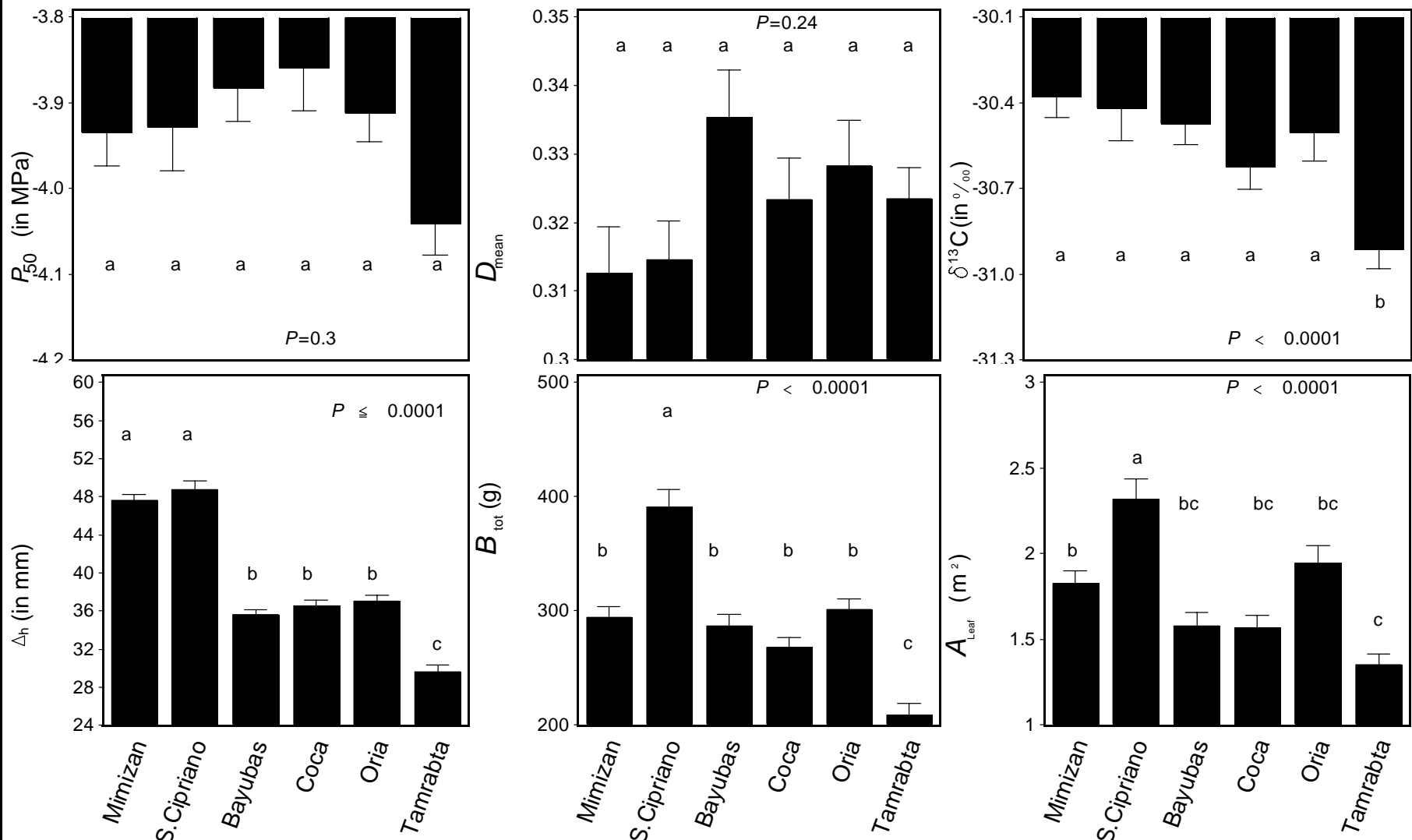

Lamy & al 2010 submitted

No phenotypic difference between population for wood-related traits

Phenotypic difference between population for the other traits.

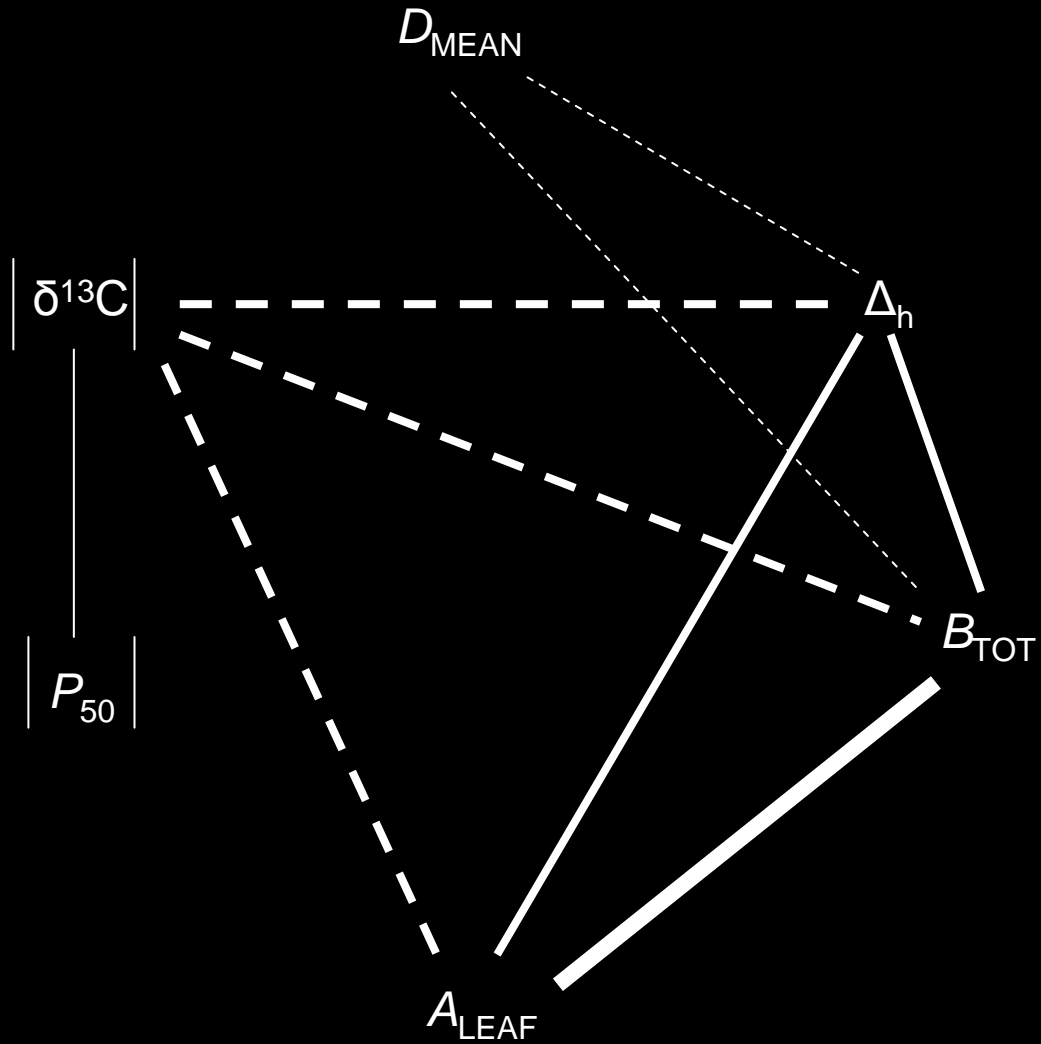

# Concepts

- Phenotypic variation :

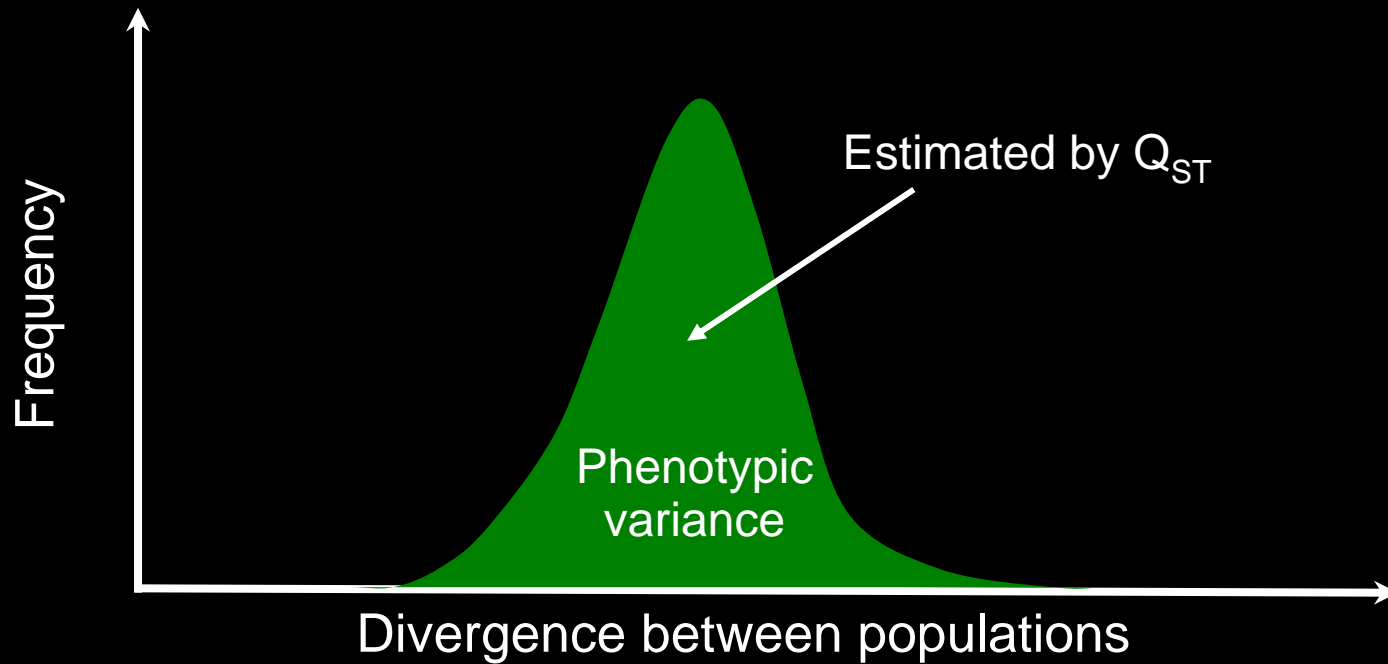

# Concepts

- Genetic drift

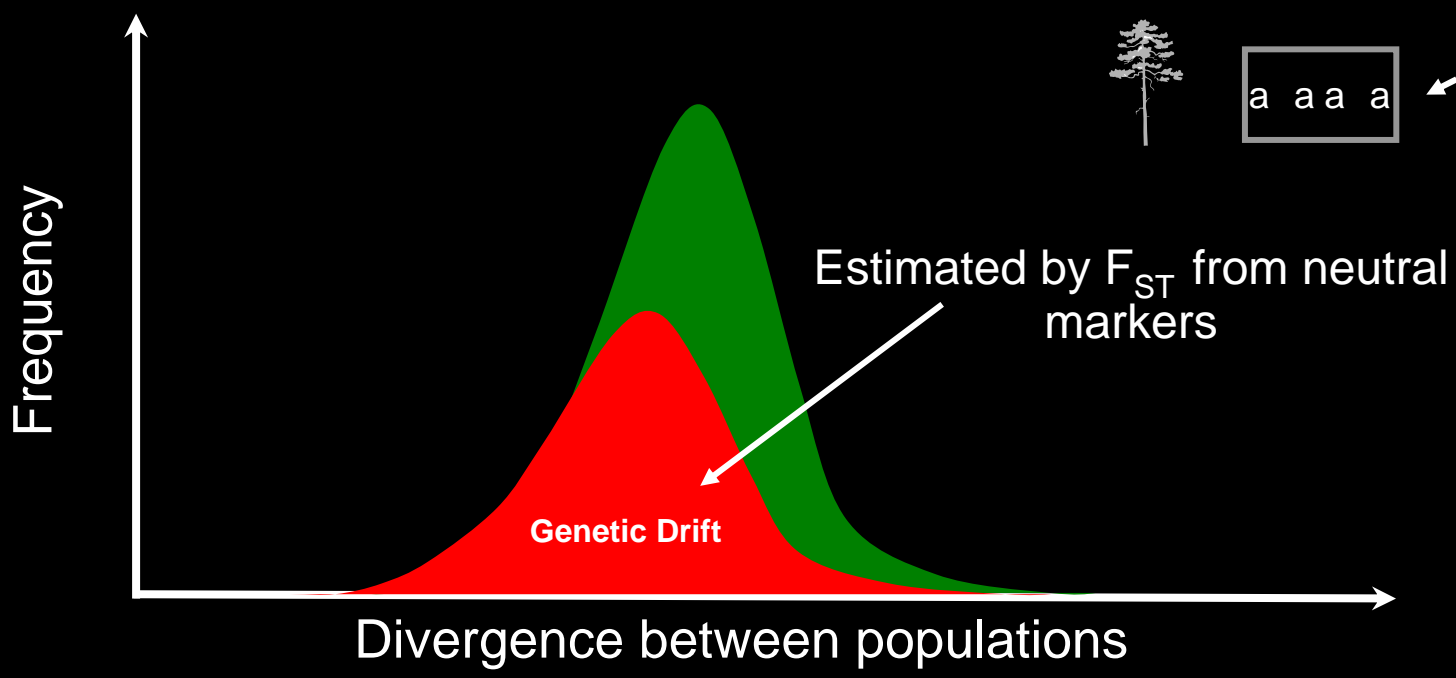
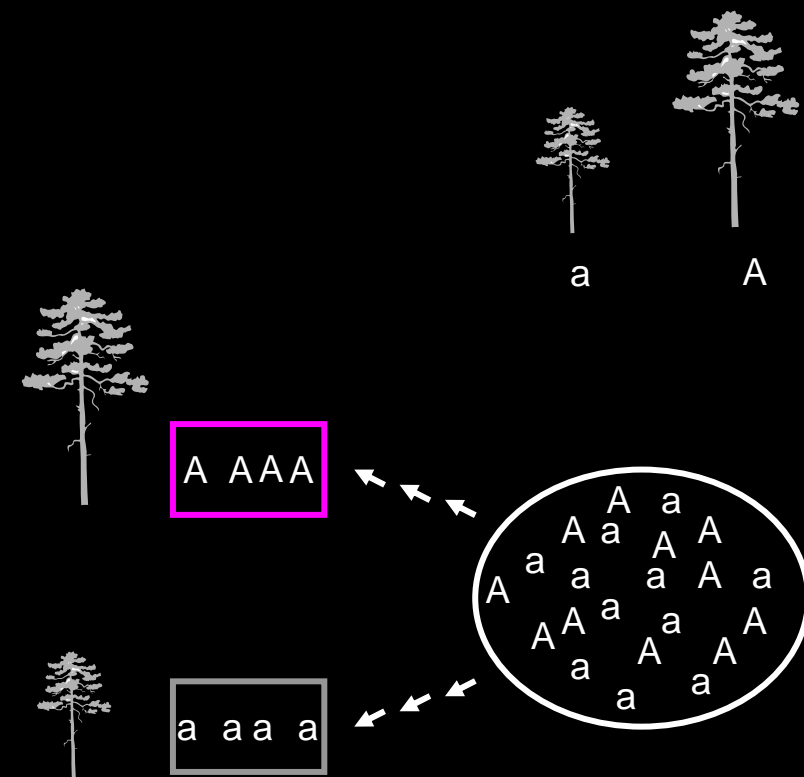

# Concepts

- Genetic drift or Selection

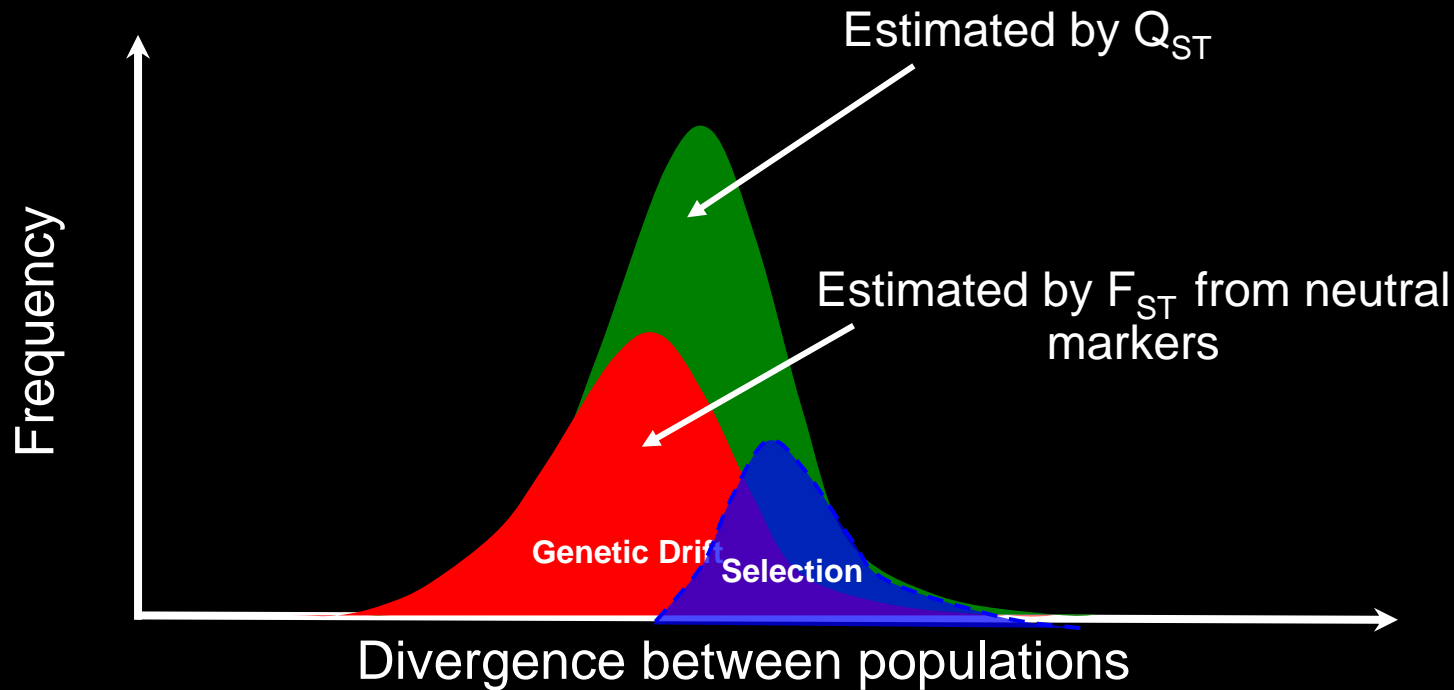

## Genetic drift or Selection ?

• In theory :

$$Q_{ST} = F_{ST}$$

$$Q_{ST} > F_{ST}$$

$$Q_{ST} < F_{ST}$$

**Drift**

**Diversifying selection**

**Uniform selection**

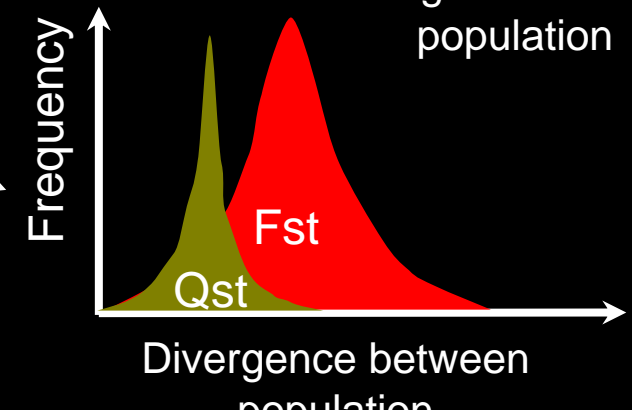
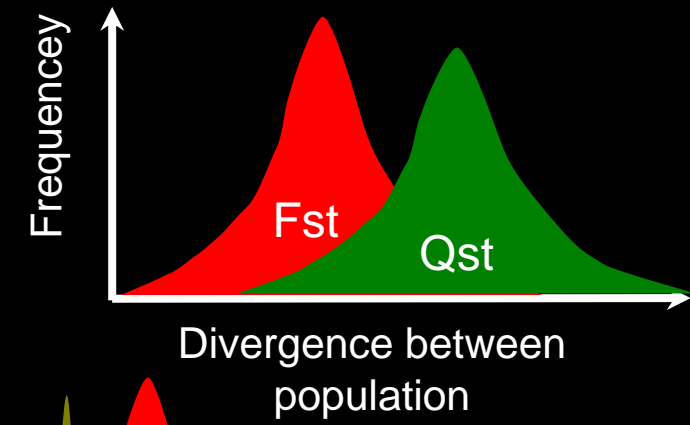
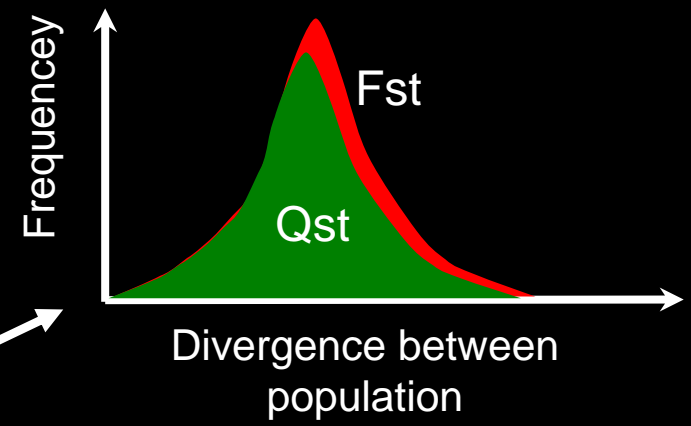



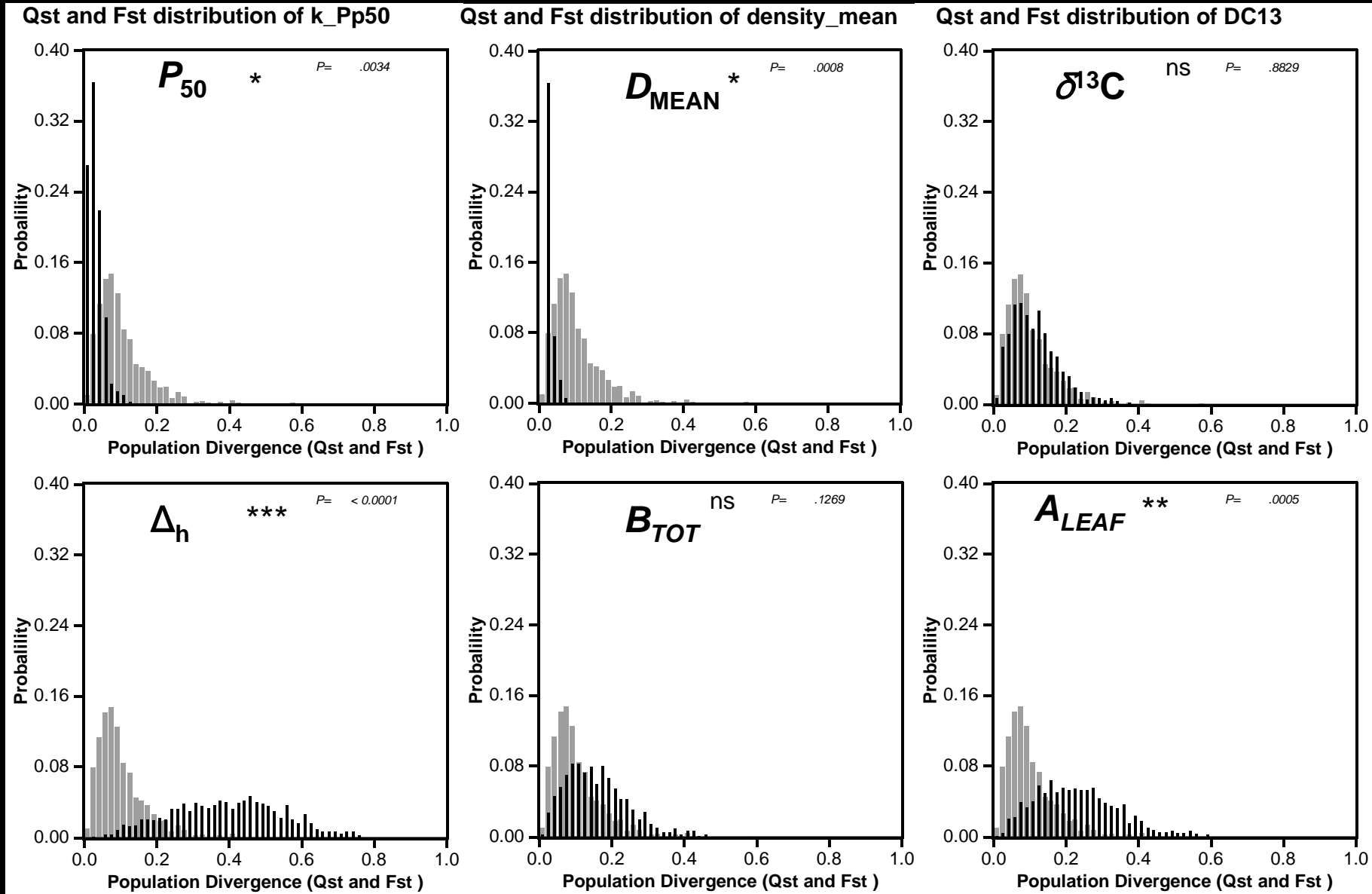

# Results et Discussion

Highly climatically contrasted populations  
No between-populations divergence

The first indirect proof in plant science of *uniform* selection across population

=>Canalized trait  
(very old stabilizing selection)

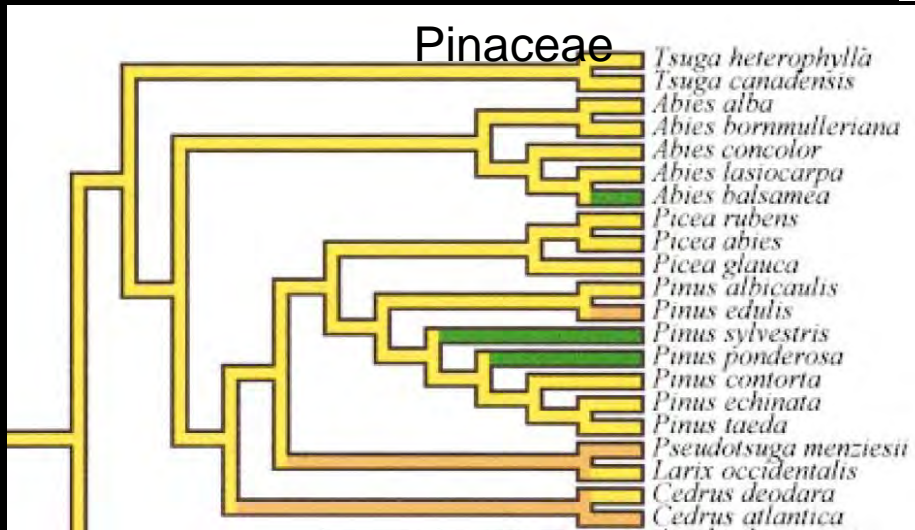
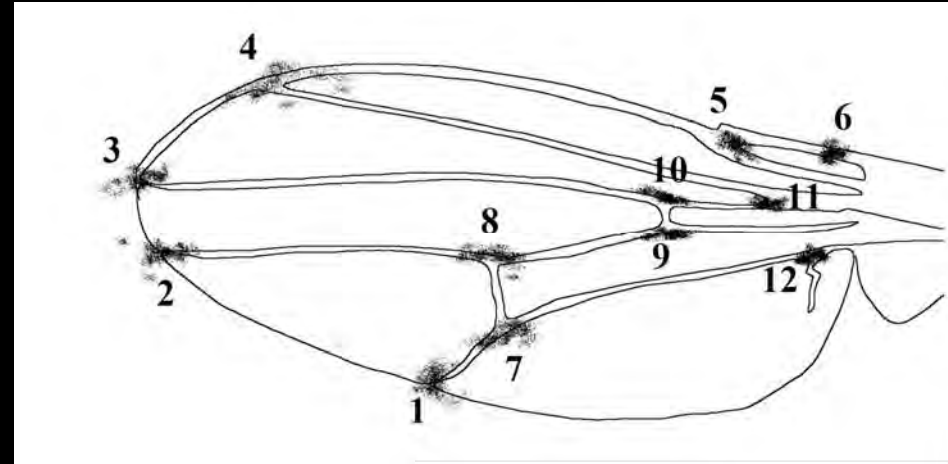

$\Psi_{50}$  (-MPa)

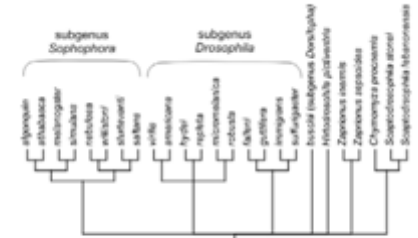
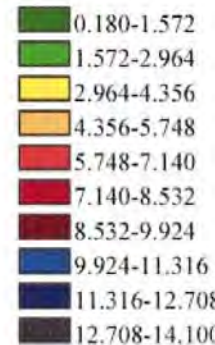



LALAQE HADRIEN

# Introduction

## Physiological process of cavitation

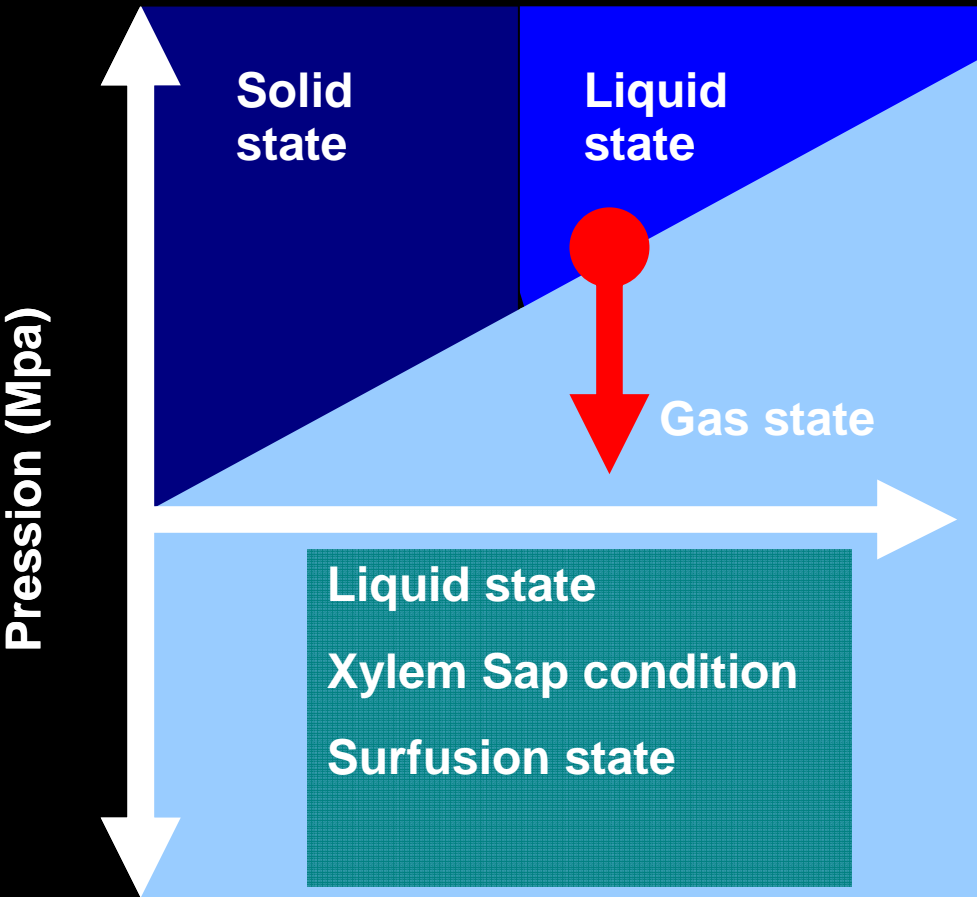

Temperature (K)

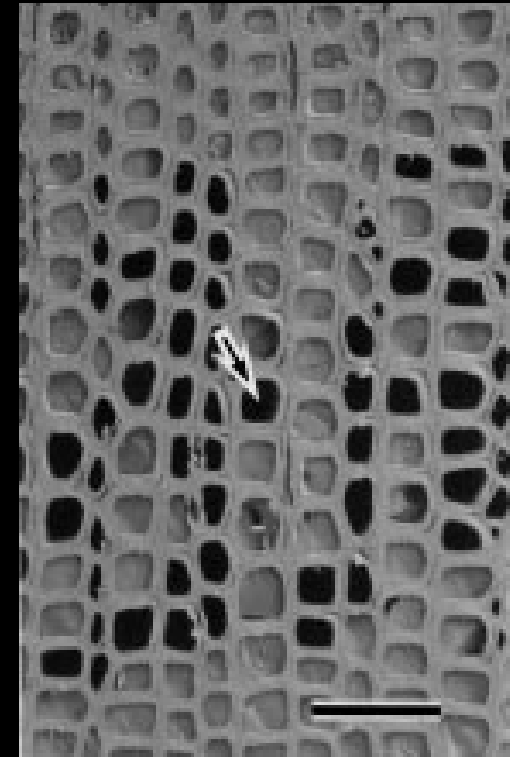

# Introduction

## Physiological process of cavitation

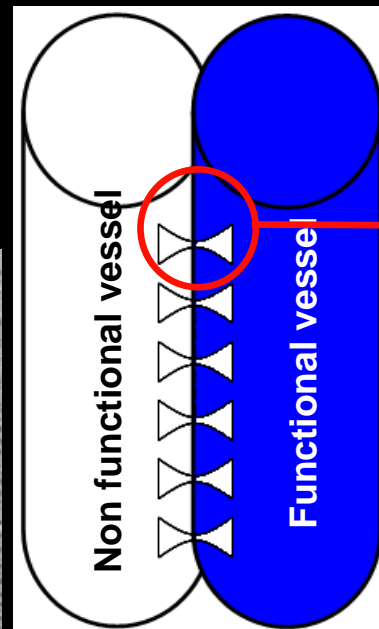
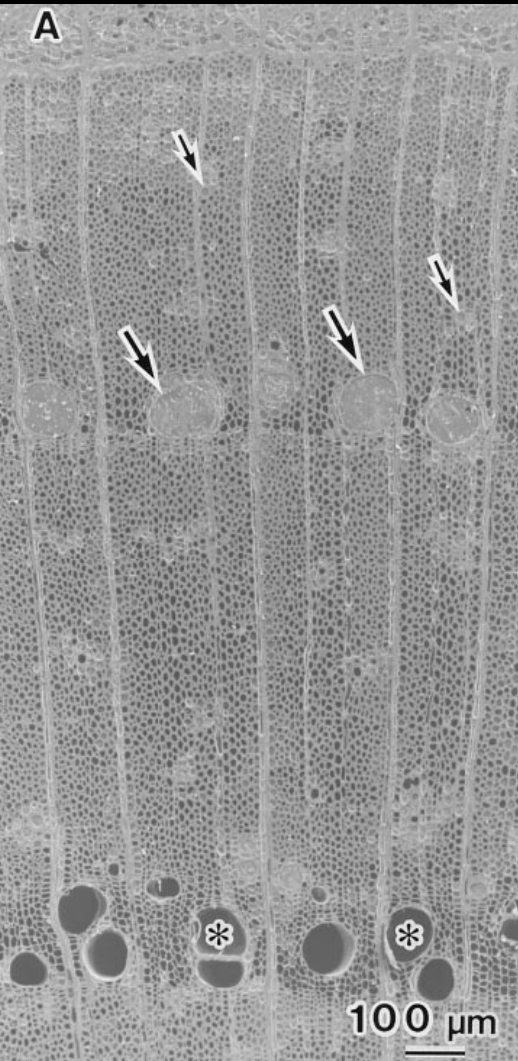

meniscus

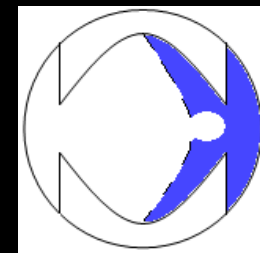
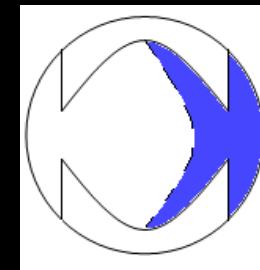
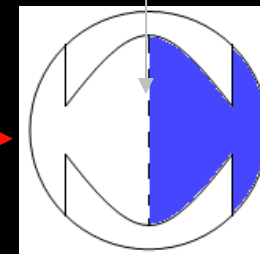

$$\Psi = -1 \text{ MPa}$$

$$\Psi = -2 \text{ MPa}$$

$$\Psi = -2,5 \text{ MPa}$$

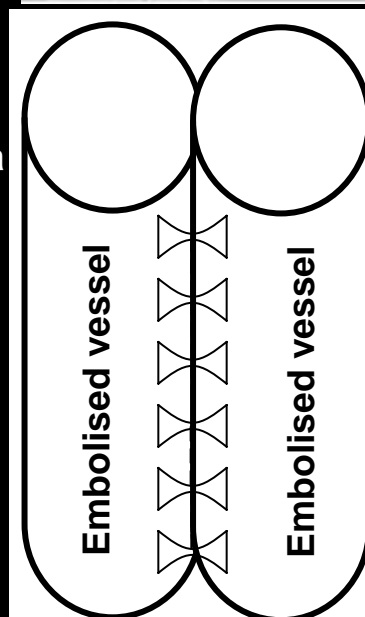
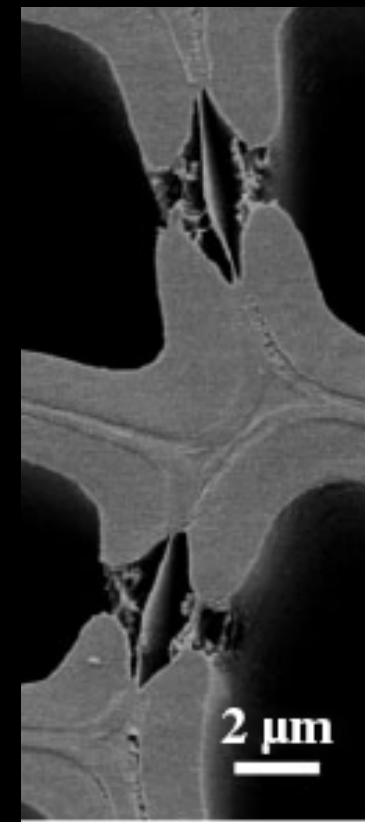

Tyree and Zimmermann 1996  
« Xylem Structure and the Ascent of Sap »

Utsumi et al 1996

# Hypothesis for embolism propagation in Gymnosperm

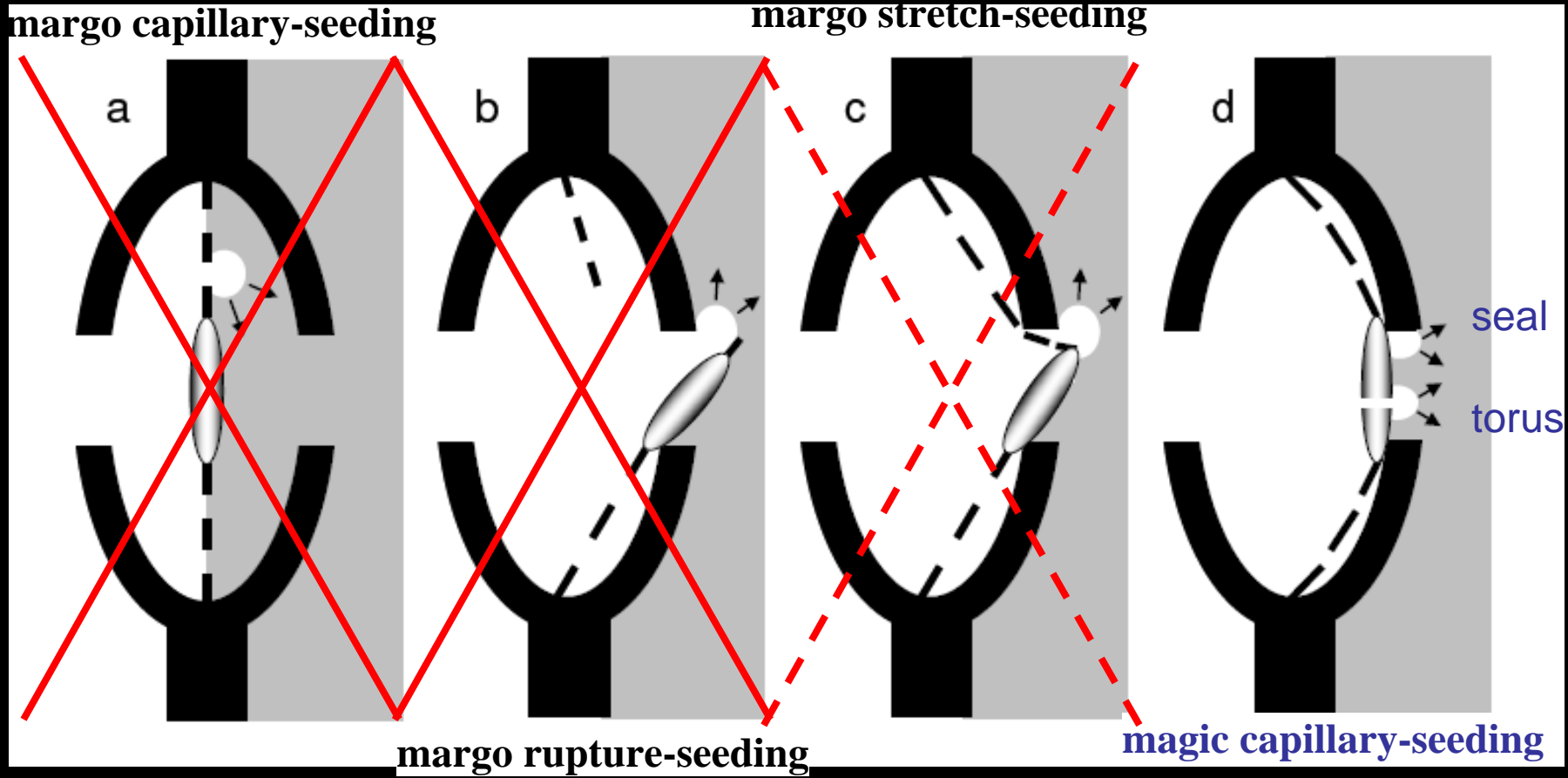

DP deflection < DP margo capillary seeding

no increase in conductance above the cavitation threshold

Higher margo flexibility = more cavitation resistant

Cochard & al 2009, Delzon et al 2010

# Introduction

## Physiological process of cavitation

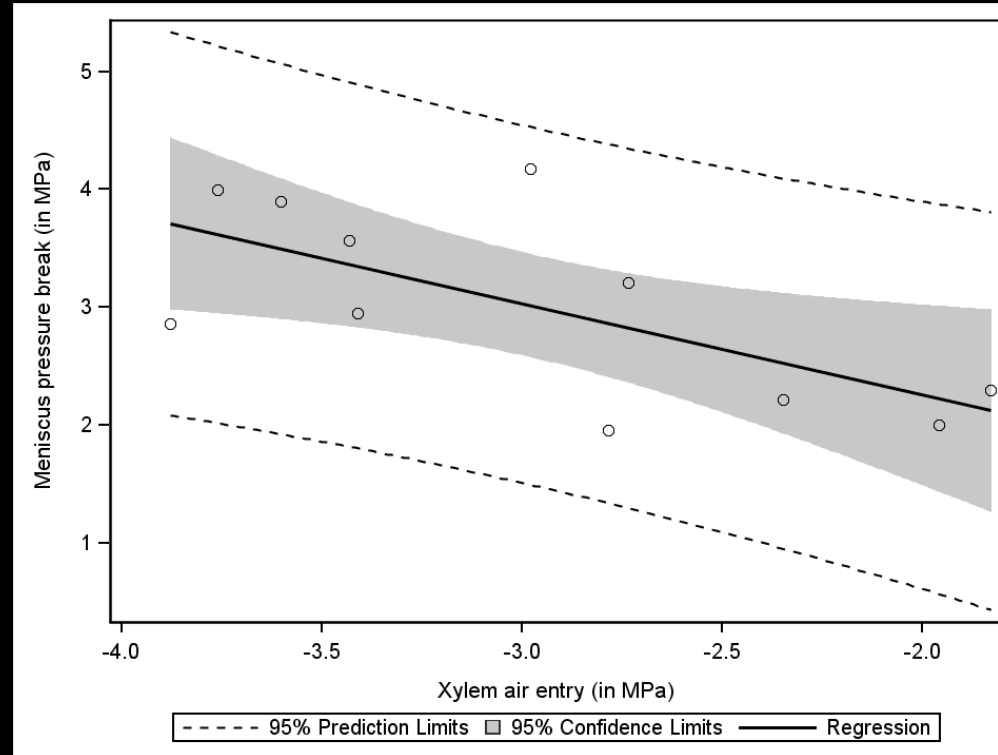
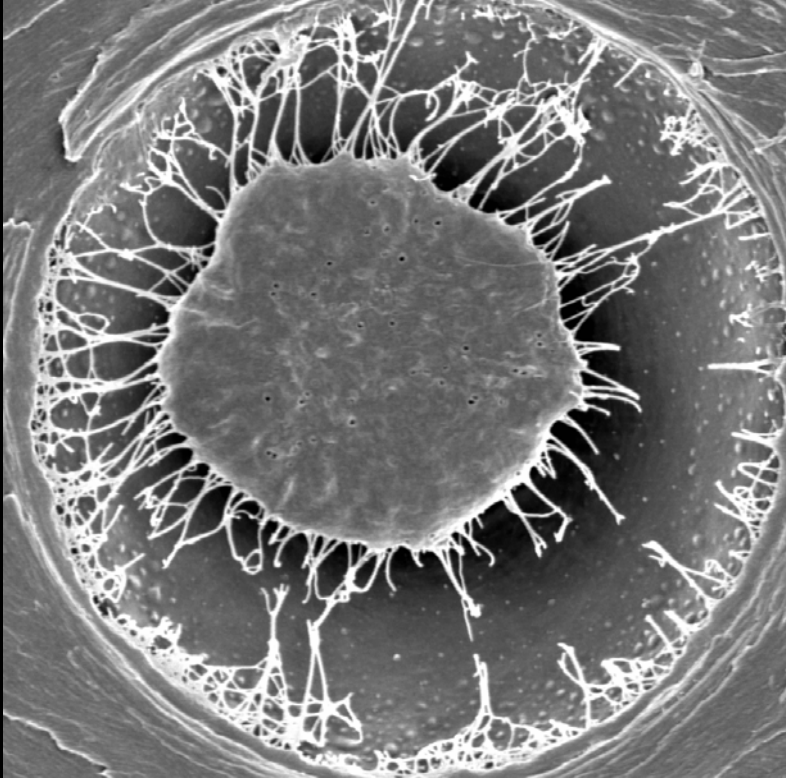

## Distribution of $F_{ST}$ ?

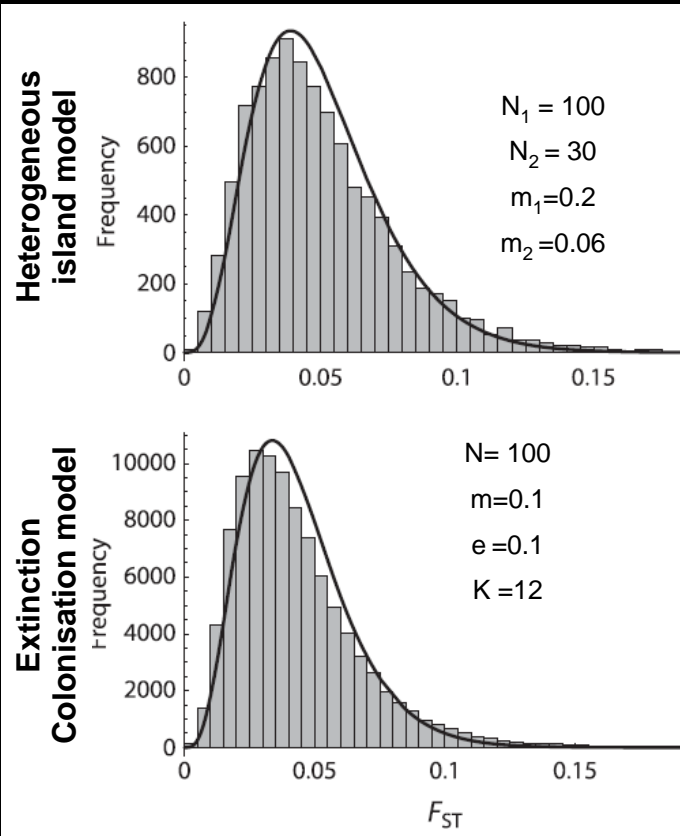

Whitlock 2008

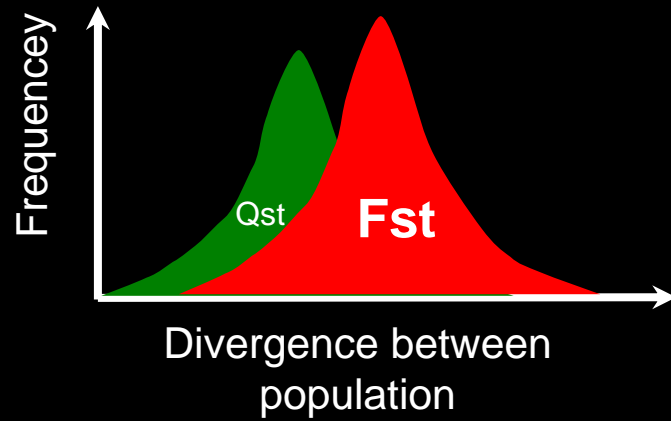

Approximation of  $F_{ST}$  distribution with Lewontin-Krakauer distribution

$$\hat{F}_{ST} = F_{ST}^* \times \frac{\text{random } \chi^2_{loci-1}}{df}$$



## Distribution of $Q_{ST}$ ?

Bad performance of classical methods

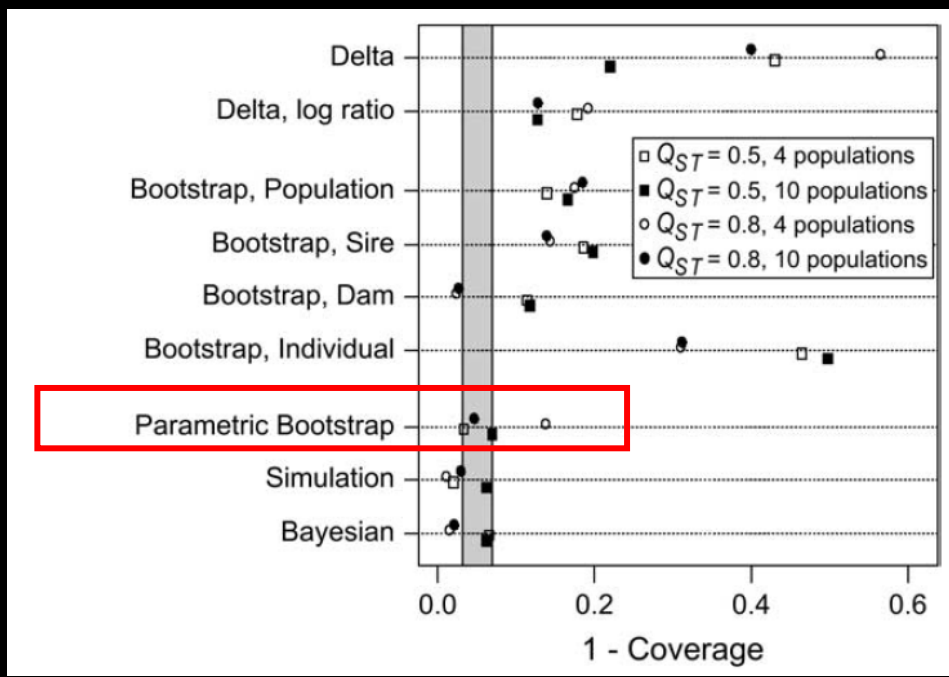

O'Hara et al 2005

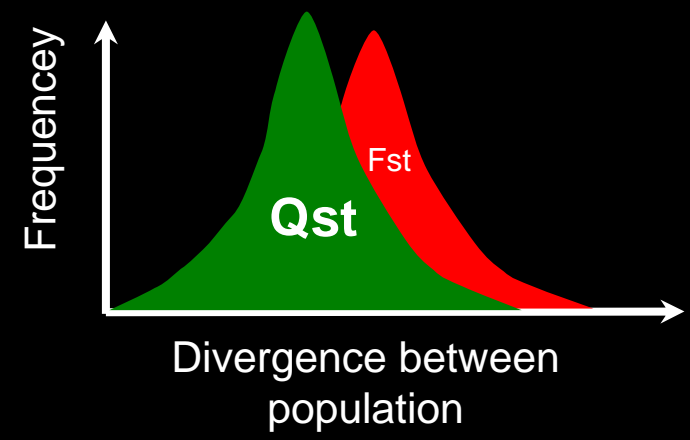

AN APPROXIMATE DISTRIBUTION OF ESTIMATES OF VARIANCE COMPONENTS

F. E. SATTERTHWAITE

*General Electric Company, Ft. Wayne, Indiana*

$$\hat{V}_i = V \frac{\chi^2_{df_{effective}}}{df_{effective}} \quad \text{with}$$

$$df_{effective} = \frac{df_{observed} - 1}{1 + \frac{2V^2}{nV_{I-1}^2} + \left(\frac{V^2}{V_{I-1}^2}\right)^2 \left[ \frac{1}{n^2 + \frac{I-1}{n^3I - n^2}} \right]}$$

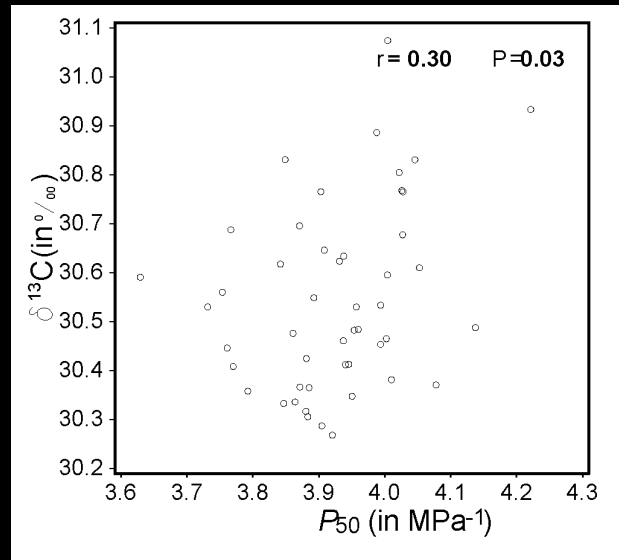
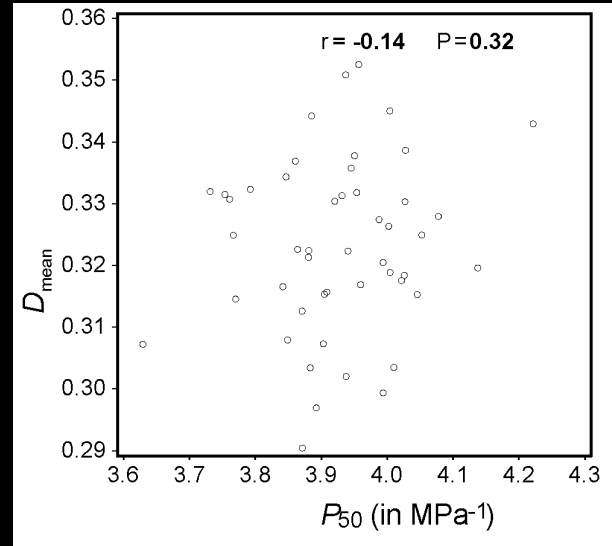
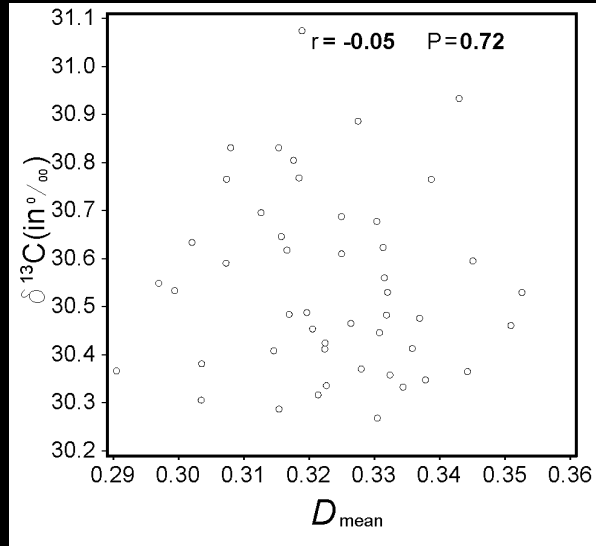

Characters	$h^2_{ns}$	SE	$CV_A$	$CV_{BP}$	$CV_R$	$CV_P$
		$h^2_{ns}$				
P50	0.438	0.117	4.4	1	6.7	6.6
$\delta^{13}C$	0.21	0.067	1.3*	0.6*	3.4*	2.2*
$\Delta h$	0.363	0.080	16.2	18.8	2	26.9

Lamy & al 2010 in prep

It is possible to select more cavitation resistance genotype, but the gain could be limited by the amount of additive variance

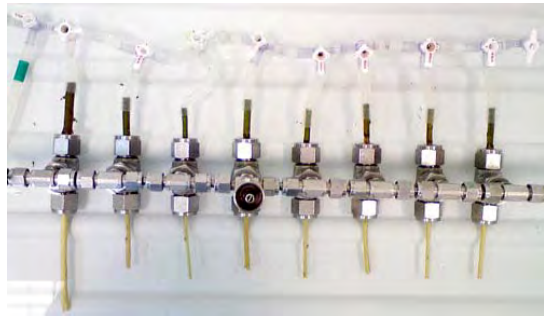

## ***How reliable is vulnerability to cavitation measurement on Quercus ilex***

Nicolas Martin, Damien Longepierre, Roland Huc, Hervé Cochard, Serge Rambal

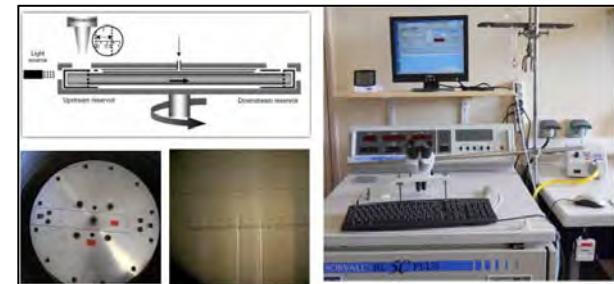

# Why? Climate change etc...

- 25 to 30% des précipitations 2100

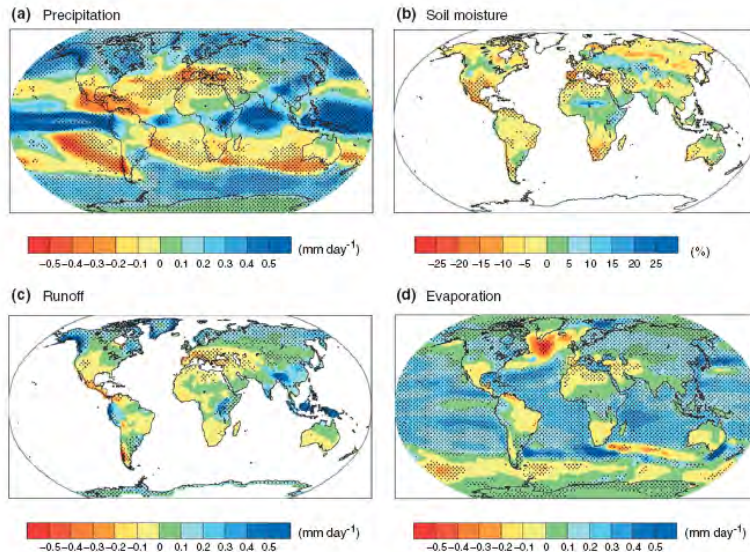

Aiguo 2010

- 25 to 50% Mediterranean bassin  
(d) Precipitation change, B2-Ref, JJA, %

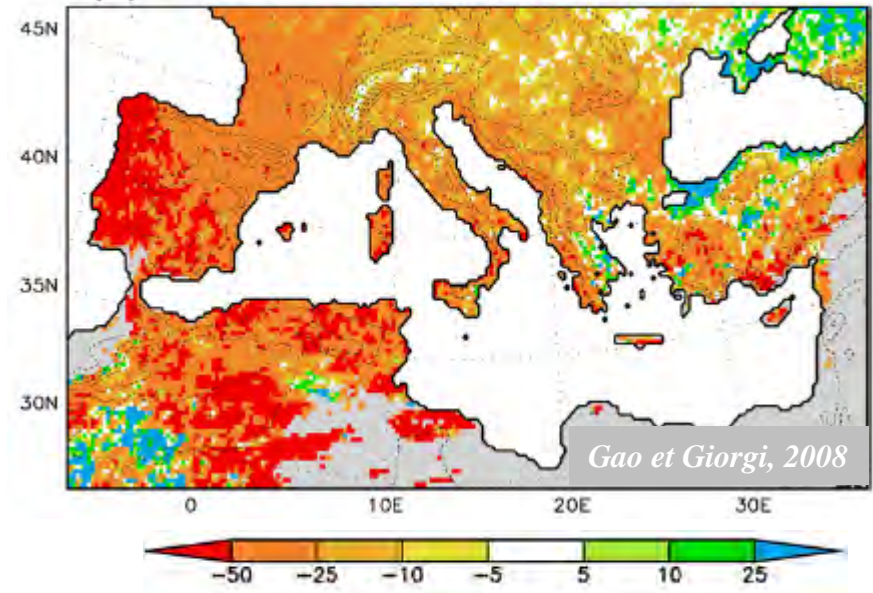

- How will Mediterranean forests respond to climate change? → Trees die-off, Carbon Budget..

- How pertinent traits will vary with adverse conditions?

- Widespread Mediterranean species : *Quercus ilex*

# Why? Climate change etc...

- 25 to 30% des précipitations 2100

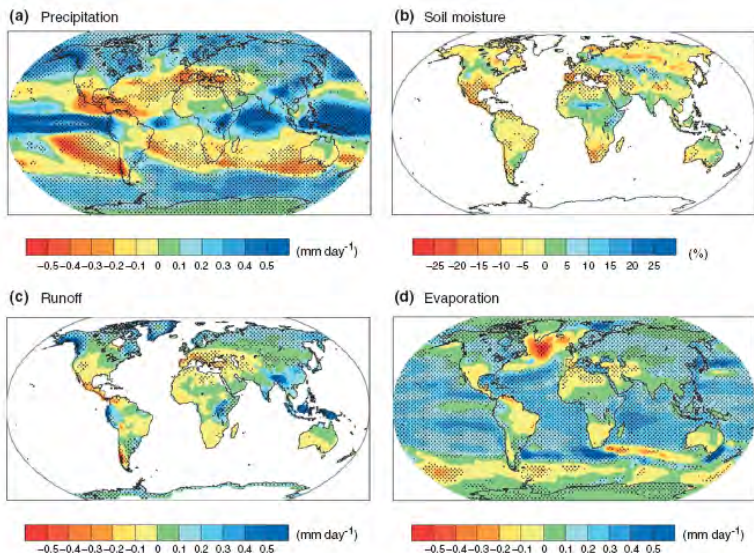

Aiguo 2010

- 25 to 50% Mediterranean bassin

(d) Precipitation change, B2-Ref, JJA, %

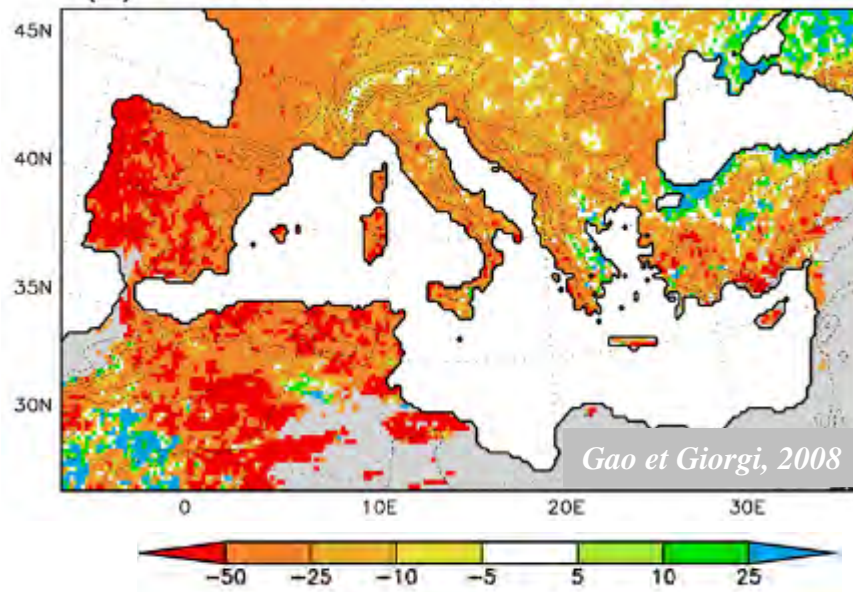

- How will Mediterranean forests respond to climate change? → Trees die-off, Carbon Budget..

- How pertinent traits will vary with adverse conditions?

- Widespread Mediterranean species : *Quercus ilex*

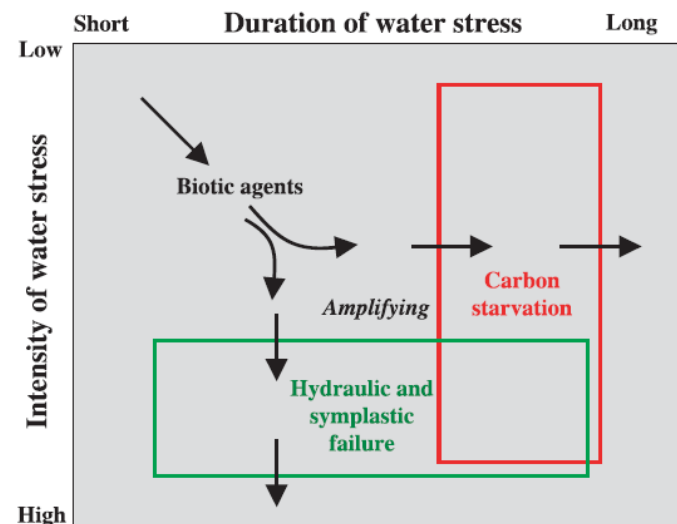

McDowell, Pockman et al, 2008

# Vulnerability to drought and pertinent traits

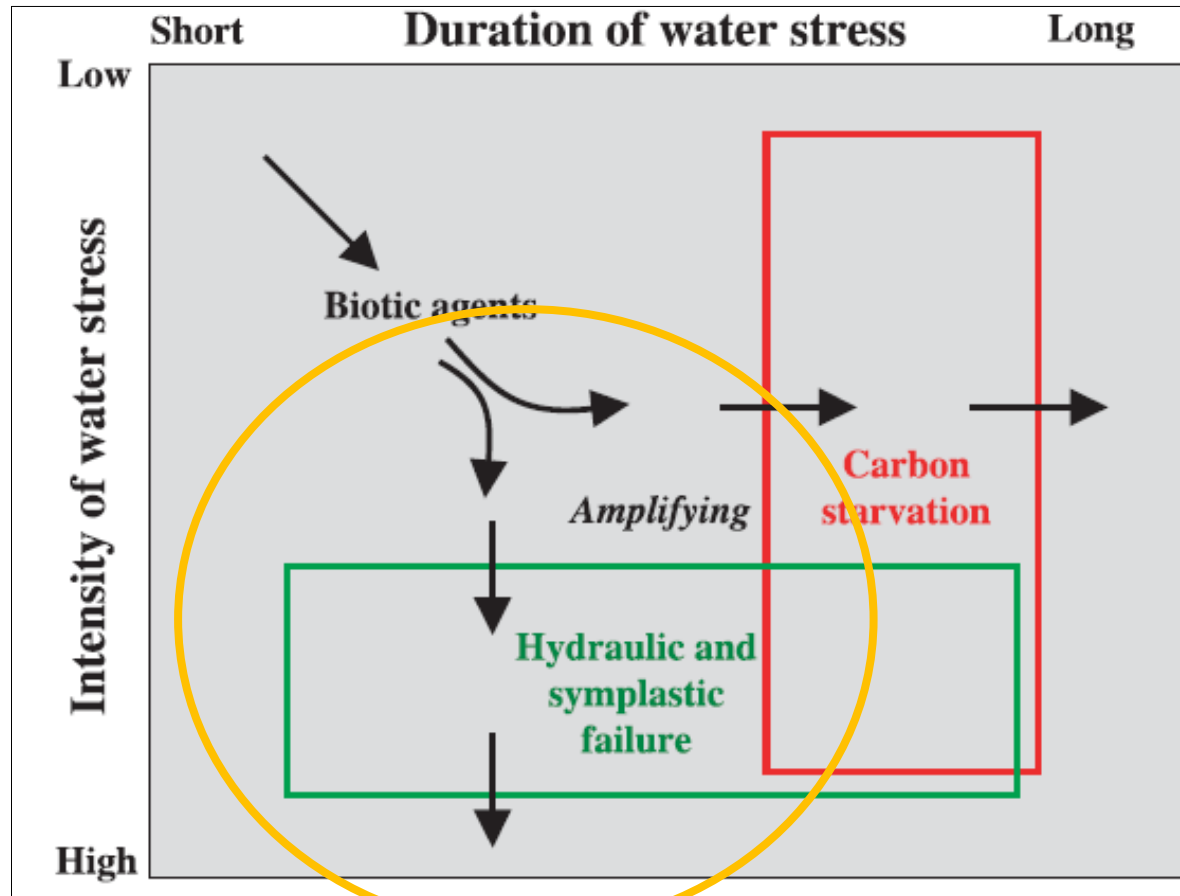

McDowell, Pockman et al, 2008

Traits related to vulnerability to cavitation are of growing interests

How reliable are their measures ? on *Quercus ilex*...

# A brief littérature survey and some basics rules

Discrepancies between between field measurement and laboratory analysis

Biblio Qilex

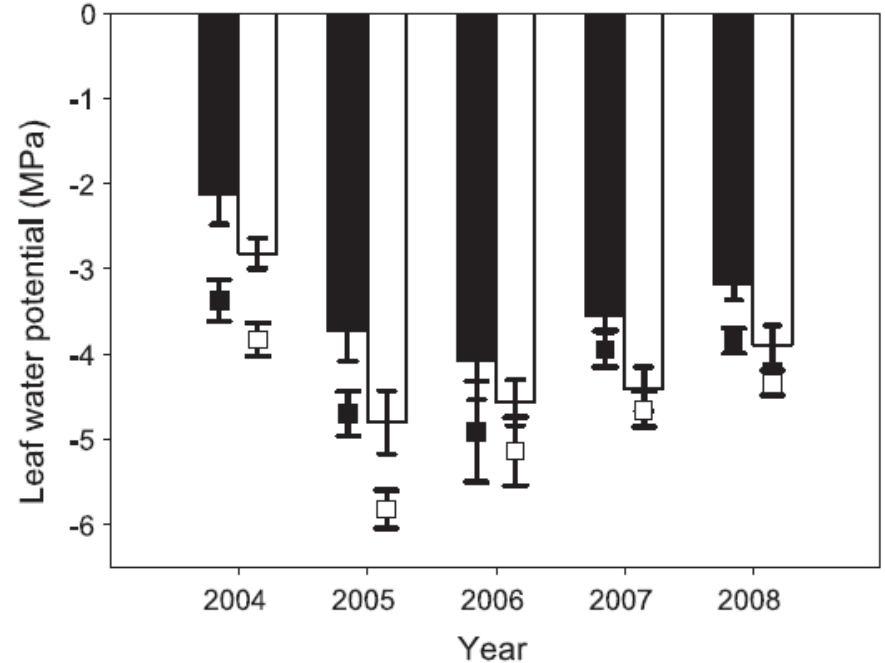
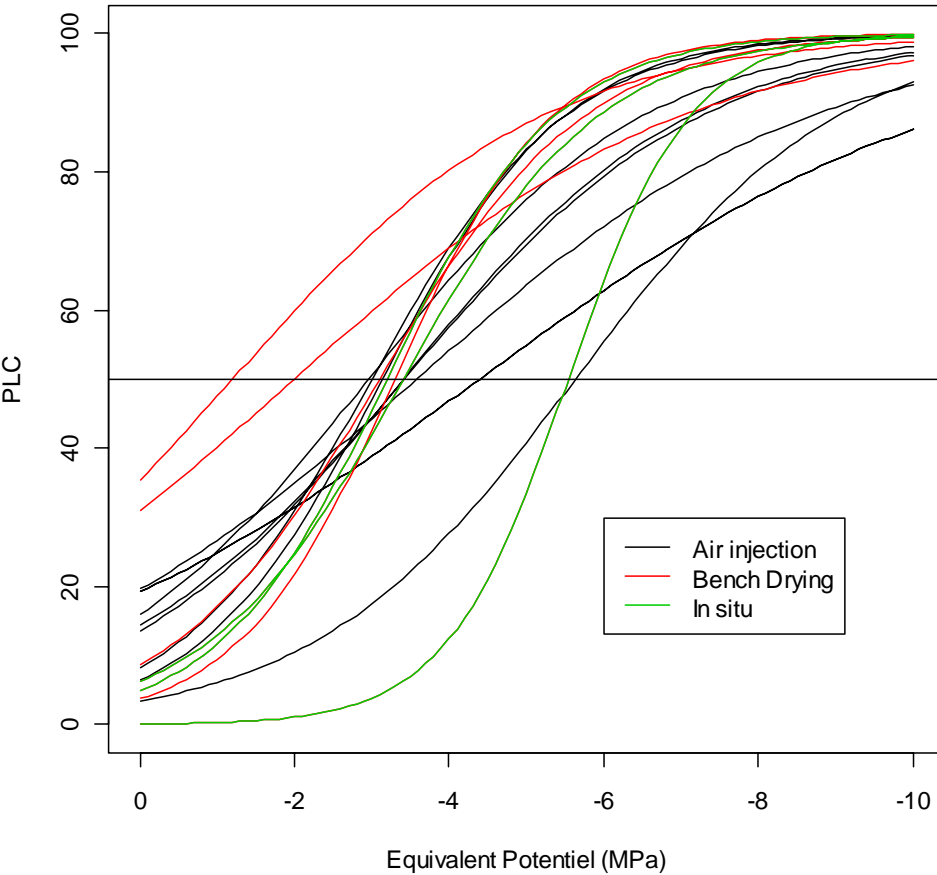

**Psi min = - 4.50 (Mpa)**

*Tyree & Cochard 1996* : [...]a correlation between vulnerability to cavitation and other traits of drought resistance holds except for where *Q.ilex* [...]



# A brief littérature survey and some basics rules

## *Quercus ilex* : Démon darwinien?

**Biblio Qilex**

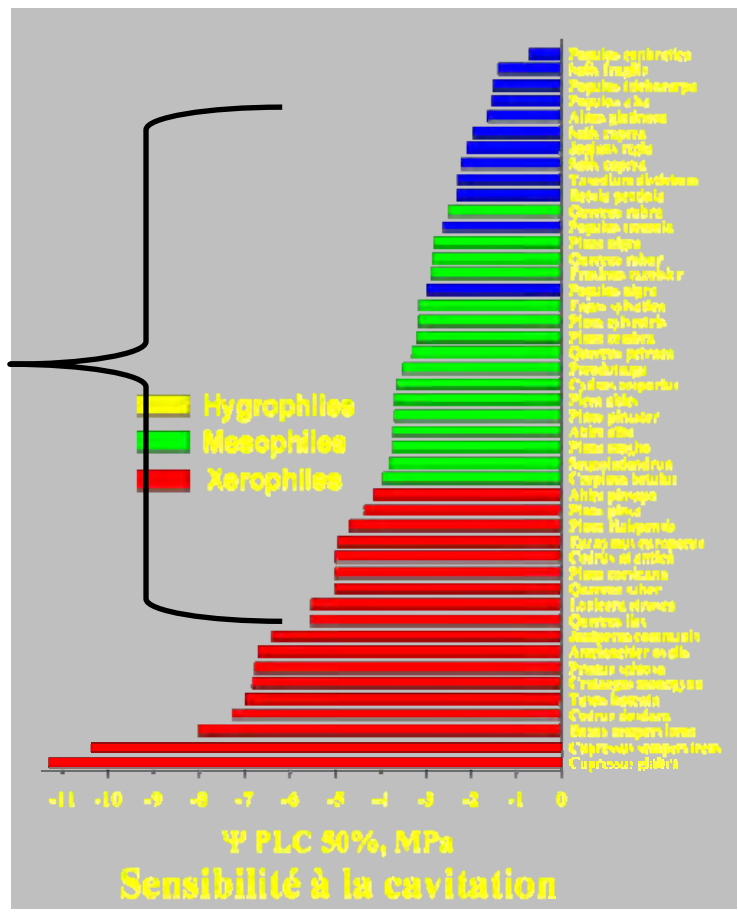
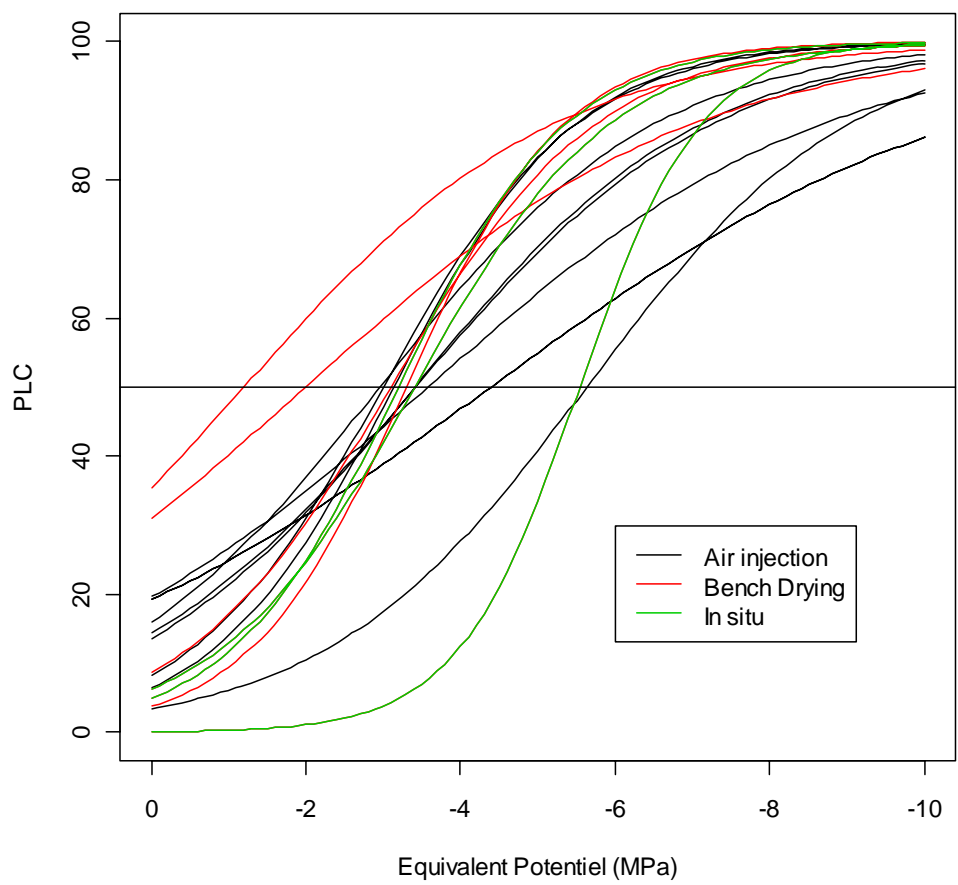

# Sample length problems?

Biblio Qilex

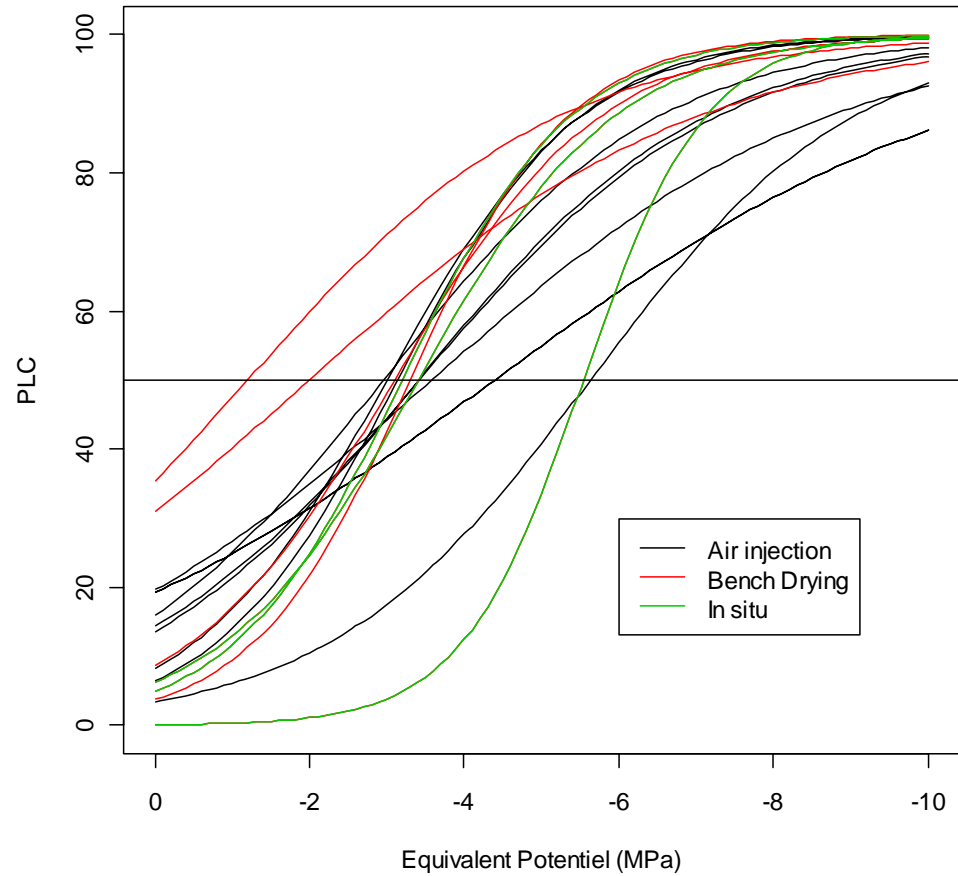

?

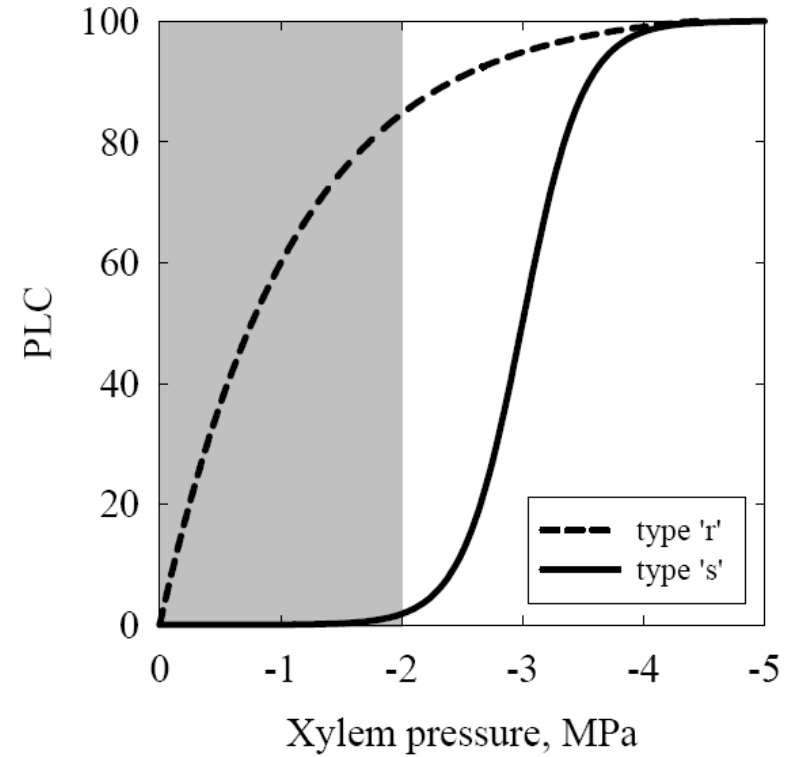

Cochard et al 2010

Maximal vessel length > 1.5 m

# Sample length problems?

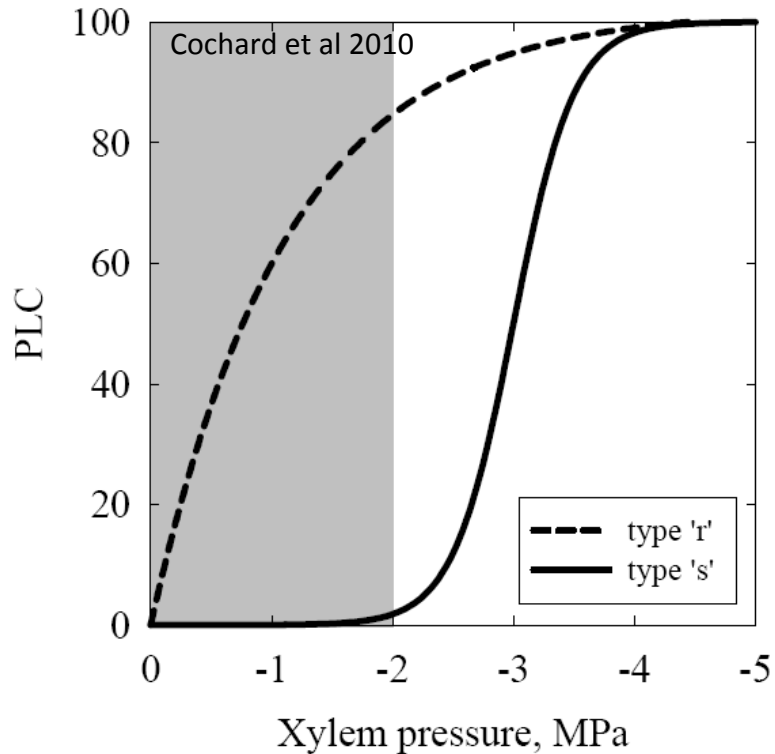

Ring porous

*Fraxinus excelsior*

$-2.86 \pm 0.67$

$-3.84 \pm 2.27$

*Quercus ilex*

$-5.52 \pm 0.96$

$-4.13 \pm 7.45$

*Quercus robur*

$-2.83 \pm 0.08$

$-2.08 \pm 0.67$

P50 Cochard *et al.* 2005

*Vitis vinifera*

-

$-0.75 \pm 0.19$

*Celtis australis*

-

$-1.65 \pm 0.54$

# Sample length problems?

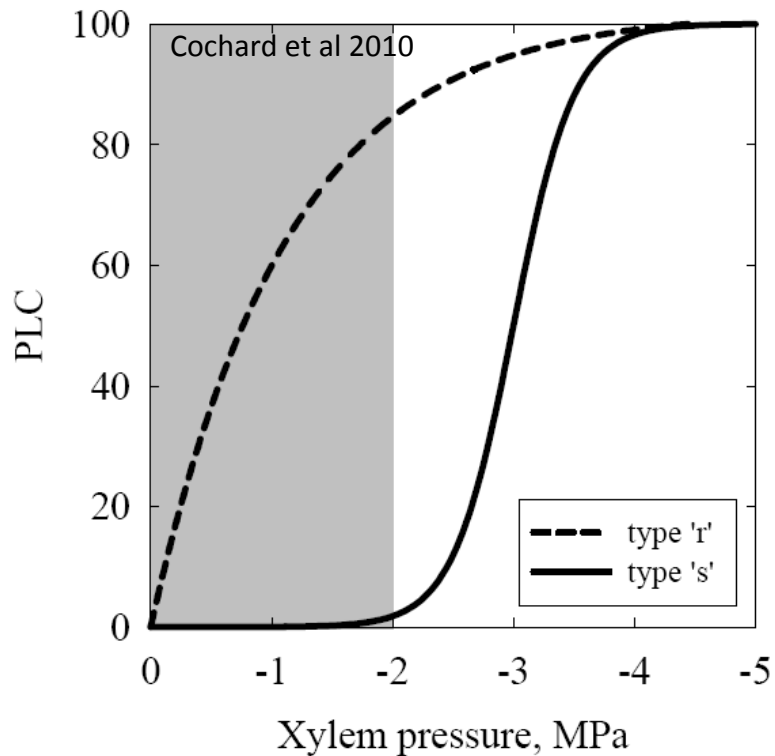

Obvious with the CAVITRON

What about other methods?

Ring porous

*Fraxinus excelsior*

$-2.86 \pm 0.67$

$-3.84 \pm 2.27$

*Quercus ilex*

$-5.52 \pm 0.96$

$-4.13 \pm 7.45$

*Quercus robur*

$-2.83 \pm 0.08$

$-2.08 \pm 0.67$

P50 Cochard *et al.* 2005

*Vitis vinifera*

-

$-0.75 \pm 0.19$

*Celtis australis*

-

$-1.65 \pm 0.54$

# Sample length problems? *Methods comparison*

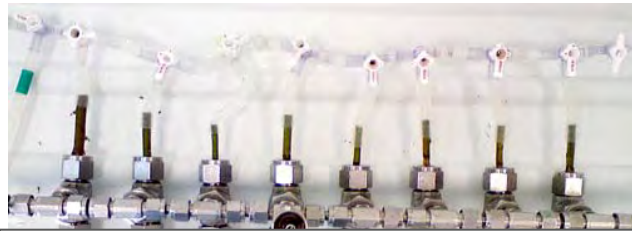

Air injection method

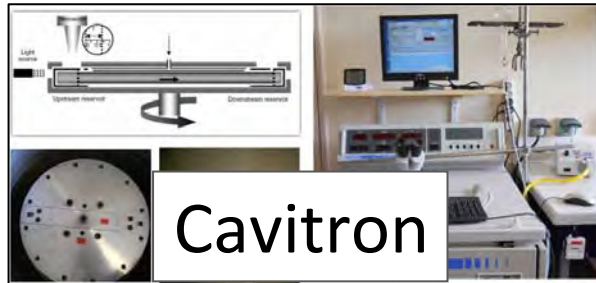

Cavitron



Reference air  
drying methods

How consistent with :

- 1/ Minimum water potential value -4.50 MPa
- 2/ The R/S shaped curves

# Sample length problems? *Methods comparison*



## Stems

Bench Drying reference methods :

**>2 meters long stems**

**New apical shoots (current year)**



## Resprouts : few water stressed

Bench Drying reference methods :

**>2 meters long stems**

**CAVITRON**

**28 cm**

Double ended pressurisation method

**15 to 25 cm**

# Methods comparison : Dehydration reference method **Stems**

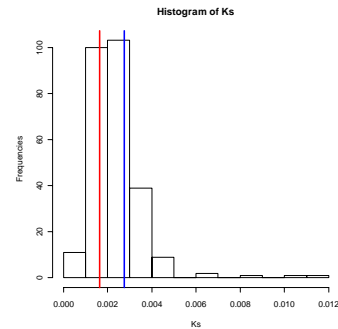
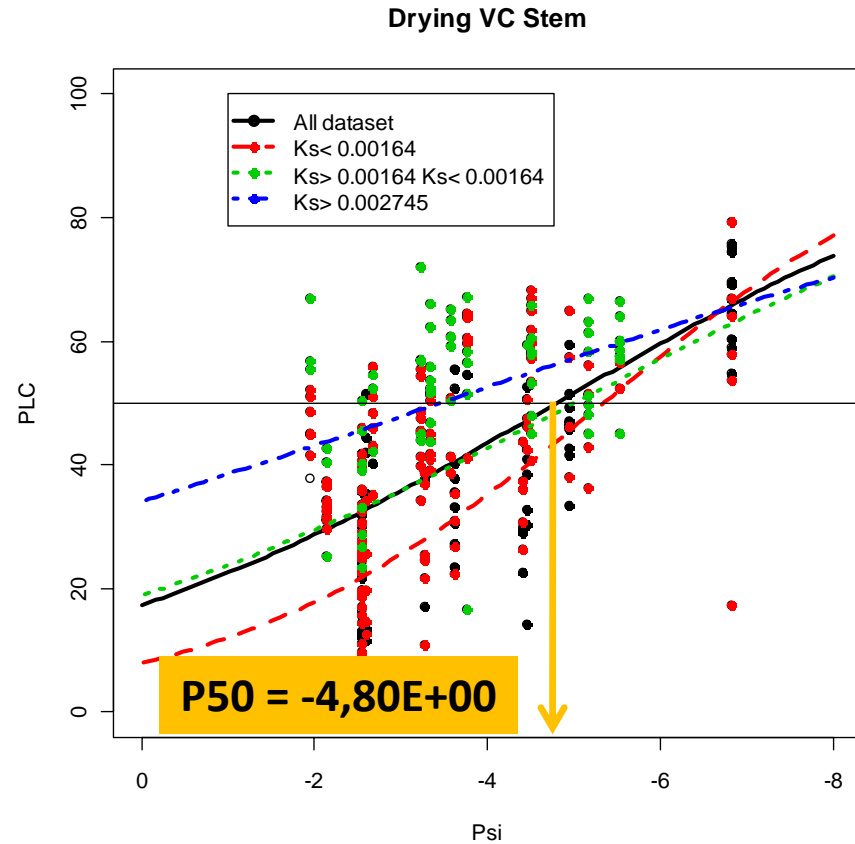

Not very «  $S$  », very noisy:

- ? Interaction between water stress and phenology & growth

- High native embolism

- However, P50 consistent

# Methods comparison : Dehydration reference method **resprouts**



Few native embolism

$\Psi_{\min}$  during the season = -1.7

VC Resprout Bench Drying

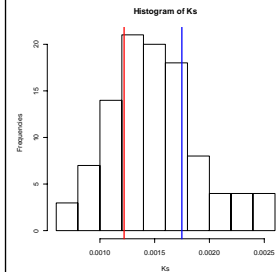
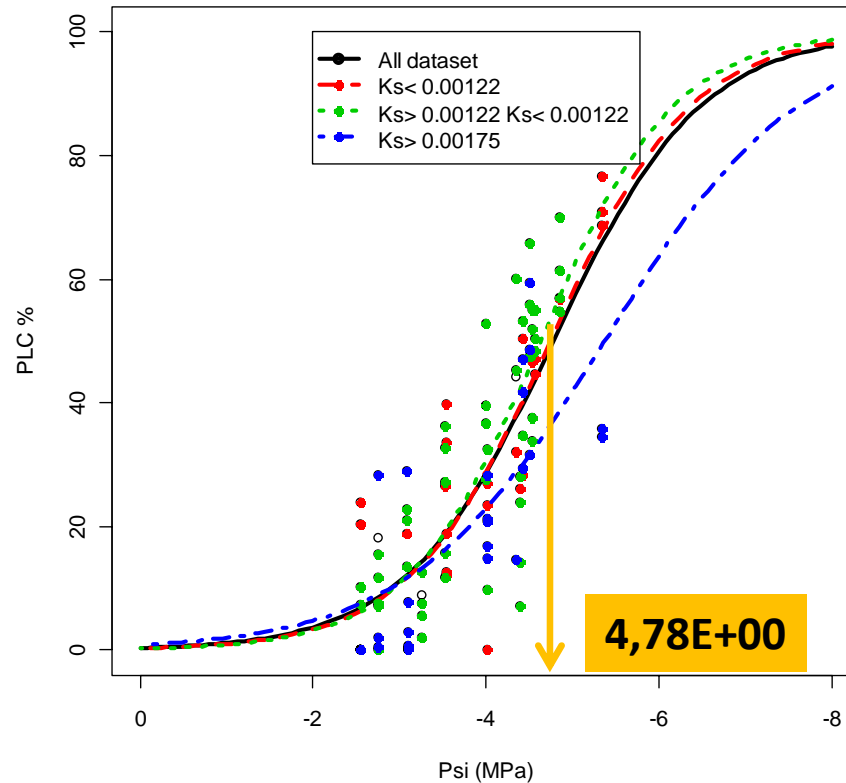

**CLEANER !!**

**P50 in accordance with dehydration method on stems**



# Methods comparison : Cavatron on resprouts

*<1 year old resprouts*

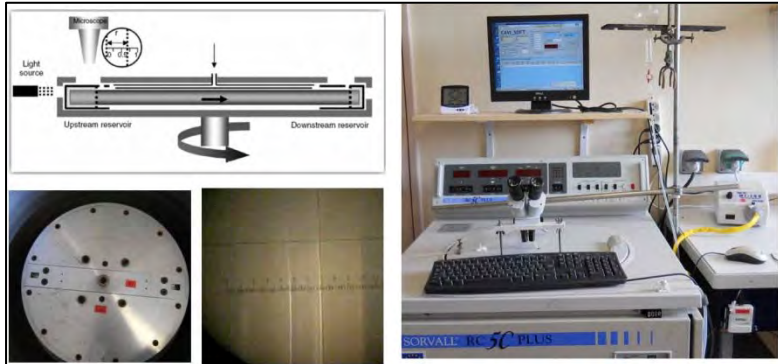
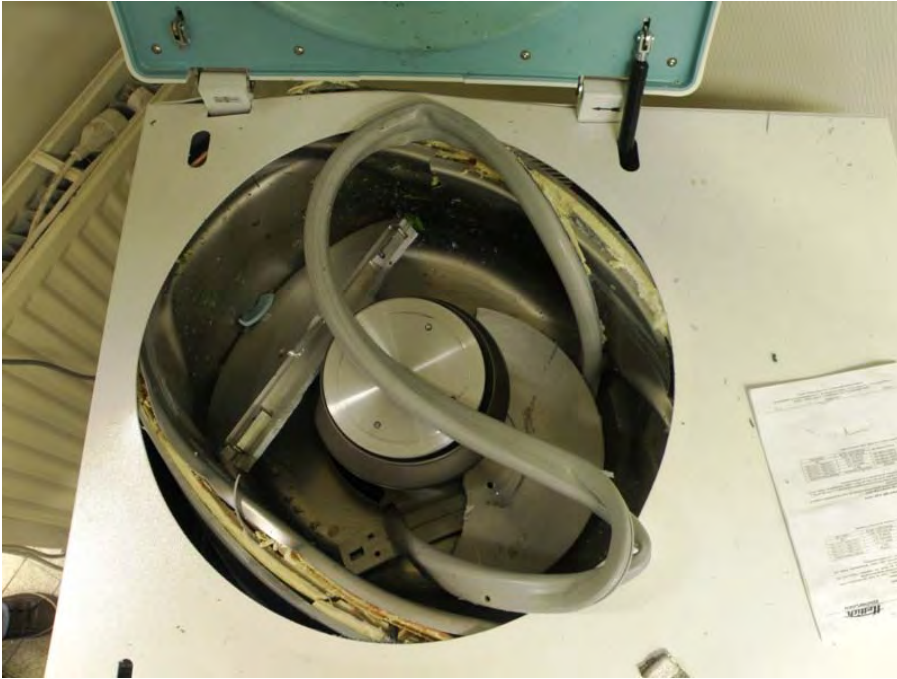

# Methods comparison : Cavatron on resprouts

**<1 year old resprouts**

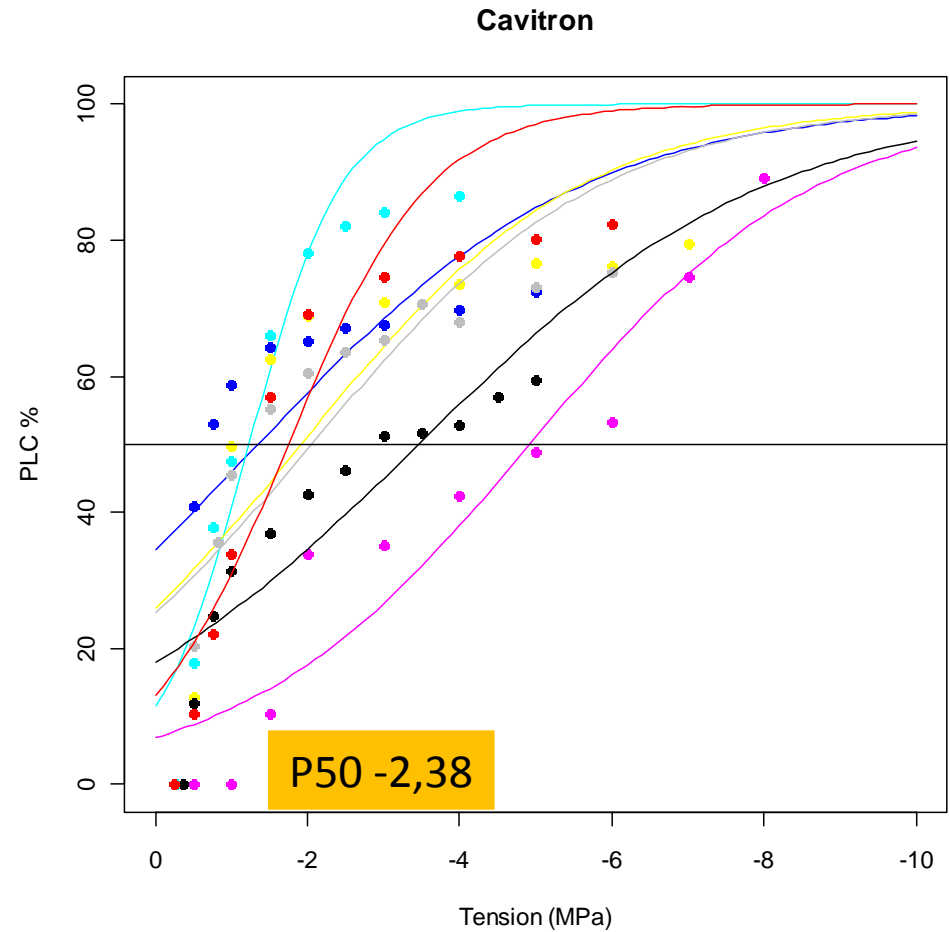

**Clearly R shaped curves**  
**Weak P50**  
**OK...**

# Methods comparison : Air injection on resprouts



**Length : 15 & 22 cm**  
**Different diameters**

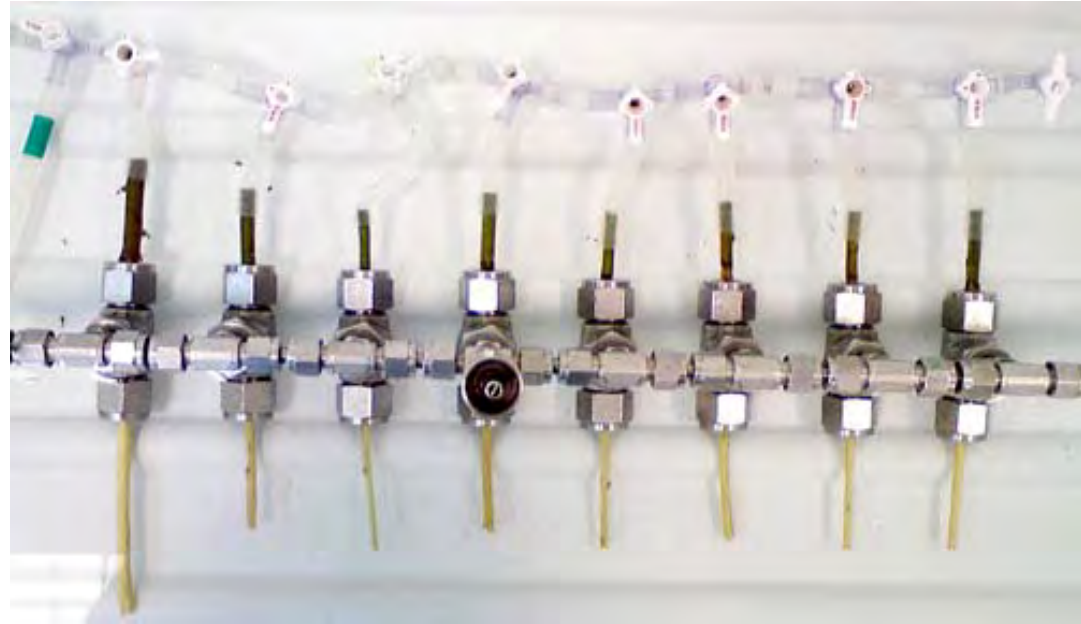

# Methods comparison : Air injection on resprouts

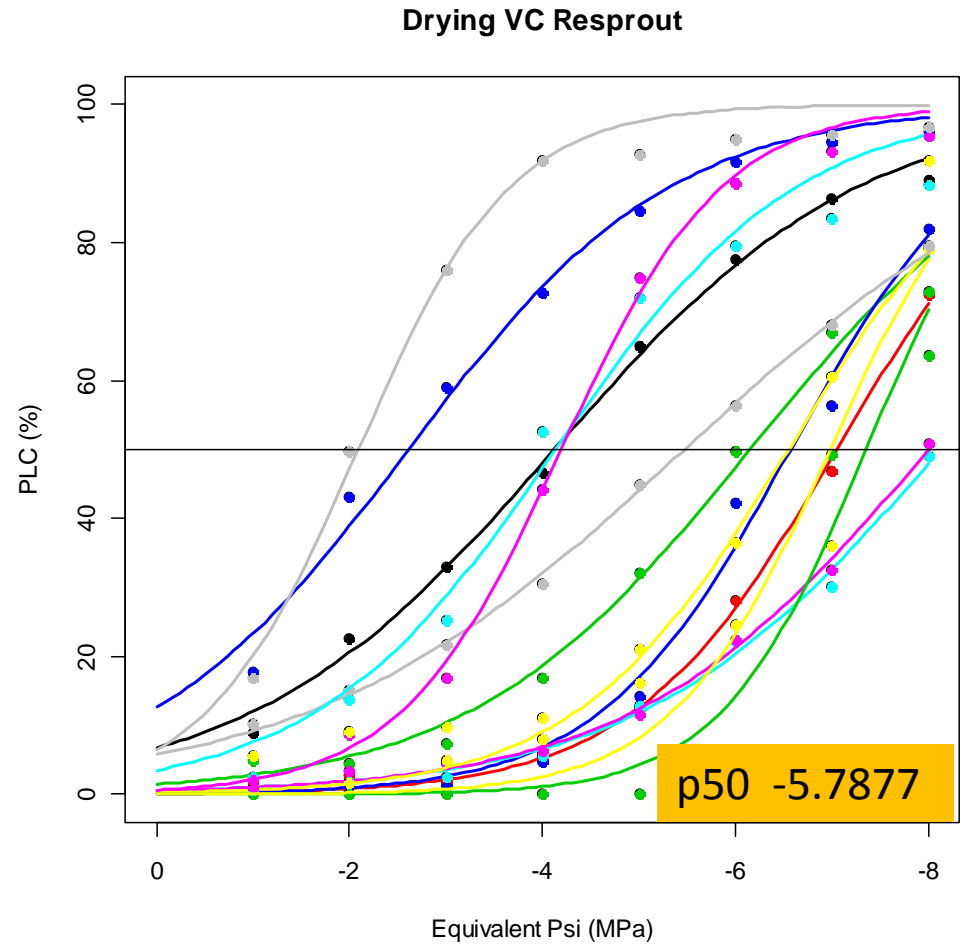

**Very high variability**  
**Unconsistent with the reference method**

# Sum up

VC Resprout Bench Drying

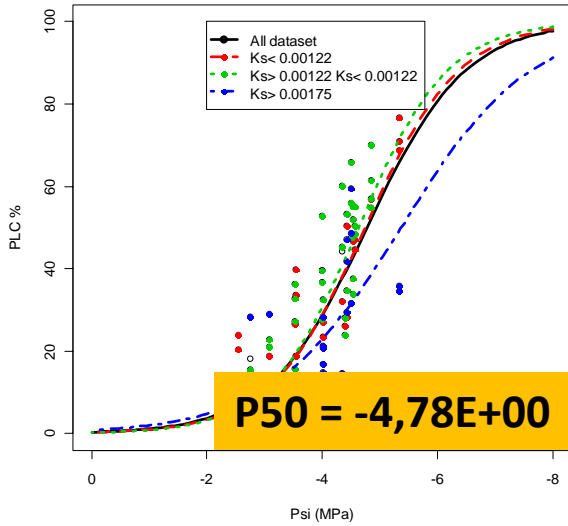

OK

±OK

Drying VC Stem

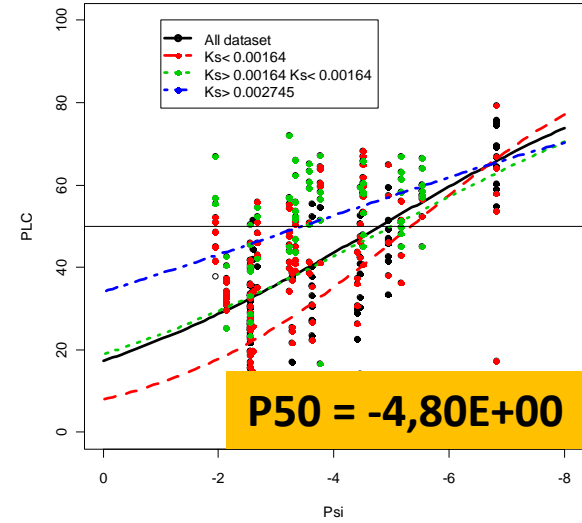

Cavitron

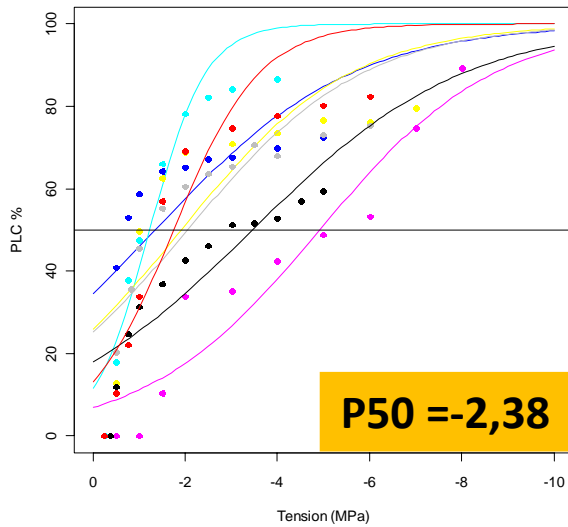

NON

...

Drying VC Resprout

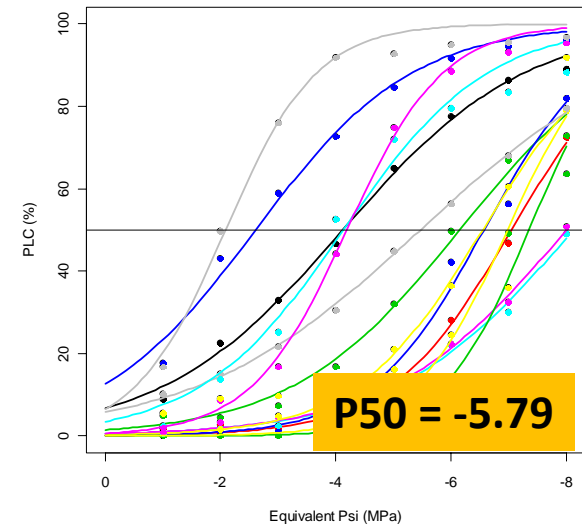

# What happened with air injection?

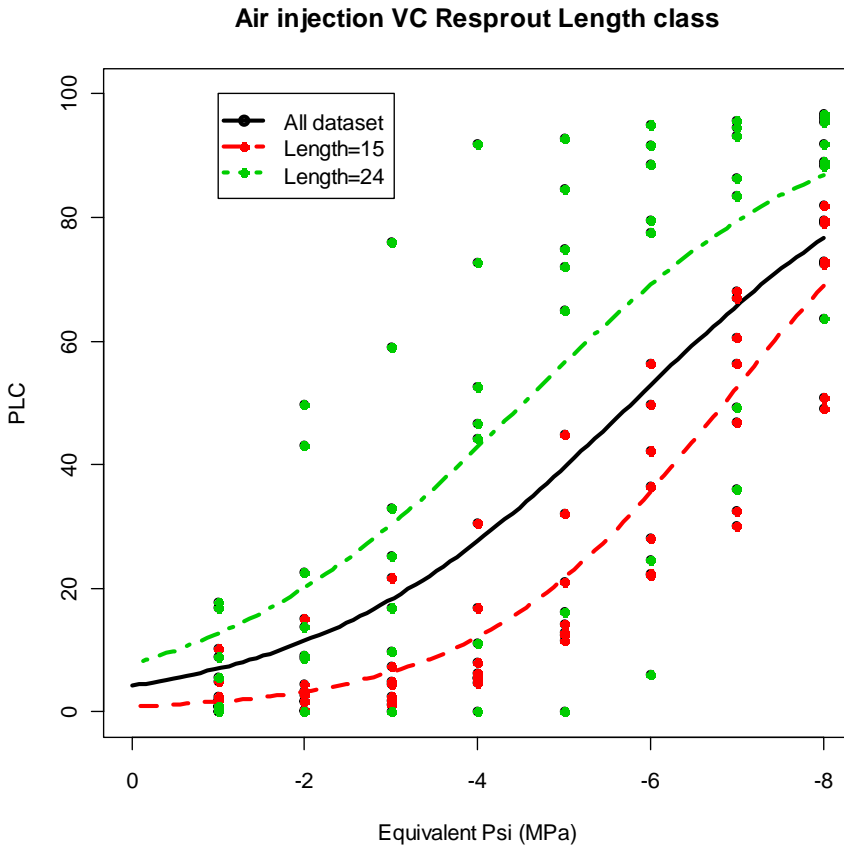

**Higher length = More « R shaped» & vulnerable ?**

# What happened with air injection?

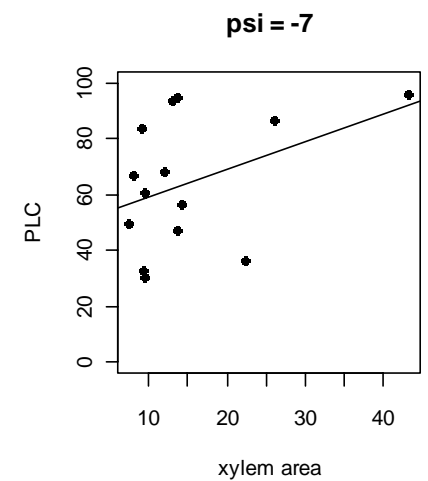
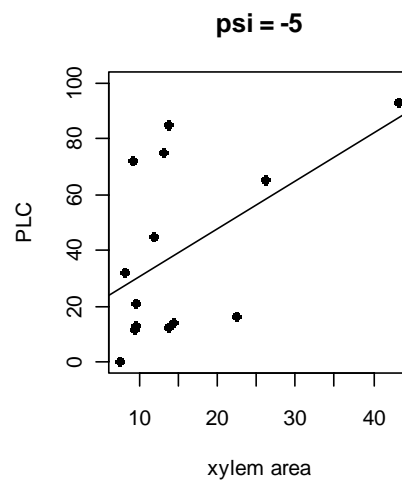
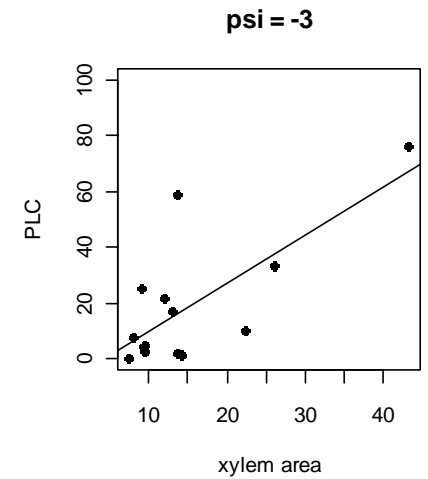
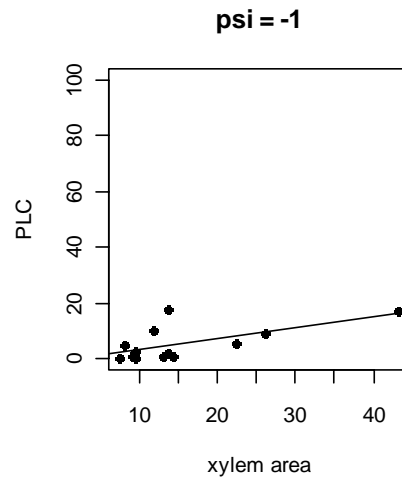
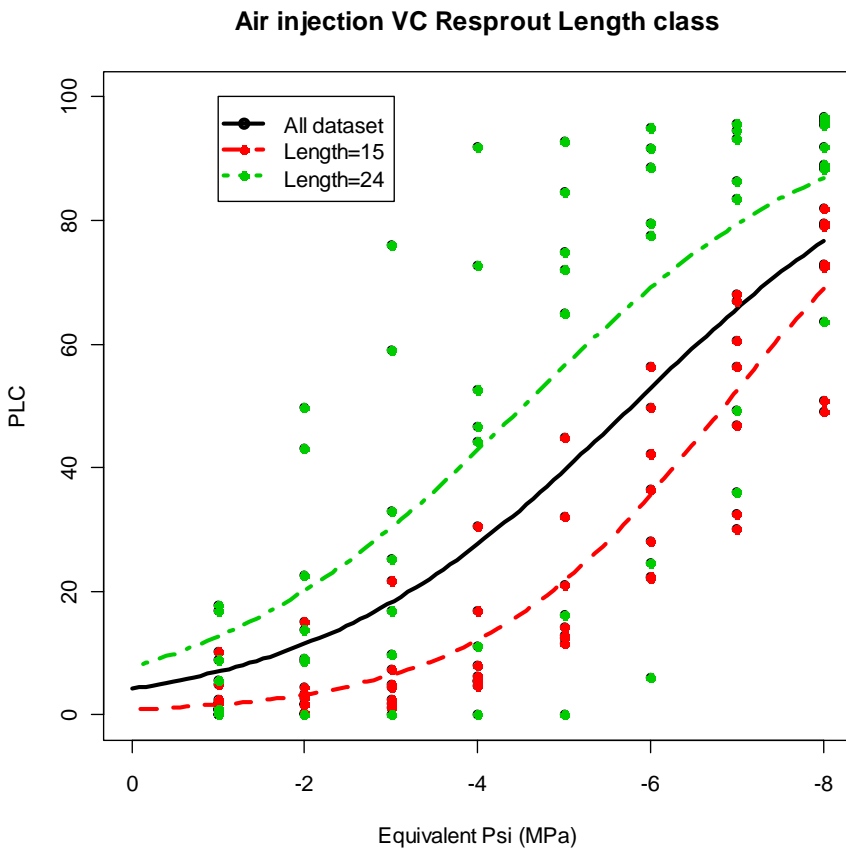

**Effect of size distributions**

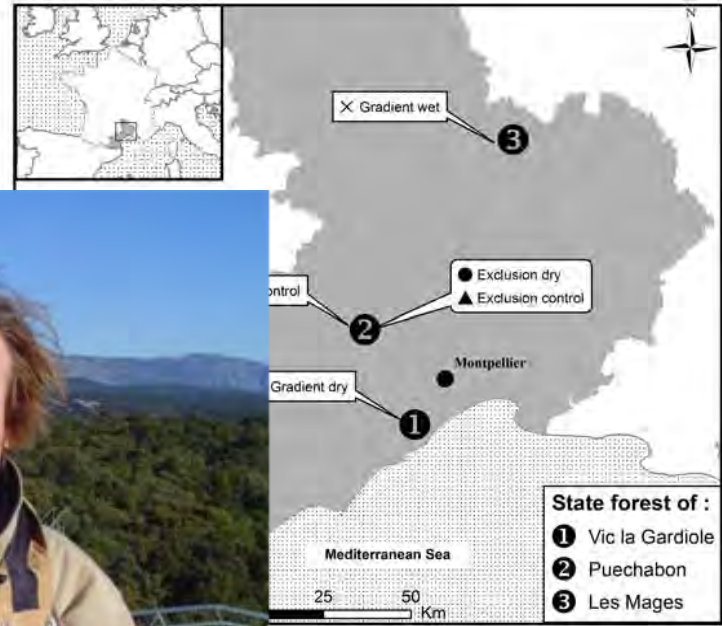

Thanks for your attention

Thanks to my supervisor *Laurent Misson...*





# XYLEM GROUP MEETING

Nancy, April 2011

## Establishment of hydraulic control of expansion during leaf ontogeny in *Arabidopsis thaliana*

Florent PANTIN<sup>1</sup>

François BARBIER<sup>1</sup>

André LACOINTE<sup>3</sup>

Geneviève CONÉJÉRO<sup>2,4</sup>

Colette TOURNAIRE-ROUX<sup>2</sup>

Christophe MAUREL<sup>2</sup>

Bertrand MULLER<sup>1</sup>

Thierry SIMONNEAU<sup>1</sup>

Technical support

Crispulo BALSERA<sup>1</sup>

Myriam DAUZAT<sup>1</sup>

Gaëlle ROLLAND<sup>1</sup>

1



lepse  
Montpellier

2



b.pmp  
& Montpellier

3



INRA

Centre de Recherches  
de Clermont-Fd-Therix



UNIVERSITÉ CLERMONT-FERRAND

Université Blaise Pascal

U.M.R. PIAF

4





# Hydraulic control of leaf growth

- > Leaf expansion: a major component of plant performance
  
- > A key role for hydraulics in the control of growth
  - ✓ Plant hydraulic properties are coordinated with relative growth rates, gas exchanges, and species evolution [SACK & HOLBROOK, 2006; McKOWN et al., 2010]
  
  - ✓ Growth is among the first processes affected by water stress [HSIAO, 1973]
  
  - ✓ Cell growth is driven by water relations [LOCKHART, 1965; ORTEGA, 1985]
  
  - ✓ This holds true at the organ level [e.g. BOYER, 1968; BEN HAJ SALAH & TARDIEU, 1997; BOYER & SILK, 2004; BOUCHABKE et al., 2006; ORTEGA, 2010]

# Hydraulic control of leaf growth

> Leaf expansion: a major component of plant performance

> A key role for hydraulics in the control of growth

- ✓ Plant hydraulic properties are coordinated with relative growth rates, gas exchanges, and species evolution [SACK & HOLBROOK, 2006; McKOWN et al., 2010]
- ✓ Growth is among the first processes affected by water stress [HSIAO, 1973]
- ✓ Cell growth is driven by water relations [LOCKHART, 1965; ORTEGA, 1985]
- ✓ This holds true at the organ level [e.g. BOYER, 1968; BEN HAJ SALAH & TARDIEU, 1997; BOYER & SILK, 2004; BOUCHABKE et al., 2006; ORTEGA, 2010]

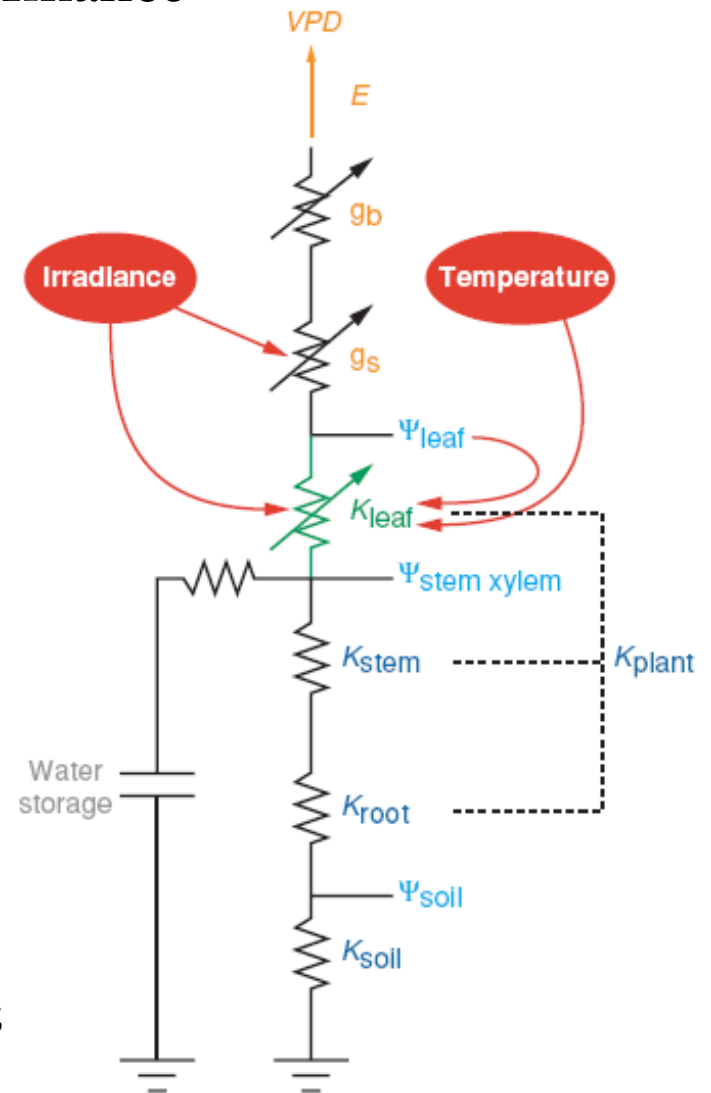

# Hydraulic control of leaf growth

> Growth depressions during the daytime have been attributed to hydraulics in the literature

Plant Physiol. (1997) 114: 893–900

## Control of Leaf Expansion Rate of Droughted Maize Plants under Fluctuating Evaporative Demand<sup>1</sup>

A Superposition of Hydraulic and Chemical Messages?

Halim Ben Haj Salah and François Tardieu\*

Institut National de la Recherche Agronomique, Laboratoire d'Ecophysiologie des Plantes sous Stress Environnementaux, 34060 Montpellier, France

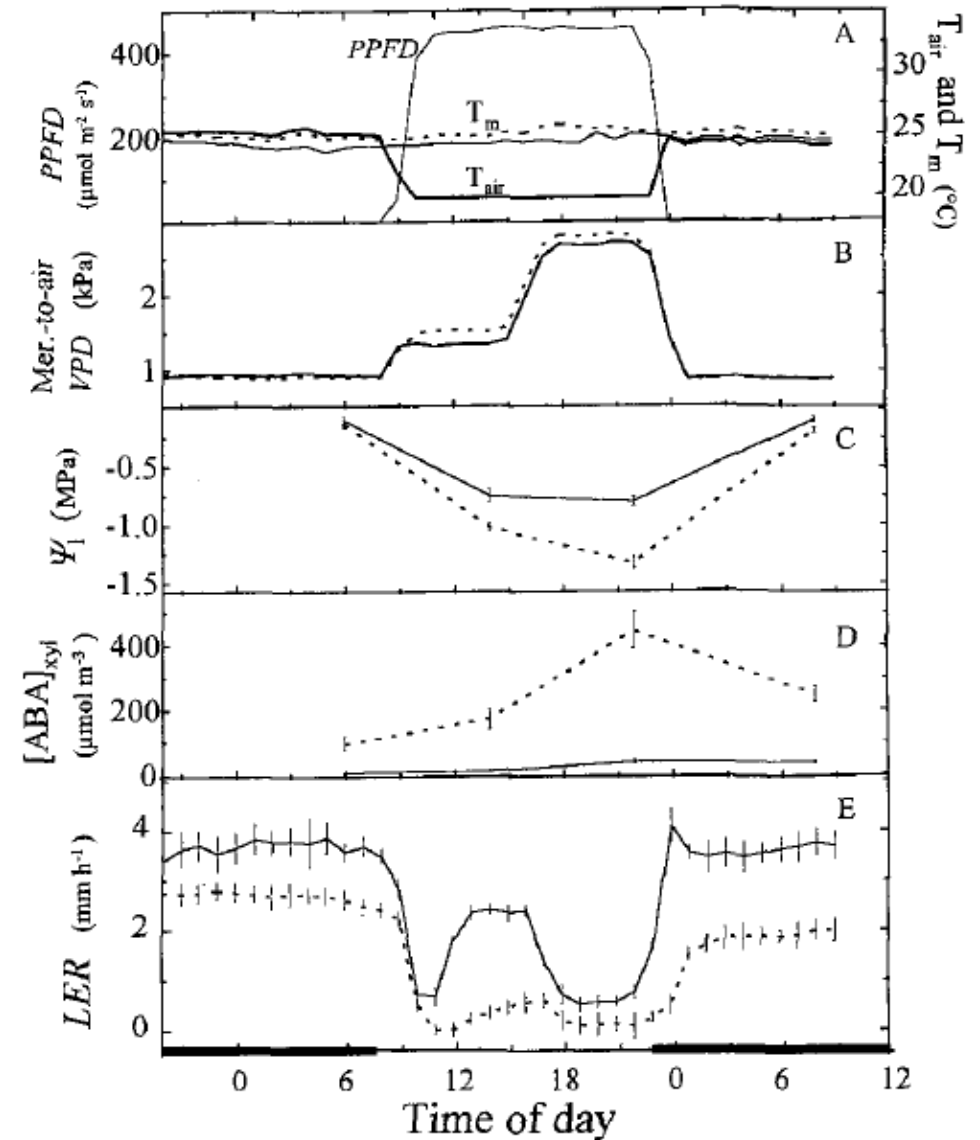

# Hydraulic control of leaf growth

> Growth depressions during the daytime have been attributed to hydraulics in the literature

Plant Physiol. (1997) 114: 893–900

## Control of Leaf Expansion Rate of Droughted Maize Plants under Fluctuating Evaporative Demand<sup>1</sup>

A Superposition of Hydraulic and Chemical Messages?

Halim Ben Haj Salah and François Tardieu\*

Institut National de la Recherche Agronomique, Laboratoire d'Ecophysiologie des Plantes sous Stress Environnementaux, 34060 Montpellier, France

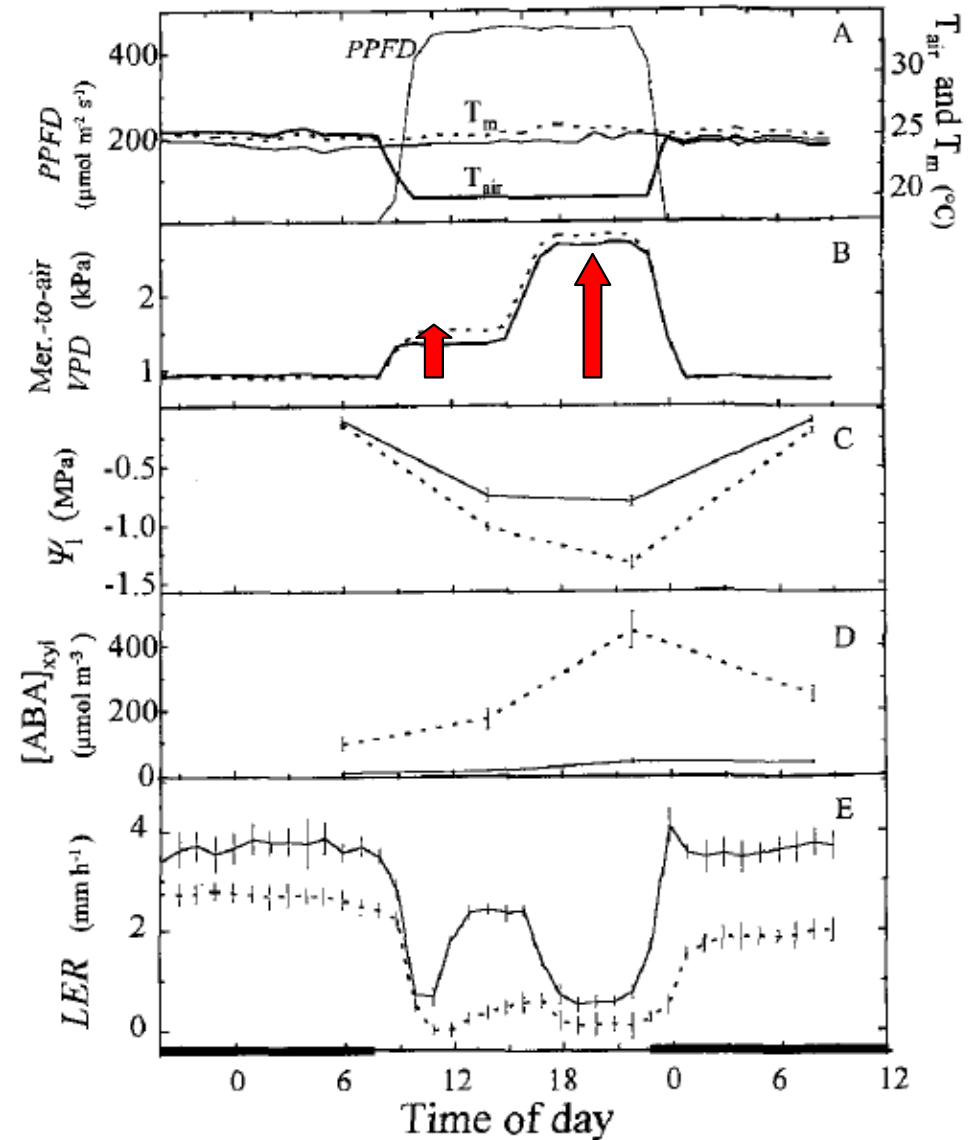

# Hydraulic control of leaf growth

> Growth depressions during the daytime have been attributed to hydraulics in the literature

Plant Physiol. (1997) 114: 893–900

## Control of Leaf Expansion Rate of Droughted Maize Plants under Fluctuating Evaporative Demand<sup>1</sup>

A Superposition of Hydraulic and Chemical Messages?

Halim Ben Haj Salah and François Tardieu\*

Institut National de la Recherche Agronomique, Laboratoire d'Ecophysiologie des Plantes sous Stress Environnementaux, 34060 Montpellier, France

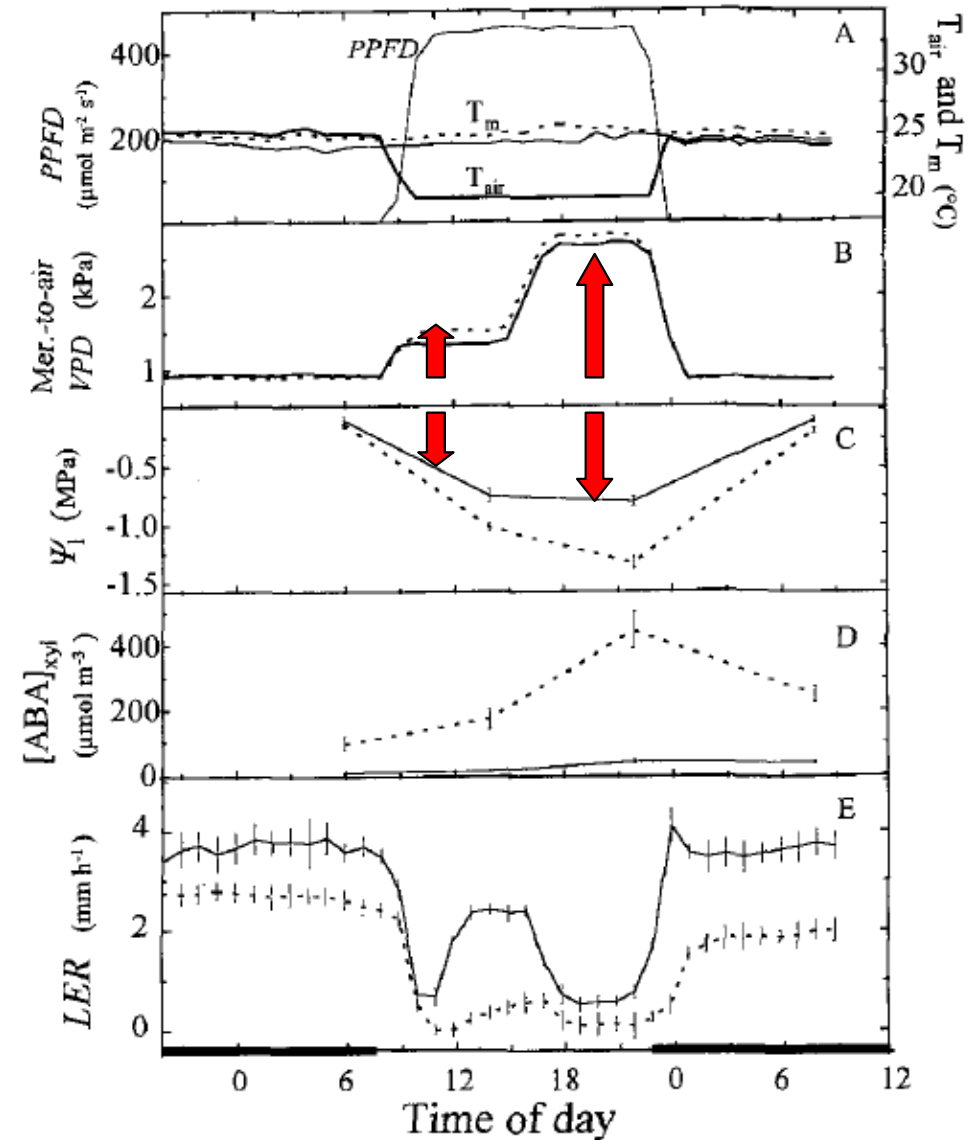

# Hydraulic control of leaf growth

> Growth depressions during the daytime have been attributed to hydraulics in the literature

Plant Physiol. (1997) 114: 893–900

## Control of Leaf Expansion Rate of Droughted Maize Plants under Fluctuating Evaporative Demand<sup>1</sup>

A Superposition of Hydraulic and Chemical Messages?

Halim Ben Haj Salah and François Tardieu\*

Institut National de la Recherche Agronomique, Laboratoire d'Ecophysiologie des Plantes sous Stress Environnementaux, 34060 Montpellier, France

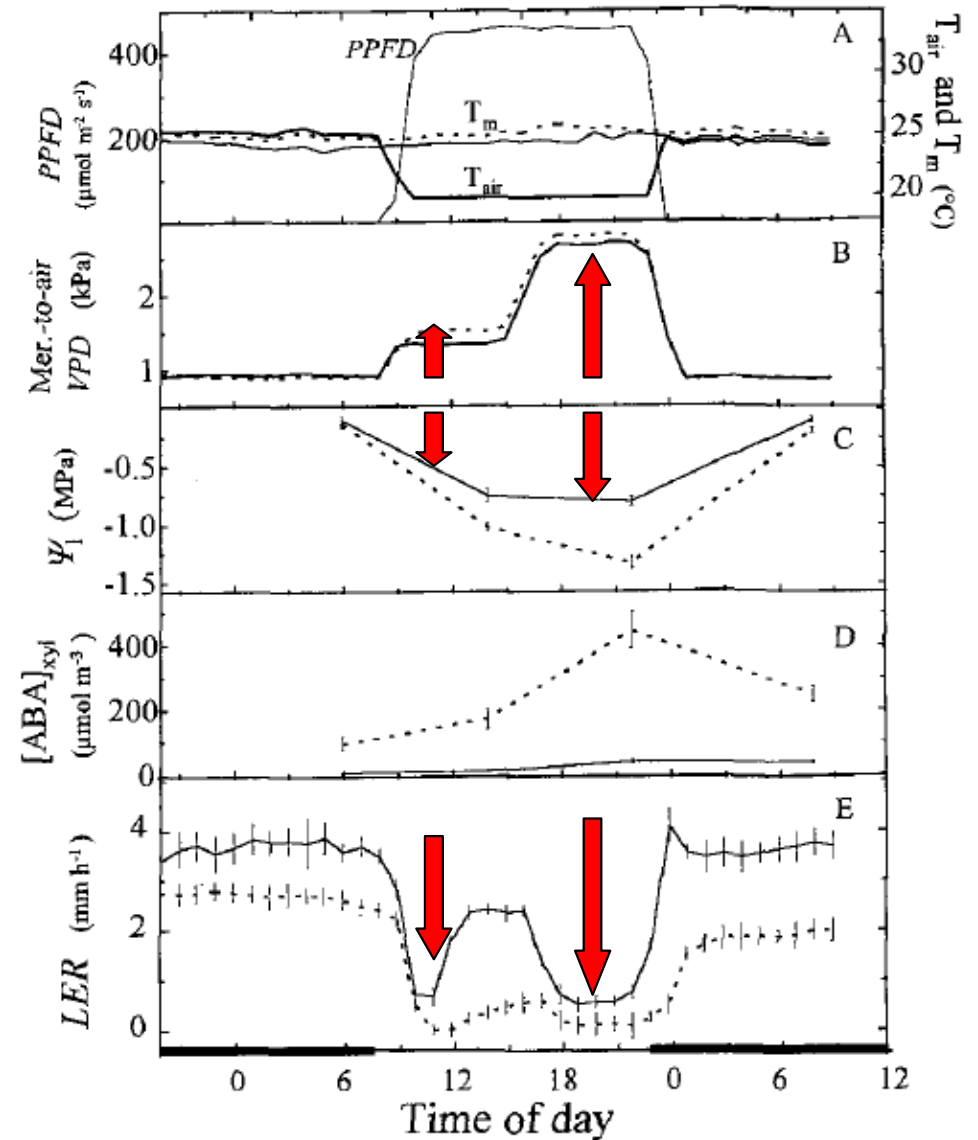

# Hydraulic control of leaf growth

> Using **Relative Expansion Rate** to study leaf growth in *Arabidopsis thaliana*

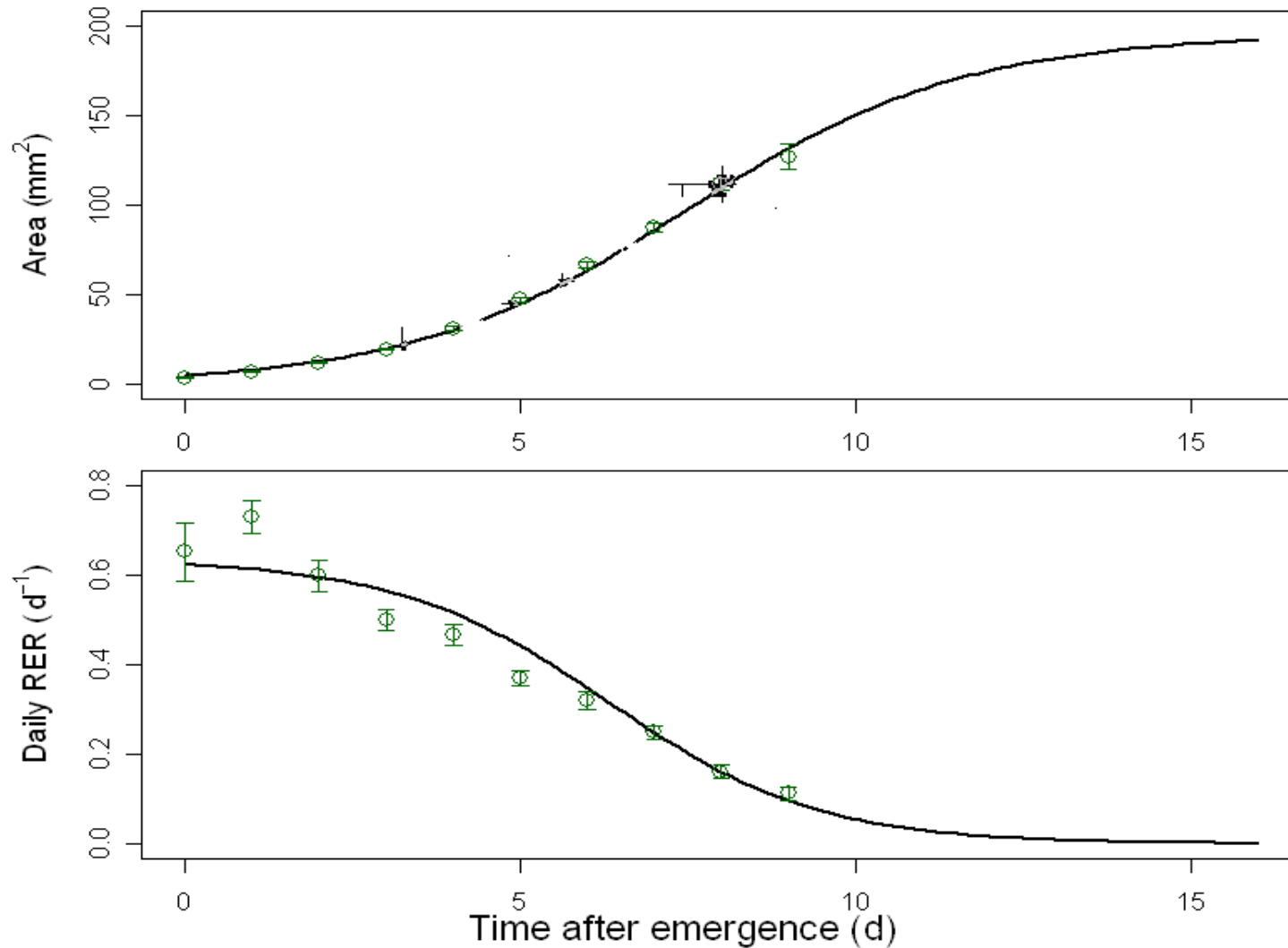



# Hydraulic control of leaf growth

> Using **Relative Expansion Rate** to study leaf growth in *Arabidopsis thaliana*

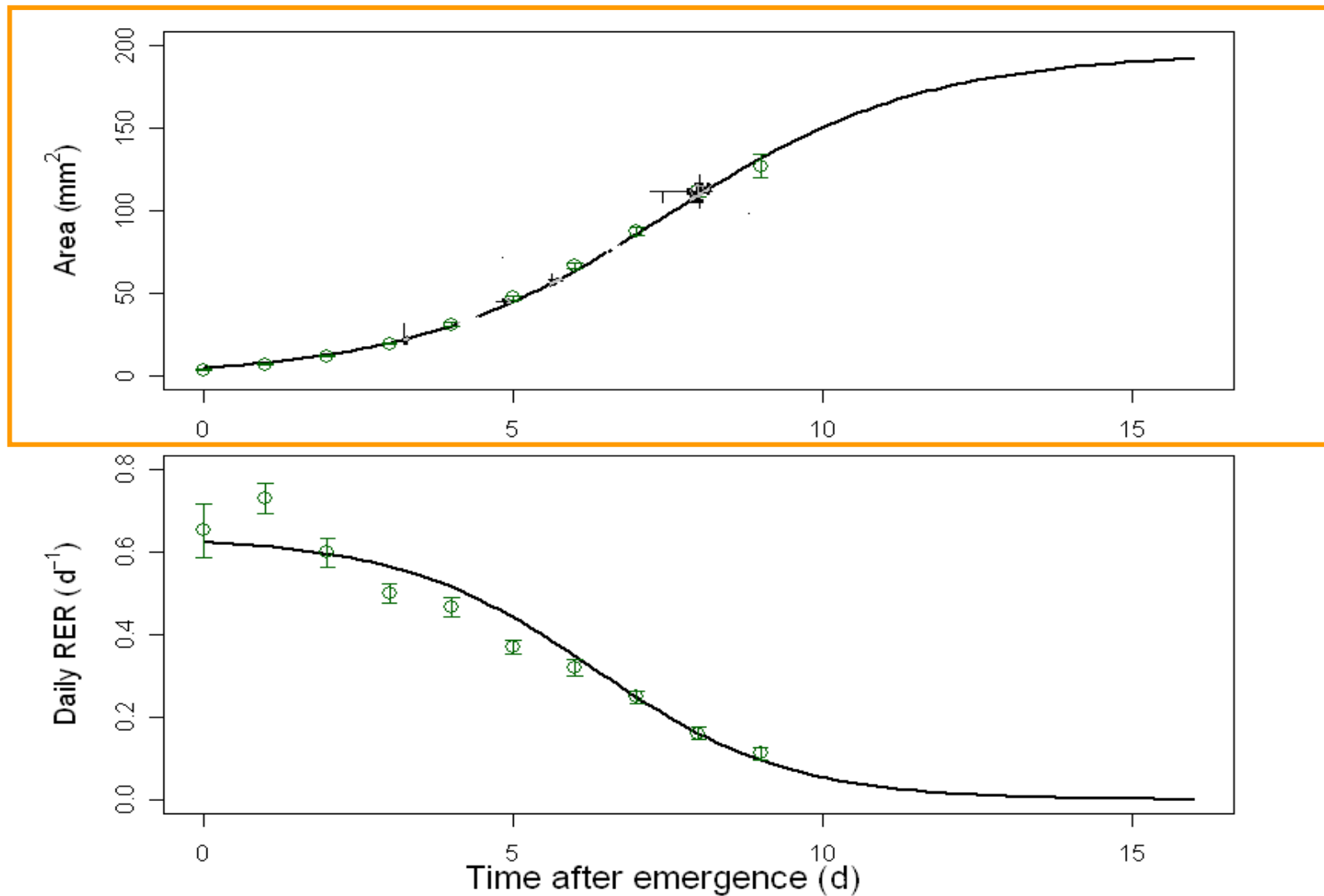

# Hydraulic control of leaf growth

> Using **Relative Expansion Rate** to study leaf growth in *Arabidopsis thaliana*

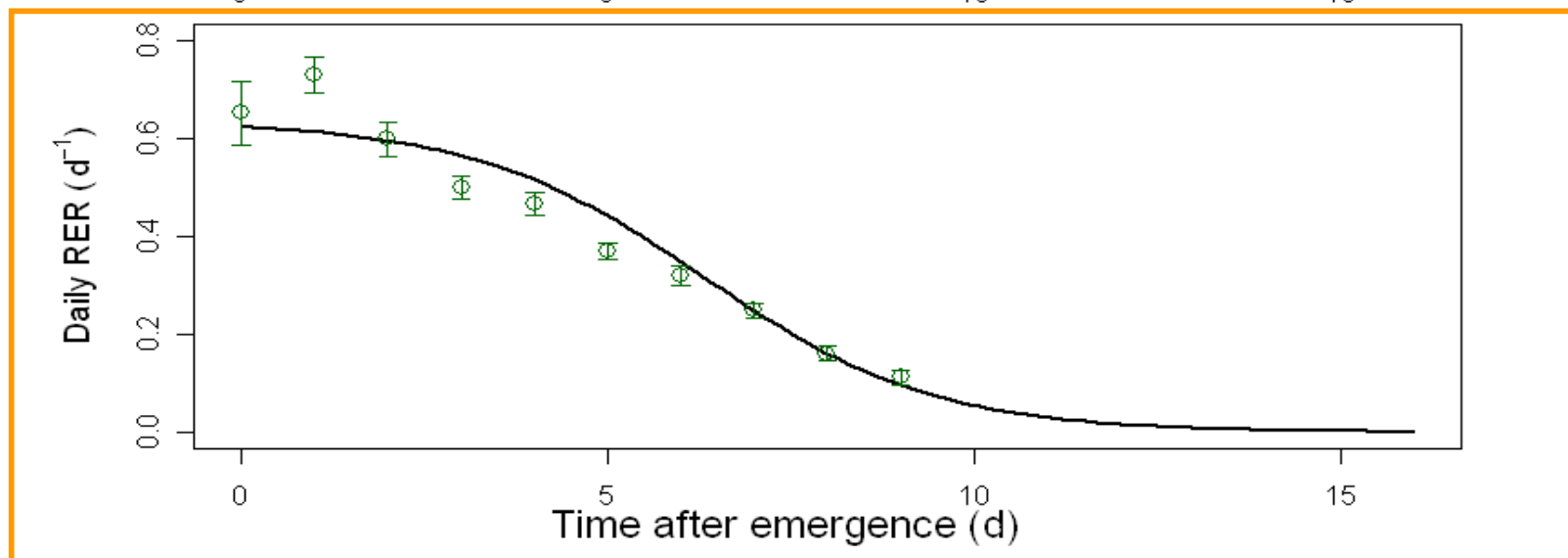
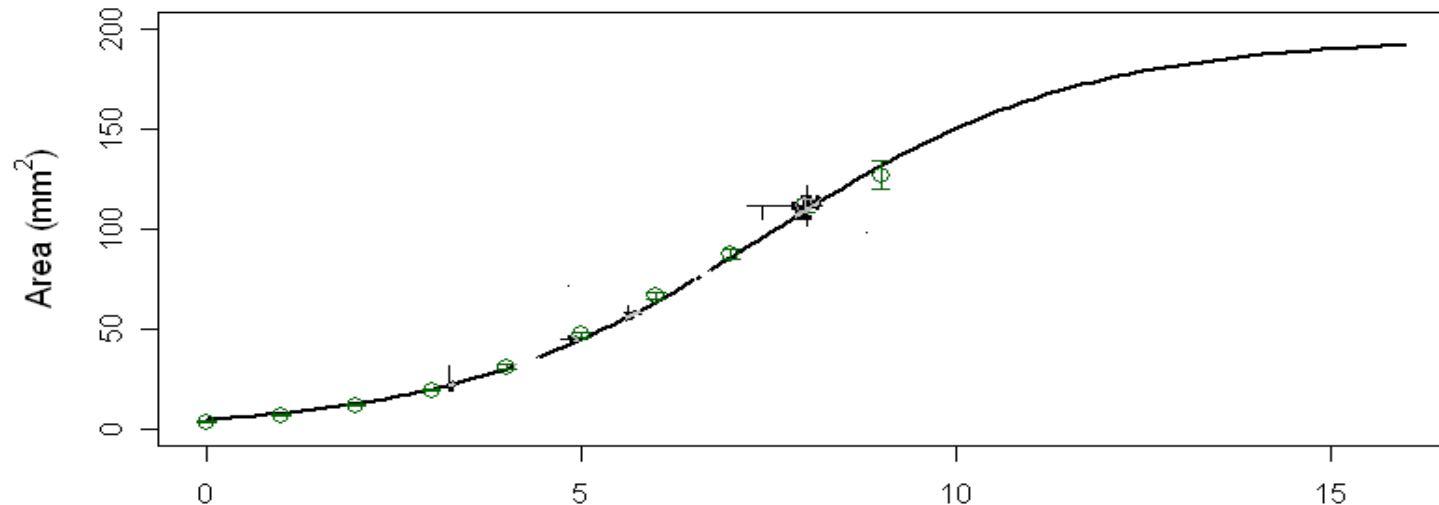

# Hydraulic control of leaf growth

> Using **Relative Expansion Rate** to study leaf growth in *Arabidopsis thaliana*

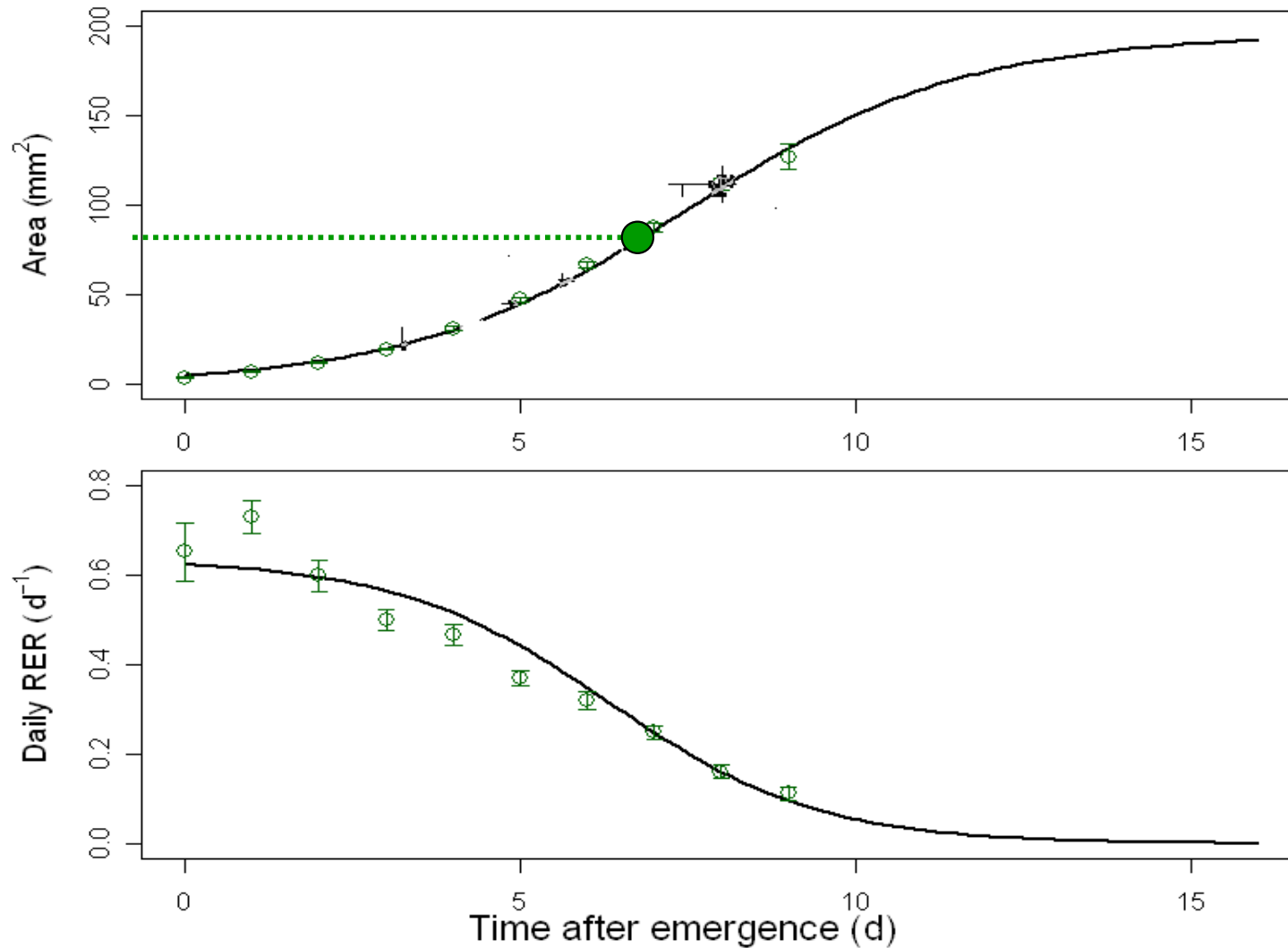

# Hydraulic control of leaf growth

> Using **Relative Expansion Rate** to study leaf growth in *Arabidopsis thaliana*

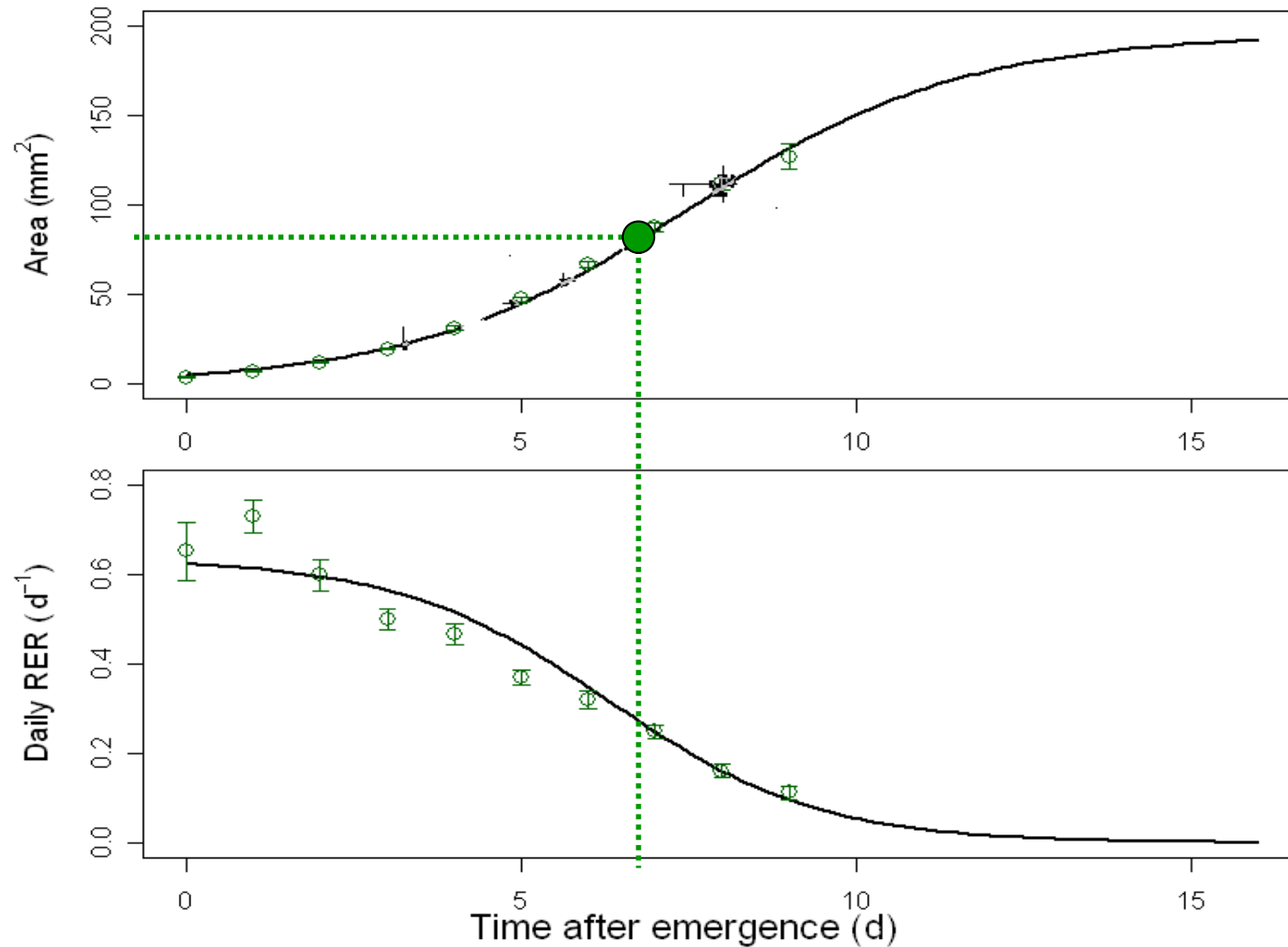

# Hydraulic control of leaf growth

> Using **Relative Expansion Rate** to study leaf growth in *Arabidopsis thaliana*

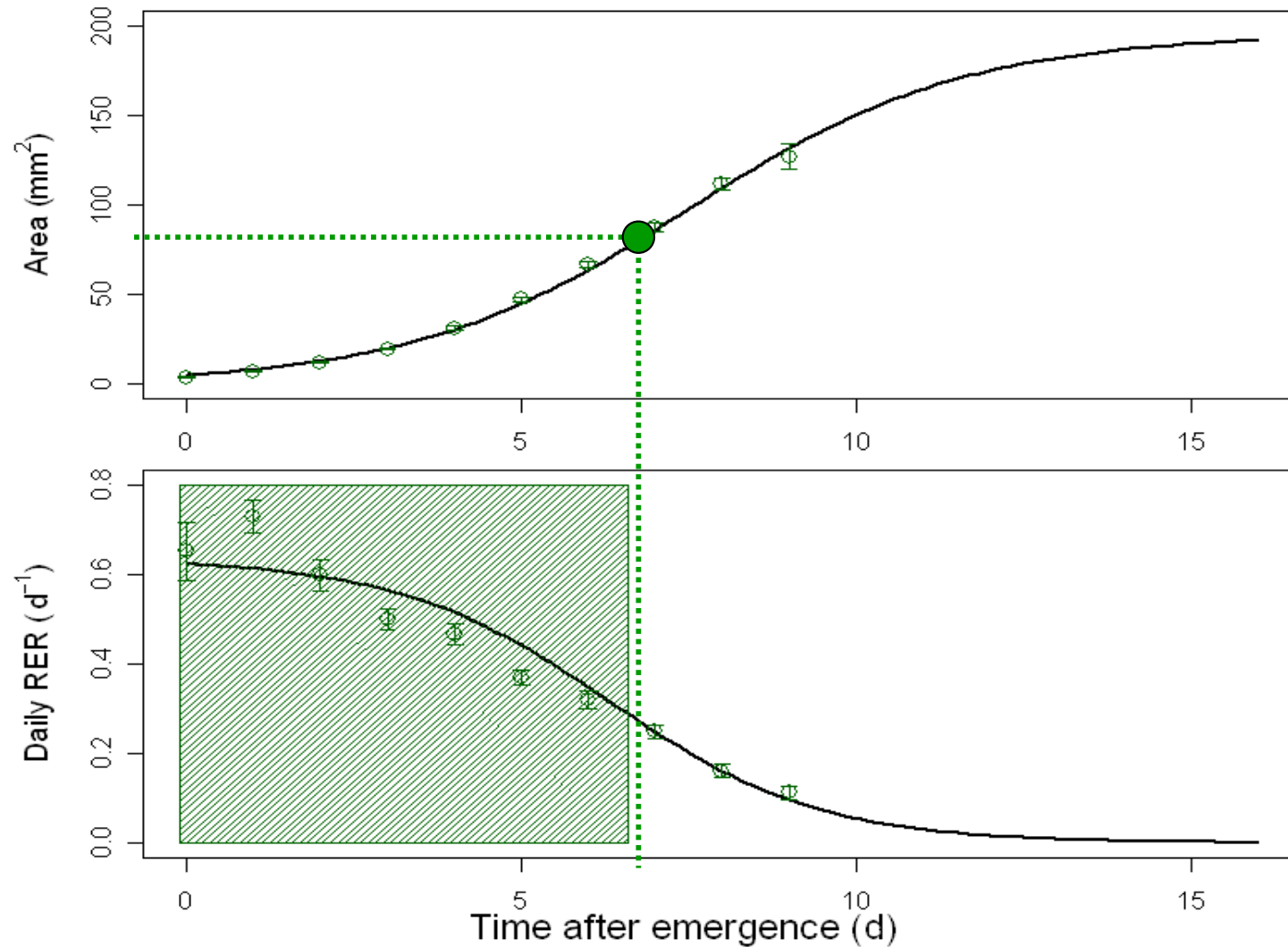

# Hydraulic control of leaf growth

> A day/night analysis of leaf growth reveals **growth depressions in the daytime** which amplify during leaf development

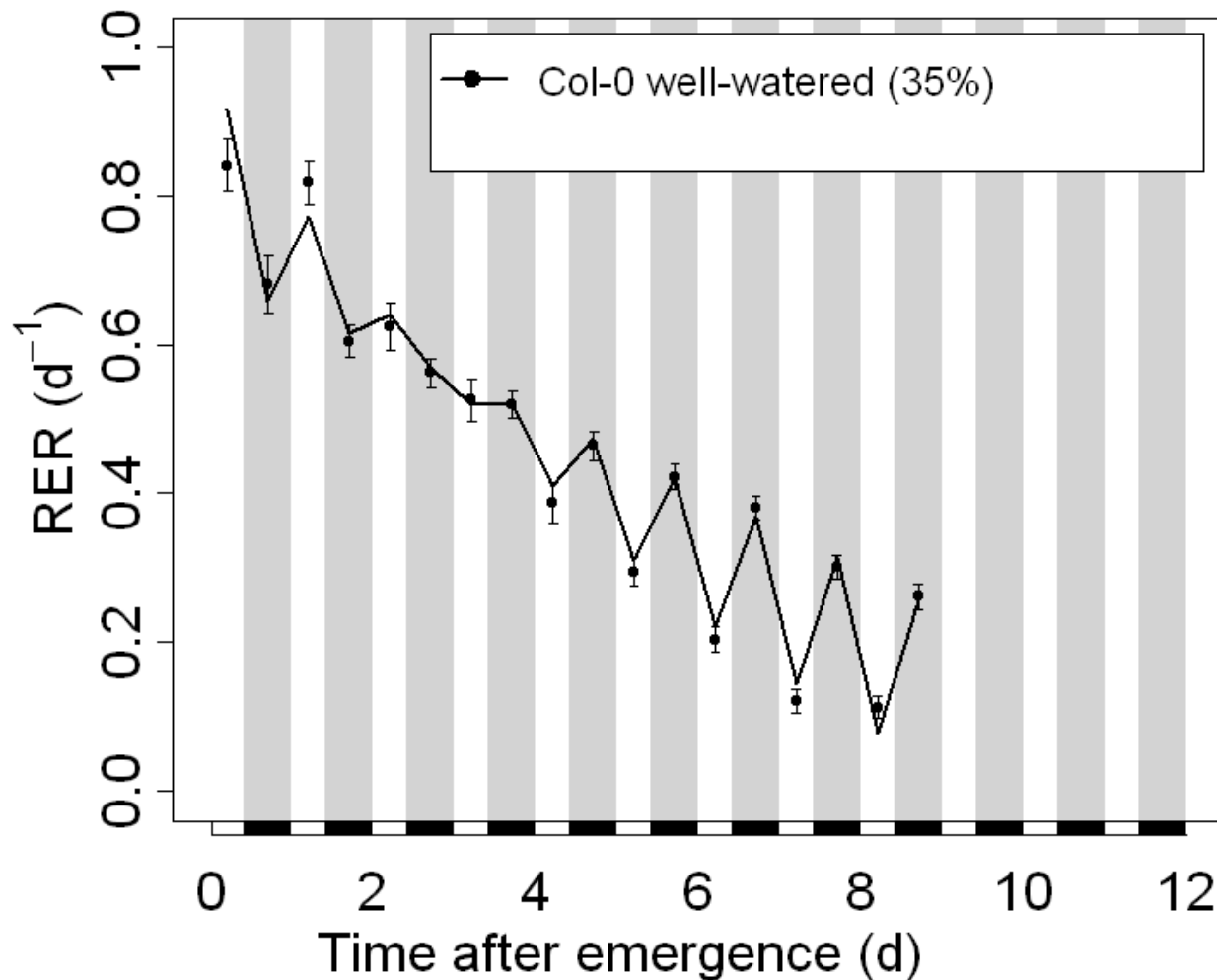

[PANTIN et al., 2011]

# Hydraulic control of leaf growth

> A day/night analysis of leaf growth reveals **growth depressions in the daytime** which amplify during leaf development

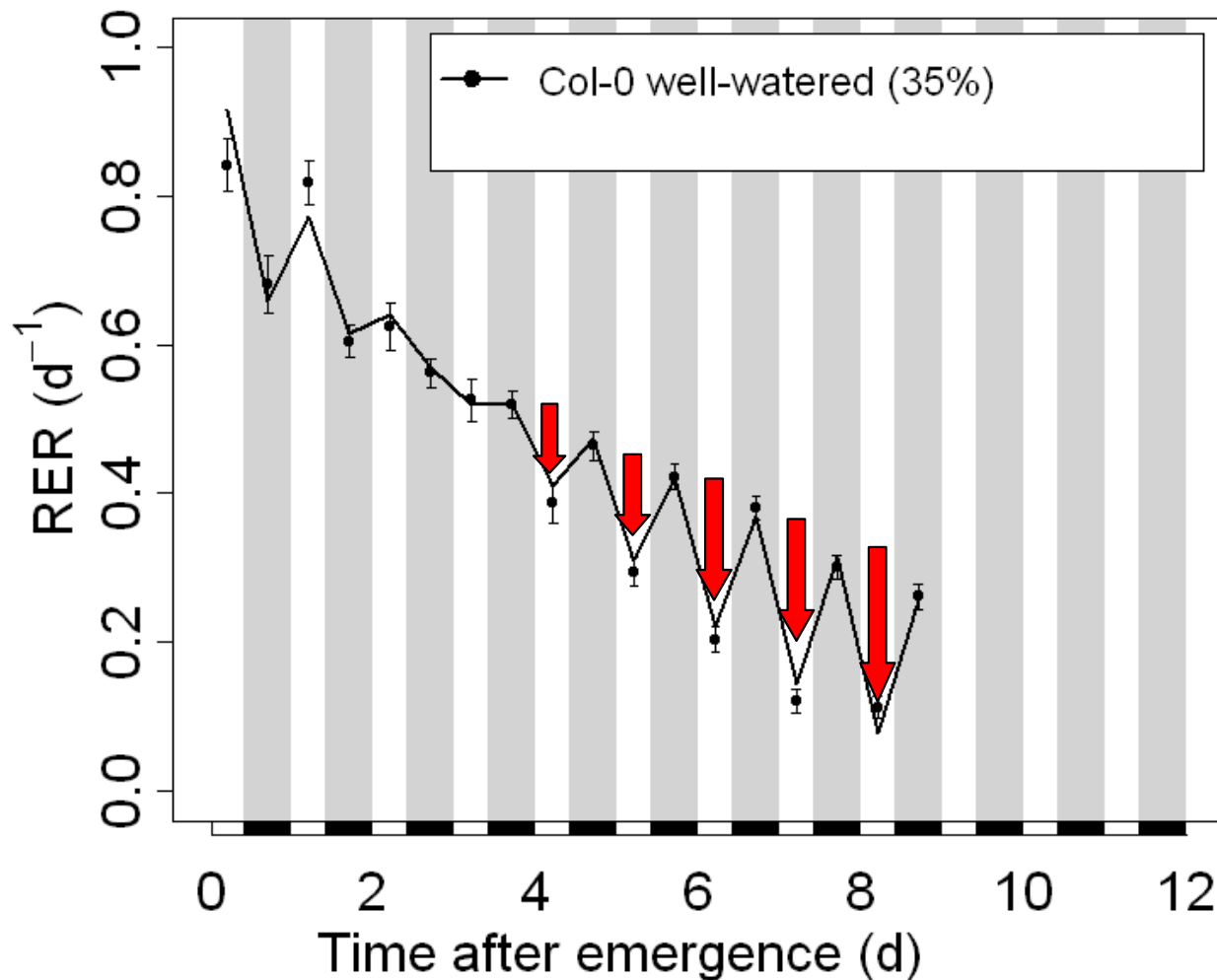

[PANTIN et al., 2011]

# Hydraulic control of leaf growth

> Amplification of these depressions in the **daytime** under soil water deficit suggests their **hydraulic origin**

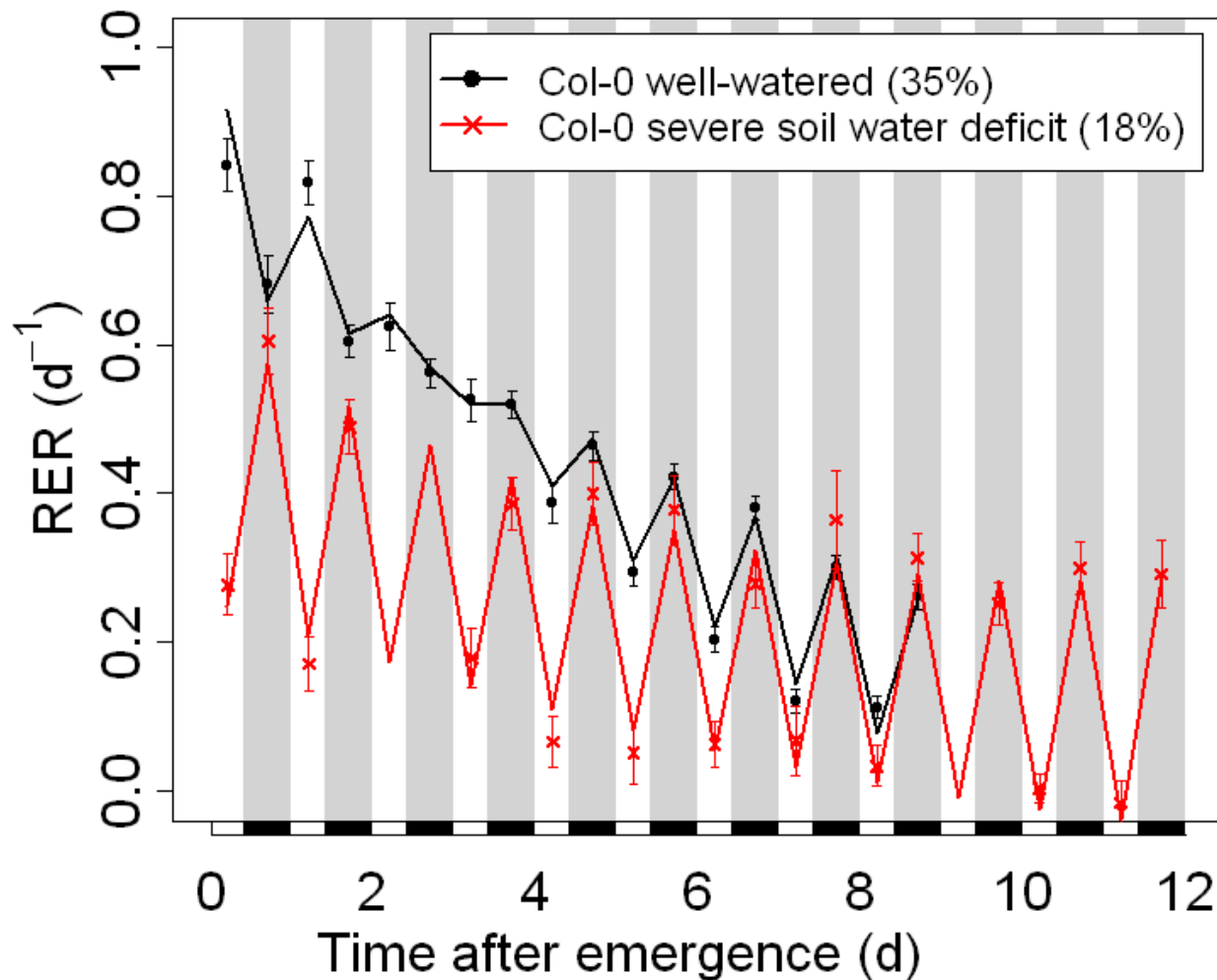

[PANTIN et al., 2011]



# Hydraulic control of leaf growth

> Amplification of these depressions in the **daytime** under soil water deficit suggests their **hydraulic origin**

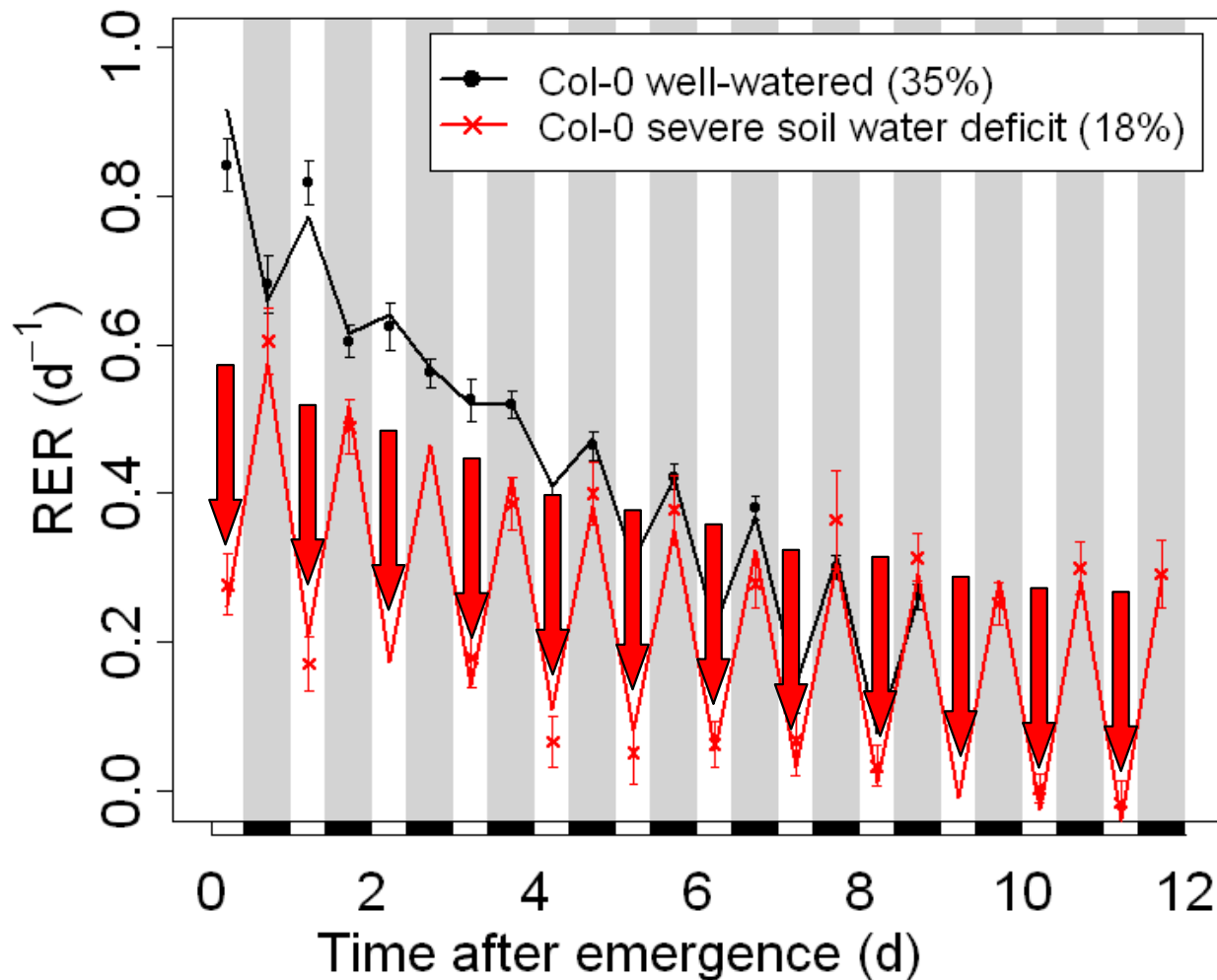

[PANTIN et al., 2011]

# Metabolic control of leaf growth

> Amplification of **early** depressions in the **nighttime** in starch mutants suggests their **metabolic origin**

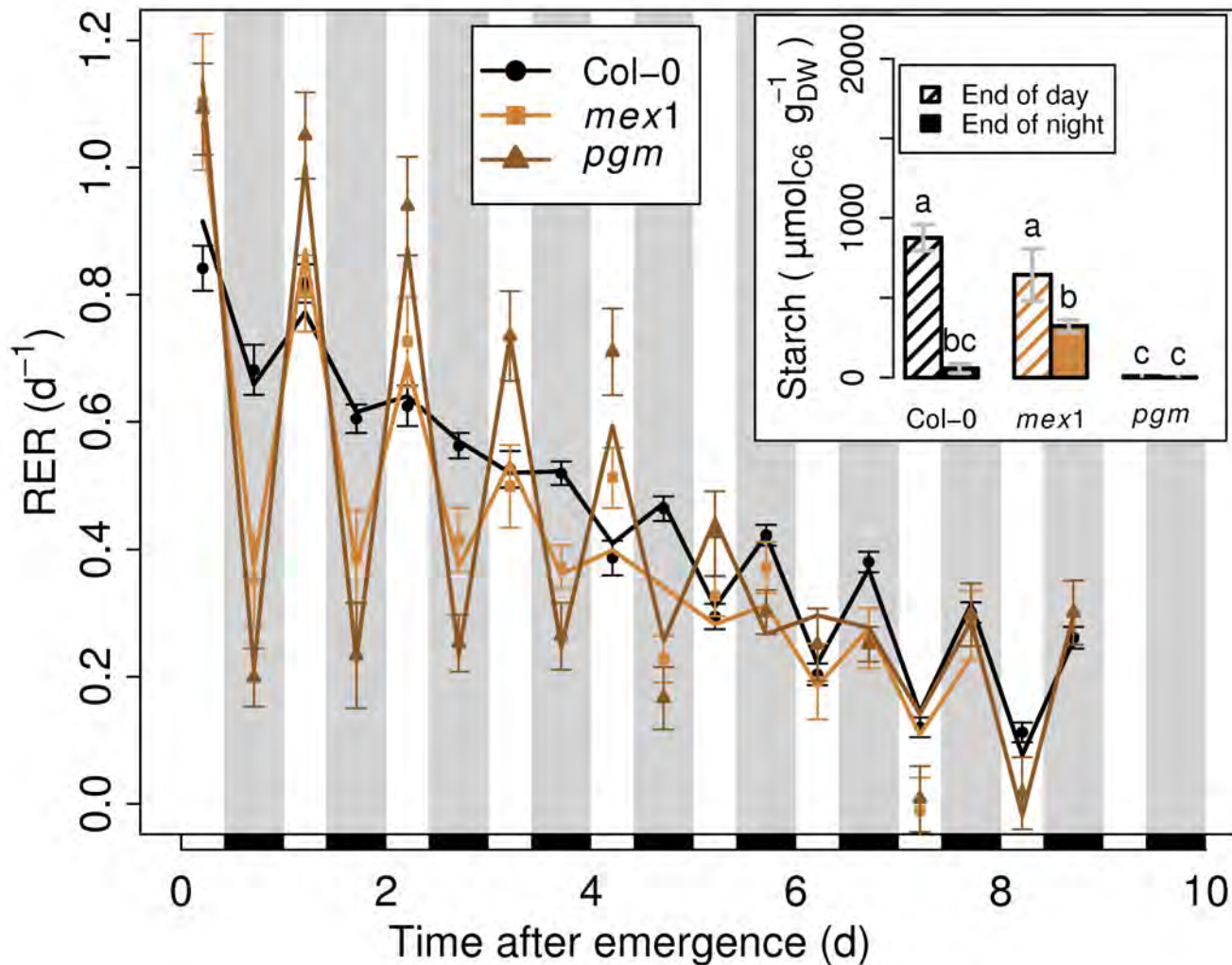

[PANTIN et al., 2011]

# Hydraulic control of leaf growth

> Using a set of mutants grown under several environments, it was concluded that during the course of its ontogeny, **the predominant control of leaf expansion switches from metabolics to hydraulics**

**Metabolic** control



**Hydraulic** control

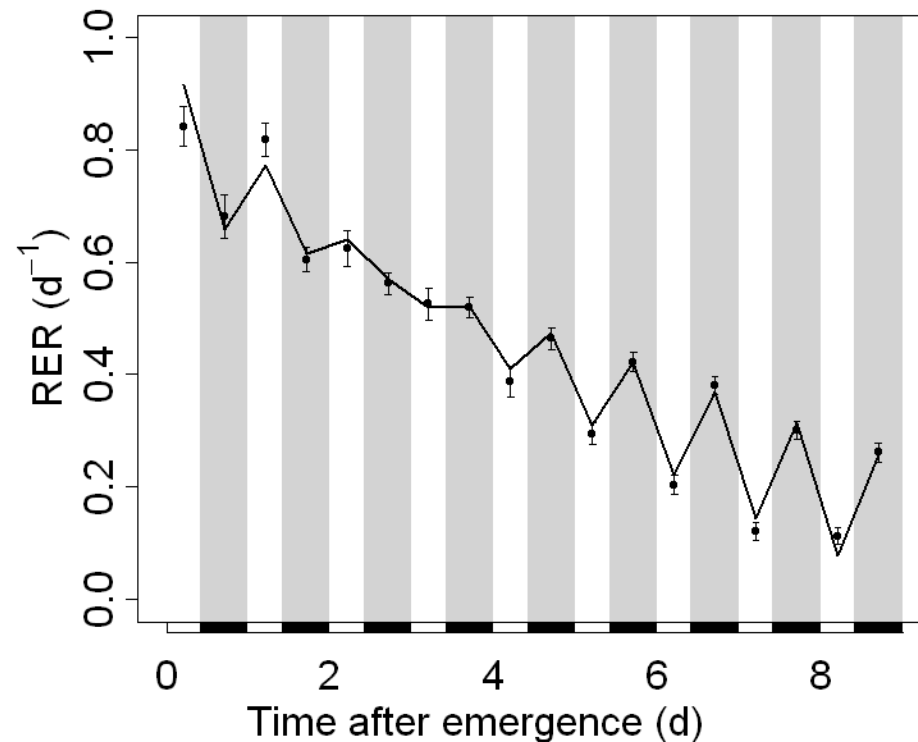

[PANTIN et al., 2011]

# Leaf growth: establishment of hydraulic control

## > AIMS:

- check the **hydraulic nature** of diurnal depressions
- understand **what underlies the establishment** of water predominance in the control of leaf growth

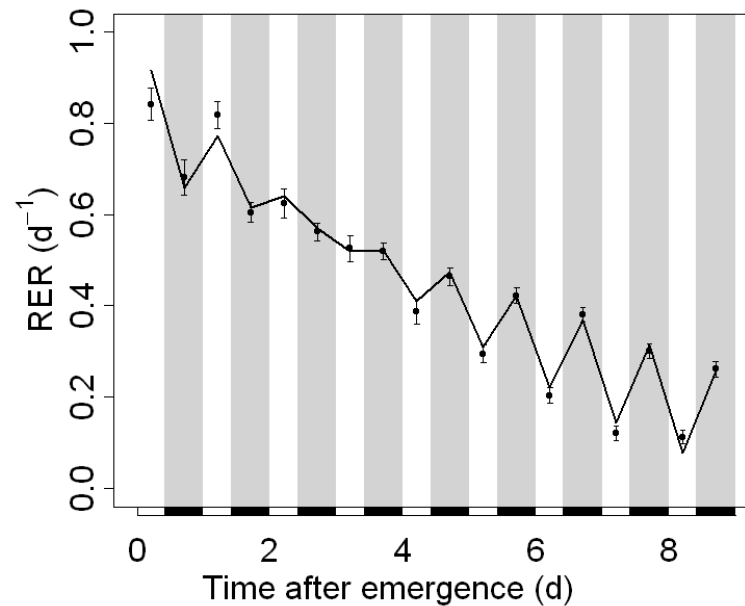



## Leaf growth: establishment of hydraulic control

– I –

Emergence of diurnal hydraulic limitations:  
evidence from day/night water potentials  
and transpiration

# Leaf growth: establishment of hydraulic control

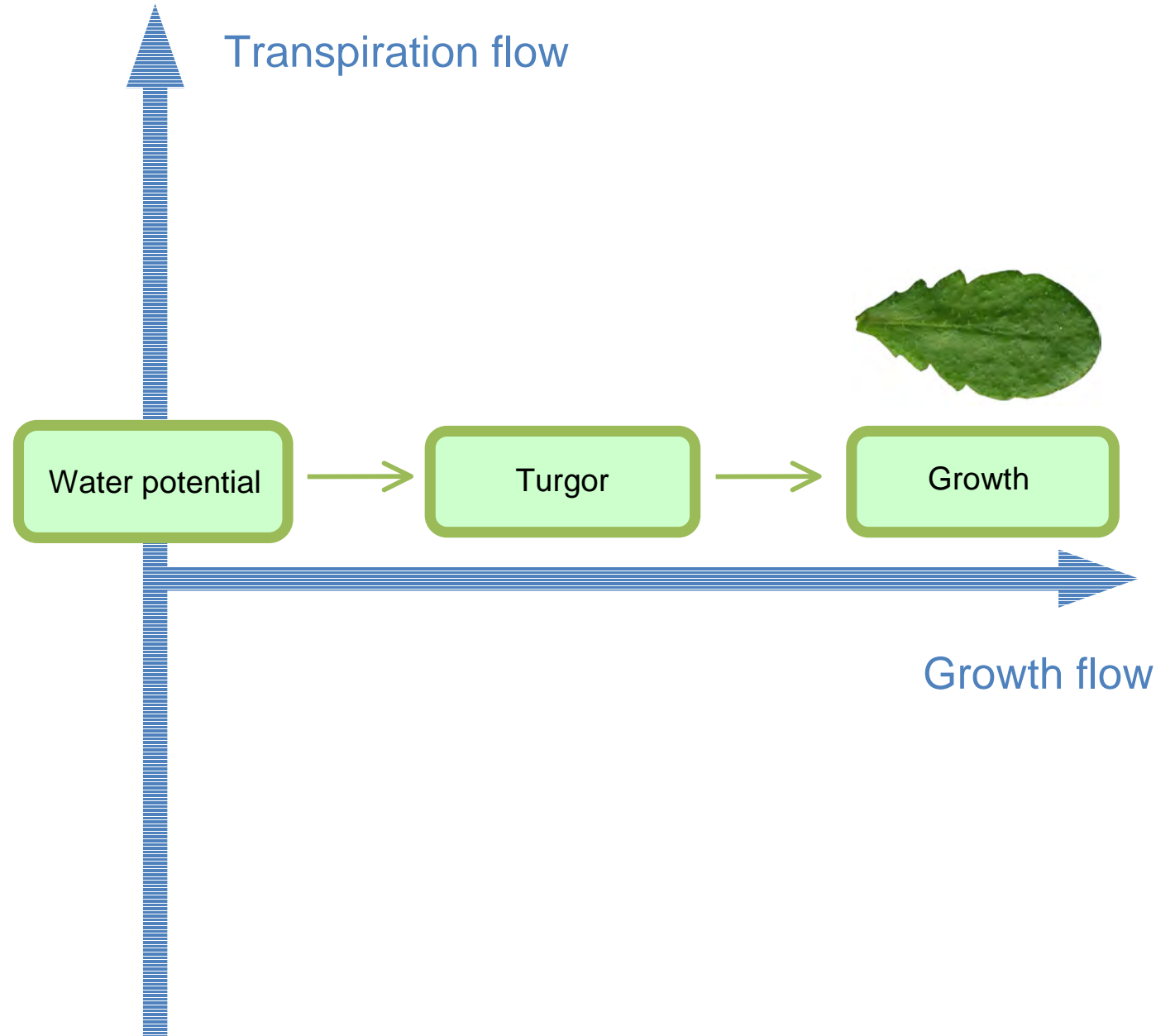

# Leaf growth: establishment of hydraulic control

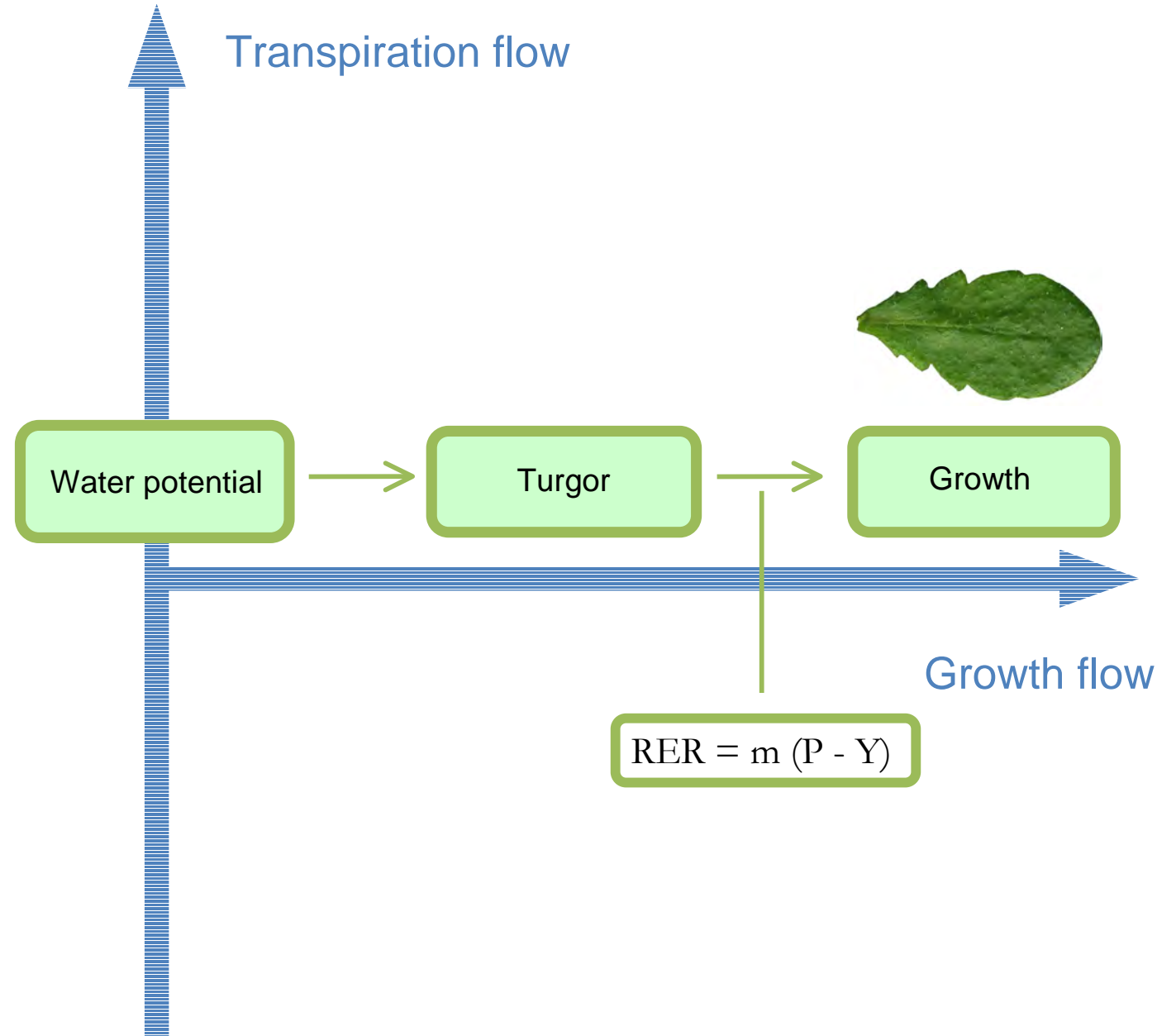

# Leaf growth: establishment of hydraulic control

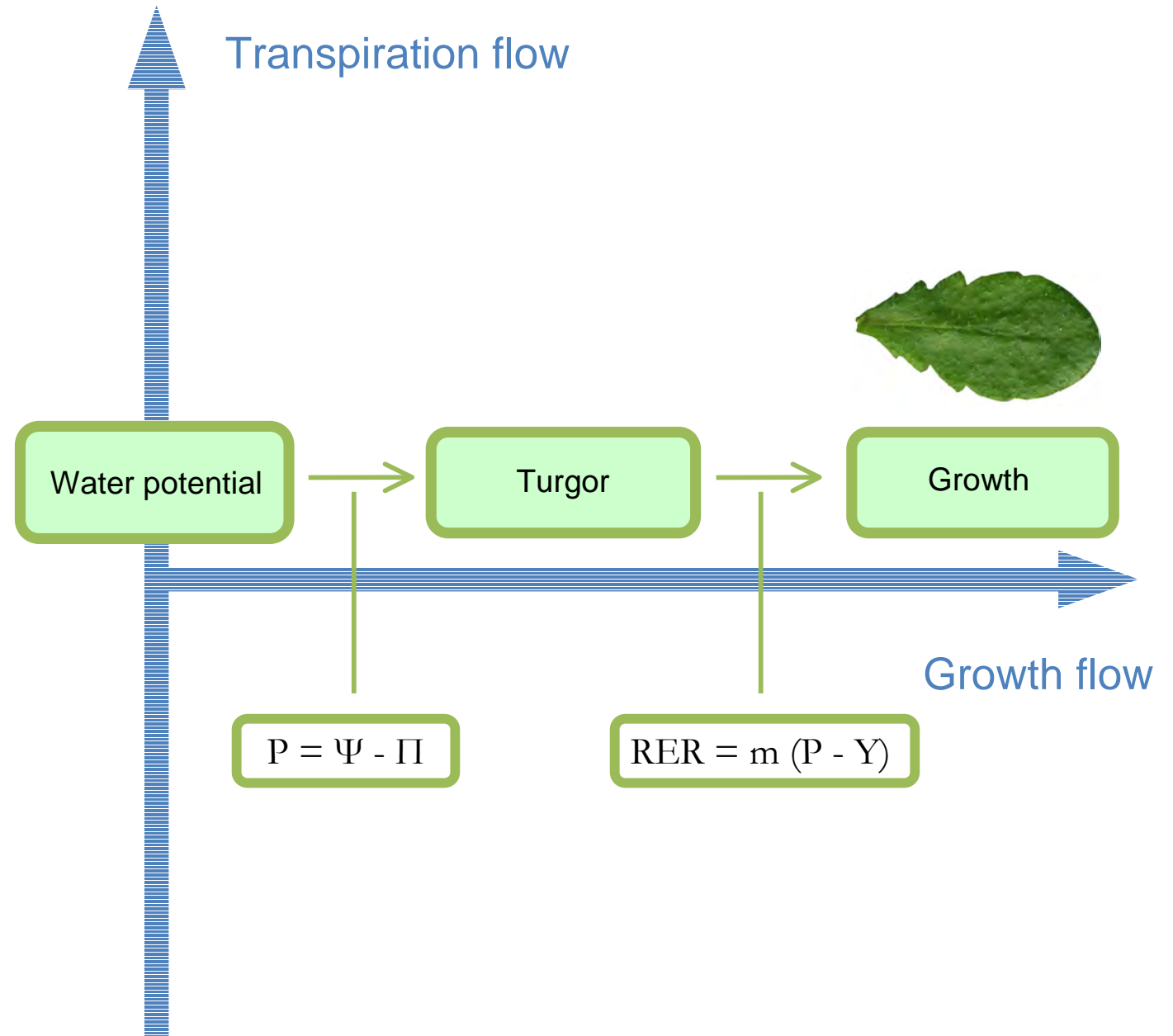



# Leaf growth: establishment of hydraulic control

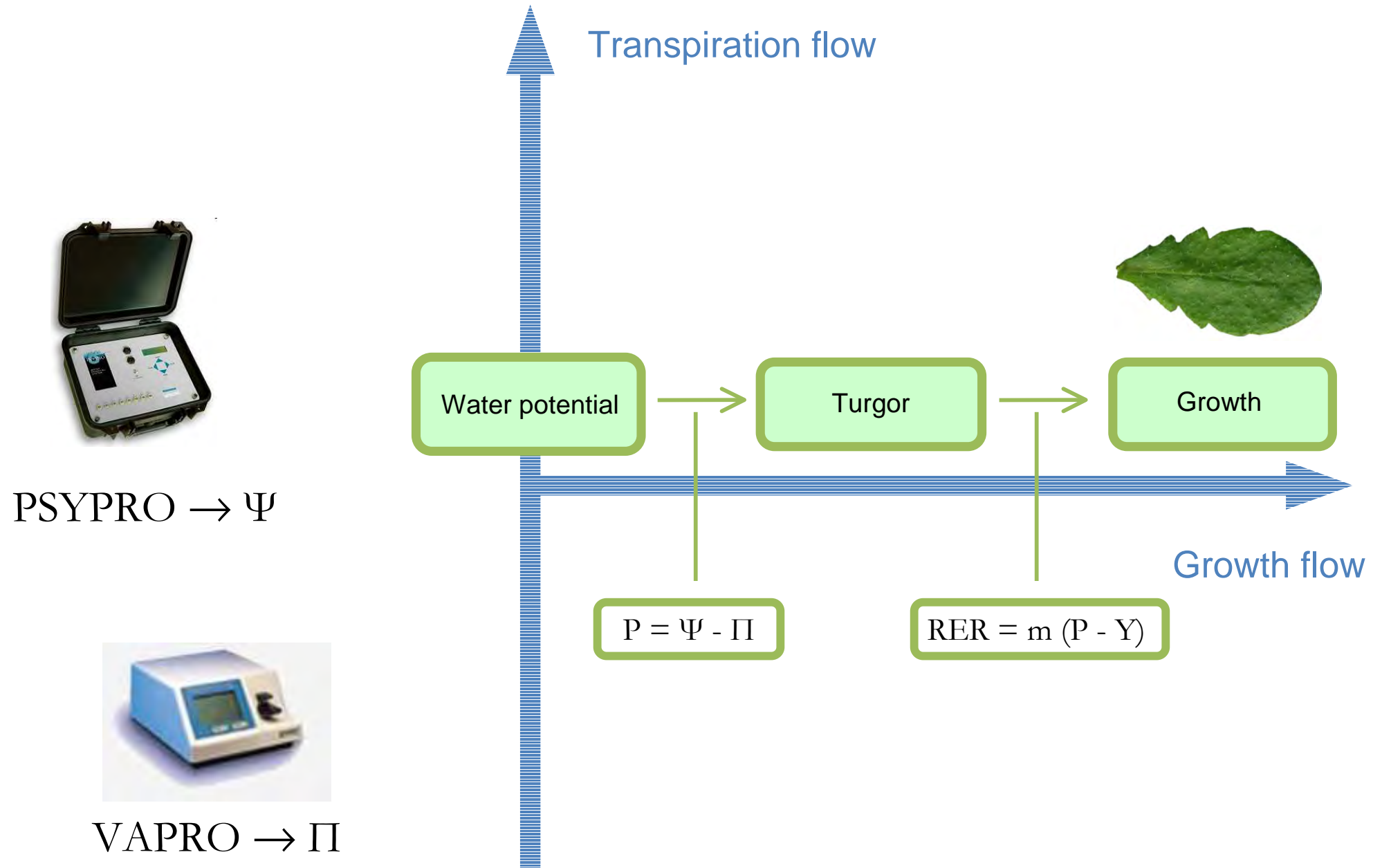

# Leaf water status

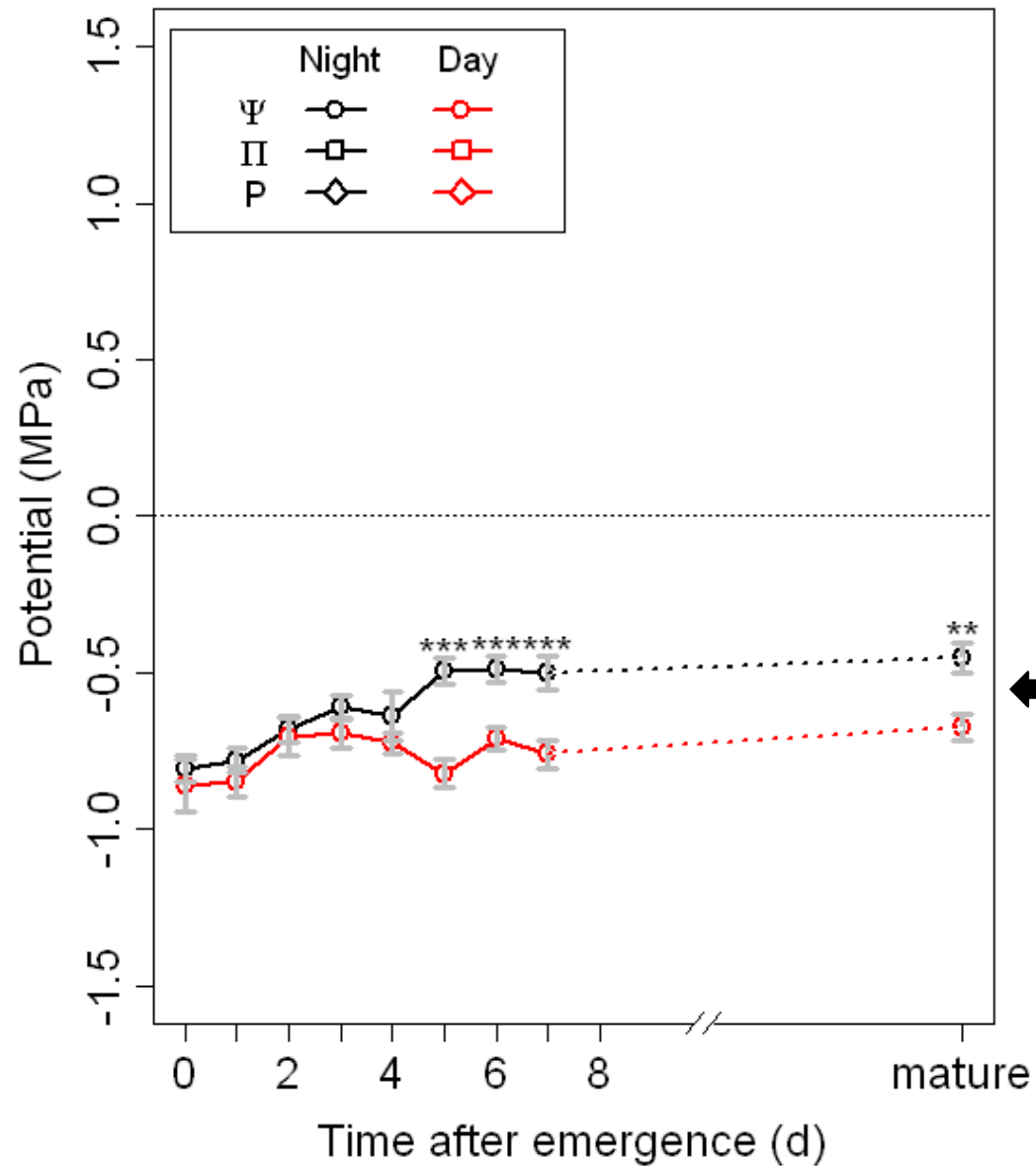

> Water potential  $\Psi$  increases with leaf development

> **Differences between day and night** progressively emerge

←  $\Psi$

# Leaf water status

*Journal of Experimental Botany*, Vol. 53, No. 368, pp. 489–503, March 2002



## Growth-induced water potentials and the growth of maize leaves

An-Ching Tang and John S. Boyer<sup>1</sup>

*College of Marine Studies and College of Agriculture and Natural Resources, University of Delaware, Lewes, DE 19958, USA*

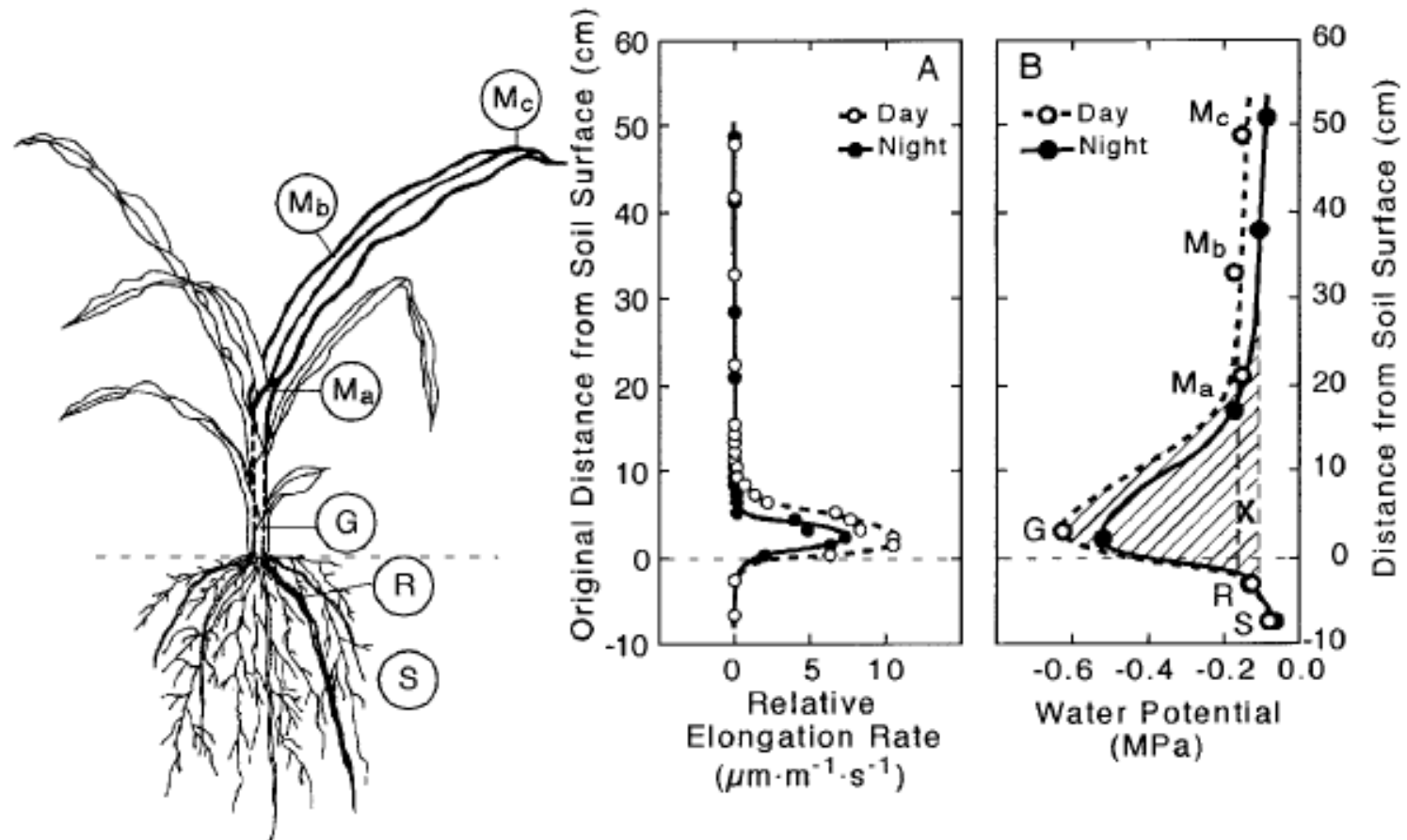

# Leaf water status

*Journal of Experimental Botany*, Vol. 53, No. 368, pp. 489–503, March 2002



## Growth-induced water potentials and the growth of maize leaves

An-Ching Tang and John S. Boyer<sup>1</sup>

*College of Marine Studies and College of Agriculture and Natural Resources, University of Delaware, Lewes, DE 19958, USA*

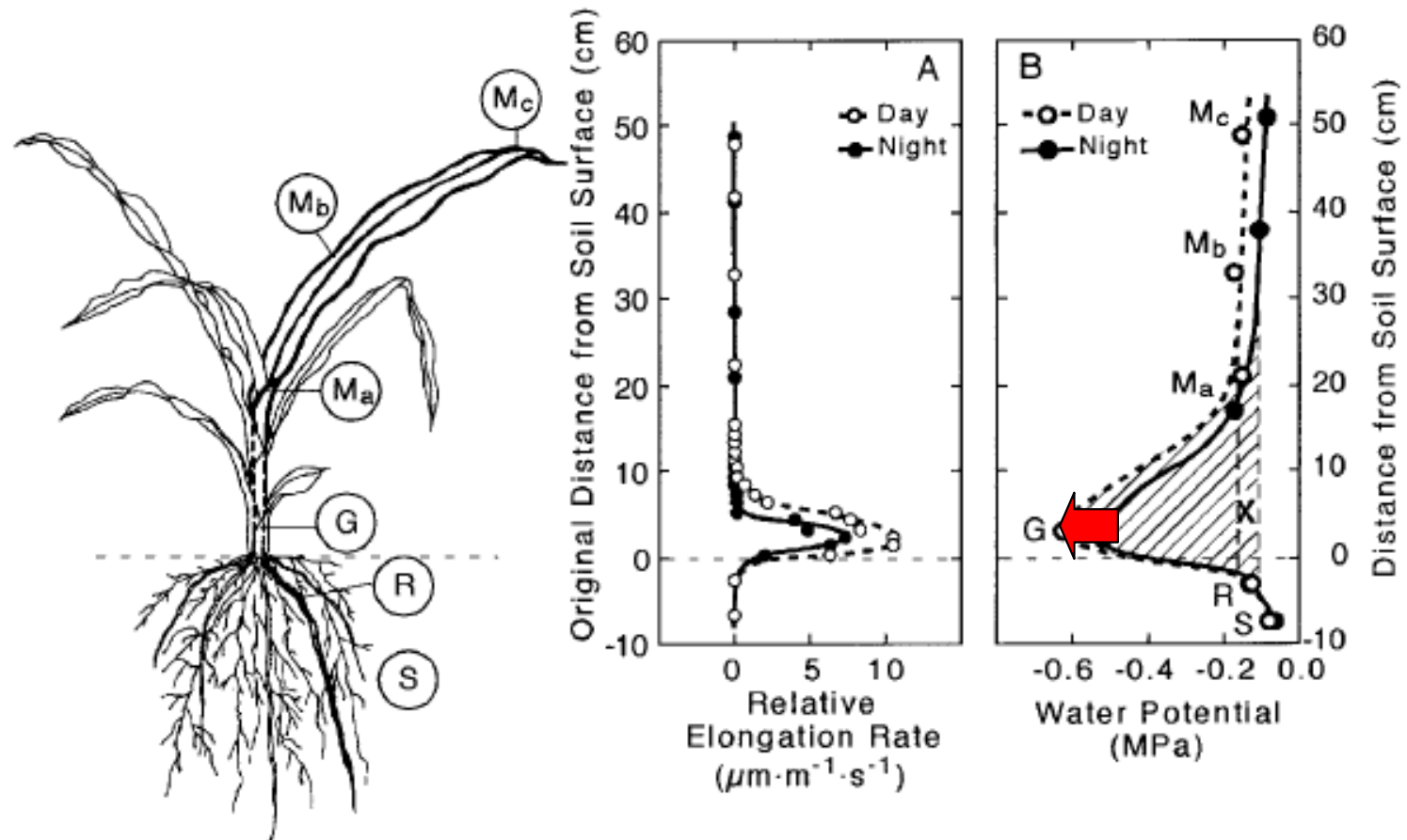

# Leaf water status

Journal of Experimental Botany, Vol. 53, No. 368, pp. 489-503, March 2002



## Growth-induced water potentials and the growth of maize leaves

An-Ching Tang and John S. Boyer<sup>1</sup>

College of Marine Studies and College of Agriculture and Natural Resources, University of Delaware, Lewes, DE 19958, USA

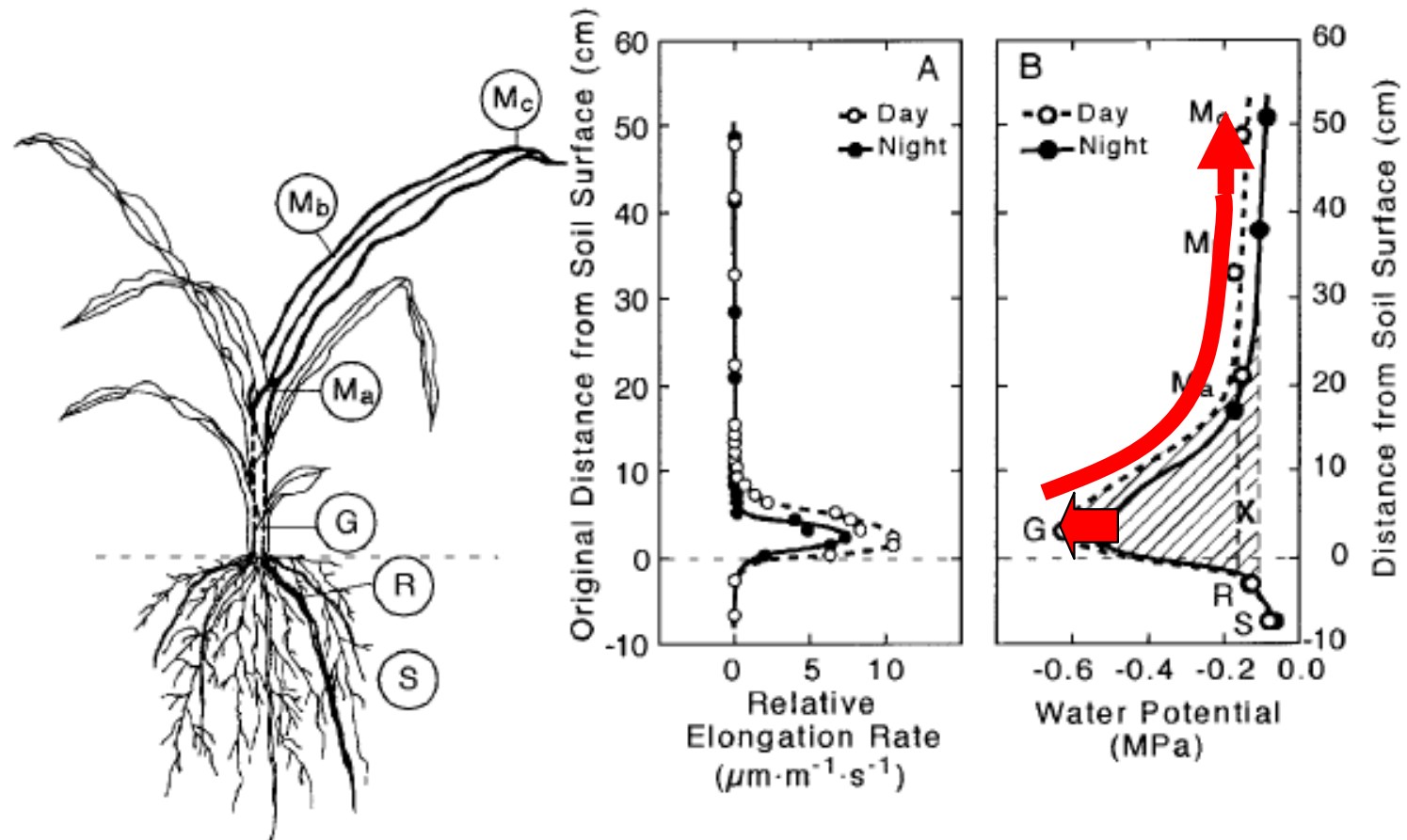

# Leaf water status

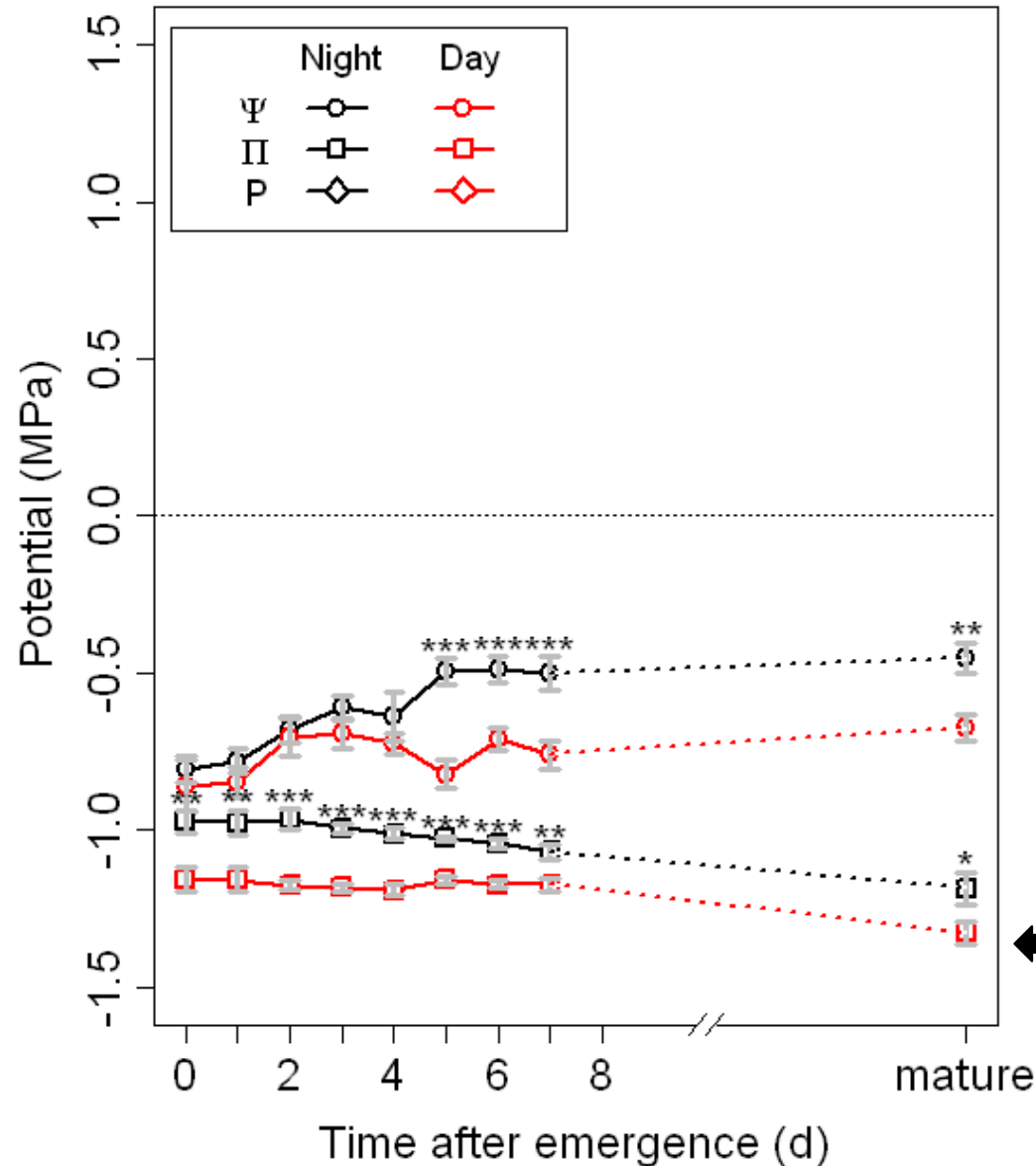

> Osmotic potential  $\Pi$  is nearly stable

> **Diurnal  $\Pi$**  is lower than **nocturnal  $\Pi$**  because solutes accumulate (i) actively with sugar and organic acids biosynthesis and (ii) passively with water loss due to transpiration

←  $\Pi$

# Leaf water status

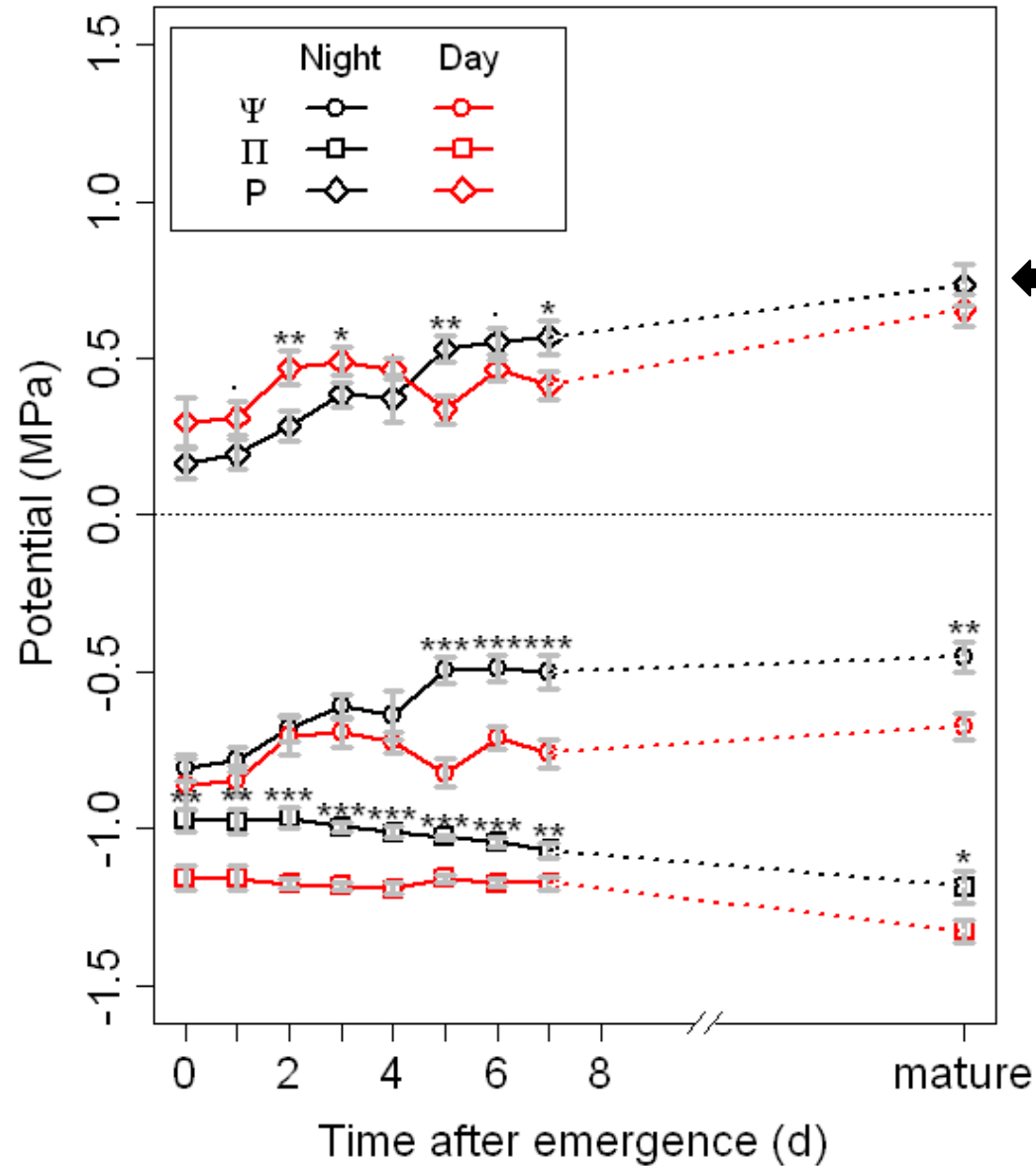

**P**

> Day/night differences in turgor **P** reverse during the course of leaf development

> Diurnal depressions of **P** are consistent with the diurnal depressions of growth

# Leaf water status

Plant, Cell and Environment (2006) 29, 1138–1148

doi: 10.1111/j.1365-3040.2005.01494.x

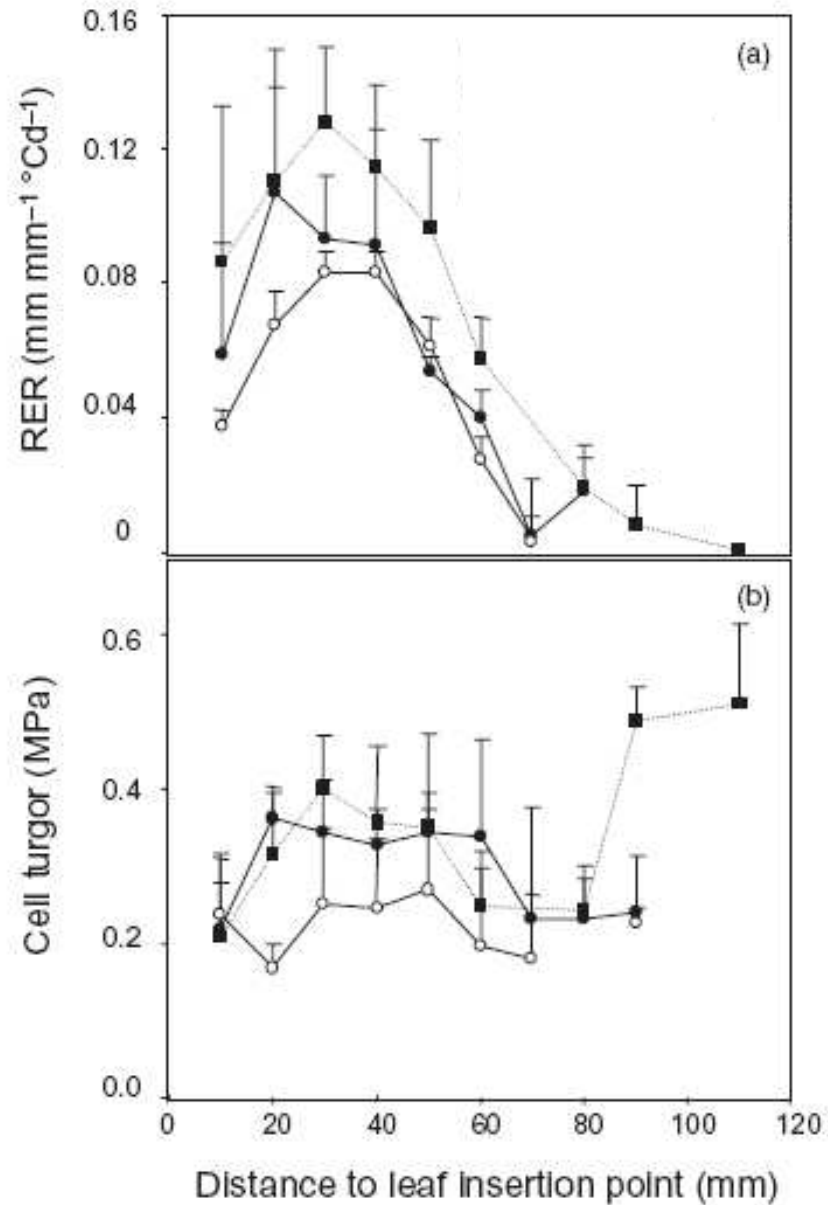

**Leaf growth and turgor in growing cells of maize (*Zea mays* L.) respond to evaporative demand under moderate irrigation but not in water-saturated soil**

OUMAYA BOUCHABKÉ, FRANÇOIS TARDIEU & THIERRY SIMONNEAU

Laboratoire d'Ecophysiologie des Plantes sous Stress Environnementaux, UMR Institut National de la Recherche Agronomique, École Nationale Supérieure d'Agronomie de Montpellier, F- 34060 Montpellier cedex 1, France

- Night
- Day – low VPD
- Day – high VPD



# Leaf water status

Plant, Cell and Environment (2006) 29, 1138–1148

doi: 10.1111/j.1365-3040.2005.01494.x

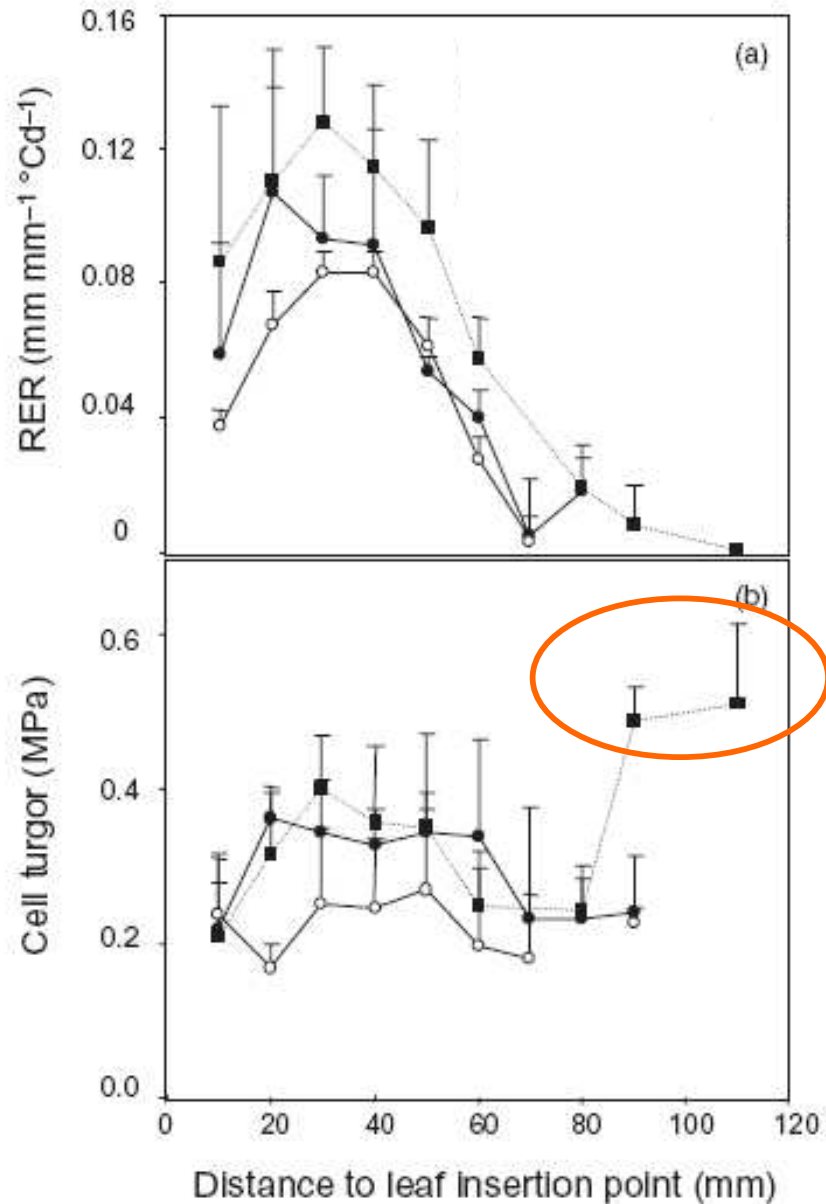

**Leaf growth and turgor in growing cells of maize (*Zea mays* L.) respond to evaporative demand under moderate irrigation but not in water-saturated soil**

OUMAYA BOUCHABKÉ, FRANÇOIS TARDIEU & THIERRY SIMONNEAU

Laboratoire d'Ecophysiologie des Plantes sous Stress Environnementaux, UMR Institut National de la Recherche Agronomique, École Nationale Supérieure d'Agronomie de Montpellier, F- 34060 Montpellier cedex 1, France

Decrease in wall extensibility?

- Night
- Day – low VPD
- Day – high VPD

# Leaf growth: establishment of hydraulic control

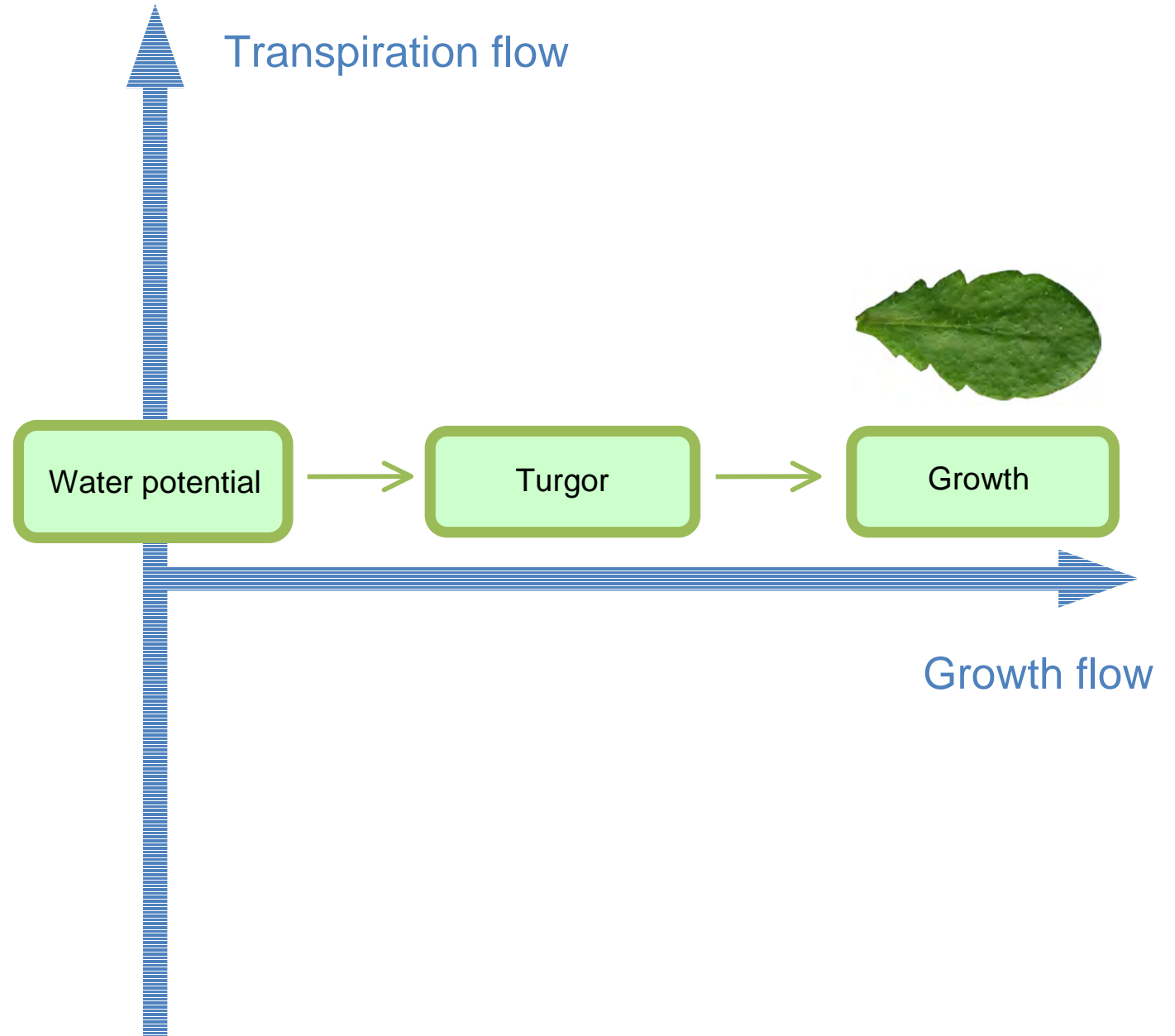

# Leaf growth: establishment of hydraulic control

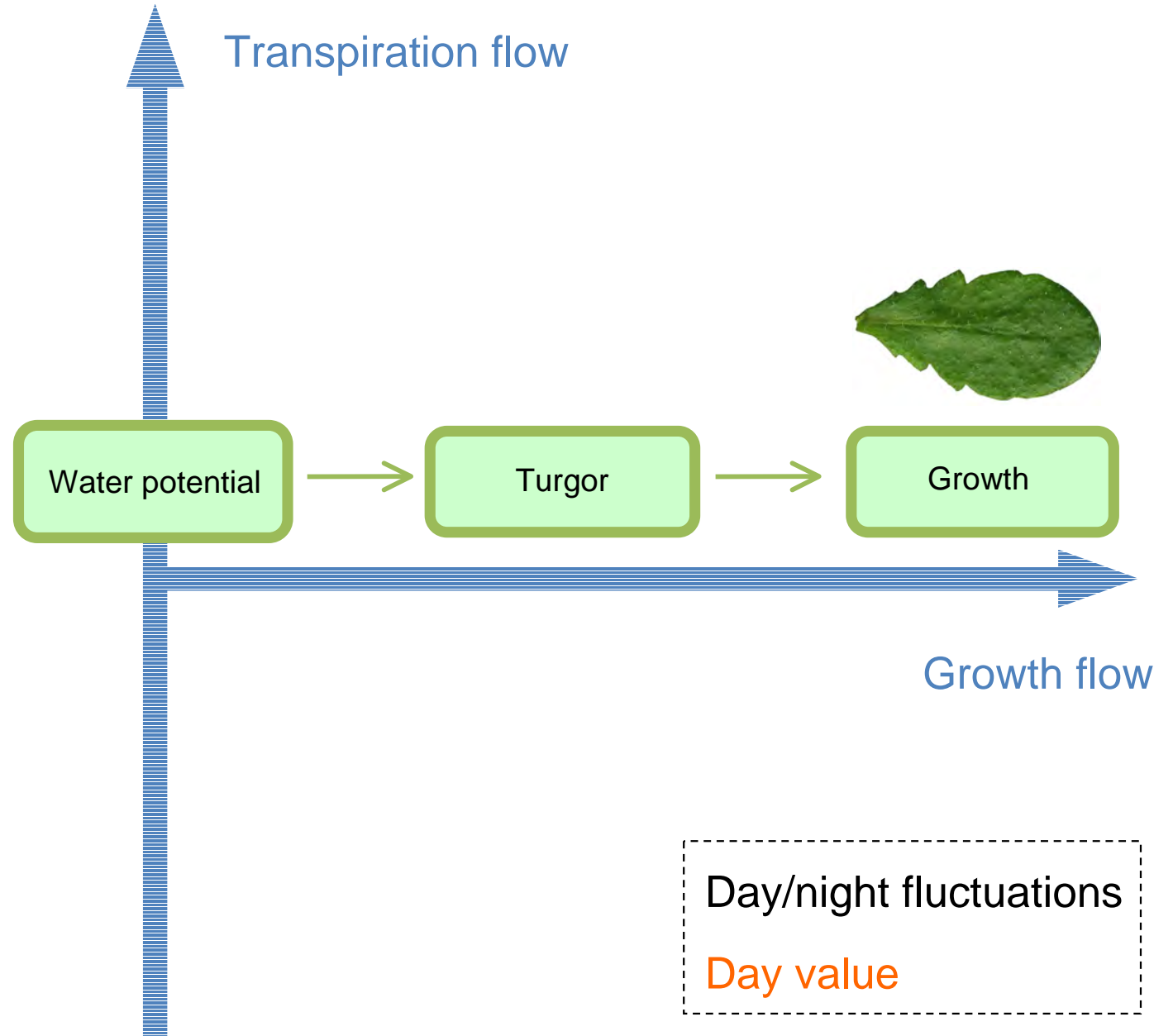

# Leaf growth: establishment of hydraulic control

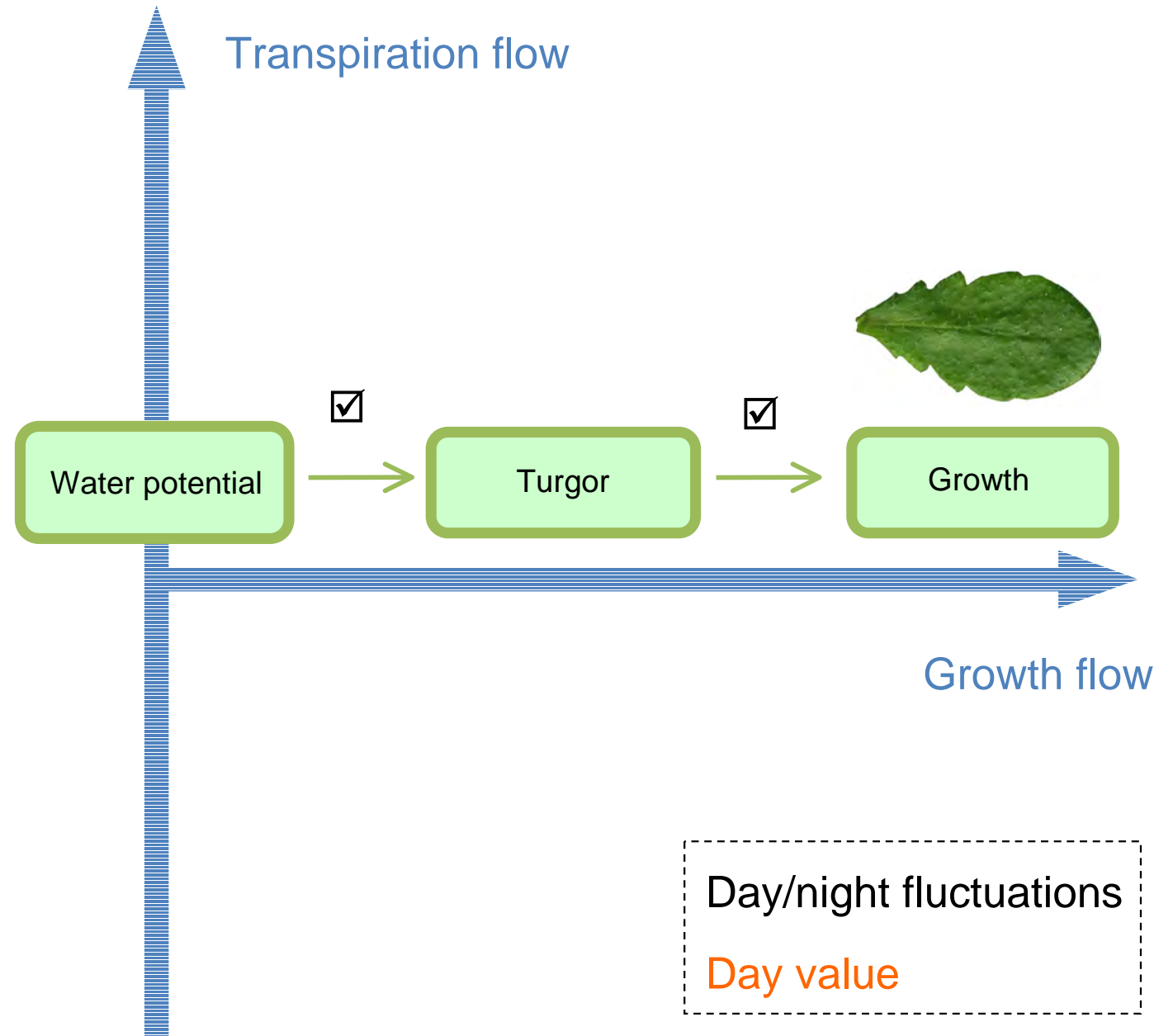

# Leaf growth: establishment of hydraulic control

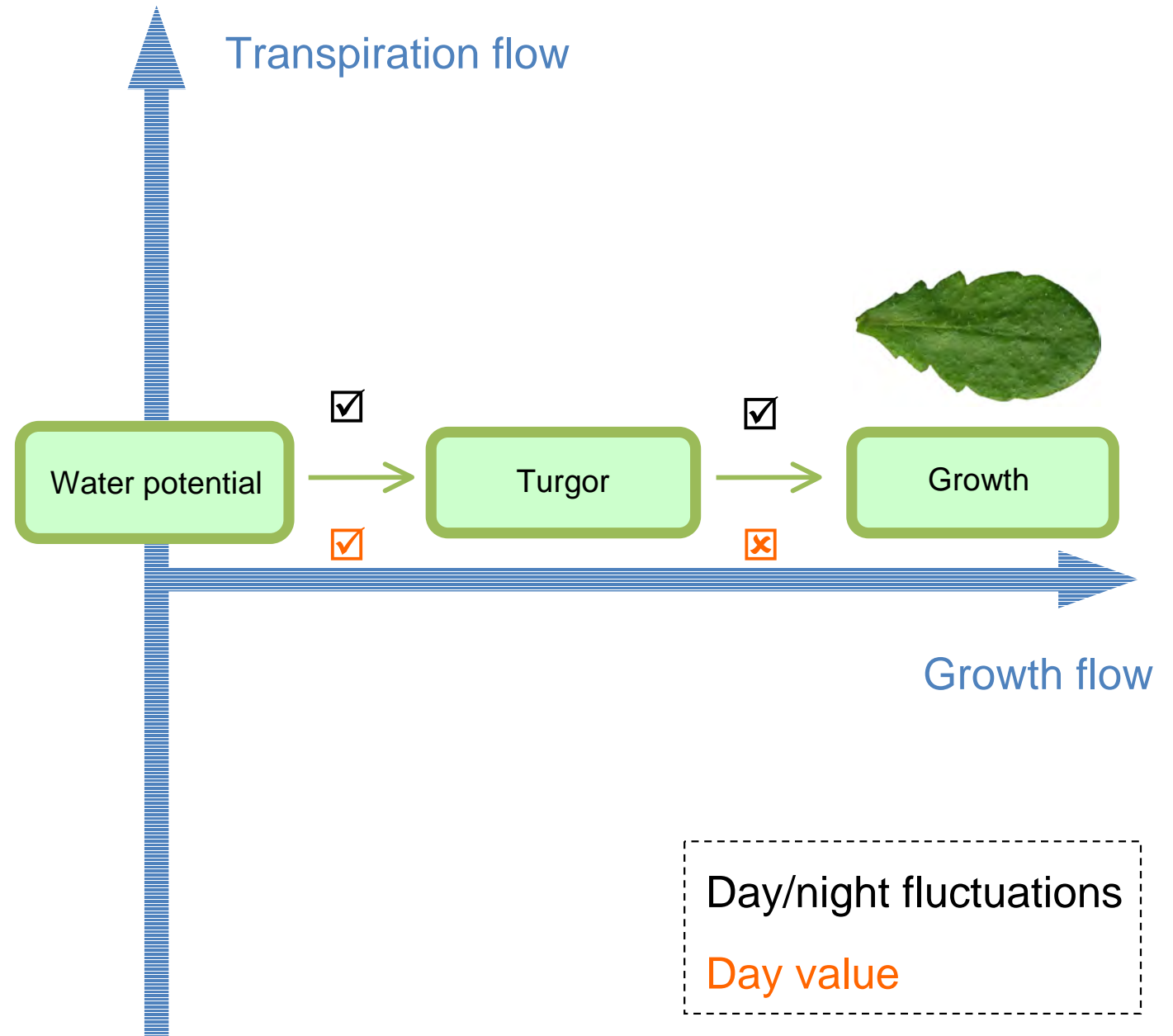

# Leaf growth: establishment of hydraulic control

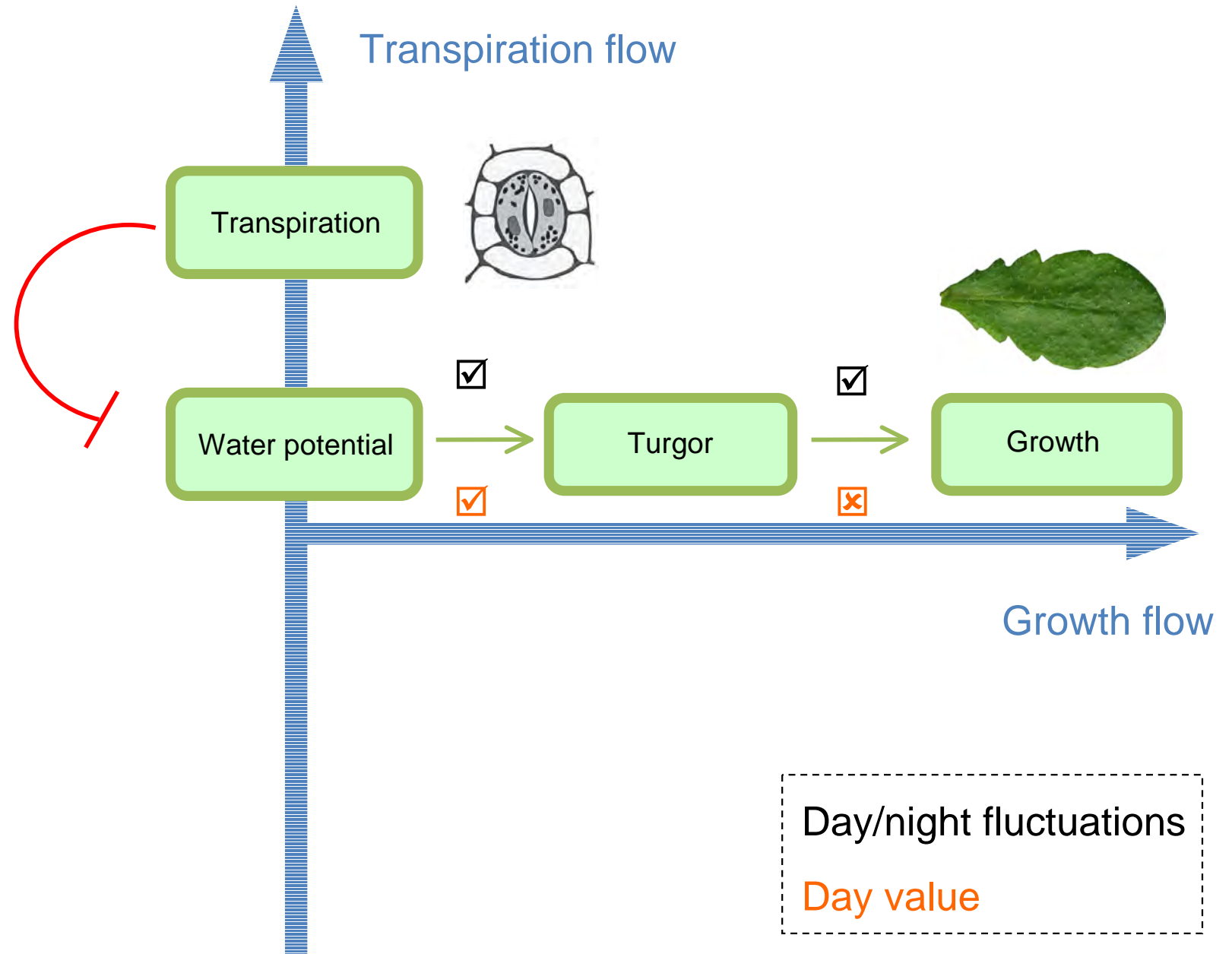

# Leaf growth: establishment of hydraulic control

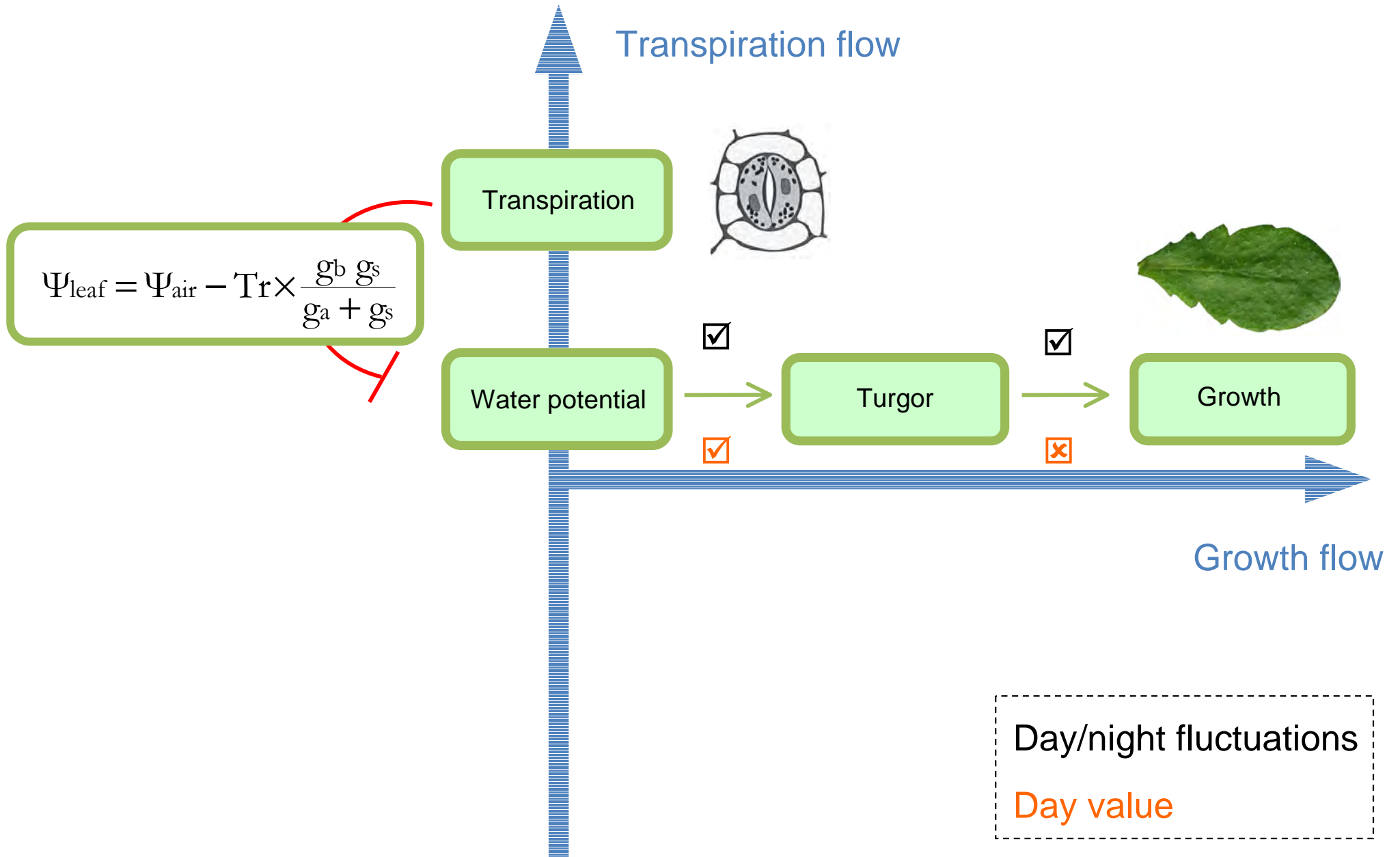

# Transpiration

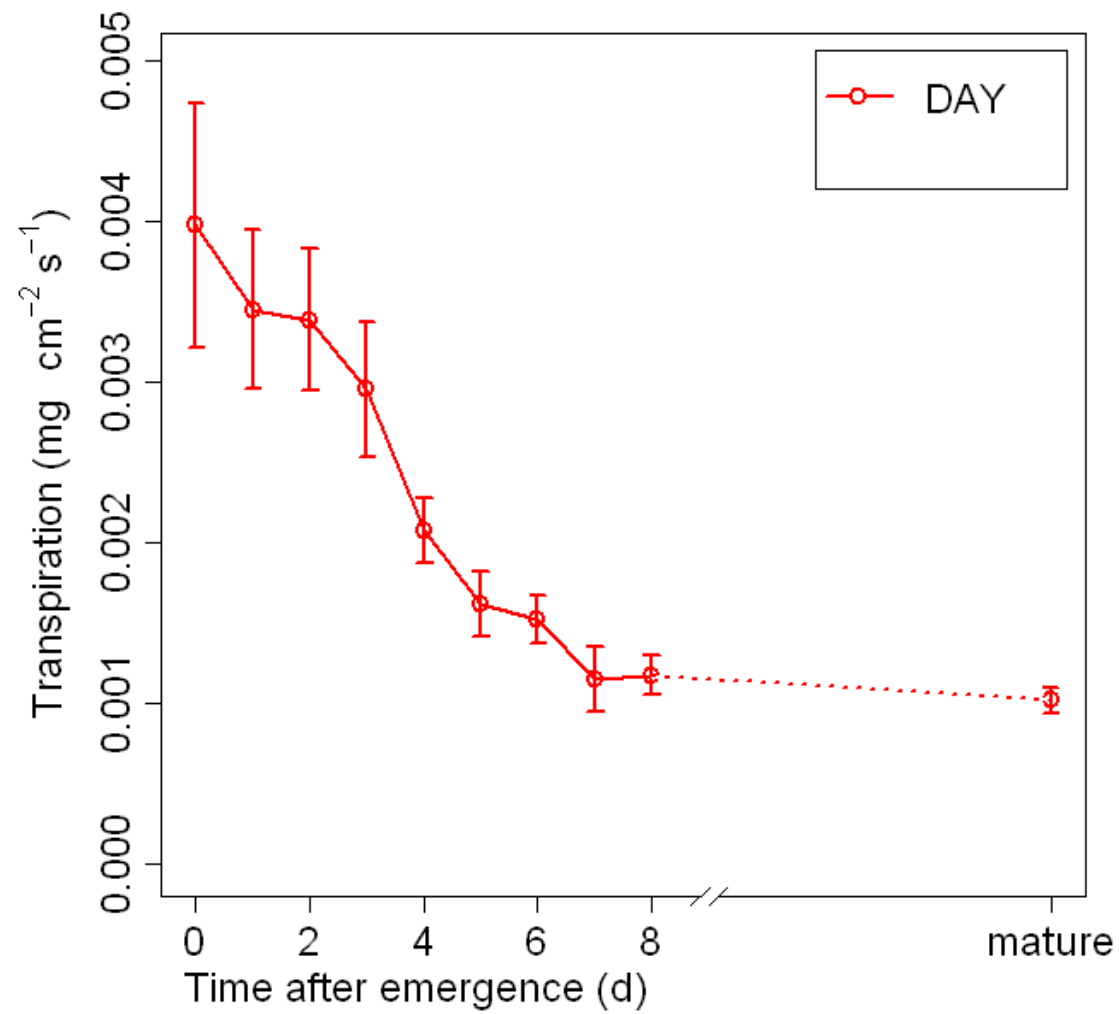



# Transpiration

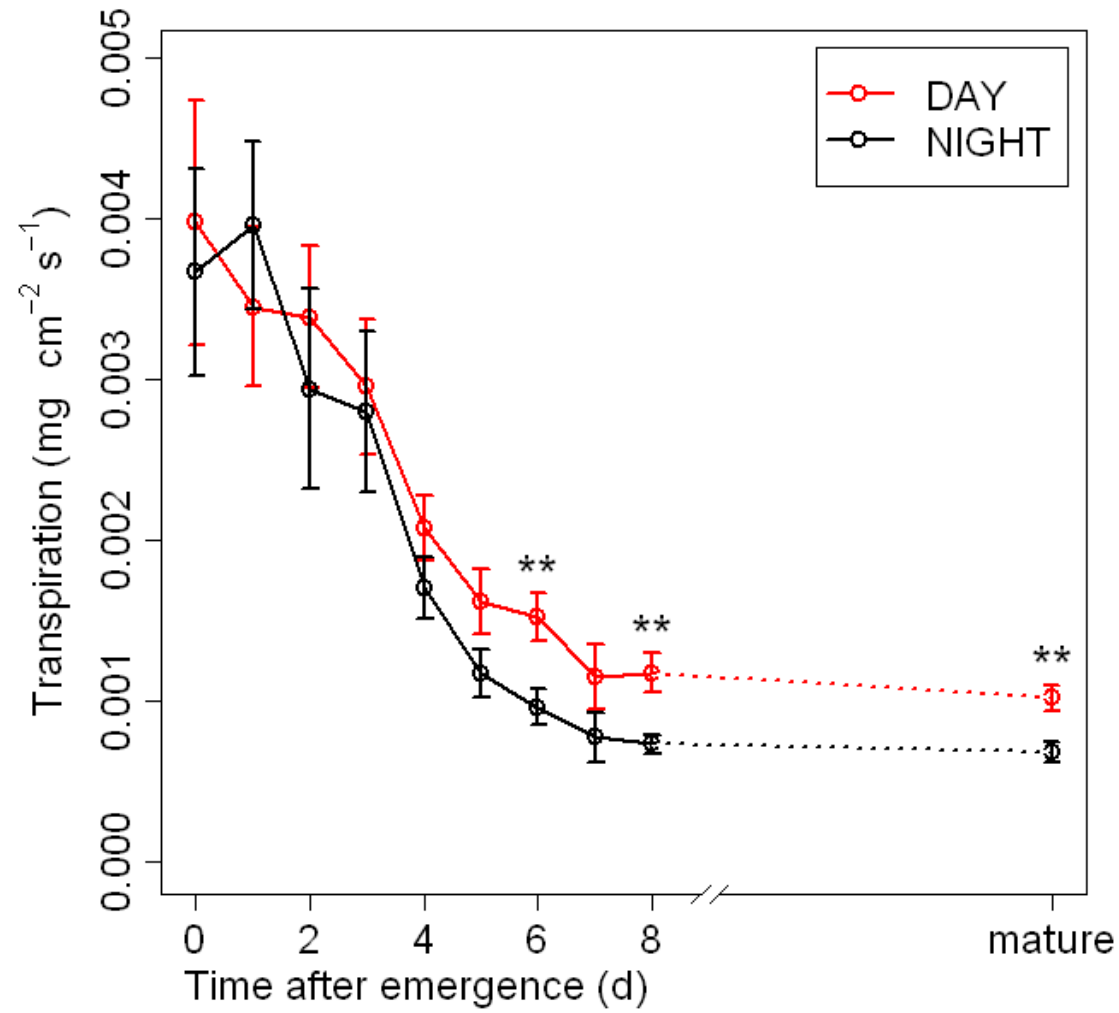

# Transpiration

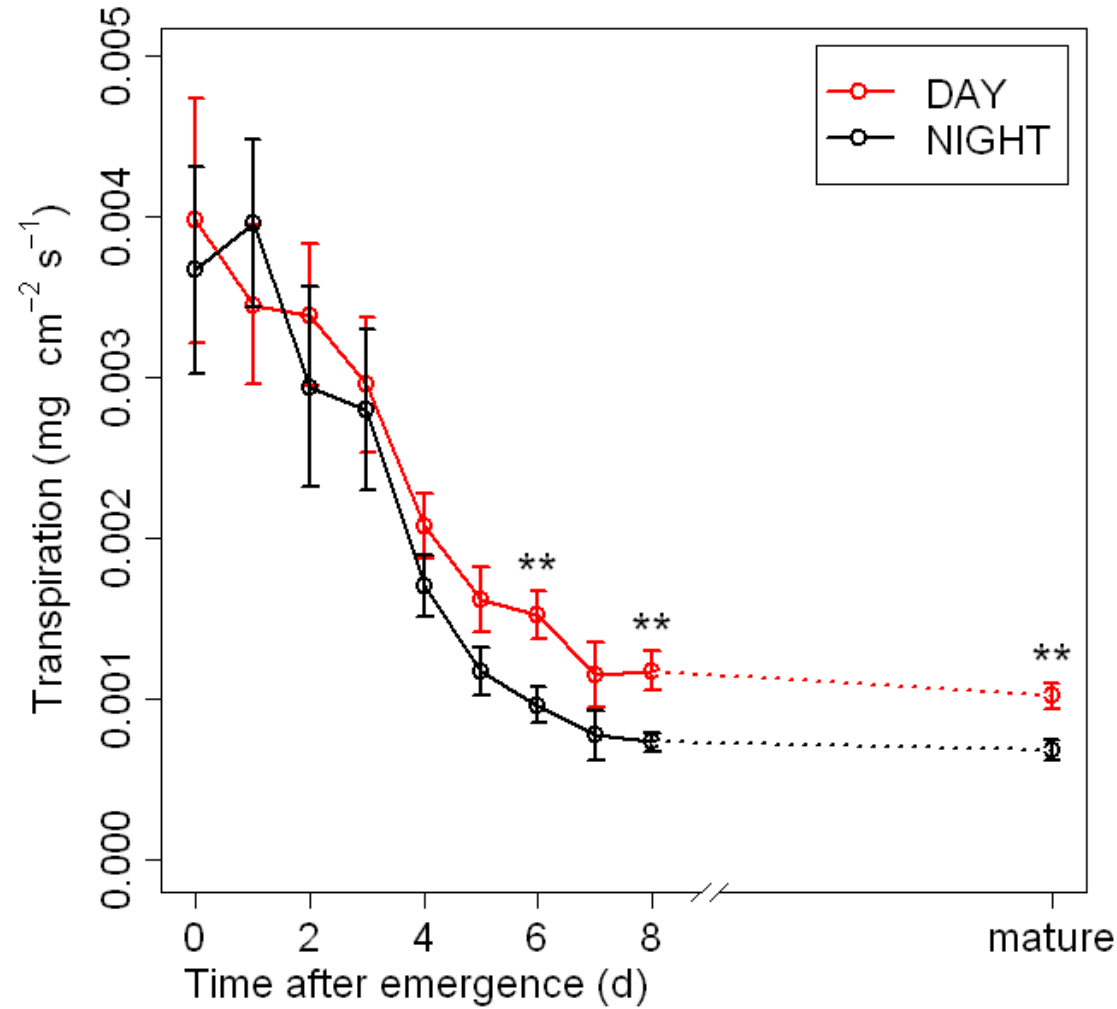

⇒ Changes in day/night differences of transpiration are consistent with potentials and expansion developmental patterns

# Leaf growth: establishment of hydraulic control

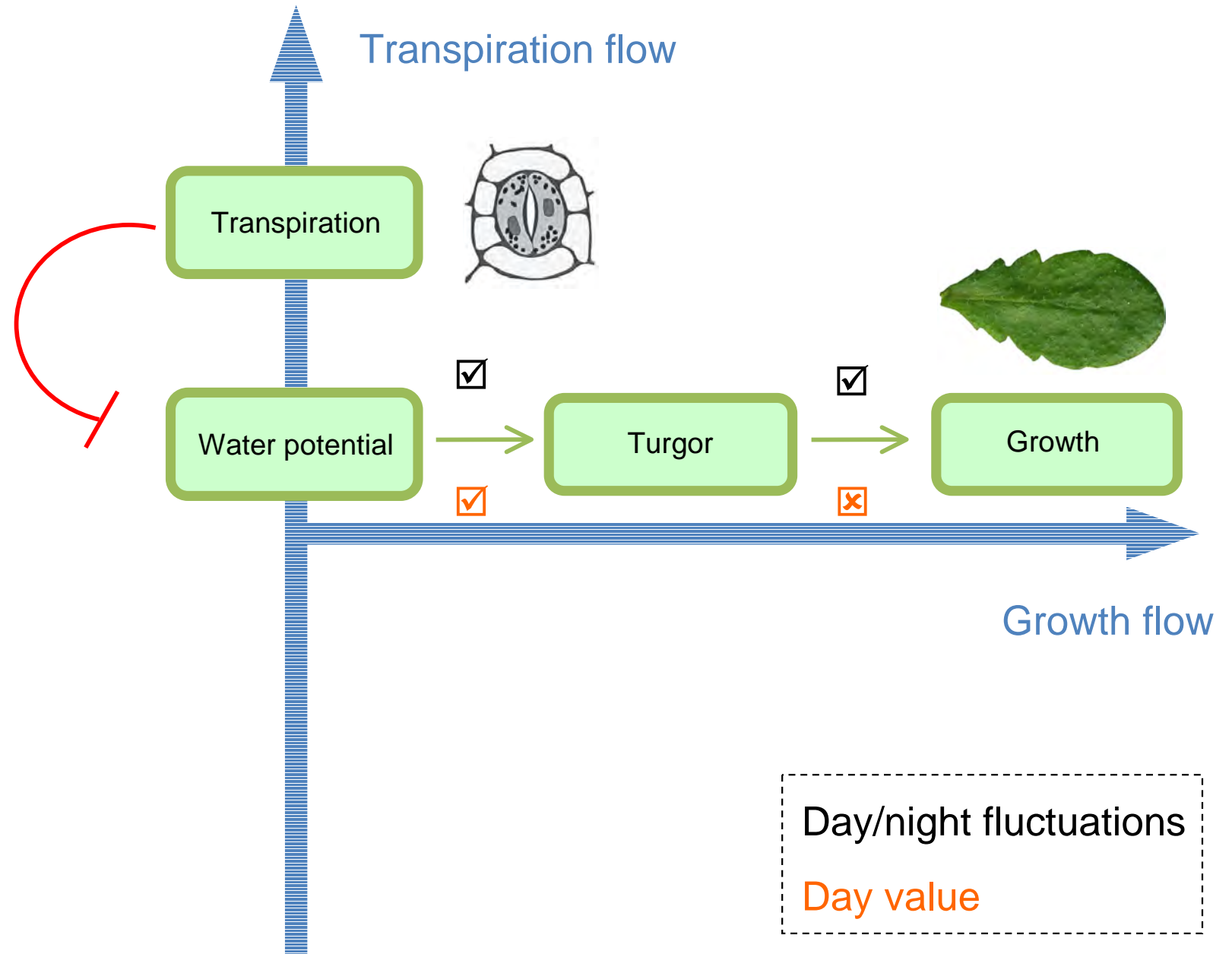

# Leaf growth: establishment of hydraulic control

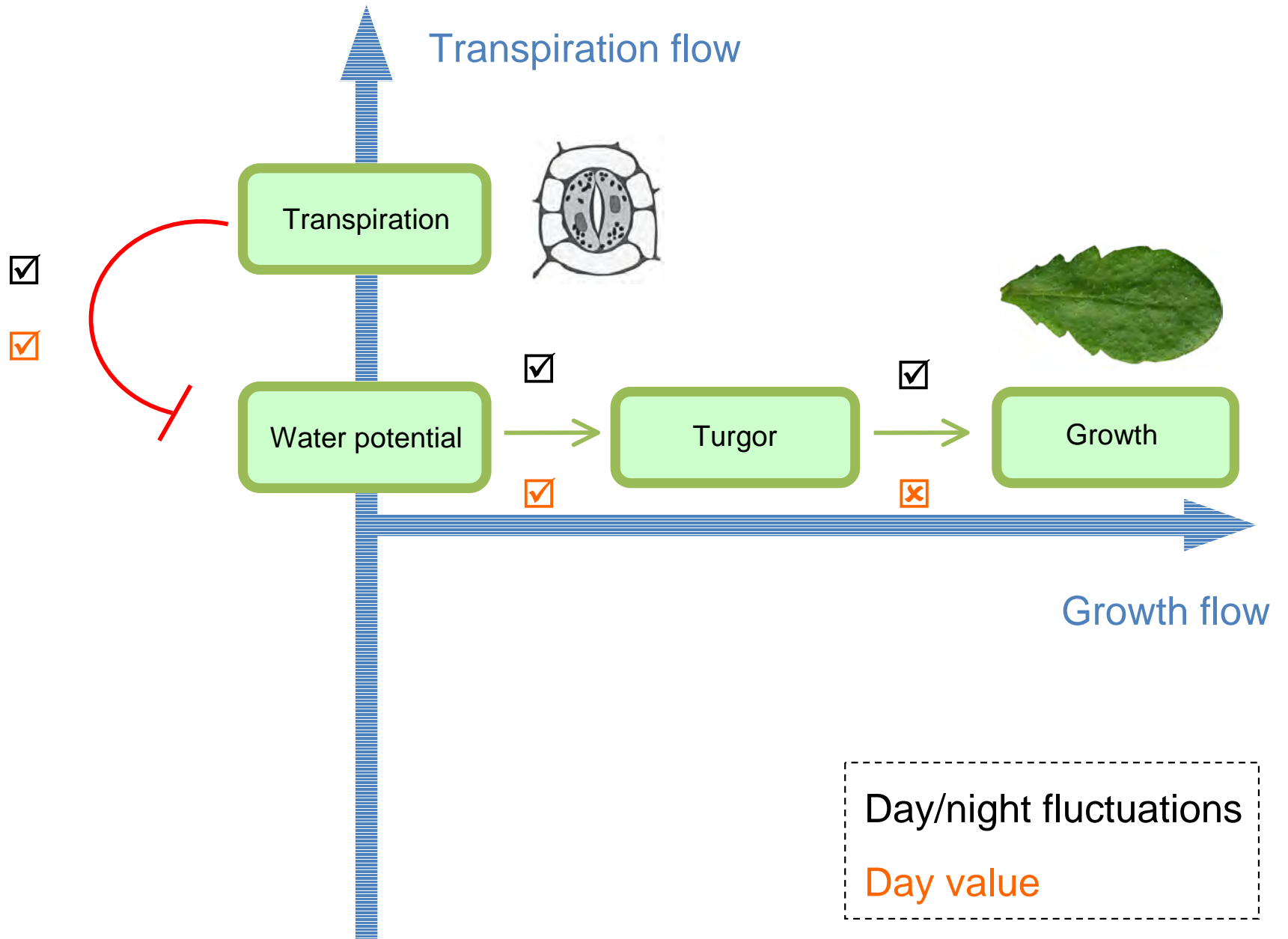



**Leaf growth: establishment of hydraulic control**

– II –

Why no difference between day and night  
transpiration in the young leaf?

Putative role of stomata and cuticle

# Changes in day/night difference of transpiration

In the early stages, why is transpiration higher than in later stages and not lower at night?

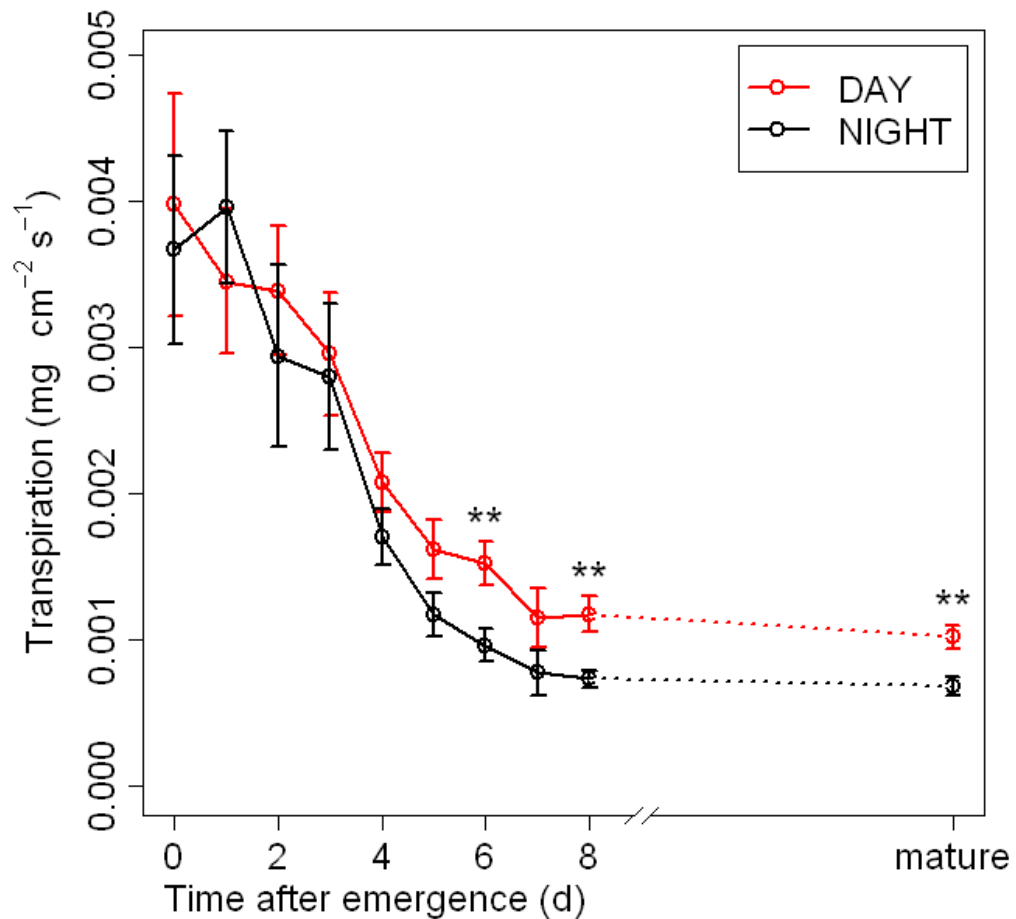

# Changes in day/night difference of transpiration

In the early stages, why is transpiration higher than in later stages and not lower at night?

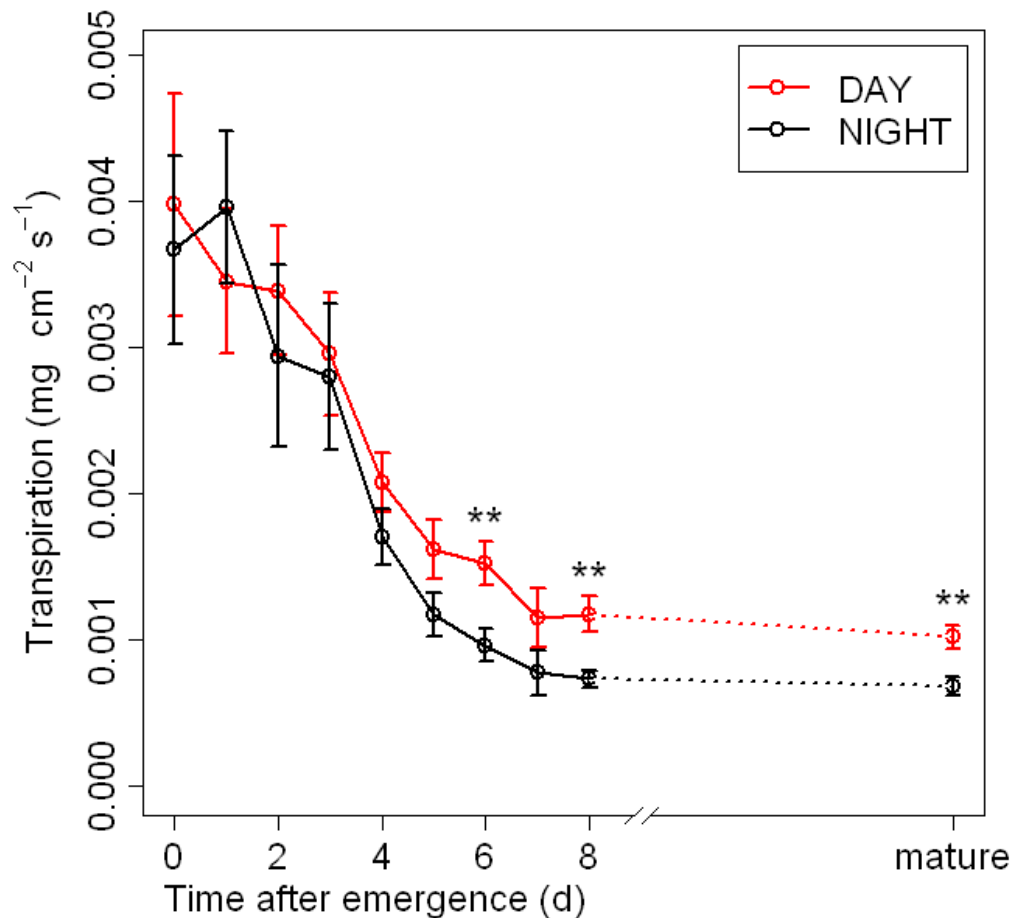

- Stomata contribution to transpiration is negligible in the early stages?

↳ Young cuticle is more permeable (thickness? composition?)

- Stomata are always largely open in the early stages?

# Response to abscisic acid

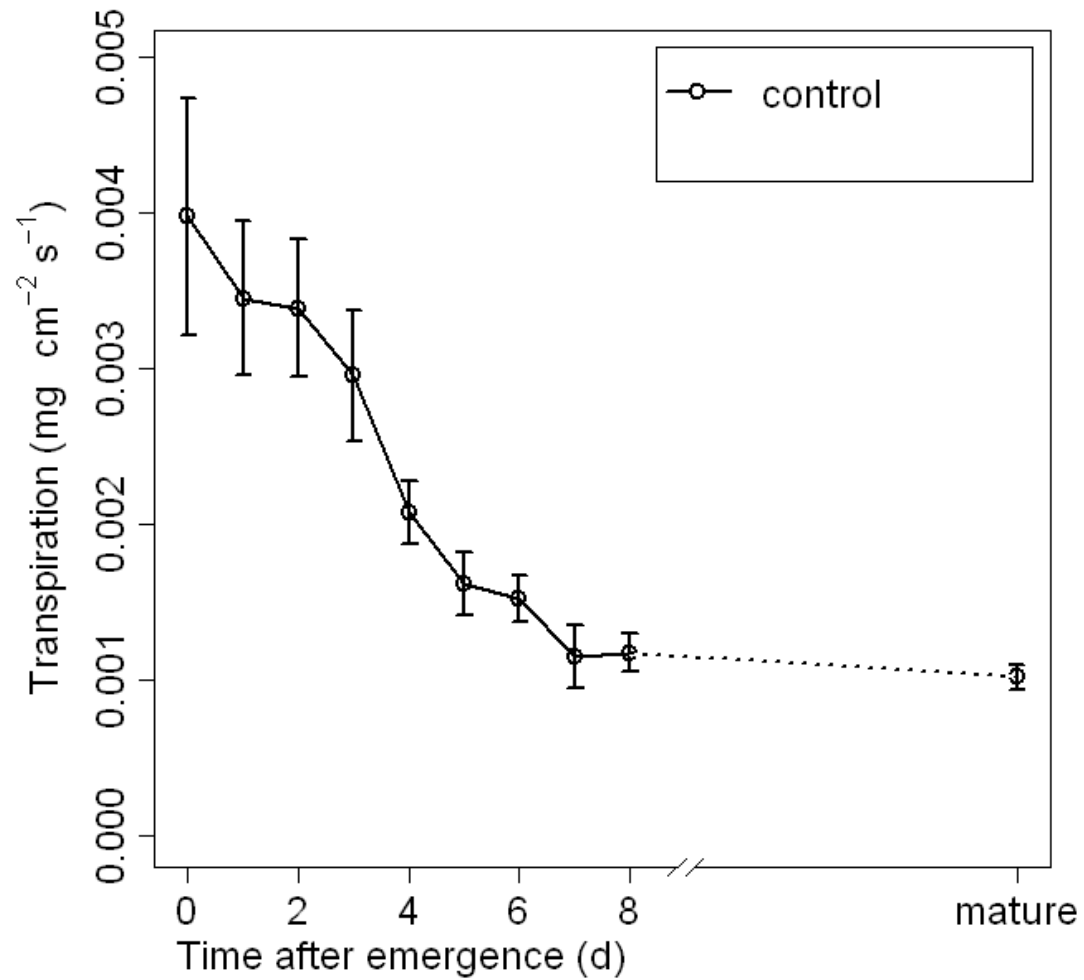



# Response to abscisic acid

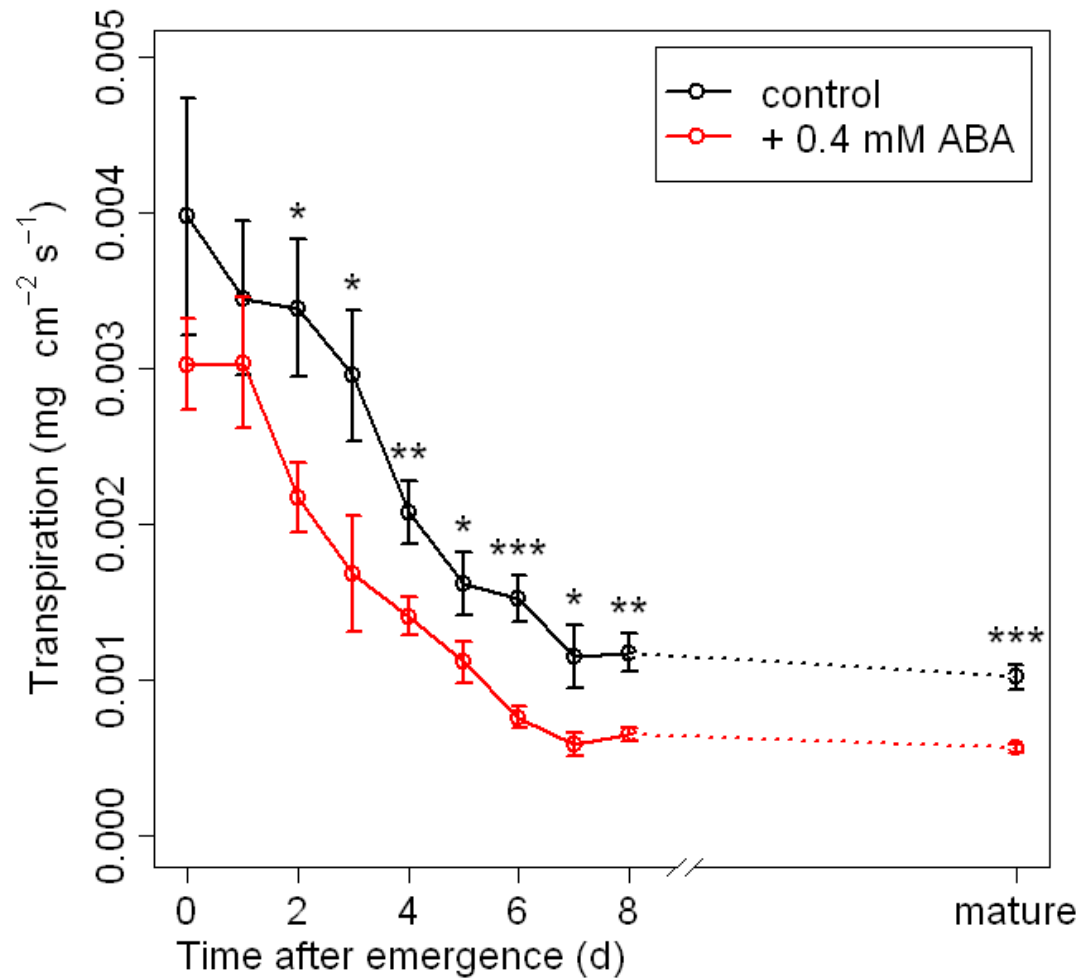

# Response to abscisic acid

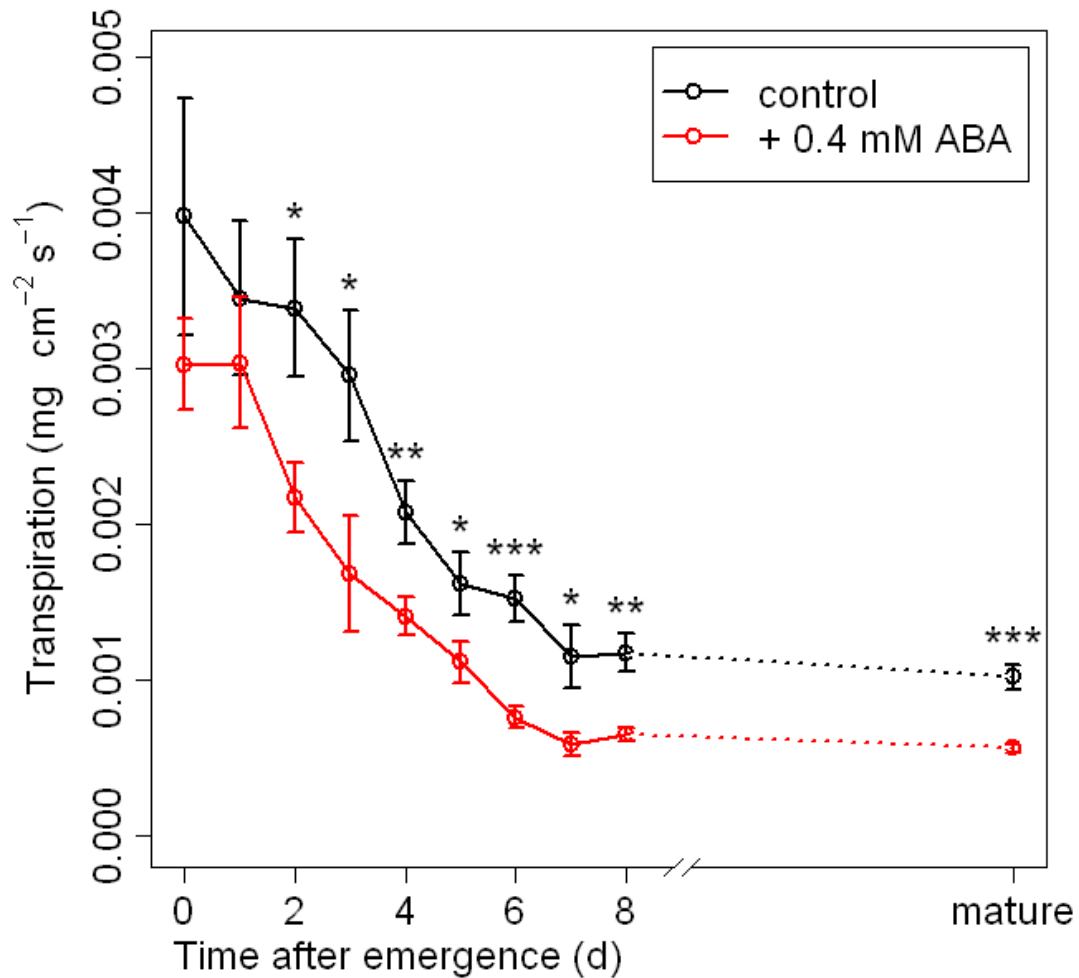

The effect of ABA in the early stages, even weak, is not consistent with a transpiration from the cuticle solely

# Transpiration of an open stomata mutant

## Wild-type Col-0

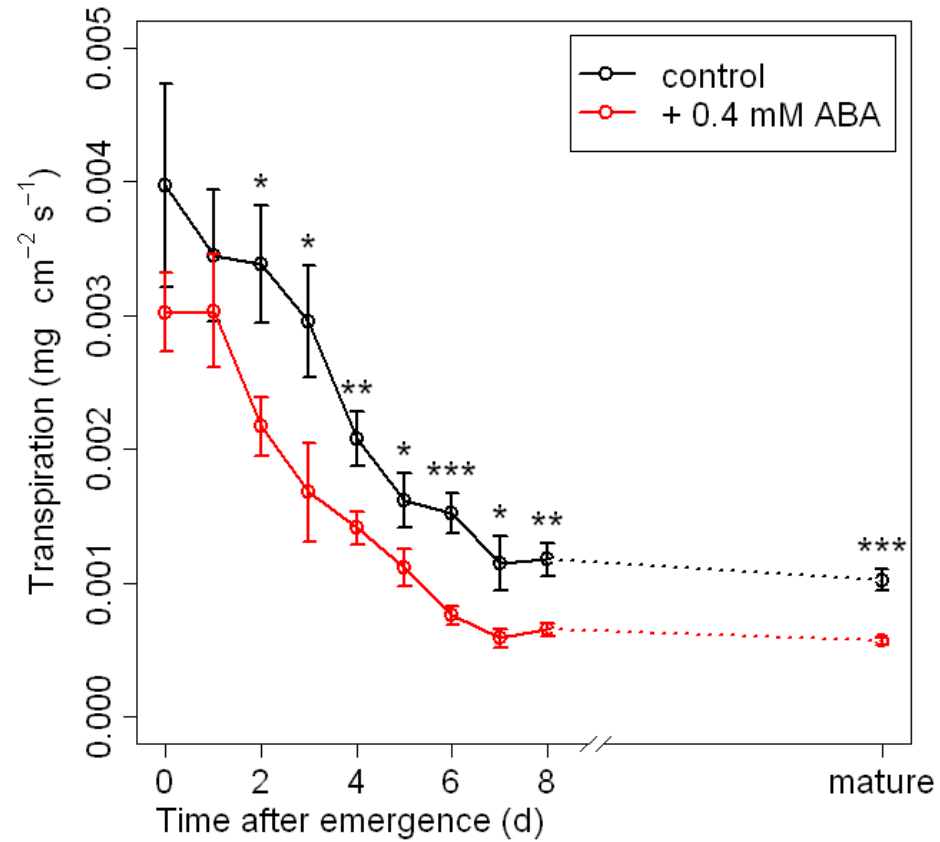

# Transpiration of an open stomata mutant

Wild-type Col-0

Open stomata *ost2* (ABA insensitive)

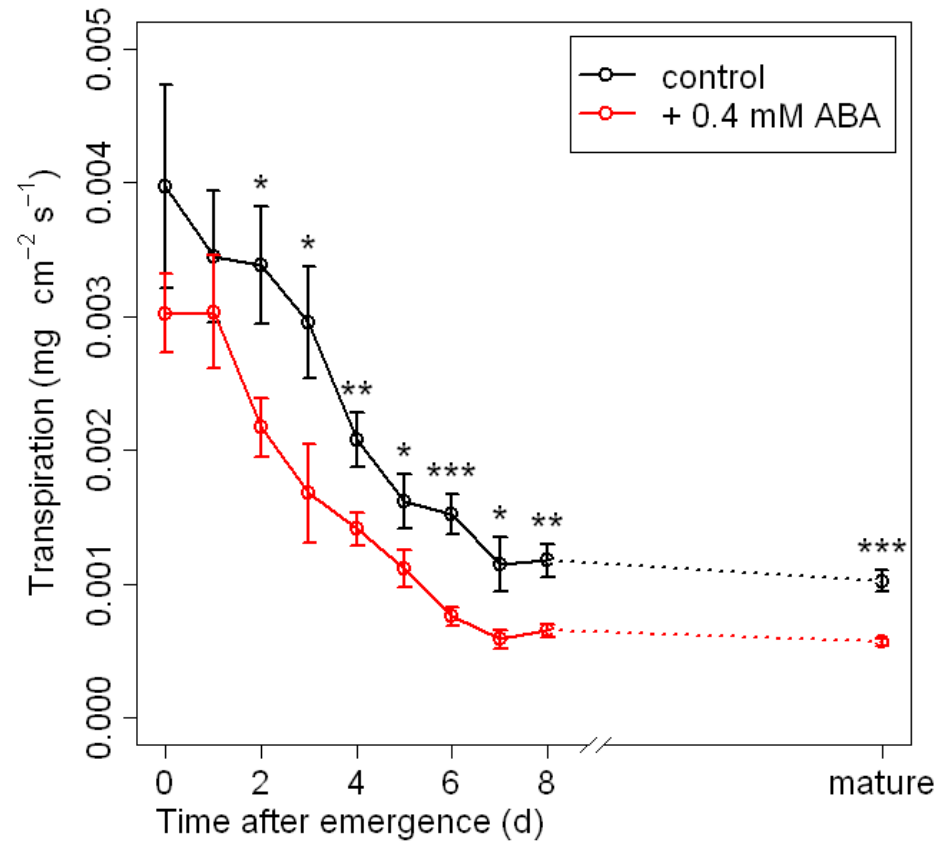

# Transpiration of an open stomata mutant

## Wild-type Col-0

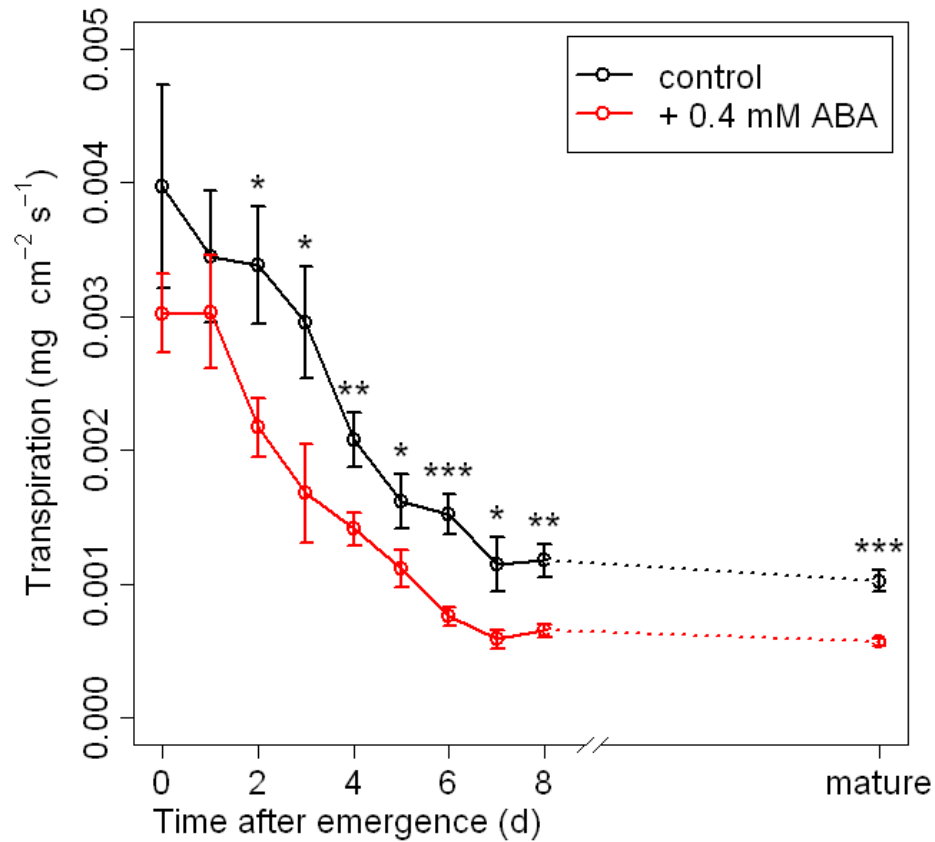

## Open stomata *ost2* (ABA insensitive)

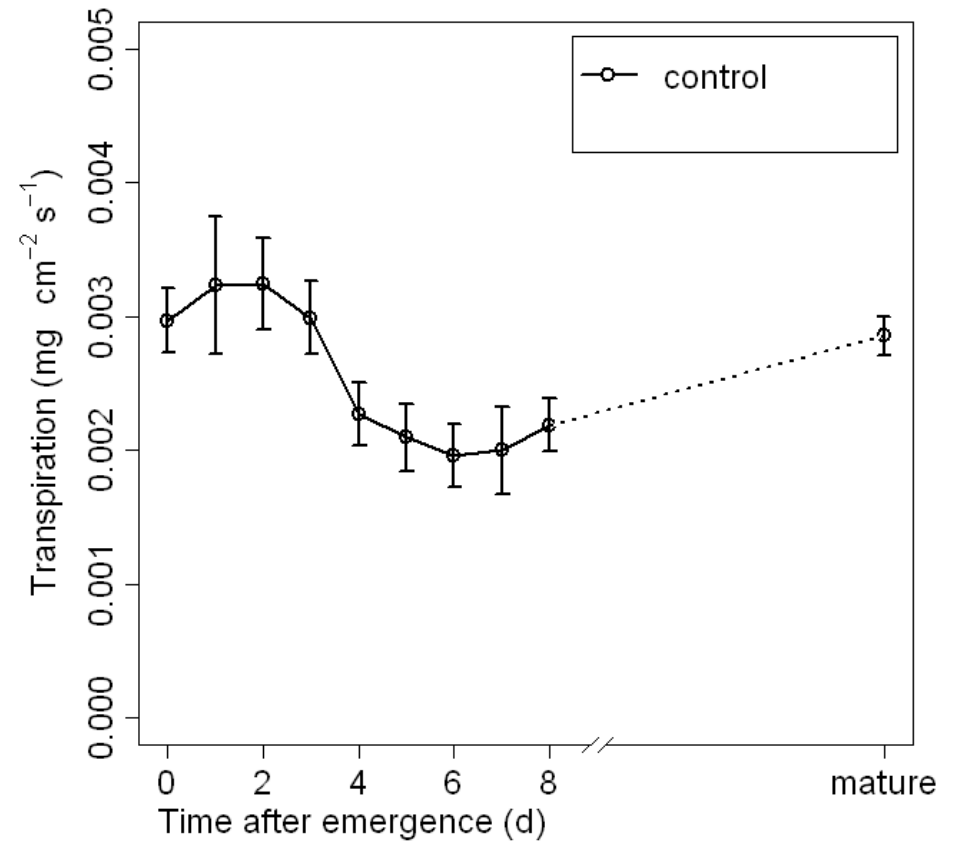

# Transpiration of an open stomata mutant

## Wild-type Col-0

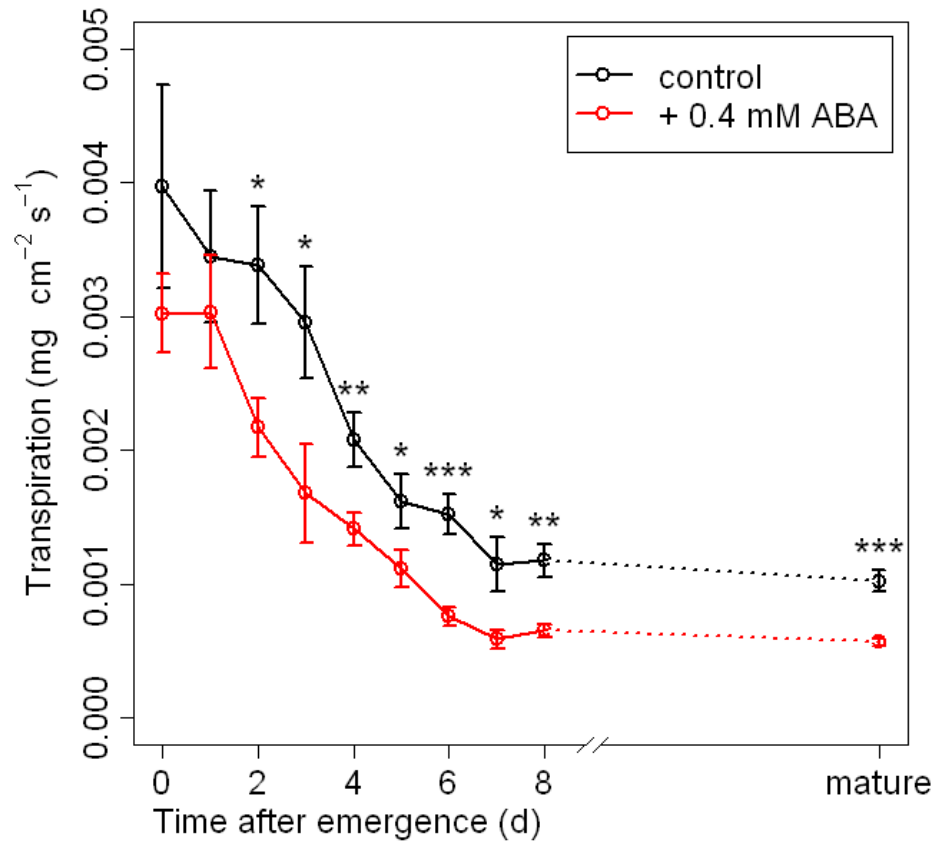

## Open stomata *ost2* (ABA insensitive)

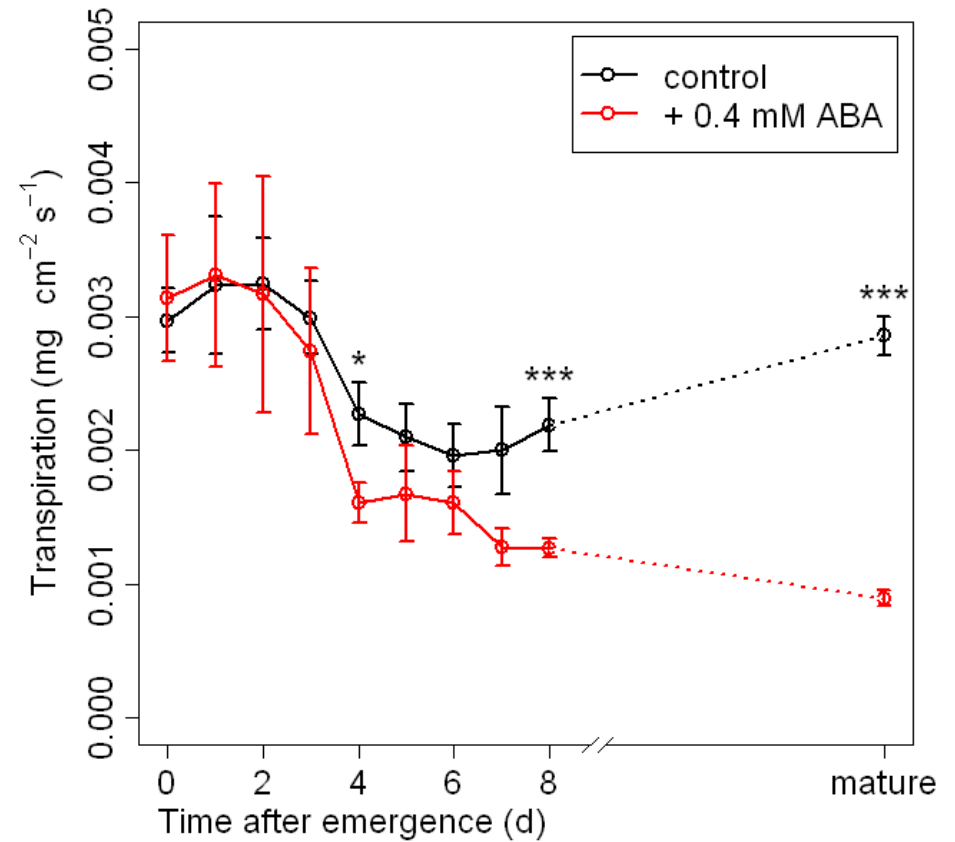

# Transpiration of an open stomata mutant

## Wild-type Col-0

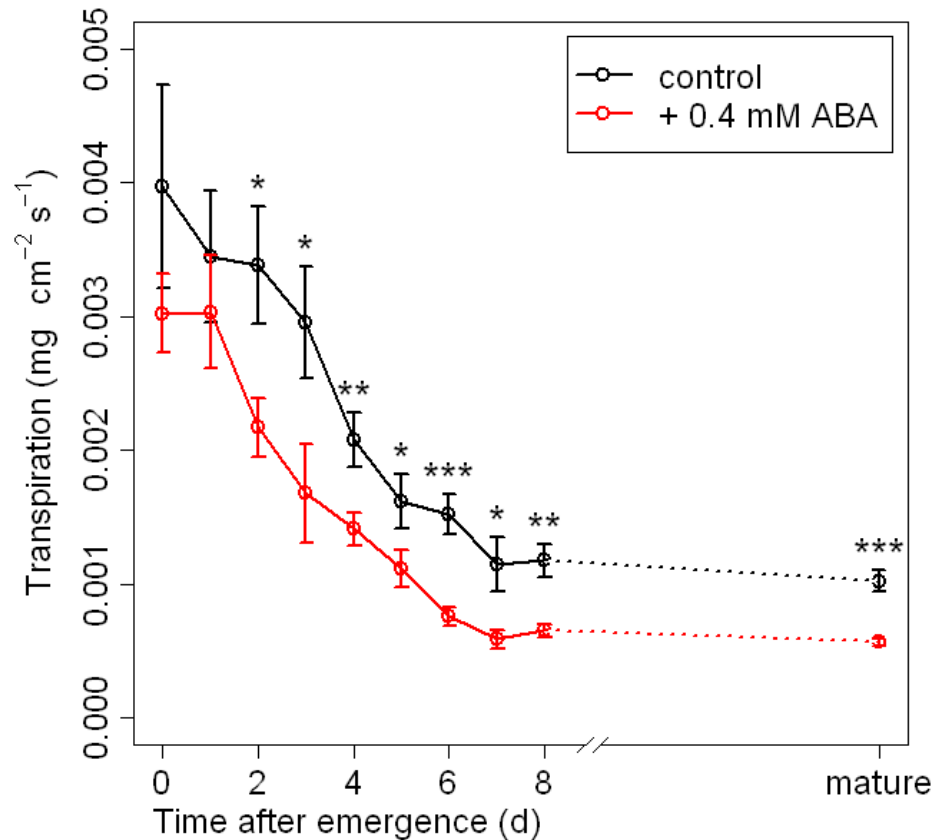

## Open stomata *ost2* (ABA insensitive)

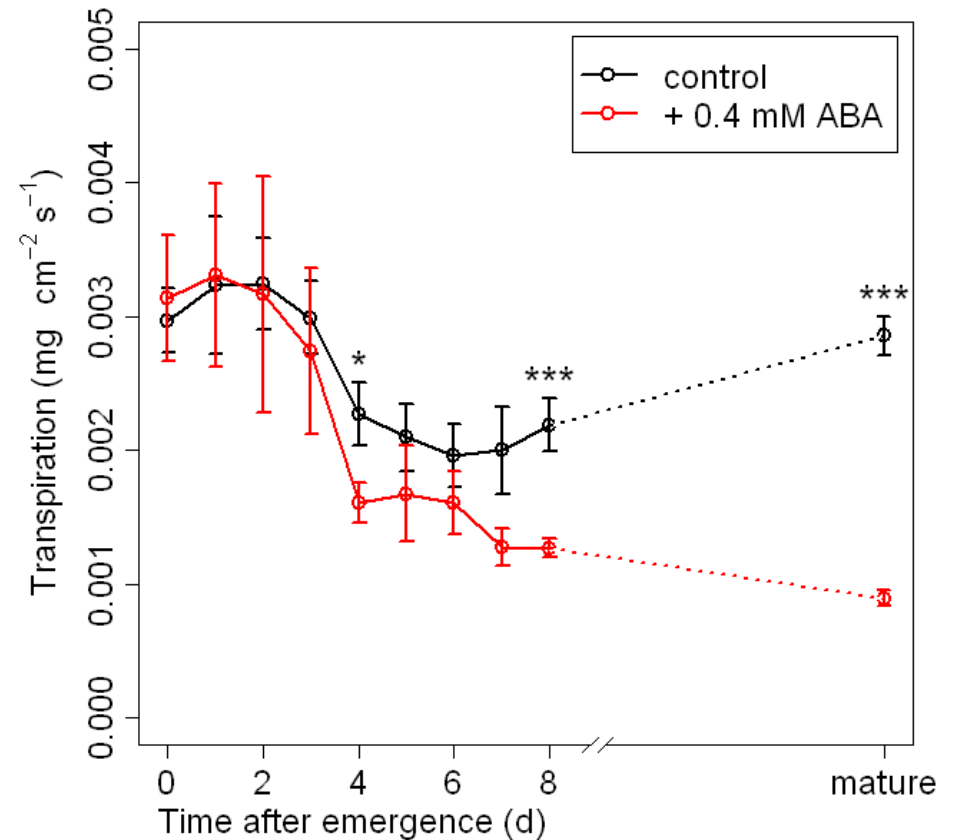

A developmental trend in stomatal aperture in line with stomatal sensitivity or functioning?



## Changes in day/night difference of transpiration

**In the early stages, why is transpiration higher than in later stages  
and not lower at night?**

- Young stomata are insensitive?
- Young stomata are functional AND subjected to an endogenous stimulus?



# Changes in day/night difference of transpiration

**In the early stages, why is transpiration higher than in later stages and not lower at night?**

- Young stomata are insensitive?
- Young stomata are functional AND subjected to an endogenous stimulus?

To be performed (Jeanne Renaud, M2):

- **Morphological observations** under cryoscanning electron microscopy look at native stomatal aperture
- Experiments on **epidermal strips** (coll. A. Vavasseur, CEA Cadarache) to evaluate a putative developmental acquisition of stomatal sensitivity to several effectors (fusicochin, light, ABA, CO<sub>2</sub>)
- **Day/night transpiration** on several mutants or environments to test the nature of the stimulus that would open the young stoma at night

# Leaf growth: establishment of hydraulic control

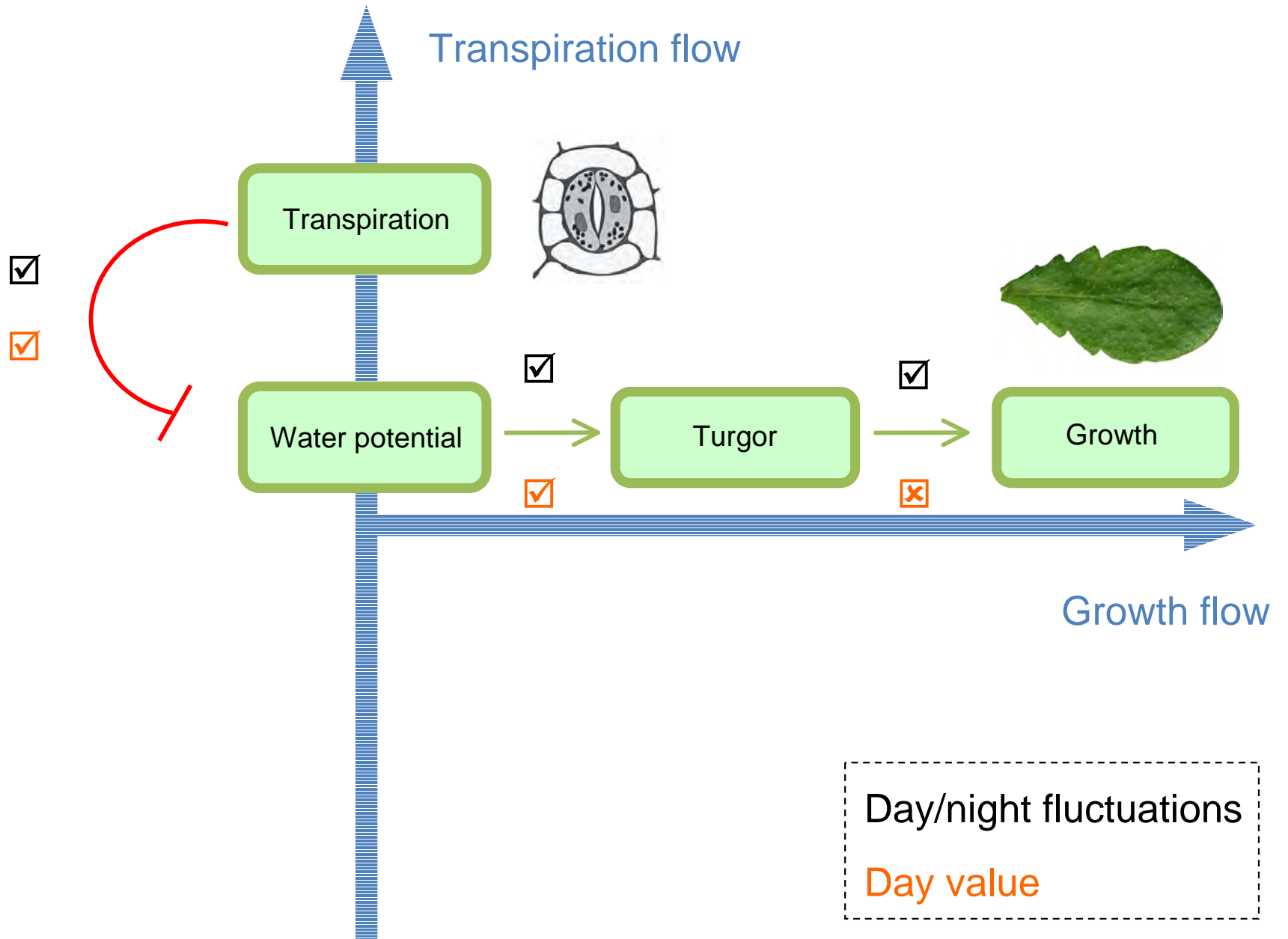

# Leaf growth: establishment of hydraulic control

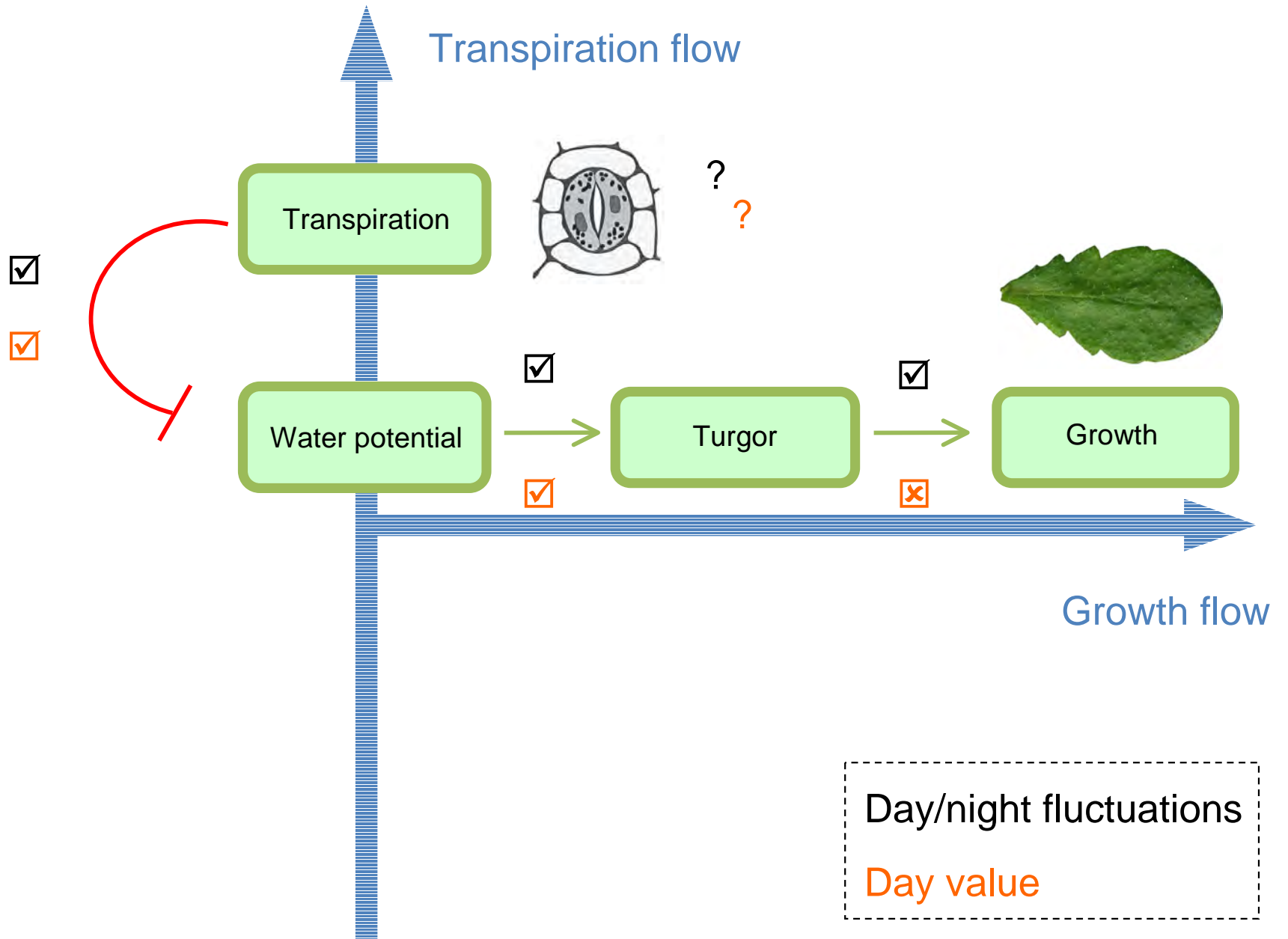

# Leaf growth: establishment of hydraulic control

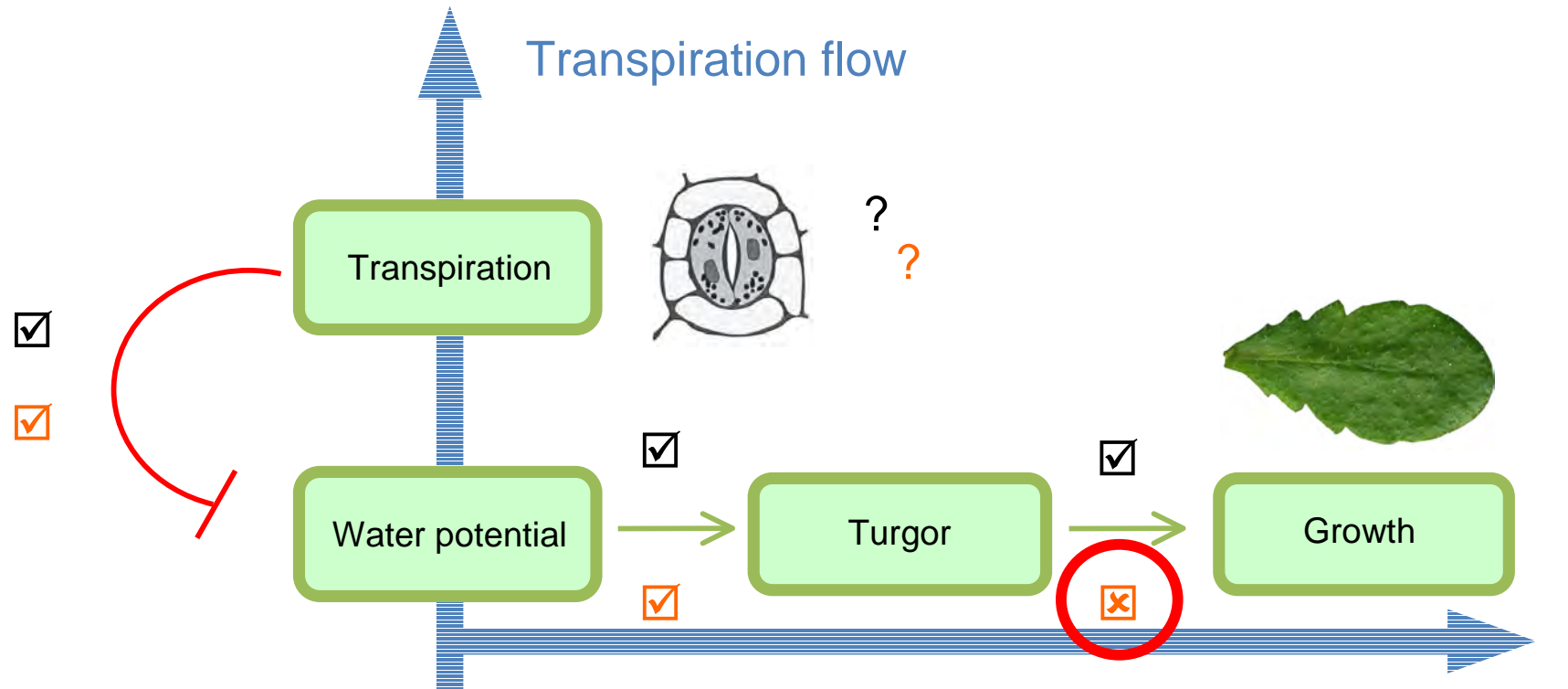

Young leaves display higher RER despite lower turgor and higher transpiration

- High wall extensibility allows expansion at lower water potentials?
- Transpiration is balanced by a high supply capacity?

Day/night fluctuations

Day value



Leaf growth: establishment of hydraulic control

– III –

How does young leaf sustain high growth rate despite high transpiration?

Contribution of xylem and aquaporins to leaf hydraulic conductance

(preliminary results)

# Leaf growth: establishment of hydraulic control

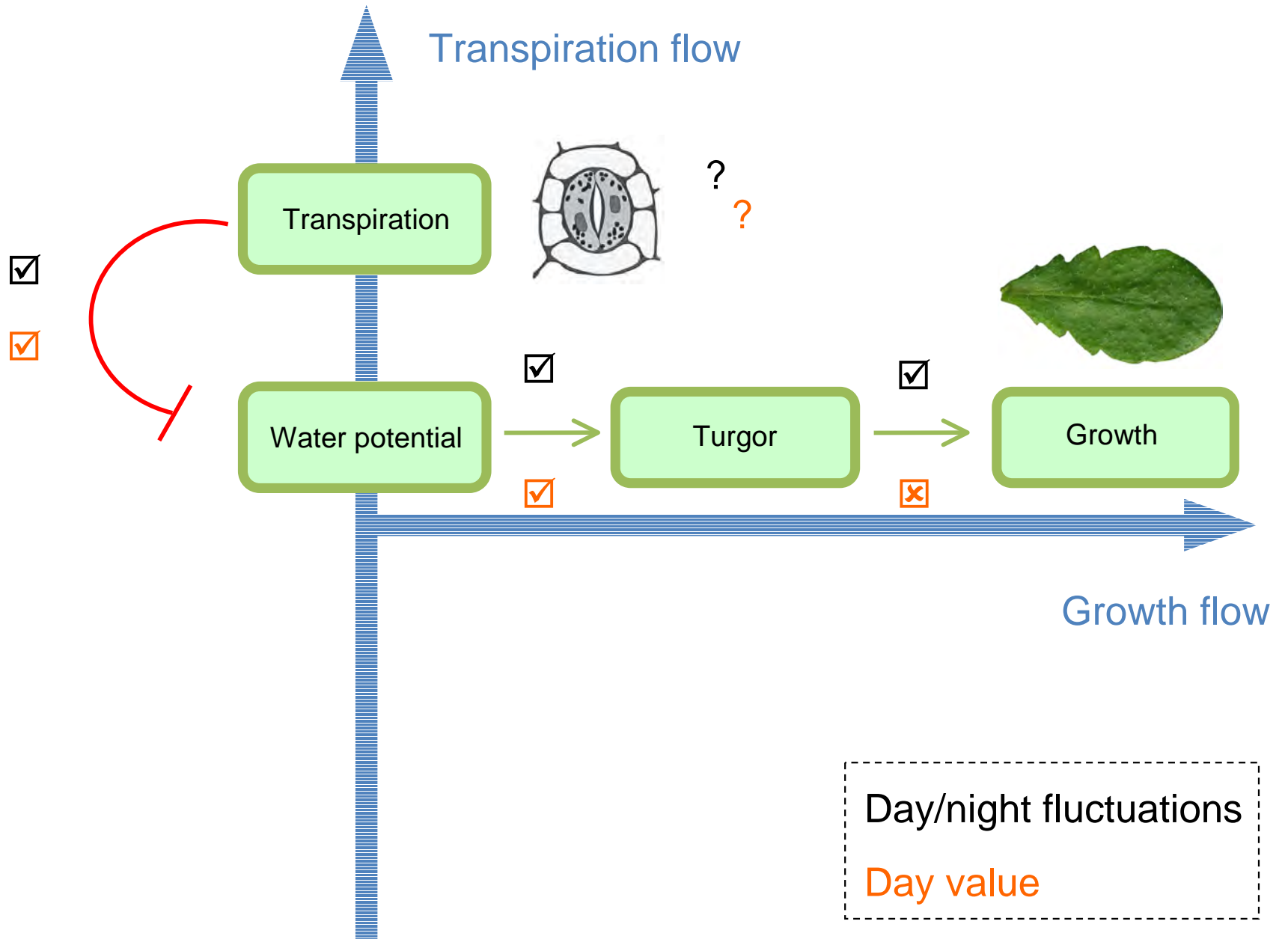

# Leaf growth: establishment of hydraulic control

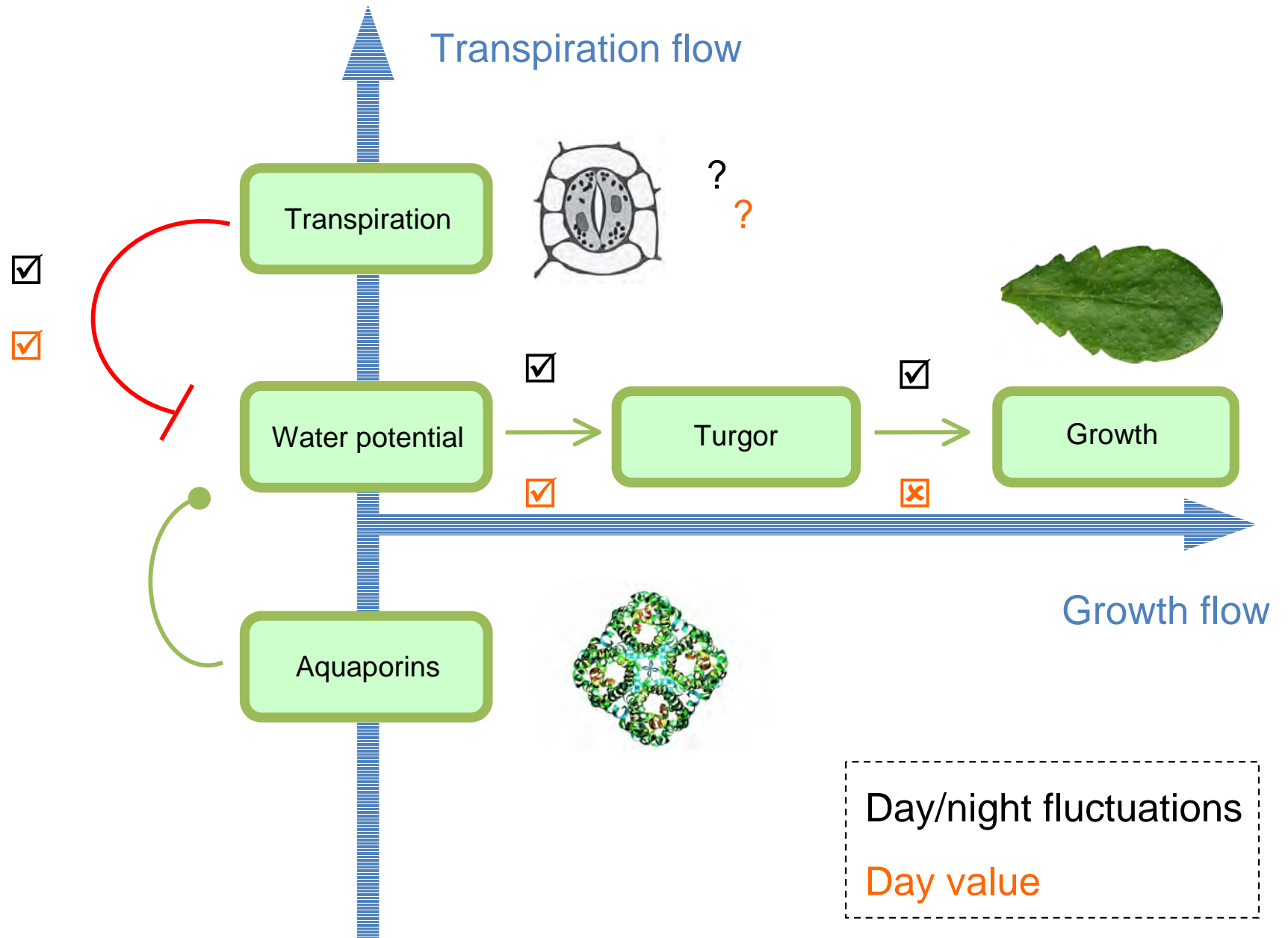

# Leaf growth: establishment of hydraulic control

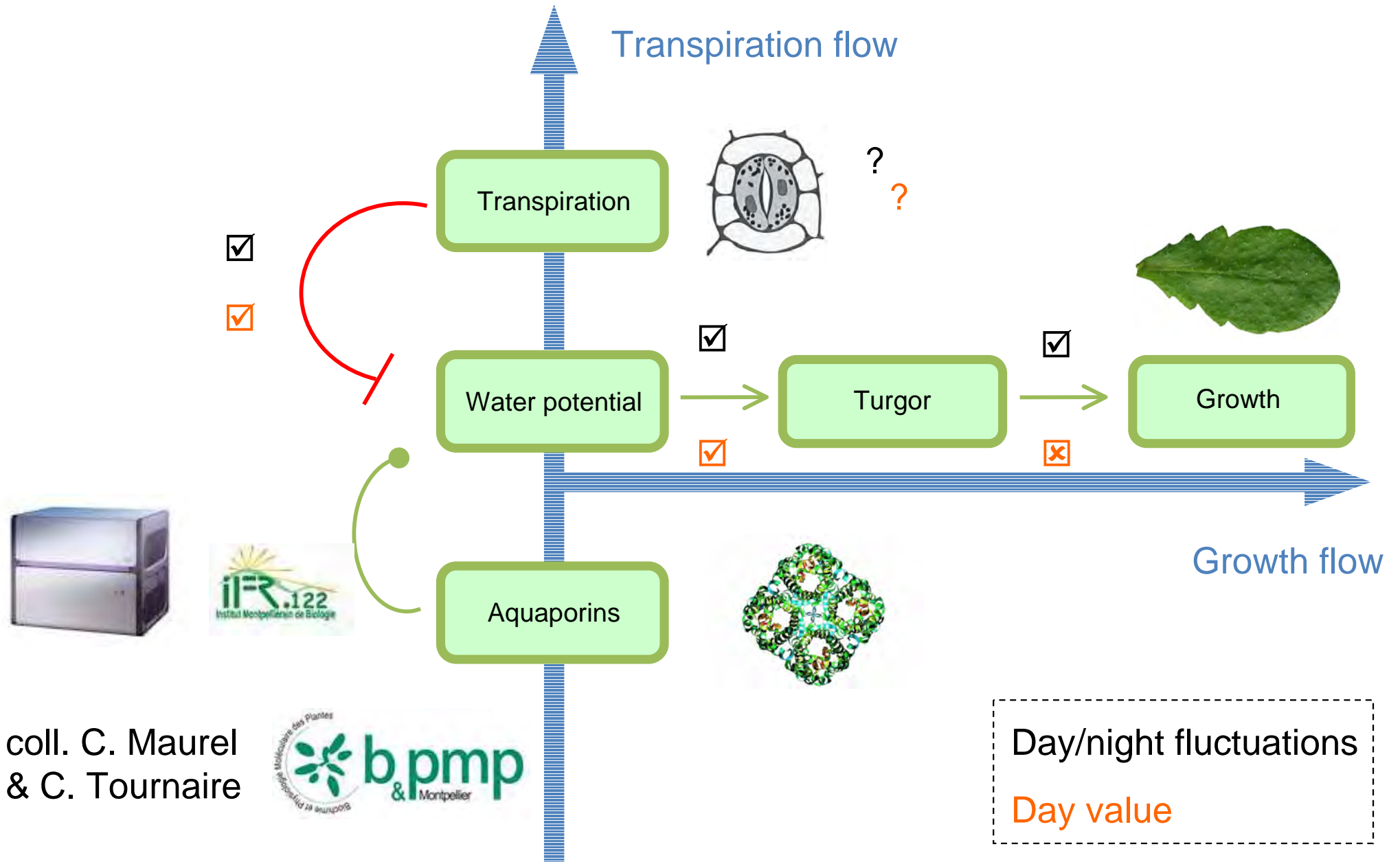

coll. C. Maurel  
& C. Tournaire



Day/night fluctuations  
Day value



# PIPs expression

> PIPs are differentially expressed during leaf development

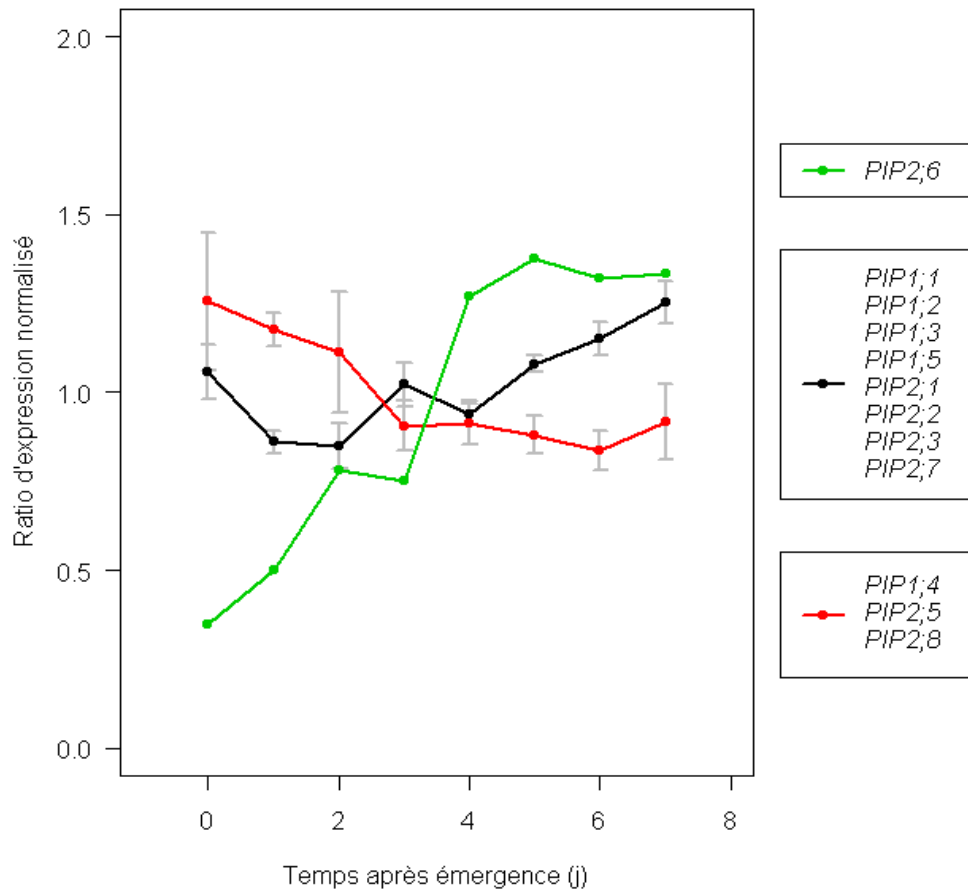

**DAY**

# PIPs expression

- > *PIPs* are differentially expressed during leaf development
- > At night, "ascending" cluster is appended with 4 more *PIPs*

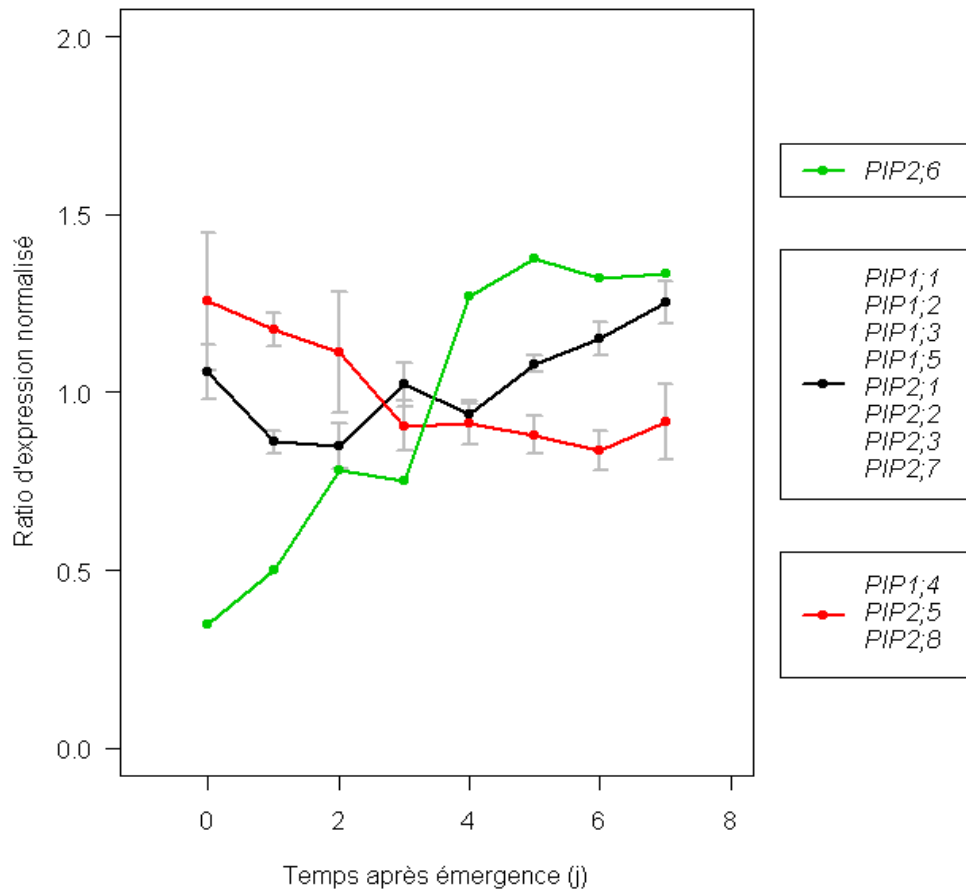

**DAY**

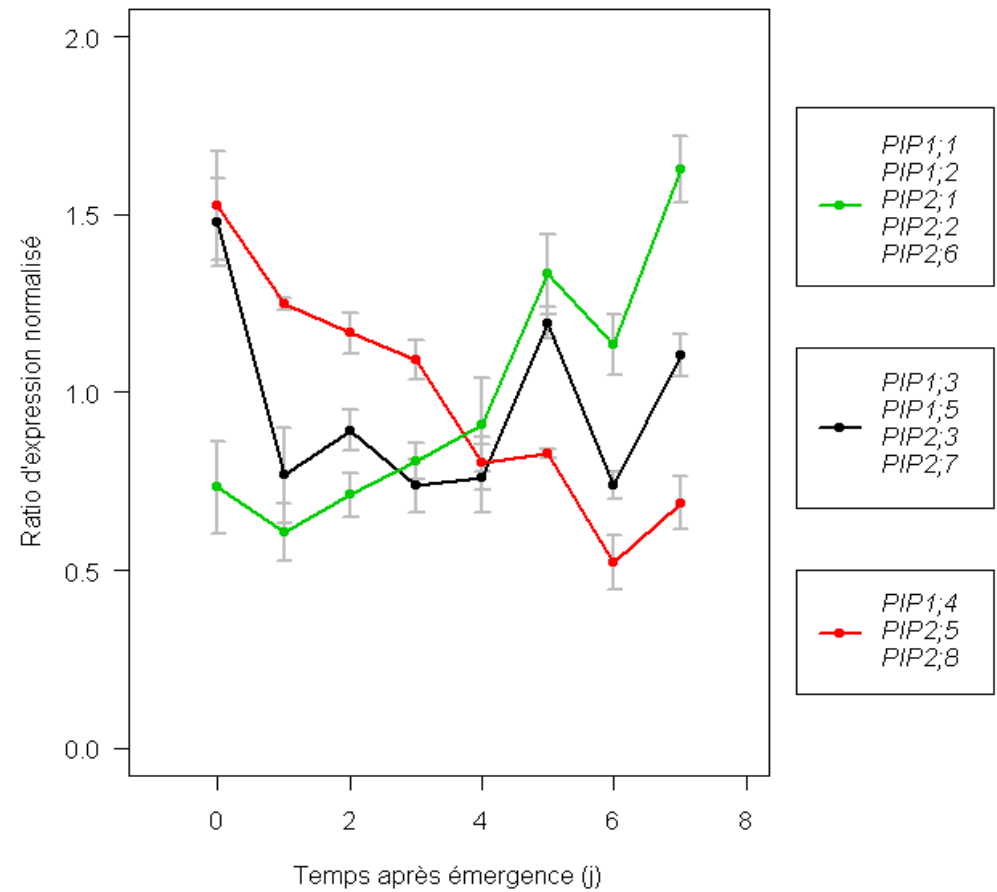

**NIGHT**

# Set of *PIP*s mutants



Col-0(1)



Col-0(13)



PG4 (empty vector)



*PIP2;1*-OE(1)



*PIP2;1*-OE(2)



*pip1;2*(1)



*pip1;2*(2)



*pip2;1*(1)



*pip2;1*(2)



*pip2;6*(1)



*pip2;6*(2)



*pip1;2pip2;1*



*pip1;2pip2;6*



*pip2;1pip2;6*



*pip1;2pip2;1;pip2;6*

# Leaf elongation of *PIP*s mutants

> No obvious response in the KOs, including double and triple mutants

> *PIP2;1-OEs* have a distinct phenotype: early (metabolic) variations are amplified while later (hydraulic) oscillations are attenuated

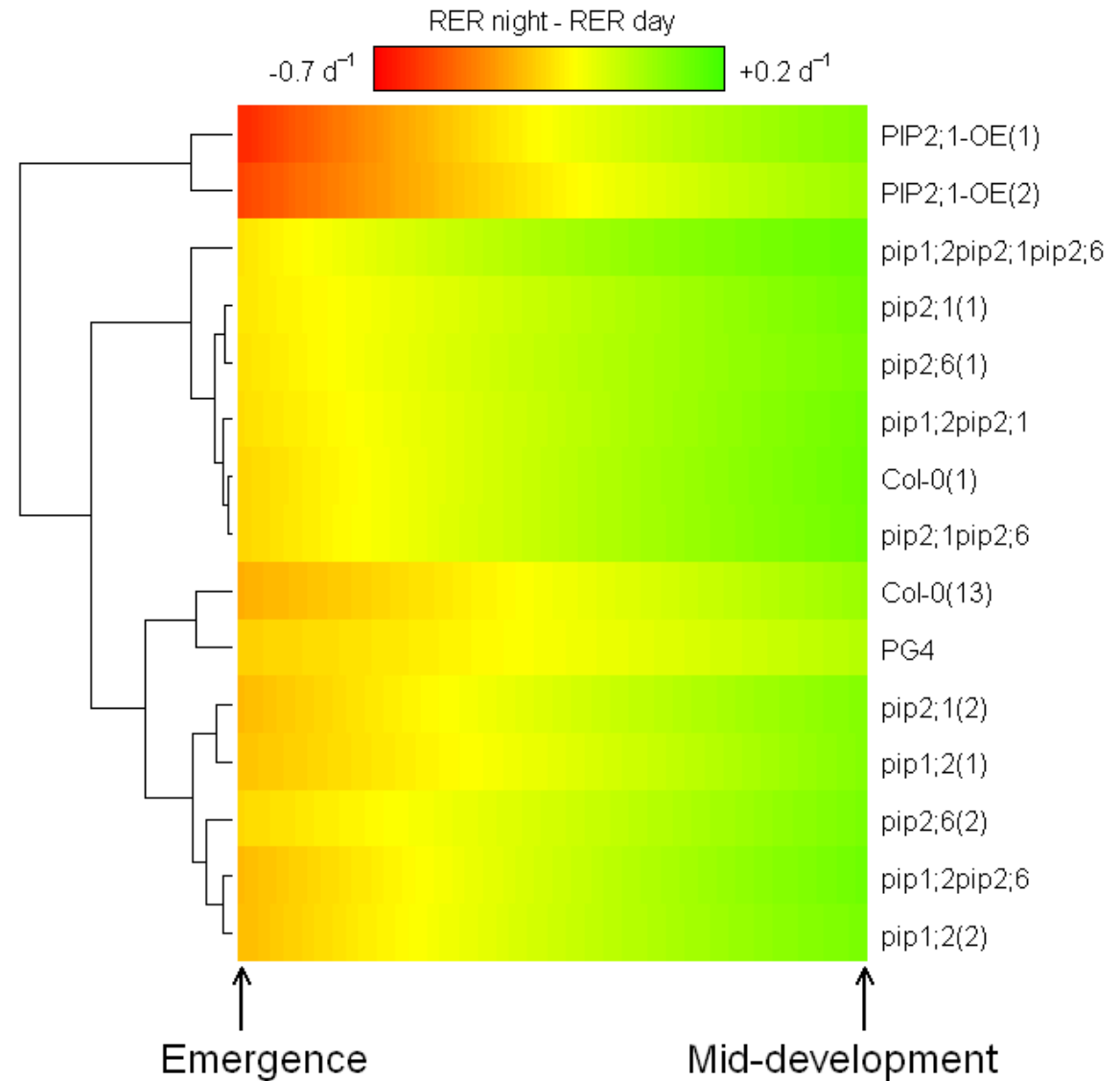

# Leaf growth: establishment of hydraulic control

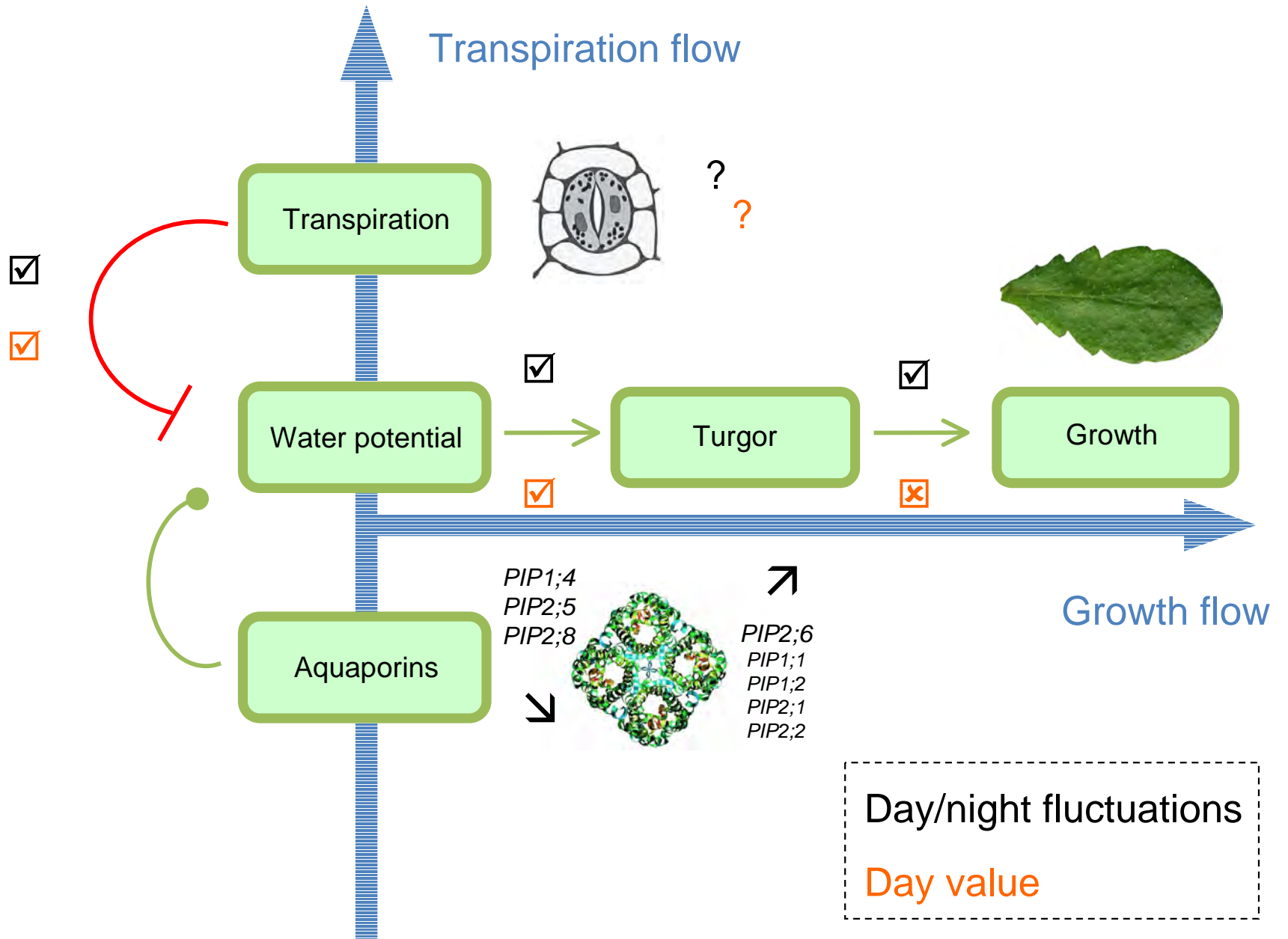

# Leaf growth: establishment of hydraulic control

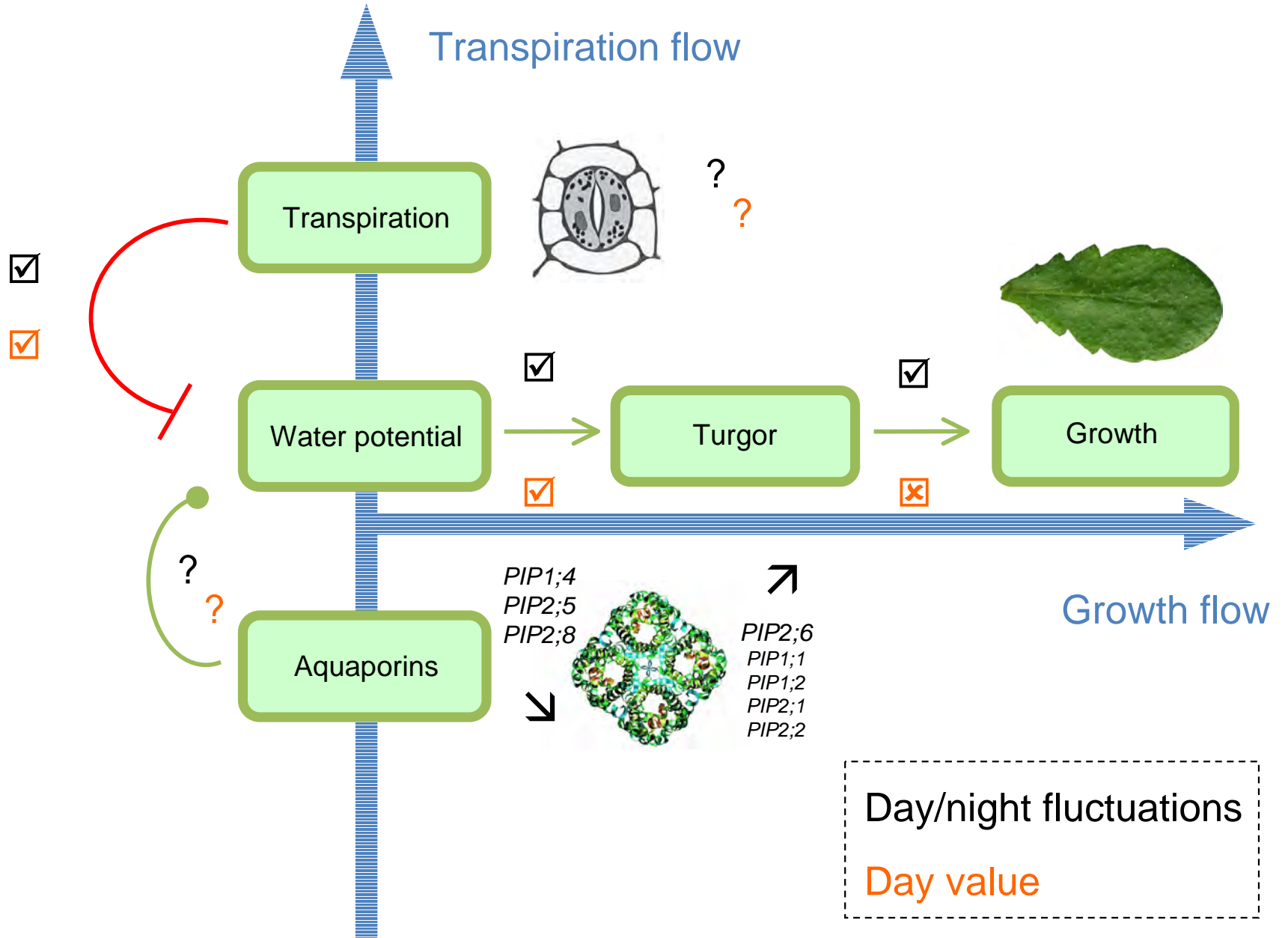

# Leaf growth: establishment of hydraulic control

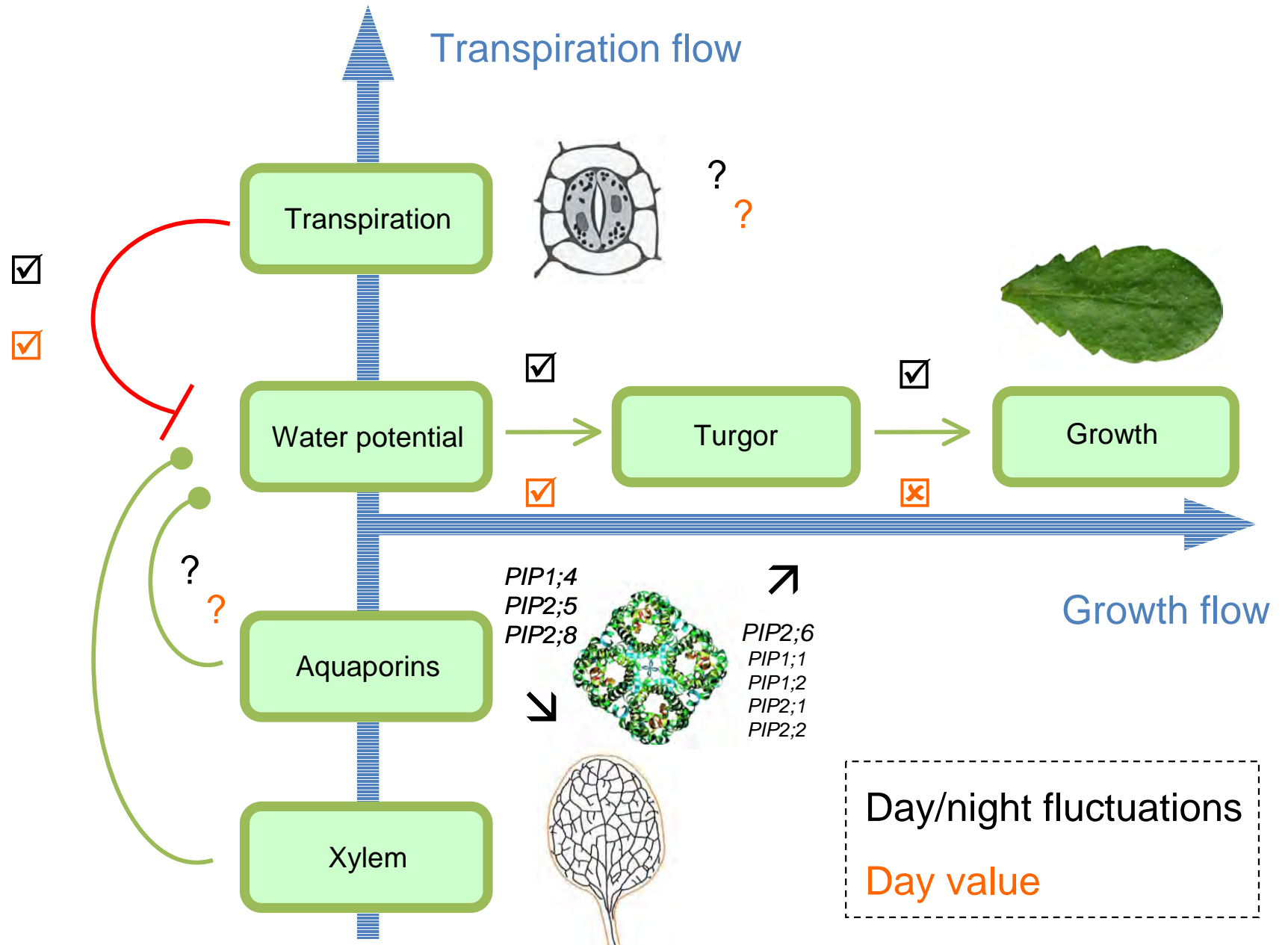

# Xylem network



Plate-forme  
d'Histocytologie  
et d'Imagerie cellulaire Végétale

coll. G. Conéjéro

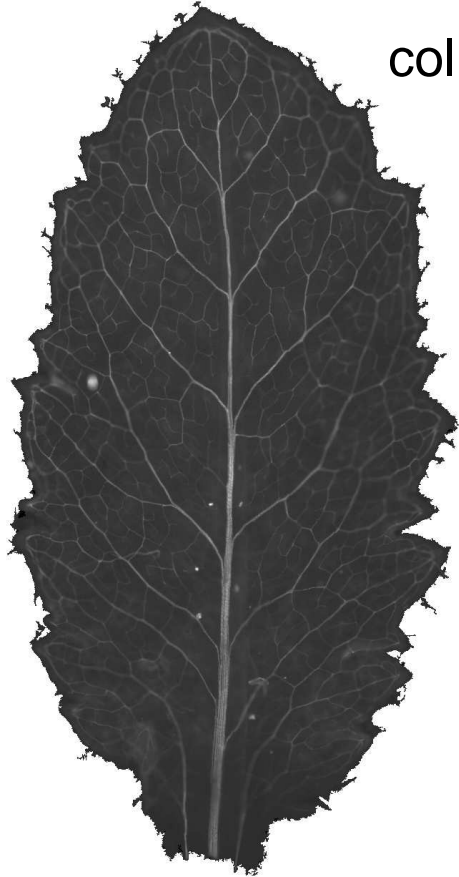

Epifluorescence  
microscopy



# Xylem network



Plate-forme  
d'Histocytologie  
et d'Imagerie cellulaire Végétale

coll. G. Conéjéro

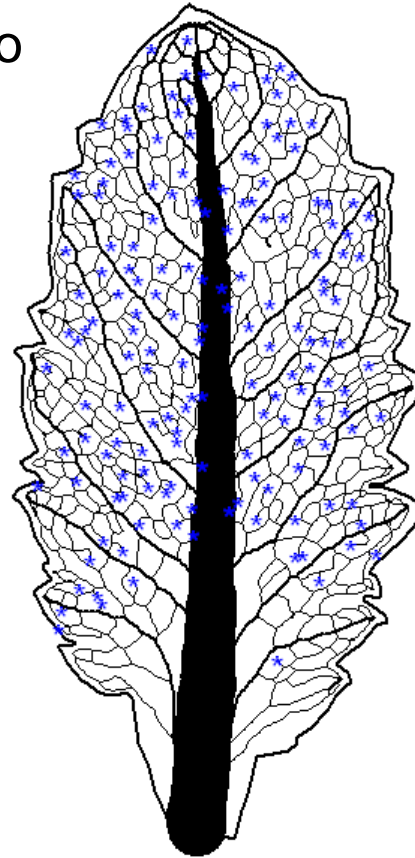
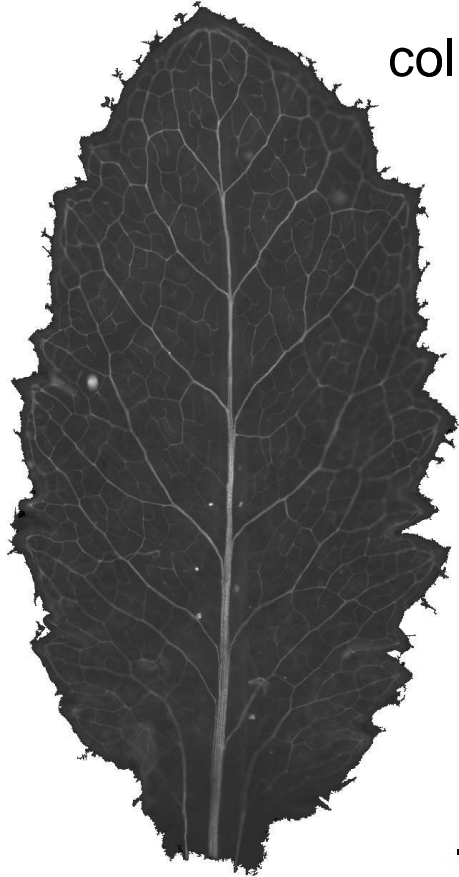

Epifluorescence  
microscopy

Network digitizing

# Xylem network

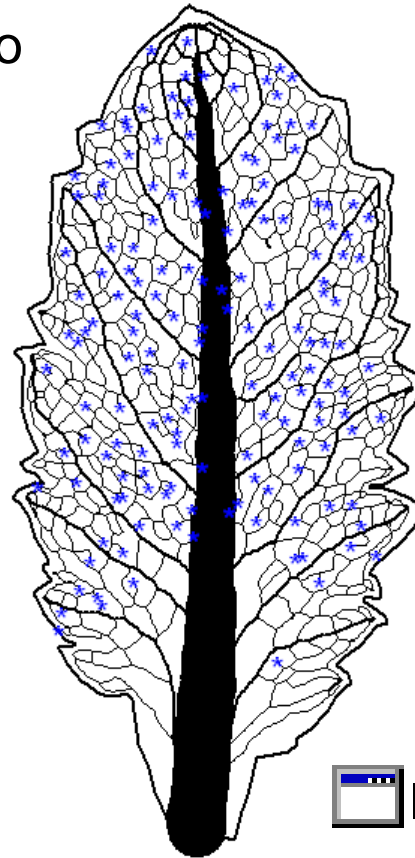
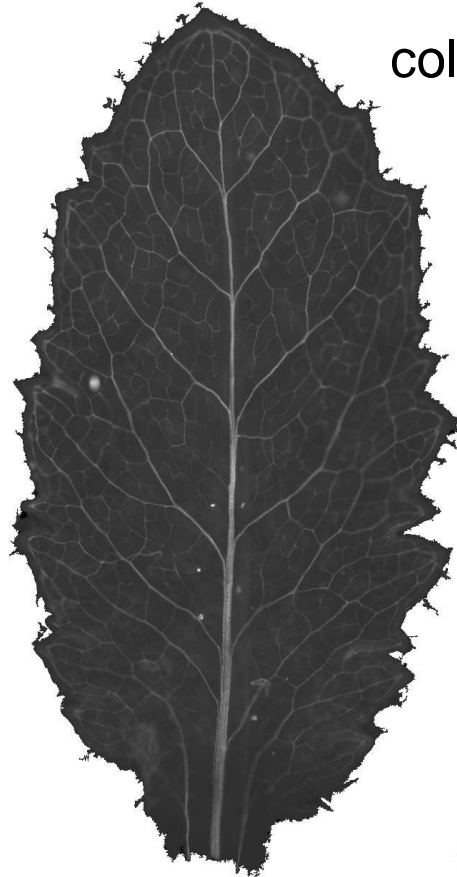

Plate-forme  
d'Histocytologie  
et d'Imagerie cellulaire Végétale



coll. G. Conéjéro

coll. A. Lacoïnte



Hydric!-Reseau.exe

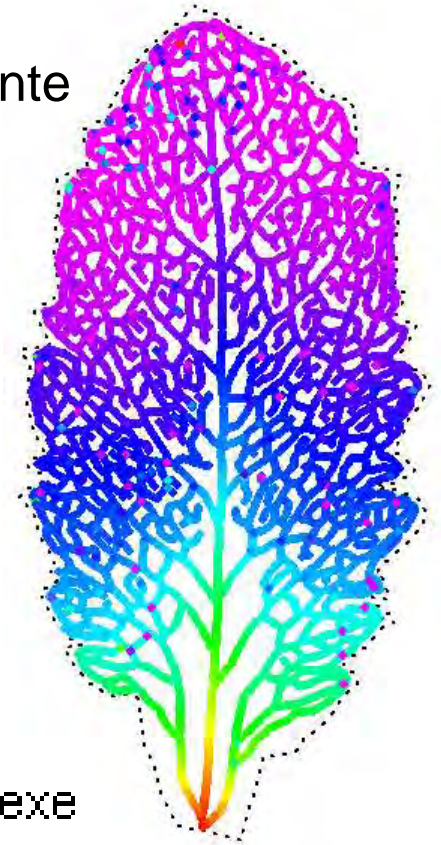

-0.1 MPa  -8.8 MPa

Epifluorescence  
microscopy

Network digitizing

Functional modeling

# Xylem network

 Hydric!-Reseau.exe

- Developed in C++ by A. Lacoïnte to model sieve fluxes within complex architectures (including loops)
- Computes the exact solution of a system of equations following **Ohm's law** and **Kirchoff's node law** given a potential difference or a flux



# Xylem network

## Hydric!-Reseau.exe

- Developed in C++ by A. Lacoïnte to model sieve fluxes within complex architectures (including loops)
- Computes the exact solution of a system of equations following **Ohm's law** and **Kirchoff's node law** given a potential difference or a flux



## Model hypotheses

- Each xylem node is branched in series with a mesophyllic resistance followed by a stoma
- Stomatal and mesophyllic resistances are set very high
- Anatomy: each individual vessel has the same lumen diameter (to be checked in PHIV)

# Xylem network

## Hydric!-Reseau.exe

- Developed in C++ by A. Lacoïnte to model sieve fluxes within complex architectures (including loops)
- Computes the exact solution of a system of equations following **Ohm's law** and **Kirchoff's node law** given a potential difference or a flux



## Model hypotheses

- Each xylem node is branched in series with a mesophyllic resistance followed by a stoma
- Stomatal and mesophyllic resistances are set very high
- Anatomy: each individual vessel has the same lumen diameter (to be checked in PHIV)



# Xylem network

> A double potential gradient establishes spatially in the xylem

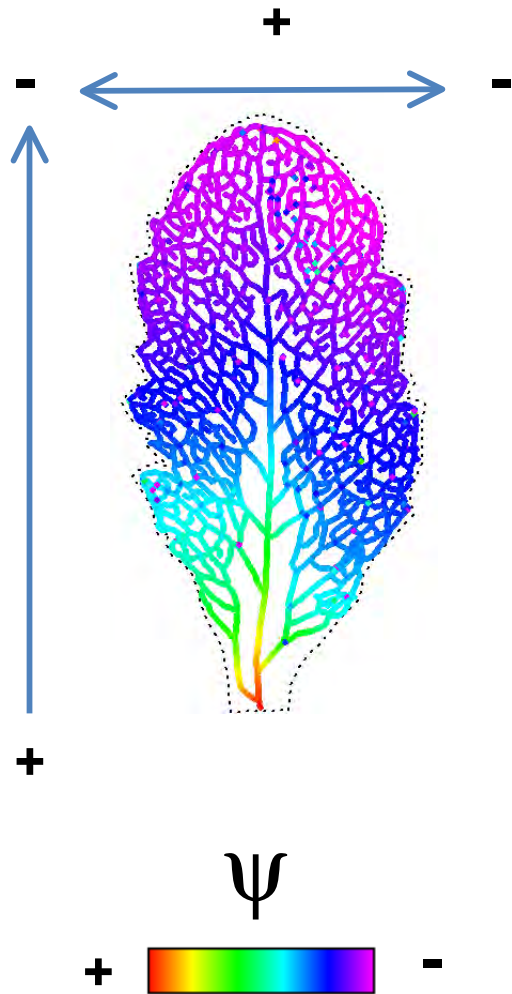

# Xylem network

> A double potential gradient establishes spatially in the xylem

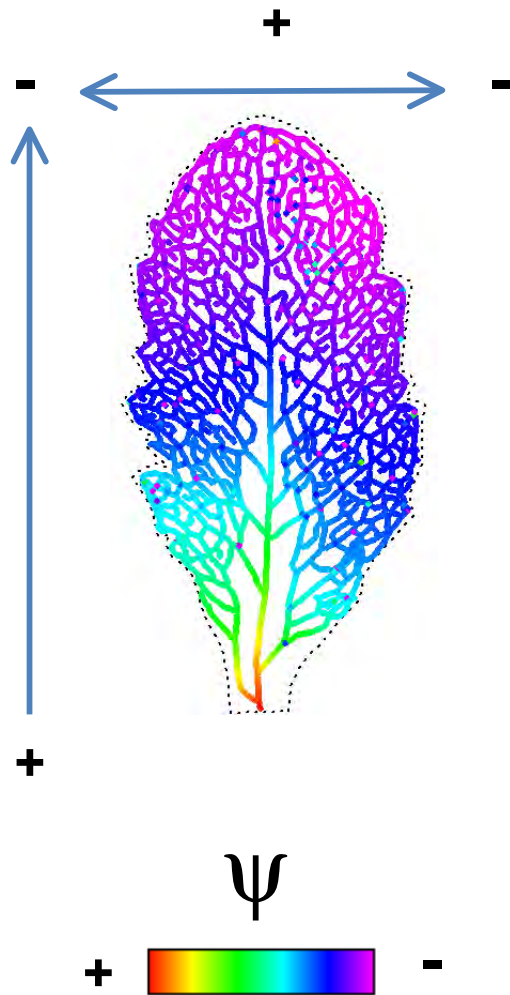

*Plant, Cell and Environment* (2004) 27, 1257–1267

## Hydraulic architecture of leaf blades: where is the main resistance?

H. COCHARD<sup>1</sup>, A. NARDINI<sup>2</sup> & L. COLL<sup>1</sup>

<sup>1</sup>UMR PIAF, Site INRA de Crouel, 63039 Clermont-Ferrand Cedex 2, France and <sup>2</sup>Dipartimento di Biologia, Università di Trieste, Via L. Giorgieri 10, 34127 Trieste, Italy

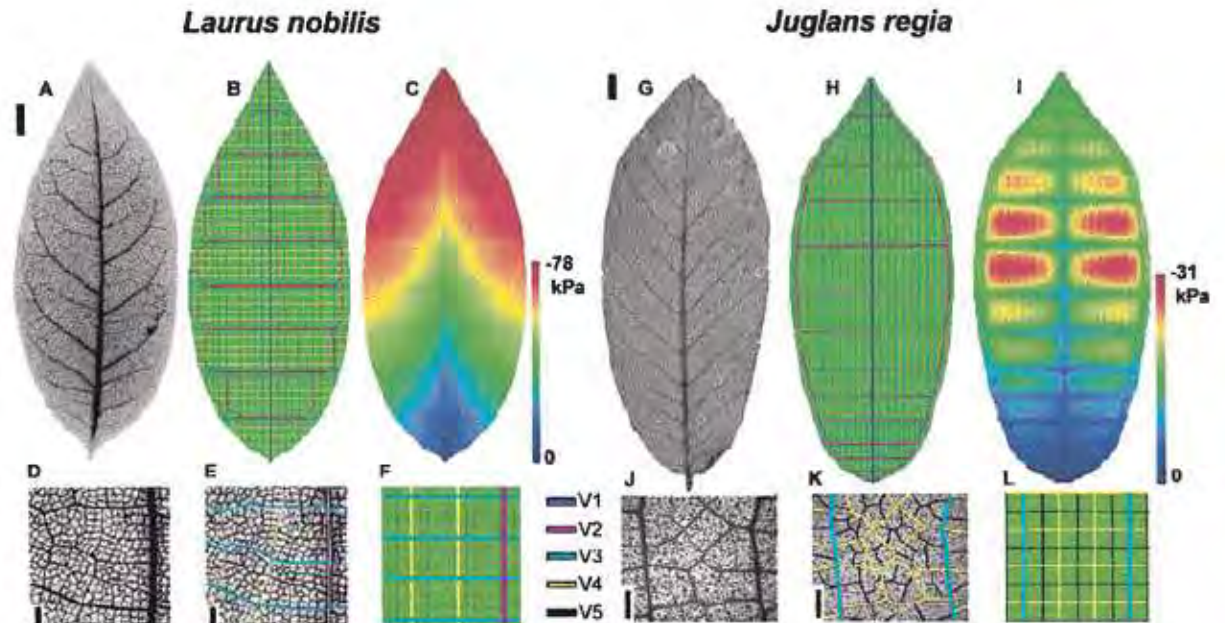

# Xylem network

> This potential gradient is conserved during leaf development

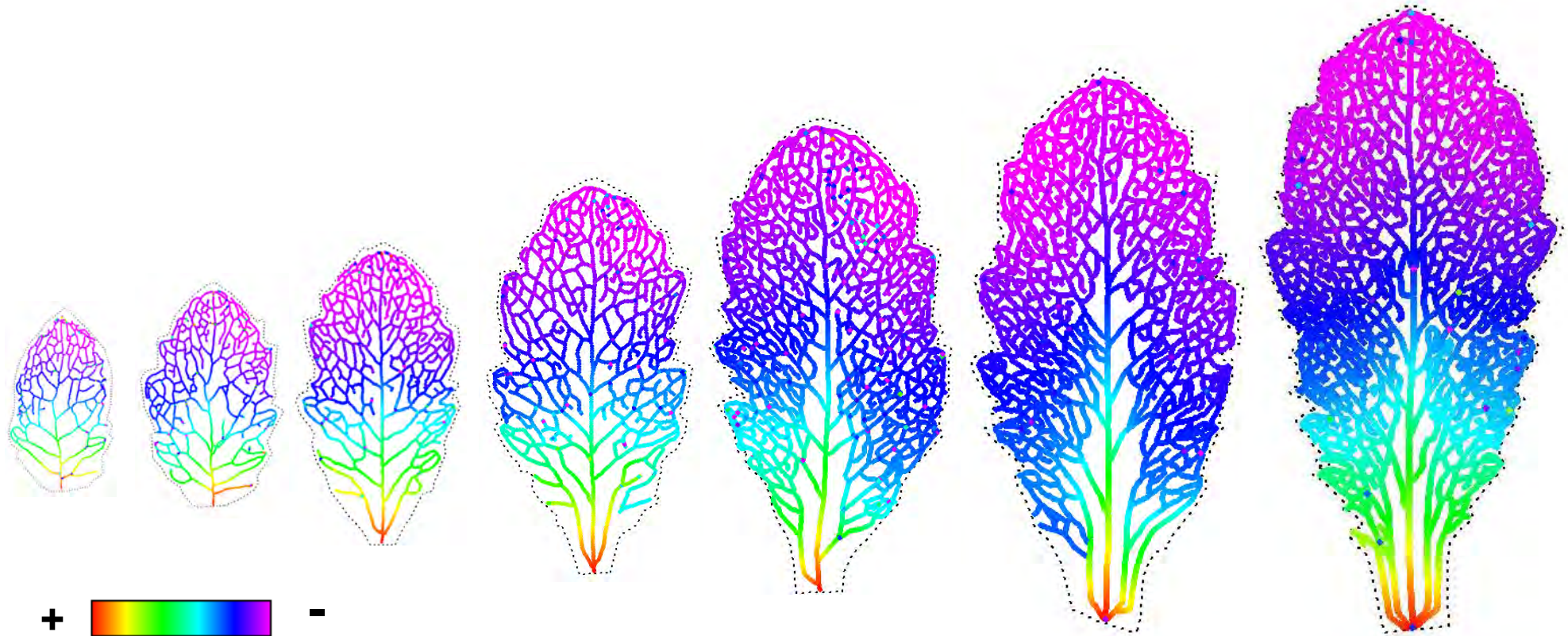

> Absolute values are unrealistic because it would require development-dependent parameterization (stomatal and mesophyll resistance, growth-induced water potential), but it does not influence the xylem conductance values



# Xylem network

> Apparent xylem conductance is computed as

$$K_{\text{xylem}} = \frac{\text{Transpiration}}{\Psi_{\text{petiole}} - \frac{\sum_{i=1}^n \Psi_{\text{node } i}}{n}} \times \frac{1}{\text{Leaf area}}$$

# Xylem network

> Apparent xylem conductance is computed as

$$K_{\text{xylem}} = \frac{\text{Transpiration}}{\Psi_{\text{petiole}} - \frac{\sum_{i=1}^n \Psi_{\text{node } i}}{n}} \times \frac{1}{\text{Leaf area}}$$

> Apparent xylem conductance decreases during leaf development

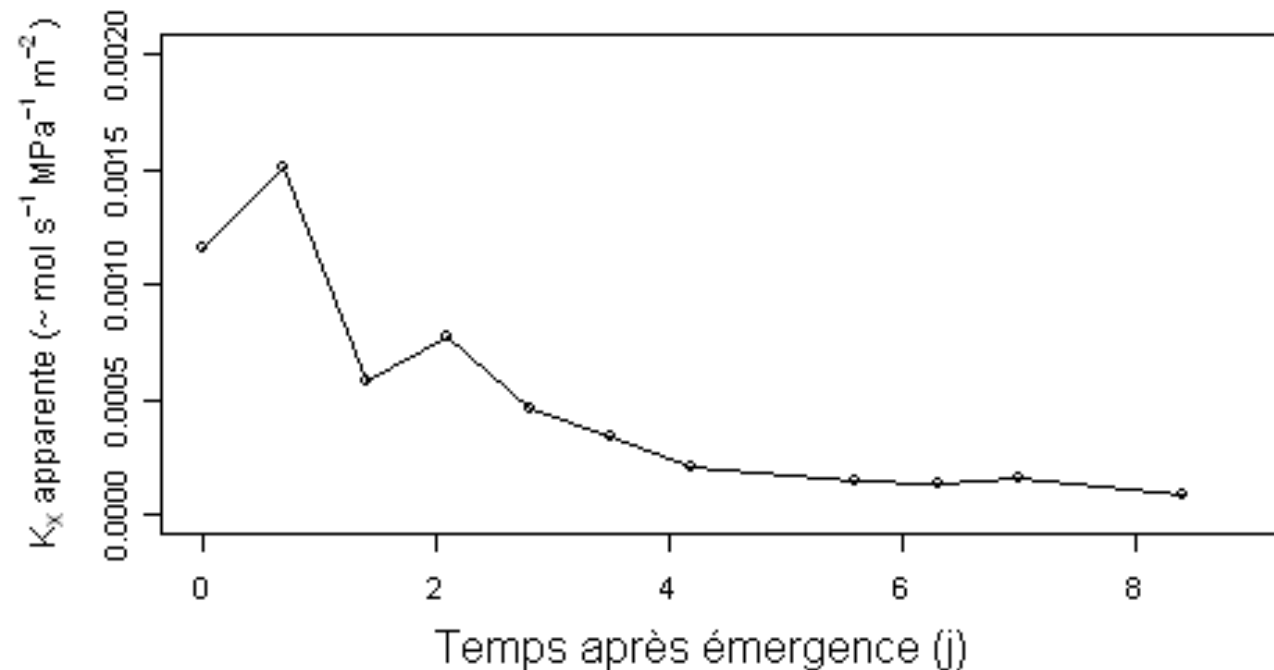

# Xylem network

*Plant, Cell and Environment* (2001) 24, 65–76

## Hydraulic architecture and water flow in growing grass tillers (*Festuca arundinacea* Schreb.)

P. MARTRE,<sup>1</sup> H. COCHARD<sup>2</sup> & J.-L. DURAND<sup>1</sup>

<sup>1</sup>Unité d'Ecophysiologie des Plantes Fourragères, Institut National de la Recherche Agronomique, F-86 600 Lusignan, France, <sup>2</sup>Unité de Physiologie Intégrée des Arbres Fruitiers, Institut National de la Recherche Agronomique, F-63 039 Clermont-Ferrand, France

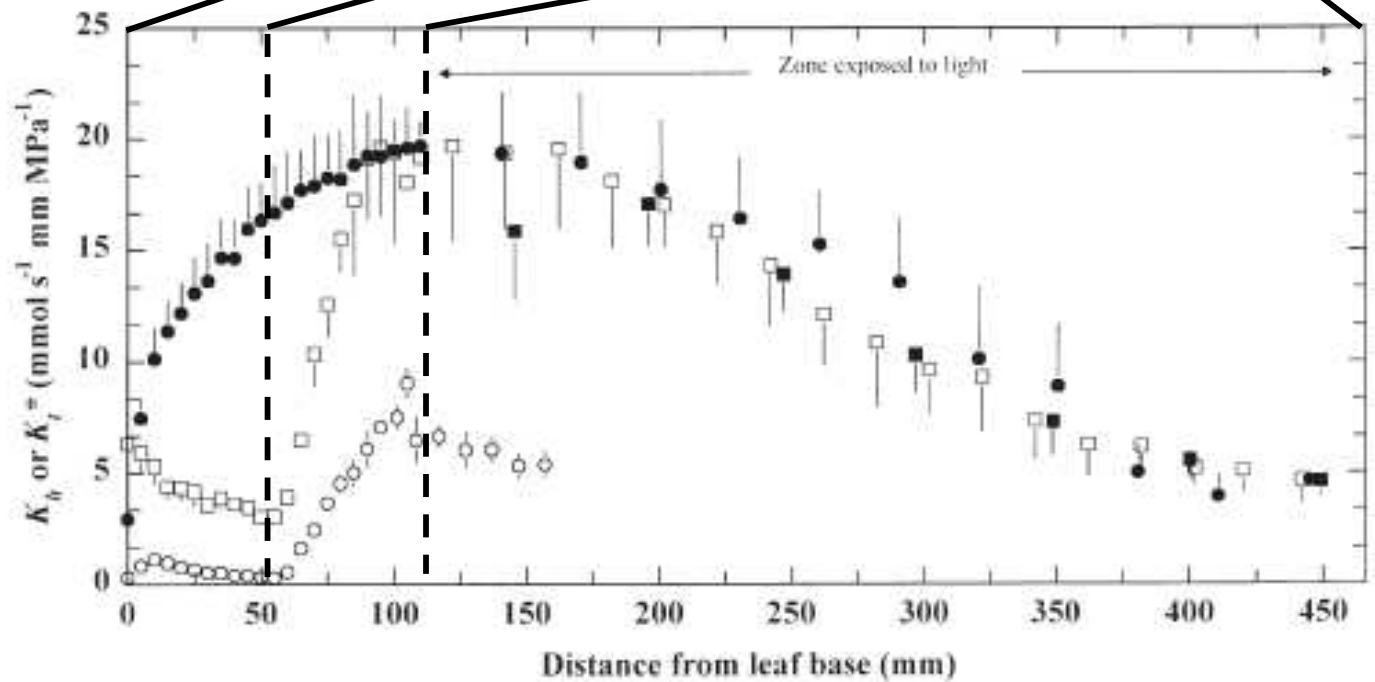
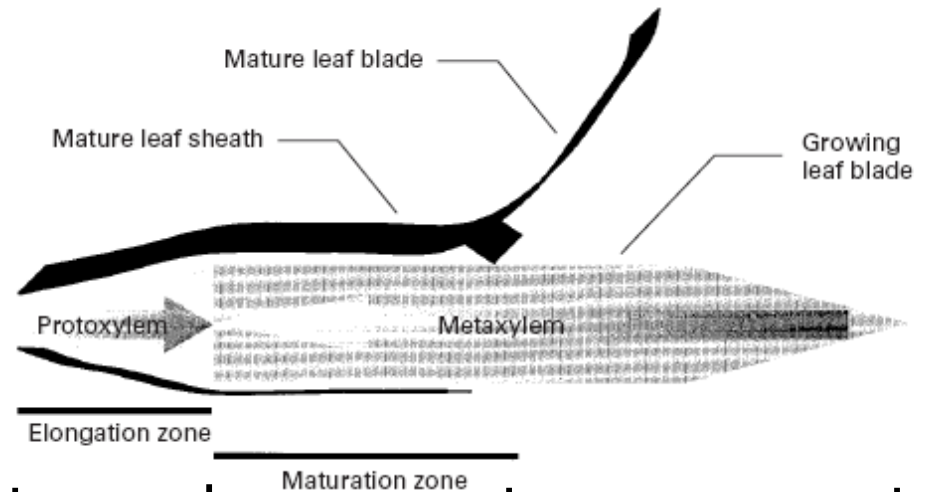

# Leaf growth: establishment of hydraulic control

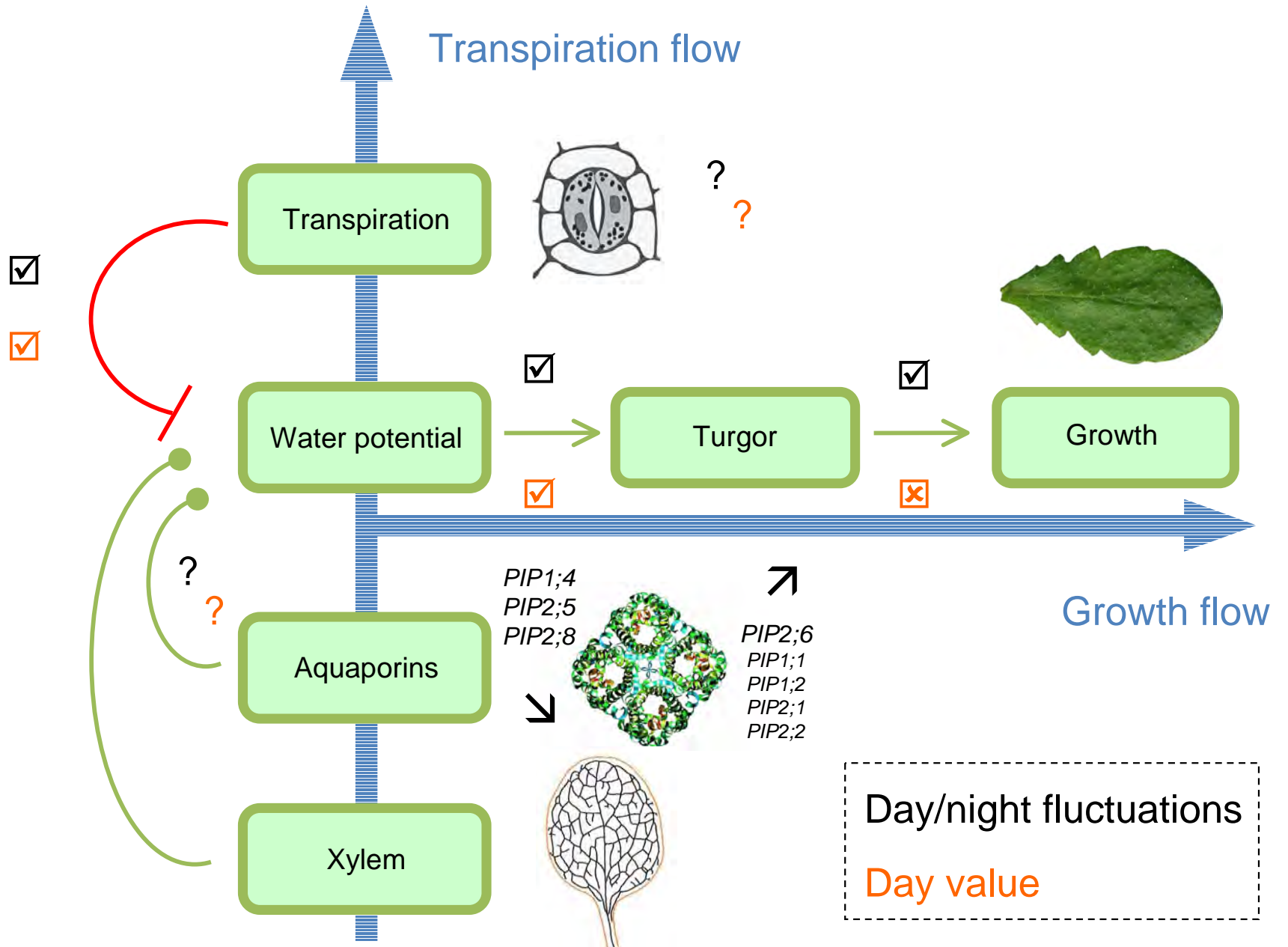

# Leaf growth: establishment of hydraulic control

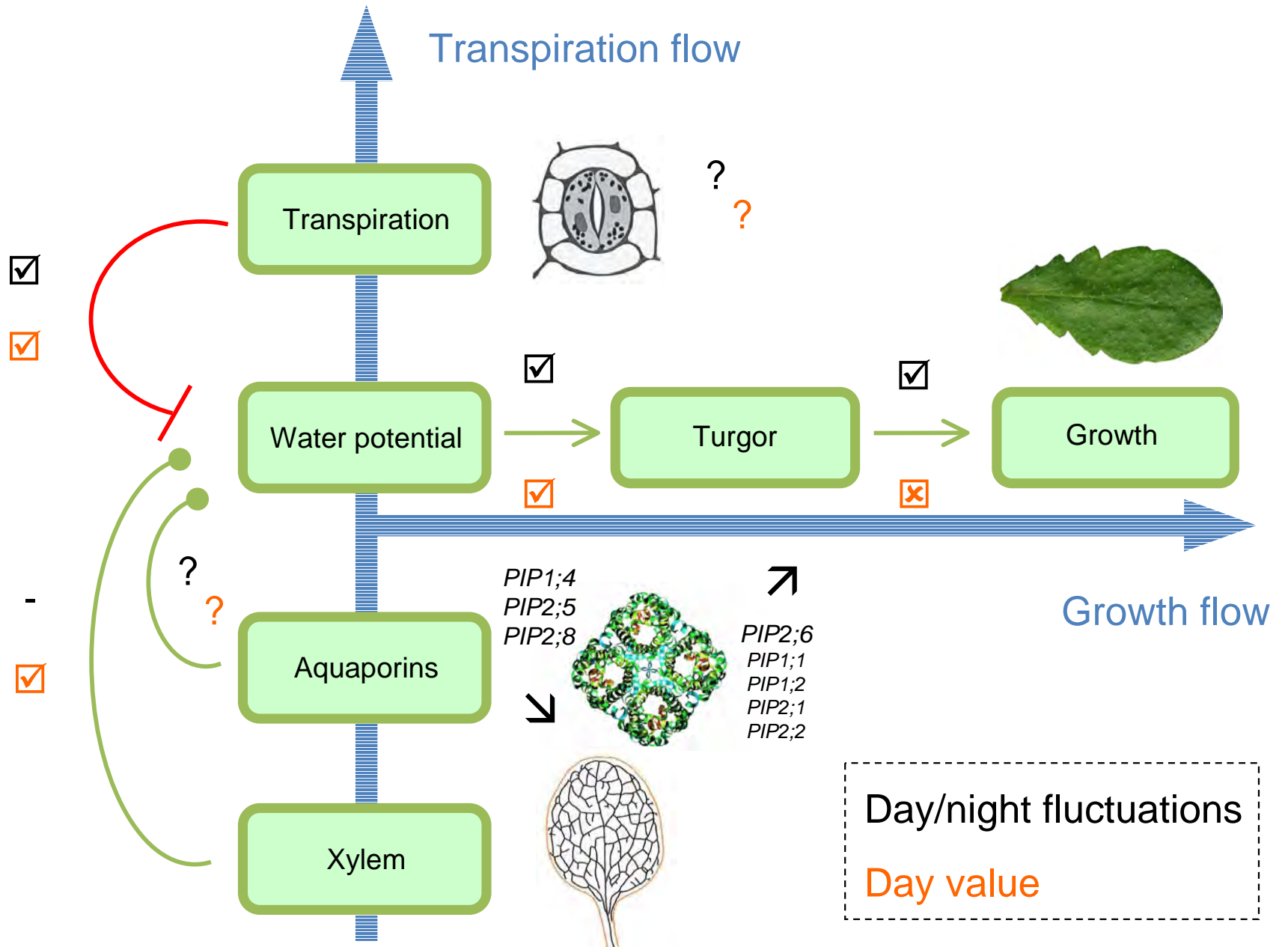



## Conclusion

- > **Hydraulics drives diurnal depressions of growth** as evidenced by turgor, water potentials, and transpiration fluctuations between day and night
- > **Establishment of diurnal hydraulic control** during leaf development in *Arabidopsis* is likely to result of both
  - (i) an **absence of transpiration fluctuation** in the early stages
  - (ii) a progressive **limitation of water supply by xylem** (and maybe aquaporins)
- > The reason why **transpiration in the early stages** is higher than in the later stages and not lower at night remains elusive

**Thanks for attention**

