



HAL
open science

Improved MEMS-in-TEM setup for high sensitivity thermal characterization of nanowire using a new TEM cryo-holder

Laurent Jalabert, G. Valet, A. Chorosz, D. Guo, R. Kometani, Hervé Guillou, T. Sato, Sebastian Volz, Hiroyuki Fujita

► To cite this version:

Laurent Jalabert, G. Valet, A. Chorosz, D. Guo, R. Kometani, et al.. Improved MEMS-in-TEM setup for high sensitivity thermal characterization of nanowire using a new TEM cryo-holder. 2013 Transducers & Eurosensors XXVII: The 17th International Conference on Solid-State Sensors, Actuators and Microsystems (TRANSDUCERS & EUROSENSORS XXVII), Mar 2014, Barcelone, Spain. pp.1839, 10.1109/Transducers.2013.6627148 . hal-00963659

HAL Id: hal-00963659

<https://hal.science/hal-00963659>

Submitted on 24 Mar 2014

HAL is a multi-disciplinary open access archive for the deposit and dissemination of scientific research documents, whether they are published or not. The documents may come from teaching and research institutions in France or abroad, or from public or private research centers.

L'archive ouverte pluridisciplinaire **HAL**, est destinée au dépôt et à la diffusion de documents scientifiques de niveau recherche, publiés ou non, émanant des établissements d'enseignement et de recherche français ou étrangers, des laboratoires publics ou privés.

IMPROVED MEMS-IN-TEM SETUP FOR HIGH SENSITIVITY THERMAL CHARACTERIZATION OF NANOWIRE USING A NEW TEM CRYO-HOLDER

L. Jalabert¹, G. Valet², A. Chorosz³, D. Guo⁴, R. Kometani⁴, H. Guillou¹, T. Sato², S. Volz⁵, H. Fujita²

¹LIMMS-CNRS/IIS University of Tokyo, JAPAN

²Institute of Industrial Science, University of Tokyo, JAPAN

³ECAM, Lyon, FRANCE

⁴Graduate School of Engineering, University of Tokyo, JAPAN

⁵CNRS, LEM2C, Ecole Centrale Paris, FRANCE

ABSTRACT

Thermal conductivity of diamond-like-carbon nanowire is investigated by combining MEMS in TEM (transmission electron microscope) with a new cryogenic TEM holder allowing *in-situ* electrical measurements from 90K to 380K. A suspended DLC nanowire of 80nm in diameter and 10mic in length was locally grown by FIB-CVD in between an integrated micro-heater and a temperature sensor. Combined with a special Wheatstone bridge configuration, we show drastic improvement of temperature detection on the sensor and estimate the thermal conductance of the DLC nanowire at low temperature *in-situ* in TEM.

INTRODUCTION

More than 60% of the overall heat produced in the world is wasted. Heat to electricity conversion and heat dissipation managements are one of main challenges for the future. Interesting solutions for enhancing heat dissipation have been recently proposed, especially focusing on diamond-like-carbon (DLC) [1] because of its high electrical and thermal conductivities. It is still very challenging to fabricate and/or report single nanostructure between suspended heating/sensing platforms, and usually those fragile nanostructures are in the range of a few microns in length.

Recently, we explored a Lab-in-a-TEM method both for *in-situ* in TEM fabrication and characterization of nanojunction with length and diameter <100nm with real-time video monitoring [2]. In this previous work, we observed a ballistic phonon transport above room temperature that could be a suitable way to dissipate efficiently the heat in confined areas. The experimental setup was based on a MEMS device mounted in a TEM holder, with an integrated 1D actuator, sensor and heater. The nanojunction was made *in-situ* by cold welding and elongation process. As the thermal conductance depends on the geometry of the nanostructure and indeed of the phonon mean free path, it is important to perform low temperature measurement while observing in real time with the atomic resolution.

Here, we present 3 major improvements for measuring the thermal properties of nanostructures *in-situ* in UHV-TEM:

- a) New TEM cryogenic holder with electrical connections for mounting MEMS device, and operating from ~90K up to 380K in UHV.
- b) Cr/Pt integrated micro resistors on MEMS.
- c) Homemade-Wheatstone bridge connected to the sensor resistance (in-TEM) allowing temperature resolution below 10mK.

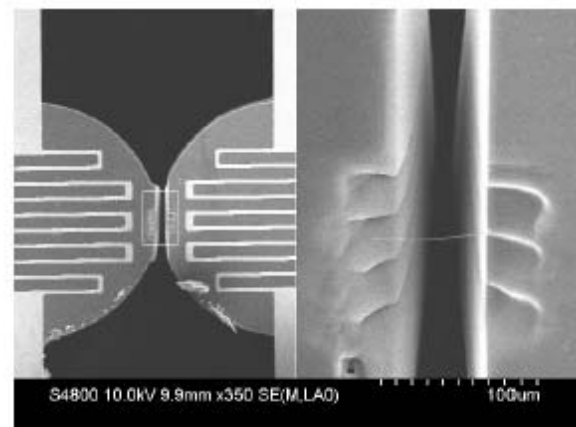
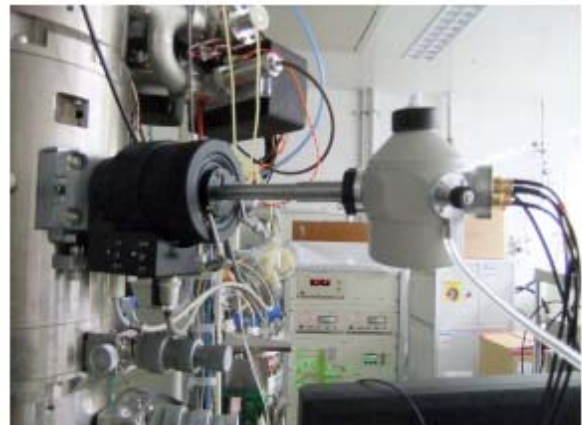

Figure 1: **Right:** Cryo-holder for MEMS in TEM. **Left:** SEM image of a suspended DLC ($L=10\mu\text{m}$, $\phi=80\text{nm}$) made by FIB-CVD between two Cr/Pt based micro-heater and temperature sensor. Right side: zoom x8. Bar scale is related to the left side image.

FABRICATION AND SETUP

The MEMS device is based on the symmetric suspended resistors, both made of Cr/Pt, one being used as a local micro-heater closed to the nanostructure to be studied, and the other one as a temperature sensor. The nominal heater resistance R_h and sensor R_s values are typically around 850Ω at room temperature (RT). The fabrication is based on a lift-off process followed by similar process flow reported elsewhere [2].

A suspended DLC nanowire of 10mic in length and 80nm in diameter was fabricated in between the MEMS micro resistances (Fig.1) by focused-ion-beam chemical vapor deposition (SII NanoTechnology SMI3050) [3-7]. Single nanostructures are obtained by reacting phenanthrene gas ($C_{14}H_{10}$) with the gallium beam (30kV, beam current $\sim 1\text{pA}$) closed to the region of interest. The induced growth of nanowire, here DLC, is controlled by the irradiation area and irradiation time of FIB Ga beam at 5×10^{-5} Pa. We used program on computer to control the scanning speed (90 nm/s) and the scan position of FIB, via a wave function generator (NF Wave Factory WF1966). In this experiment, the deposition started and ended from the top of the two facing silicon tips.

TEM Cryo-holder

A new TEM cryo-holder was co-designed with Hitachi and Gatan for Hitachi HF2000 UHV-TEM operating at 5×10^{-8} Pa. The head is designed for mounting a 4mmx5mm MEMS device. Cooling is standardly operating by a cold finger with liquid nitrogen. Heating capability is performed via an embedded resistor connected to a temperature controller (Gatan Model 900). Platinum temperature sensor is located on the head at about 3cm away from the MEMS device. The holder temperature is feedback controlled (RS232) with a sampling rate of 1sec. Five metallic pins are designed to directly contact the pads of the MEMS device, avoiding wire bonding. Even the contact force cannot be controlled the pins are mounted on thermally insulated flexible arms that are gently bent when screwing the capping part.

Electrical standard configuration

In the standard measurement case, the micro-resistances R_s and R_h are connected to two independent SMU of an Agilent B1500 semiconductor parameter analyzer. SMA-triax connectors (common and guard connected) and triax cables connect the cryo-holder to the B1500. For

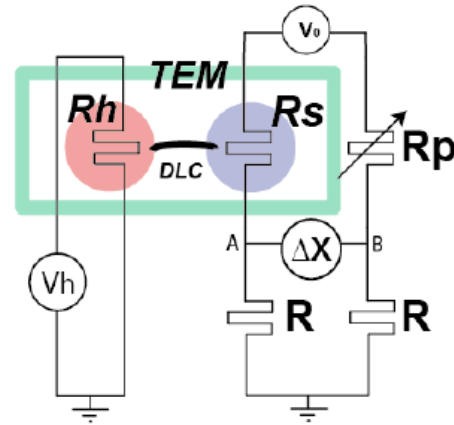

Figure 2: Standard configuration on the heater and AC Wheatstone bridge configuration on the sensor. Constant voltage cycles are supplied on the resistance R_h for 10sec every 100sec

in-situ $R(T)$ calibrations, low constant voltages of typically 50mV or 100mV are supplied on each resistor in order to avoid Joule heating, while measuring simultaneously the currents. For heat transfer measurement, Joule heating short sequences of a few volts are automated using a Labview interface.

Wheatstone bridge configuration

AC source V_0 (1kHz, 0.1V) is powered by a lock-in amplifier (SR830), which also measures the bridge differential amplitude ΔX . Variable resistance R_p (IET HARS) is initially adjusted to balance the bridge ΔX typically a few μV or below. The two fixed Z-foil resistors (R) of $1\text{k}\Omega$ each (Vishay VHP203) are chosen for their low TCR at ambient temperature (0.01 ppm) in order to prevent artifacts due to room temperature variations (around 21°C).

In-situ in TEM temperature calibration of MEMS resistors

The corresponding variations of the heater current and lock-in amplitude of the sensor are presented on Figure 3. The linear and non-linear temperature coefficients (TCR) of the Cr/Pt micro-resistances were $1.7 \times 10^{-3} \text{ K}^{-1}$ and $-5 \times 10^{-6} \text{ K}^{-2}$ respectively.

RESULTS AND DISCUSSIONS

The Wheatstone bridge was connected to the sensor. The selected sensitivity range was fixed to 1mV. Between 95.66K and 95.76K the bridge (sensor) shows better accuracy than the standard configuration (heater) and can measure a variation of $17 \mu\text{V}/100\text{mK}$ (Fig.4, top).

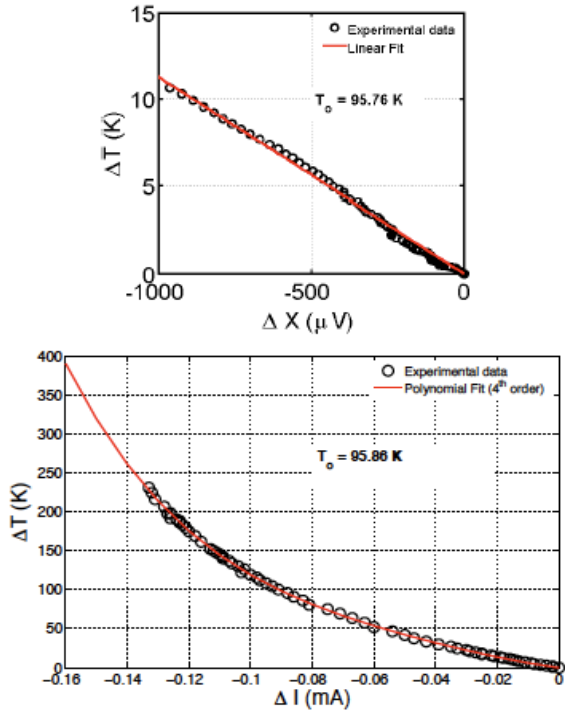

Figure 3: **Top**: Sensor calibration of the Cr/Pt sensor using the TEM cryo-holder from a nominal $T_0=95K$ up to 105K. ΔX represents the variation of the amplitude on the lock-in amplifier (Wheatstone bridge with $V_0=0.1V$). **Bottom**: Heater calibration of the Cr/Pt heater from $T=95K$ up to 240K.

In those (worst) conditions the Wheatstone bridge sensitivity is about $6mK/\mu V$. For fast temperature changes (Fig.4, bottom), the standard measurement ($1\mu A$ resolution) sensitivity is closed to $300mK/\mu A$. The Wheatstone configuration improves the sensitivity by a factor 50 compared to standard method.

At 121.55K, the heating current was stopped (Gatan 900) and we observed the natural cooling down. We noticed that the temperature decreases slower on the MEMS than the holder sensor.

Heat transfer

Those sensitivity improvements are of main concern for nanoscale heat transfer experiments performed in-situ in TEM. By supplying constant voltage cycles for 10sec/100sec (ON/OFF states) on the MEMS heater, Joule heating induces a temperature rise on the MEMS sensor consecutive to heat transferred through the nanowire.

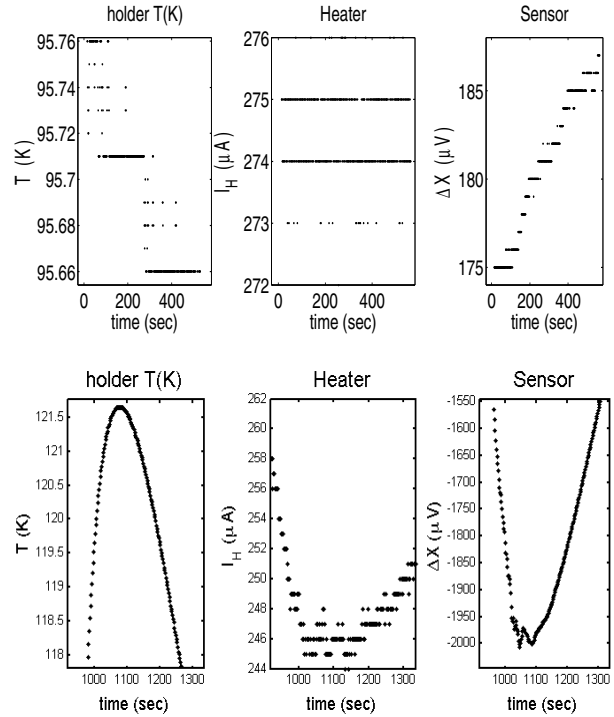

Figure 4. Comparison of Standard (heater at $V_h=100mV$) and AC Wheatstone bridge (sensor) configurations on a plateau at $T=95.71K$ (top) and for a heating/cooling up to 121.5K (bottom).

Monitoring R_s changes has been conducted either using standard method $I(\text{time} @ V=\text{cste})$ on both the MEMS heater and sensor resistors, or connecting the sensor to the AC Wheatstone bridge.

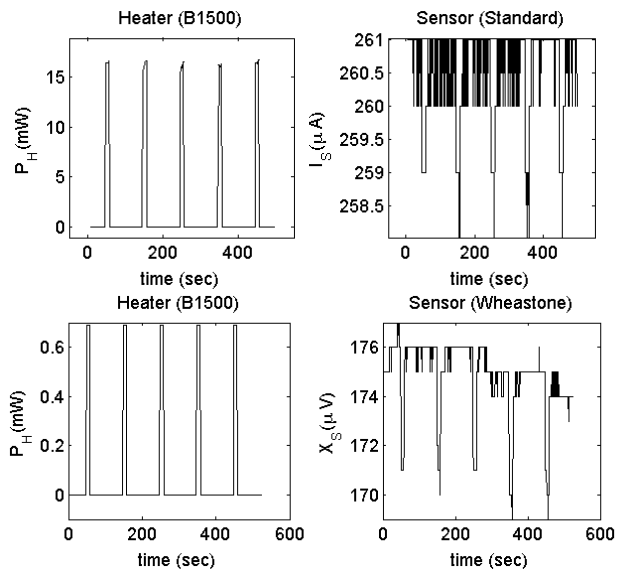

Figure 5. Injected heater power and sensor detection limits for the standard (top; $V_h=2.5V$) and Wheatstone bridge (bottom; $V_h=0.5V$) configurations. ($T_0=98K$).

Here, due to the MEMS dimensions (4mm x 5mm) and the confinement on the head of the TEM holder

(that is far different than conventional cryostat configuration), it is mandatory to avoid heat transfer artifacts coming from other part of the device than the nanowire. Therefore heat confinement on the heater part implies both a MEMS design with long suspended beams (800 μm in length) and moderate injected power on the heater, thence high sensitive sensing capabilities.

The high sensitivity improvement with the Wheatstone configuration allows measuring a few 10mK temperature variations on the sensor (Fig.5-bottom) while reducing the heater injected power by a factor 25 compared to standard configuration (Fig.5 – top).

The thermal conductance G of the DLC nanowire is presented on Fig.6 (right side) for the standard configuration at $T_0=110\text{K}$. The variations of R_h and R_s have been converted to ΔT_h and ΔT_s using the corresponding experimental data obtained from a calibration performed hereafter the Joule heating sequences ($V_h=0.5\text{V}$ up to 4V). G is given by $G = G_0 \frac{\Delta T_s}{\Delta T_h - \Delta T_s}$, with an estimated G_0 calculated from finite element methods with considering the geometry of the MEMS and its suspended beams [2].

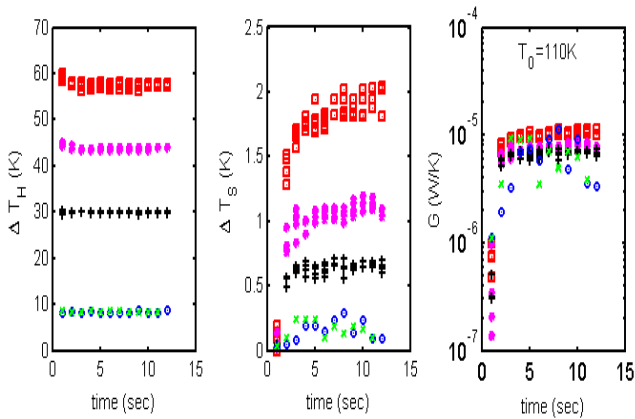

Figure 6. Heater (right) and sensor (center) temperature variations during heating/cooling sequences, and the calculated thermal conductance of the DLC nanowire (diameter 80nm, length 10 μm).

Our first measurement of the thermal conductance of the DLC nanowire gives a value around 10 $\mu\text{W/K}$ at 110K for high injected power, and we notice a decrease by a factor 2 at low injected power. Complementary experiments with using the Wheatstone configuration are on going.

CONCLUSIONS

In this paper, we focused on the new TEM cryo-holder and MEMS micro-resistor performances for in-situ in TEM heat transfer measurements.

Compared to our standard setup, a AC Wheatstone bridge configuration on the MEMS sensing resistance improve drastically the temperature sensitivity by a factor 50 compared to our previous setup. Such a low temperature TEM holder adds more functionality for exploring nanosciences since it can combine electrical, mechanical and thermal stimuli/sensing to real-time observation in TEM. The thermal conductance measurement of a single DLC nanowire at 110K in-situ in Ultra-High Vacuum TEM was as high as $\sim 10\mu\text{W/K}$, but need to be confirmed by complementary experiments at different nominal temperature.

REFERENCES:

- [1] Wu Li, N. Mingo, L. Lindsay, D. A. Broido, D. A. Stewart, and N. A. Katcho, "Thermal conductivity of diamond nanowires from first principles", *Phys. Rev. B*, 85, 195436 (2012).
- [2] L. Jalabert, T. Sato, T. Ishida, H. Fujita, Y. Chalopin, S. Volz, "Ballistic thermal conductance of a Lab-in-a-TEM made Si nanojunction", *Nano Lett.* (2012), 12, 5213–521.
- [3] Shinji Matsui, "Focused-ion-beam deposition for 3-D nanostructure fabrication", *Nuclear Instruments and Methods in Physics Research B* 257 (2007) 758–764.
- [4] S. Matsui, T. kaito, J. Fujita, M. Komuro, K. kanda, and Y. Haruyama: *J. Vac. Sci. Technol. B* 18 (2000) 3181.
- [5] T. Morita, R. Kometani, K. Watanabe, K. Kanda, Y. Haruyama, T. Hoshino, K. Kondo, T. Kaito, T. Ichihashi, J. Fujita, M. Ishida, Y. Ochiai, T. Tajima and S. Matsui: *J. Vac. Sci. Technol. B* 21 (2003) 2737-2741.
- [6] R. Kometani, S. Ishihara, T. Kaito, and S. Matsui: *Appl. Phys. Express* 1 (2008) 055001.
- [7] D. Guo, R. Kometani, S. Warisawa and S. Ishihara: *Jpn. J. Appl. Phys.* 51 (2012) 065001.

CONTACT

* L. Jalabert, jalabert@iis.u-tokyo.ac.jp