



**HAL**  
open science

## Observer-based fault tolerant control design for a class of LPV descriptor systems

Mickael Rodrigues, Hamdi Habib, Naceur Benhadj Braiek, Didier Theilliol

### ► To cite this version:

Mickael Rodrigues, Hamdi Habib, Naceur Benhadj Braiek, Didier Theilliol. Observer-based fault tolerant control design for a class of LPV descriptor systems. *Journal of The Franklin Institute*, 2014, 351 (6), pp.3104-3125. <10.1016/j.jfranklin.2014.02.016>. <hal-00959769>

**HAL Id: hal-00959769**

**<https://hal.science/hal-00959769v1>**

Submitted on 17 Mar 2014

HAL is a multi-disciplinary open access archive for the deposit and dissemination of scientific research documents, whether they are published or not. The documents may come from teaching and research institutions in France or abroad, or from public or private research centers.

L'archive ouverte pluridisciplinaire HAL, est destinée au dépôt et à la diffusion de documents scientifiques de niveau recherche, publiés ou non, émanant des établissements d'enseignement et de recherche français ou étrangers, des laboratoires publics ou privés.



HAL Authorization

# Observer-based Fault Tolerant Control Design for a Class of LPV Descriptor Systems

Mickael Rodrigues<sup>a</sup>, Habib Hamdi<sup>b</sup>, Naceur BenHadj Braiek<sup>b</sup>, Didier Theilliol<sup>c</sup>

<sup>a</sup>Laboratoire d'Automatique et Génie des Procédés, Université de Lyon, Lyon, F-69003, France; Université Lyon 1, CNRS UMR 5007, Villeurbanne, F-69622, France (e-mail: mickael.rodrigues@univ-lyon1.fr).

<sup>b</sup>Laboratory for Advanced Systems at the Tunisia Polytechnic School, University of Carthage, Tunisia; (e-mail: hammdihabib@yahoo.fr)

<sup>c</sup>Centre de Recherche en Automatique de Nancy, Université de Lorraine, CNRS UMR 7039, France (e-mail {didier.theilliol}@univ-lorraine.fr).

---

## Abstract

This paper presents a new Fault Tolerant Control (FTC) methodology for a class of LPV descriptor systems that are represented under a polytopic LPV form. The aim of this FTC strategy is to compensate the effects of time-varying or constant actuator faults by designing an Adaptive Polytopic Observer (APO) which is able to estimate both the states of the system and the magnitude of the actuator faults. Based on the information provided by this APO, a new state feedback control law is derived in order to stabilize the system. Stability conditions of the designed observer and the state-feedback control are provided and solved through a set of Linear Matrix Inequalities (LMI) under equality constraints. The performance of the proposed Fault Tolerant Control scheme is illustrated using a two-phase flash system.

*Keywords:* Descriptor Systems, Observer, Fault Tolerant Control, Actuator Fault, LPV, Stability, LMI

---

## 1. Introduction

As control of systems become more and more complex, the security remains a key point and the development of new control theory which integrate the faults that can occur on a system, are of a great interest. Fault Diagnosis (Chen and Patton, 1999), (Bokor and Szabo, 2009) and Fault Tolerant Control (Blanke et al., 2006) have become challenging problems in the area of modern control theory. The concept of Fault Tolerant is based on the fact that when a fault (a sensor or an actuator for example) occurs on the system and provides an undesirable effect, the system can become unstable or be damaged. By the way, the basic idea of this concept is to be robust against such fault or to take into account the fault occurrence into a new control which will become tolerant to this fault by canceling its bad effects.

Fault Tolerant Control (FTC) techniques can be classified into two category (Zhang and Jiang, 2008): passive and active approaches. In passive FTC systems, a single controller with fixed structure or parameters is used to deal with all possible failure scenarios which are assumed to be known a priori. Consequently, the passive controller is usually conservative. Furthermore, if a failure that would not be considered in the design occurs, the stability and performance of the closed-loop system can not be guaranteed. Such potential limitations of passive approaches provide a strong motivation for the development of methods and strategies for Active FTC (AFTC) systems (Gao and Ding, 2007). In contrast to passive FTC systems, AFTC techniques rely on a real time fault detection and isolation (FDI) scheme and a controller reconfiguration mechanism. Such techniques allow a flexibility to select different controllers according to different component failures,

and therefore better performance of the closed-loop system can be expected. However, this holds true when the FDI process does not make an incorrect decision (Li et al., 2008). A FTC strategy is designed so as to reconfigure automatically the control law by ensuring the system stability and to get acceptable system performances (Theilliol et al., 2002), (Li et al., 2013). Observer based Fault Tolerant Control methods are also developed in order to estimate the fault and to reconfigure the control law (Mao et al., 2010). The authors in (Witczak et al., 2008) and (Ichalal et al., 2012) have developed a FDI/FTC strategy for regular Takagi-Sugeno (TS) systems where both the observer and the control are designed at the same time. However, all these previous above mentioned FTC technics are devoted only for normal (regular) systems whereas here in this paper, the main goal is to design an Active FTC strategy for descriptor (singular) systems.

Note that Takagi-Sugeno fuzzy systems have always used in the past membership functions that were computed by the fuzzy logic theory (Wang et al., 1996). But recently, both polytopic LPV systems and a part of fuzzy systems converge to a same structure. The community of people working on TS models uses the name "TS FUZZY systems" even if with the recent modeling approaches (for example sector nonlinearity transformation), the obtained model is no longer "fuzzy" because the weighting functions are completely deterministic which corresponds to LPV or quasi-LPV systems (NagyKiss et al., 2011).

Generally speaking, most of control research works for physical systems, use a *normal* (or *regular*) model i.e. there is no algebraic relations between

the system variables. However, Differential-Algebraic Equations (DAE) or implicit systems or *singular* systems or *descriptor* systems are of quite importance for the physical representation of some systems (Lewis, 1986). Such systems appear for example in electrical circuits, mechanical systems with holonomic or non holonomic constraints, robotic systems with kinematical constraints and chemical systems (Mattson et al., 1998). Some practical problems must take into account physical constraints or algebraic relations and more generally impulsive behaviors caused by an improper transfer matrix: see the following books on singular systems (Dai, 1989), (Duan, 2010).

Concerning FDI for descriptor systems, some authors have considered this problem as in (Darouach and Boutayeb, 1995), (Yousouf and Kinnaert, 1996) for the general linear case, (Astorga-Zaragoza et al., 2011), (Wang et al., 2012) for linear descriptor systems in discrete case by designing an observer through LMI study. New recent works on robust *H<sub>∞</sub>* control design by LMI for discrete-time descriptor systems can be found in (Chadli and Darouach, 2012), (Chadli and Darouach, 2013).

The concept of Linear Parameter Varying systems (LPV) allows the convenience associated with LTI models, and yet guarantees performance and stability over a more wide operating envelope. Some results about FDI have been developed for normal LPV systems as in (Alwi et al., 2012) by a sliding mode observer, (Bokor and Balas, 2004), (Armeni et al., 2009), (Bokor and Szabo, 2009) with a geometrical approach. Nonlinear systems are sometimes represented by a LPV modelization (Wu, 1995), (Wu et al., 2007), (Bruzelius, 2004), (Rodrigues et al., 2013) in order to use the technique developed in the linear case like the tools for stability purposes as LMI Toolboxes.

In (Wu and Zheng, 2009), (Wu et al., 2010), the authors have developed a technique for state estimation and sliding-mode control of Markovian jump singular systems and also by considering time-delay in (Wu et al., 2012). In (Li and Zhang, 2013), the authors have developed a robust  $H_\infty$  filtering for singular LPV systems with time varying delays so as to estimate the states of the system but without any FDI purposes. In (Hamdi et al., 2012), the authors have developed a robust FDI method based on a multiple models concept. In (Marx et al., 2004), the authors have developed a robust fault tolerant control for descriptor systems but only with constant matrices. In the paper of (Koenig, 2006), the author has introduced some useful necessary observability conditions for the design of unknown input observers for descriptor systems. A Fault Tolerant Control technique is presented for normal LPV systems under sensor faults in (Oca et al., 2011).

In (Hamdi et al., 2012), the authors have proposed a polytopic unknown inputs and proportional integral observers for LPV descriptor systems respectively. However, this technic can not ensure a correct fault estimation if the fault is time-varying. By this way, the authors in (Rodrigues et al., 2012), have performed their previous works by designing an Adaptive Observer in order to take into account time-varying faults for descriptor LPV systems. In a similar way, the authors in (Wang and Daley, 1996) have presented an adaptive fault diagnosis observer approach dedicated to regular LTI systems which can detect and estimate only constant faults. In (Zhang et al., 2008), the authors have performed this previous adaptive observer so as to estimate time-varying faults but only in a LTI case for regular systems.

In the papers (Rodrigues et al., 2005) and (Rodrigues et al., 2007), the authors have developed an active FTC strategy to avoid actuator fault/failure effects on polytopic LPV systems; however FDI was not performed and was supposed to be available and perfect. Moreover, very few contributions are dealing with Fault Tolerant Control for polytopic LPV descriptor system with a FDI scheme designed at the same time. The main contributions of this paper are:

- To design an Adaptive Polytopic LPV Observer (APO) that can estimate time-varying actuator faults. Some previous Fault Detection and Isolation (FDI) technics presented in (Astorga-Zaragoza et al., 2011), (Astorga-Zaragoza et al., 2012) and in (Hamdi et al., 2012) can only deal with constant faults for LPV descriptor systems.

- To integrate the information provided by the APO into a new state-feedback design so as to cancel the actuator fault effects with Fault Tolerant Control (FTC). The FDI and FTC parts are designed at the same time whereas most of FTC strategies deal with normal LTI or LPV systems and assume that the FDI part is perfect and not designed. For LPV descriptor systems, such strategy has never been used.

- To ensure both the stability of the APO and the Fault Tolerant Control by LMI under equality constraints for LPV descriptor systems.

So, in this paper, an integrated Fault Diagnosis (FD) and FTC design for polytopic LPV descriptor systems is provided. Polytopic LPV descrip-

tor system is a particular class of LPV systems which allows describing the system as a convex combination of sub-models defined by the vertices of a convex polytope. These sub-models are then combined by convex weighting functions that yield to a global model. Using an Adaptive Polytopic Observer (APO) that is able to provide both states and actuator faults estimation, it is possible to address the Fault Diagnosis (FD), and at the same time to build a new control which take into account the actuator fault estimation. The use of such Adaptive Polytopic Observer is motivated by the fact that, if a fault occurs, it is important to quickly detect and estimate it in order to preserve the system performance in spite of the presence of fault. Moreover, this APO is able to estimate time-varying fault which was not possible with our previous paper (Hamdi et al., 2012) and nor with (Astorga-Zaragoza et al., 2012). Stability analysis and sufficient conditions are obtained with the use of Linear Matrix Inequality (LMI) under equality constraint. A lot of works dealing with quadratic stability have been done as in (Cai et al., 2012) by the use of LMI or also for fault detection purposes (Zhang et al., 2012).

The structure of this paper is organized as follows: in Section 2, the class of the LPV descriptor systems is presented. Section 3 describes the problem statement. A method of designing the Adaptive Polytopic Observer is described in Section 4. Fault tolerant control by state feedback is tackled in Section 5, Finally, and before concluding, a numerical example that considers a two-phase flash system, is used to assess the validity of the proposed approach.

**Notations:** For symmetric matrices  $X > 0$  ( $X \geq 0$ ) indicates that  $X$  is positive definite (positive semi-definite). For any square matrix  $M$ ,  $\lambda_{max}(M)$  represents the maximum singular value of the matrix  $M$ . In a partitioned matrix, the star '\*' denotes the terms induced by symmetry.

## 2. Polytopic LPV descriptor systems modeling

Consider the following continuous-time LPV descriptor representation in the fault-free case:

$$\begin{cases} E\dot{x}(t) = \tilde{A}(\theta(t))x(t) + \tilde{B}(\theta(t))u(t) \\ y(t) = Cx(t) \end{cases} \quad (1)$$

where  $x(t) \in \mathbf{R}^n$  is the state vector,  $u(t) \in \mathbf{R}^p$  is the inputs vector,  $y(t) \in \mathbf{R}^m$  represents the measured outputs vector and  $\theta(t)$  is a varying parameter vector. Matrix  $E \in \mathbf{R}^{n \times n}$  may be singular and  $rank(E) = r < n$ .

It is assumed that all parameters  $\theta_i(t), i = 1, \dots, l$  are bounded, measurable as in (Alwi et al., 2012) and (Rodrigues et al., 2013), and their values remain in the domain of an hypercube such that (Wu, 1995):

$$\theta(t) \in \Gamma = \{\theta_i \mid \underline{\theta}_i \leq \theta_i(t) \leq \bar{\theta}_i\}, \quad \forall t \geq 0 \quad (2)$$

where  $\underline{\theta}_i$  and  $\bar{\theta}_i$  represent the minimum and maximum values of  $\theta_i(t)$ , respectively.

$\tilde{A}(\cdot), \tilde{B}(\cdot)$  are functions which depend affinely on the time-varying parameter vector  $\theta(t) \in \mathbb{R}^l$ .

The matrices  $\tilde{A}(\theta(t)), \tilde{B}(\theta(t))$  of the LPV system (1) with the affine parameter dependence (2) are represented such that:

$$\tilde{A}(\theta(t)) = \tilde{A}_0 + \sum_{i=1}^l \theta_i(t) \tilde{A}_i, \quad \tilde{B}(\theta(t)) = \tilde{B}_0 + \sum_{i=1}^l \theta_i(t) \tilde{B}_i \quad \forall \theta(t) \in \Gamma \quad (3)$$

The LPV system (1) with bounded parameters can be represented by a polytopic form where the summits  $S_i$  of the polytope are defined such that (Rodrigues et al., 2007):  $S_i = \begin{bmatrix} A_i & B_i & C \end{bmatrix}, \forall i \in [1, \dots, h]$  where  $h = 2^l$ . The polytopic coordinates are denoted  $\rho(\theta(t))$  and vary within the convex set  $\Omega$ :

$$\Omega = \left\{ \rho(\theta(t)) \in \mathbf{R}^h, \rho(\theta(t)) = [\rho_1(\theta(t)), \dots, \rho_h(\theta(t))]^T, \right. \\ \left. \rho_i(\theta(t)) \geq 0, \forall i, \sum_{i=1}^h \rho_i(\theta(t)) = 1 \right\} \quad (4)$$

Then, to ease the presentation, it is assumed that the matrices  $\tilde{A}(\cdot)$  and  $\tilde{B}(\cdot)$  are given by convex combinations  $\forall t \geq 0$ . Consequently, system (1) can be rewritten by a polytopic representation:

$$\begin{cases} E\dot{x}(t) = \sum_{i=1}^h \rho_i(\theta(t))(A_i x(t) + B_i u(t)) \\ y(t) = Cx(t) \end{cases} \quad (5)$$

where  $A_i \in \mathbf{R}^{n \times n}$ ,  $B_i \in \mathbf{R}^{n \times p}$  and  $C \in \mathbf{R}^{m \times n}$  are time invariant matrices defined for the  $i^{th}$  summit of the polytope.

### 3. Problem Statement

Let us consider an actuator fault on the previous descriptor system:

$$\begin{cases} E\dot{x}(t) = \sum_{i=1}^h \rho_i(\theta(t)) \left[ A_i x(t) + B_i (u(t) + f(t)) \right] \\ y(t) = Cx(t) \end{cases} \quad (6)$$

where  $A_i \in \mathbf{R}^{n \times n}$ ,  $B_i \in \mathbf{R}^{n \times p}$  and  $C \in \mathbf{R}^{m \times n}$  are time invariant matrices defined for the  $i^{th}$  model.  $f(t) \in \mathbf{R}^p$  is the actuator fault vector. Actuator faults can be represented by an additive or a multiplicative external signal as in (Rodrigues et al., 2007). These malfunctions of an actuator can be represented by a faulty control input  $u_f(t) = (I_p - \gamma)u(t)$  which can be rewritten as an external additive signal:  $u(t) + f(t)$  where  $f(t) = -\gamma u(t)$  with

$$\gamma \triangleq \text{diag}[\gamma^1, \gamma^2, \dots, \gamma^p], \quad 0 \leq \gamma^k \leq 1 \text{ such that} \quad (7)$$

$$\begin{cases} \gamma^k = 1 \rightarrow \text{a total failure of the } k^{th} \text{ actuator } k \in [1, \dots, p] \\ \gamma^k = 0 \rightarrow \text{the } k^{th} \text{ healthy actuator} \end{cases}$$

Note: in the following of the paper,  $\gamma^k \in [0 \ 1[$  i.e a total loss of an actuator is not considered here. The term  $\gamma^k$  represents the loss of effectiveness of  $k^{th}$  actuator, i.e. for example a loss of effectiveness 60% of  $1^{st}$  actuator will be represented by  $\gamma^1 = 0.60$ . When an actuator fault appears on the system, such actuator faults can cause system instability. Before starting the FTC design, we assume that (Darouach and Boutayeb, 1995), (Zhang et al., 2008) and (Hamdi et al., 2012):

**Assumption A1:**  $\text{rank}(CB_i) = \text{rank}(B_i) = p, \quad \forall i = 1, \dots, h,$

**Assumption A2:** The triple matrix  $(E, A_i, C)$  is R-observable, for all  $i = 1, \dots, h$ , i.e.,

$$\text{rank} \begin{bmatrix} sE - A_i \\ C \end{bmatrix} = n, \forall s \in \mathcal{C}. \quad (8)$$

where  $\mathcal{C}$  denotes the complex plane.

**Assumption A3:** The triple matrix  $(E, A_i, C)$  is Impulse-observable, for

all  $i = 1, \dots, h$ , i.e.,

$$\text{rank} \begin{bmatrix} E & A_i \\ 0 & E \\ 0 & C \end{bmatrix} = n + \text{rank}(E) \quad (9)$$

**Assumption A4:** The fault  $f(t)$  satisfies  $\|f(t)\| \leq \alpha_1$  and the derivative of  $f(t)$  with respect to time is norm bounded i.e.  $\|\dot{f}(t)\| \leq \alpha_2$  and  $0 \leq \alpha_1, \alpha_2 < \infty$ .

**Assumption A5:** Only partial actuator faults are considered, i.e.,  $\gamma^k \in [0 \ 1[$ .

Noting that, the R-observability characterizes the capacity to reconstruct only the state of the dynamic part and the Impulse-observability guarantees the capacity to estimate the state of static part of the descriptor system (6).

The main objective of an Active FTC is to find a control law such that the system remains stable despite the presence of actuator faults (Rodrigues et al., 2007), (Zhang and Jiang, 2008). For this purpose, a FDI procedure is necessary for estimating both the states and faults. In the following, an AFTC with a state feedback will be used such that:

$$u(t) = - \sum_{i=1}^h \rho_i(\theta(t)) K_i \hat{x}(t) - \hat{f}(t) \quad (10)$$

The following section is dedicated to synthesize an adaptive observer for Polytopic LPV descriptor systems.

#### 4. Adaptive Polytopic Observer Design

Consider the following Adaptive Polytopic Observer (APO) defined as:

$$\left\{ \begin{array}{l} \dot{z}(t) = \sum_{i=1}^h \rho_i(\theta(t))(N_i z(t) + G_i u(t) + R_i y(t) + B_i \hat{f}(t)) \\ \hat{x}(t) = z(t) + T_2 y(t) \\ \hat{y}(t) = C \hat{x}(t) \\ \dot{\hat{f}}(t) = \Gamma \sum_{i=1}^h \rho_i(\theta(t)) U_i (\dot{e}_y(t) + \sigma e_y(t)) \\ e_y(t) = y(t) - \hat{y}(t) = C e_x(t) \end{array} \right. \quad (11)$$

where  $z(t)$  is the state vector,  $\hat{f}(t)$  is an estimate of the fault  $f(t)$  and  $\hat{y}(t) = C \hat{x}(t)$  is the estimated output vector. The matrix  $\Gamma \in \mathbf{R}^f$  is a symmetric positive definite learning rate matrix.  $N_i$ ,  $G_i$ ,  $R_i$  and  $T_2$  are unknown matrices of appropriate dimensions to be determined. In the case of actuator faults, the matrix  $F_i$  of the Observer developed in (Rodrigues et al., 2012) is equal to  $B_i$ .

Let us define the following state estimation error  $e_x(t)$  from (6) and (11) such that:

$$e_x(t) = x(t) - \hat{x}(t) = (I_n - T_2 C)x(t) - z(t) \quad (12)$$

Since for  $\text{rank} \begin{bmatrix} E \\ C \end{bmatrix} = n$ , there exists nonsingular matrices  $T_1 \in \mathbf{R}^{n \times n}$  and  $T_2 \in \mathbf{R}^{n \times m}$  such that:

$$T_1 E + T_2 C = I_n \quad (13)$$

Then, the state estimation error (12) is described by:

$$e_x(t) = T_1 E x(t) - z(t) \quad (14)$$

and the actuator fault estimation error  $e_f(t)$  is defined by

$$e_f(t) = f(t) - \hat{f}(t) \quad (15)$$

First, the state estimation error dynamic is given by:

$$\dot{e}_x(t) = T_1 E \dot{x}(t) - \dot{z}(t) \quad (16)$$

By using (6) with the state feedback control law defined in (10), the equation (16) becomes after some calculations

$$\begin{aligned} \dot{e}_x(t) = & \sum_{i=1}^h \rho_i(\theta(t)) [N_i e_x(t) + (T_1 A_i - N_i T_1 E - R_i C)x(t) + (T_1 B_i - G_i)u(t) \\ & + (B_i + T_1 B_i - G_i)e_f(t) + (G_i - B_i)f(t)] \end{aligned} \quad (17)$$

Then, if the following conditions hold true  $\forall i = 1, \dots, h$ :

$$T_1 A_i - R_i C - N_i T_1 E = 0 \quad (18)$$

$$T_1 B_i - G_i = 0 \quad (19)$$

and by taking into account (6), (11) and (16), the state estimation error dynamic can be written as:

$$\dot{e}_x(t) = \sum_{i=1}^h \rho_i(\theta(t)) [N_i e_x(t) + B_i e_f(t) + M_i f(t)] \quad (20)$$

with  $M_i = (T_1 - I_n)B_i$ .

The substitution of (13) into (18) yields to:

$$N_i = T_1 A_i + (N_i T_2 - R_i)C = T_1 A_i + L_i C \quad (21)$$

where  $L_i = N_i T_2 - R_i$ .

Without loss of generality, let consider equation (13), one can write the following relationship:

$$\begin{bmatrix} T_1 & T_2 \end{bmatrix} \begin{bmatrix} E \\ C \end{bmatrix} = \begin{bmatrix} I_n \end{bmatrix} \quad (22)$$

A solution  $\begin{bmatrix} T_1 & T_2 \end{bmatrix}$  exists if (Darouach and Boutayeb, 1995), (Hamdi et al., 2012) :

$$\text{rank} \begin{bmatrix} E \\ C \end{bmatrix} = n \quad (23)$$

Then, a particular solution of (22) using the generalized inverse matrix denoted by  $(\cdot)^+$  is given by:

$$\begin{bmatrix} T_1 & T_2 \end{bmatrix} = \begin{bmatrix} E \\ C \end{bmatrix}^+ \quad (24)$$

Based on a fault estimation given by the APO, the objective of AFTC scheme is to design a feedback control law such that the system remains stable even if a fault occurs. The following section is dedicated to the stability conditions of this AFTC based on an actuator fault estimation from the Adaptive Polytopic Observer.

## 5. Fault Tolerant Control by State-Feedback and Fault Estimation

The dynamic of the state estimation error (20) and the closed-loop system with the control law (10) are defined as follows:

$$\dot{e}_x(t) = \sum_{i=1}^h \rho_i(\theta(t)) [N_i e_x(t) + B_i e_f(t) + M_i f(t)] \quad (25)$$

$$E\dot{x}(t) = \sum_{i=1}^h \sum_{j=1}^h \rho_i(\theta(t)) \rho_j(\theta(t)) [\Phi_{ij} x(t) + B_i K_j e_x(t) + B_i e_f(t)] \quad (26)$$

with  $N_i = T_1 A_i + L_i C$  and  $\Phi_{ij} = (A_i - B_i K_j)$ . The goal is to ensure the stability of these two differential equations.

### 5.1. Stability analysis

In order to investigate the stability criteria, let us consider the following Lemma:

**Lemma 1.** (Zhang et al., 2008) *Given a scalar  $\mu > 0$  and a symmetric positive definite matrix  $P_1$ , the following inequality holds:*

$$2x^T y \leq \frac{1}{\mu} x^T P_1 x + \mu y^T P_1^{-1} y \quad x, y \in \mathbf{R}^n \quad (27)$$

■

In contrast to (Hamdi et al., 2012), here time-varying faults are considered. Then, it follows that  $\dot{f}(t) \neq 0$  and consequently:

$$\dot{e}_f(t) = \dot{f}(t) - \hat{\dot{f}}(t) \quad (28)$$

**Theorem 1.** *Under Assumptions  $A_1$  to  $A_5$ , given scalars  $\sigma, \mu, \beta > 0$ , if there exists symmetric positive definite matrices  $X, Q, P_1, P_2$  and matrices  $W_i$  and*

$S_i$  such that,  $\forall i \in [1, \dots, h], \forall j \in [1, \dots, h]$ :

$$\begin{pmatrix} \Theta_{ij} & B_i W_j & B_i & 0 & 0 \\ * & -2\delta X & 0 & \delta I & 0 \\ * & * & -2\delta I & 0 & \delta I \\ * & * & * & \Omega_i & \Sigma_{ij} \\ * & * & * & * & \Upsilon_{ij} \end{pmatrix} < 0 \quad (29)$$

s.t.

$$E^T P_1 = P_1^T E \geq 0 \quad (30)$$

$$B_i^T Q - U_i C = 0 \quad (31)$$

where

$$\Theta_{ij} = (A_i X - B_i W_j) + (A_i X - B_i W_j)^T \quad (32)$$

$$\Omega_i = (Q T_1 A_i - S_i C) + (Q T_1 A_i - S_i C)^T + \frac{1}{\mu} P_1 \quad (33)$$

$$\Sigma_{ij} = -\frac{1}{\sigma} (A_j^T T_1^T Q - C^T S_j^T) B_i \quad (34)$$

$$\Upsilon_{ij} = -\frac{1}{\sigma} (B_i^T Q B_j + B_j^T Q B_i) + \frac{2}{\sigma \mu} P_2 \quad (35)$$

then, the state  $x(t)$  of the system, the state estimation error  $e_x(t)$  and the fault estimation error  $e_f(t)$  are bounded. The gains of the observer and the state feedback control law are given by  $L_i = Q^{-1} S_i$  and  $K_i = W_i X^{-1}$ . ■

**Proof 1.** In order to prove the stability of the closed-loop system and the convergence of the state and fault estimation errors, let consider the Lyapunov function depending on  $x(t)$ ,  $e_x(t)$  and  $e_f(t)$ :

$$V(t) = x^T E^T P_1 x + e_x^T(t) Q e_x(t) + \frac{1}{\sigma} e_f^T(t) \Gamma^{-1} e_f(t) \quad (36)$$

where  $P_1, Q$  and  $\Gamma$  are symmetric positive definite matrices with appropriate dimensions. Stability condition for the estimation error yields that the time derivative of the Lyapunov function (36) should be negative definite. By taking into account the equations (25) and (26), the derivative of  $V(t)$  with respect to time is:

$$\begin{aligned} \dot{V}(t) = & \sum_{i=1}^h \sum_{j=1}^h \rho_i(\theta(t)) \rho_j(\theta(t)) \{ (E\dot{x})^T P_1 x + x^T P_1^T E \dot{x} + e_x^T(t) [N_i^T Q + Q N_i] e_x(t) \\ & + 2e_x^T(t) Q M_i f(t) + 2e_x^T(t) Q B_i e_f(t) + \frac{1}{\sigma} \dot{e}_f^T(t) \Gamma^{-1} e_f(t) + \frac{1}{\sigma} e_f^T(t) \Gamma^{-1} \dot{e}_f(t) \} \end{aligned} \quad (37)$$

By considering equations (30), (28) and the expression of  $\hat{f}(t)$  in (11), we can obtain

$$\begin{aligned} \dot{V}(t) = & \sum_{i=1}^h \sum_{j=1}^h \rho_i(\theta(t)) \rho_j(\theta(t)) \{ x^T(t) \Pi_{ij} x(t) + e_x^T(t) \Omega_i e_x(t) + 2e_x^T(t) Q M_i f(t) \\ & + 2e_x^T(t) Q B_i e_f(t) + 2x^T P_1 B_i K_j e_x(t) + 2x^T P_1 B_i e_f(t) - \frac{2}{\sigma} e_f^T(t) U_i (\dot{e}_y(t) + \sigma e_y(t)) \\ & + \frac{2}{\sigma} e_f^T(t) \Gamma^{-1} \dot{f}(t) \} \end{aligned} \quad (38)$$

with  $e_y(t) = C e_x(t)$  and the following notations

$$\Pi_{ij} = \Phi_{ij}^T P_1 + P_1 \Phi_{ij} \quad (39)$$

$$\Omega_i = N_i^T Q + Q N_i \quad (40)$$

By using the equation (25), it follows that

$$\begin{aligned}
\dot{V}(t) &= \sum_{i=1}^h \sum_{j=1}^h \rho_i(\theta(t)) \rho_j(\theta(t)) \{x^T(t) \Pi_{ij} x(t) + e_x^T(t) \Omega_i e_x(t) + 2e_x^T(t) Q M_i f(t) \\
&+ 2e_x^T(t) Q B_i e_f(t) + 2x^T P_1 B_i K_j e_x(t) + 2x^T P_1 B_i e_f(t) - \frac{2}{\sigma} e_f^T(t) U_i C N_j e_x(t) \\
&- \frac{2}{\sigma} e_f^T(t) U_i C B_j e_f(t) - 2e_f(t)^T U_i C e_x(t) - \frac{2}{\sigma} e_f^T(t) U_i C M_j f(t) + \frac{2}{\sigma} e_f^T(t) \Gamma^{-1} \dot{f}(t)\}
\end{aligned} \tag{41}$$

By using Assumption  $A_1$  and the equality (31), it follows that

$$\begin{aligned}
\dot{V}(t) &= \sum_{i=1}^h \sum_{j=1}^h \rho_i(\theta(t)) \rho_j(\theta(t)) \{x^T(t) \Pi_{ij} x(t) + e_x^T(t) \Omega_i e_x(t) + 2e_x^T(t) Q M_i f(t) \\
&+ 2x^T P_1 B_i K_j e_x(t) + 2x^T P_1 B_i e_f(t) - \frac{2}{\sigma} e_f^T(t) B_i^T Q N_j e_x(t) - \frac{2}{\sigma} e_f^T(t) B_i^T Q B_j e_f(t) \\
&- \frac{2}{\sigma} e_f^T(t) B_i^T Q M_j f(t) + \frac{2}{\sigma} e_f^T(t) \Gamma^{-1} \dot{f}(t)\}
\end{aligned} \tag{42}$$

Now, using the Assumption  $A_4$  and applying Lemma 1 for three terms of the above inequality, it comes that:

$$\begin{aligned}
2e_x^T(t) Q M_i f(t) &\leq \frac{1}{\mu} e_x^T(t) P_1 e_x(t) + \mu f(t)^T (M_i^T Q P_1^{-1} Q M_i) f(t) \\
&\leq \frac{1}{\mu} e_x^T(t) P_1 e_x(t) + \mu \alpha_1^2 \lambda_{\max}(M_i^T Q P_1^{-1} Q M_i)
\end{aligned} \tag{43}$$

$$\begin{aligned}
\frac{2}{\sigma} e_f^T(t) \Gamma^{-1} \dot{f}(t) &\leq \frac{1}{\sigma \mu} e_f^T(t) P_2 e_f(t) + \frac{\mu}{\sigma} \dot{f}^T(t) (\Gamma^{-1} P_2^{-1} \Gamma^{-1}) \dot{f}(t) \\
&\leq \frac{1}{\sigma \mu} e_f^T(t) P_2 e_f(t) + \frac{\mu}{\sigma} \alpha_2^2 \lambda_{\max}(\Gamma^{-1} P_2^{-1} \Gamma^{-1})
\end{aligned} \tag{44}$$

$$\begin{aligned}
-\frac{2}{\sigma} e_f^T(t) B_i^T Q M_j f(t) &\leq \frac{1}{\sigma \mu} e_f^T(t) P_2 e_f(t) + \frac{\mu}{\sigma} f(t)^T (M_j^T Q B_i P_2^{-1} B_i^T Q M_j) f(t) \\
&\leq \frac{1}{\sigma \mu} e_f^T(t) P_2 e_f(t) + \frac{\mu}{\sigma} \alpha_1^2 \lambda_{\max}(M_j^T Q B_i P_2^{-1} B_i^T Q M_j)
\end{aligned} \tag{45}$$

$$\begin{aligned}
\dot{V}(t) &\leq \sum_{i=1}^h \sum_{j=1}^h \rho_i(\theta(t)) \rho_j(\theta(t)) \{x^T(t) \Pi_{ij} x(t) + e_x^T(t) \Omega_i e_x(t) + 2x^T P_1 B_i e_f(t) \\
&+ 2x^T P_1 B_i K_j e_x(t) - \frac{2}{\sigma} e_f^T(t) B_i^T Q N_j e_x(t) - \frac{2}{\sigma} e_f^T(t) B_i^T Q B_j e_f(t) + \frac{1}{\mu} e_x^T(t) P_1 e_x(t) \\
&+ \frac{2}{\sigma \mu} e_f^T(t) P_2 e_f(t)\} + \delta
\end{aligned} \tag{46}$$

where

$$\begin{aligned} \delta = \max_{i,j} & \left[ \mu \alpha_1^2 \lambda_{\max}(M_i^T Q P_1^{-1} Q M_i) + \frac{\mu}{\sigma} \alpha_2^2 \lambda_{\max}(\Gamma^{-1} P_2^{-1} \Gamma^{-1}) \right. \\ & \left. + \frac{\mu}{\sigma} \alpha_1^2 \lambda_{\max}(M_j^T Q B_i P_2^{-1} B_i^T Q M_j) \right] \end{aligned} \quad (47)$$

The inequality (46) can be reformulated as follows

$$\dot{V}(t) \leq \tilde{x}^T(t) \sum_{i=1}^h \sum_{j=1}^h \rho_i(\theta(t)) \rho_j(\theta(t)) \Xi_{ij} \tilde{x}(t) + \delta \quad (48)$$

where  $\tilde{x}(t) = \begin{pmatrix} x(t) \\ e_x(t) \\ e_f(t) \end{pmatrix}$  and

$$\Xi_{ij} = \begin{pmatrix} \Pi_{ij} & P_1 B_i K_j & P_1 B_i \\ * & \Omega_i + \frac{1}{\mu} P_1 & -\frac{1}{\sigma} B_i^T Q N_j \\ * & * & \Upsilon_{ij} \end{pmatrix} \quad (49)$$

$$\Upsilon_{ij} = -\frac{1}{\sigma} (B_i^T Q B_j + B_j^T Q B_i) + \frac{2}{\sigma \mu} P_2 \quad (50)$$

Then, by taking into account Assumption  $A_1$  and if the following inequality holds

$$\sum_{i=1}^h \sum_{j=1}^h \rho_i(\theta(t)) \rho_j(\theta(t)) \Xi_{ij} < 0 \quad (51)$$

We can obtain that

$$\dot{V}(t) \leq -\varepsilon \|\tilde{x}\|^2 + \delta \quad (52)$$

where  $\varepsilon > 0$  is given by

$$\varepsilon = \min \lambda_{\min} \left( - \sum_{i=1}^h \sum_{j=1}^h \rho_i(\theta(t)) \rho_j(\theta(t)) \Xi_{ij} \right) < 0 \quad (53)$$

which can also be bounded as follows

$$\varepsilon \leq \min_{i,j} \lambda_{\min} \left( - \Xi_{ij} \right) < 0 \quad (54)$$

Then,  $\dot{V}(t) < 0$  if  $\varepsilon \| \tilde{x} \|^2 > \delta, \forall t \geq 0$  which means that the state  $x(t)$ , the state estimation error  $e_x(t)$  and the fault estimation error  $e_f(t)$  converge to a small set according to Lyapunov stability theory and lie in it.

To complete the proof by considering (51), let us introduce the following notations

$$Z_\xi = \sum_{i=1}^h \rho_i(\theta(t)) Z_i \quad (55)$$

$$Z_{\xi\xi} = \sum_{i=1}^h \sum_{j=1}^h \rho_i(\theta(t)) \rho_j(\theta(t)) Z_{ij} \quad (56)$$

where  $Z_\xi$  and  $Z_{\xi\xi}$  are given matrices. By using these notations, the inequality (51) becomes

$$\Delta_{\xi\xi} = \begin{pmatrix} \Pi_{\xi\xi} & \mathcal{D}_{\xi\xi} \\ \mathcal{D}_{\xi\xi}^T & \Lambda_{\xi\xi} \end{pmatrix} \quad (57)$$

with

$$\mathcal{D}_{ij} = \begin{pmatrix} P_1 B_i K_j & P_1 B_i \end{pmatrix} \quad (58)$$

$$\Lambda_{ij} = \begin{pmatrix} \Omega_i + \frac{1}{\mu} P_1 & -\frac{1}{\sigma} B_i^T Q N_j \\ * & \Upsilon_{ij} \end{pmatrix} \quad (59)$$

Consider a symmetric matrix  $\mathcal{X}$  defined as

$$\mathcal{X} = \begin{pmatrix} P_1^{-1} & 0 \\ 0 & \mathcal{X}_1 \end{pmatrix}, \mathcal{X}_1 = \begin{pmatrix} P_1^{-1} & 0 \\ 0 & I \end{pmatrix} \quad (60)$$

By considering that for any positive definite matrix  $P$  and for any full column rank matrix  $Q$ , then  $QPQ^T$  is a positive definite matrix. Then, by post and pre-multiplying the inequality (57) by  $\mathcal{X}$ , we can obtain that

$$\begin{pmatrix} P_1^{-1}\Pi_{\xi\xi}P_1^{-1} & P_1^{-1}\mathcal{D}_{\xi\xi}\mathcal{X}_1 \\ * & \mathcal{X}_1\Lambda_{\xi\xi}\mathcal{X}_1 \end{pmatrix} \quad (61)$$

The term  $\mathcal{X}_1\Lambda_{\xi\xi}\mathcal{X}_1$  can be replaced by considering the following inequality which holds for any scalar  $\beta$  such that

$$\begin{aligned} (\mathcal{X}_1 + \beta\Lambda_{\xi\xi}^{-1})^T \Lambda_{\xi\xi} (\mathcal{X}_1 + \beta\Lambda_{\xi\xi}^{-1}) &\leq 0 \\ \Leftrightarrow \mathcal{X}_1\Lambda_{\xi\xi}\mathcal{X}_1 &\leq -2\beta\mathcal{X}_1 - \beta^2\Lambda_{\xi\xi}^{-1} \end{aligned} \quad (62)$$

Considering (62) and with the Schur Complement, the inequality (61) becomes

$$\begin{pmatrix} P_1^{-1}\Pi_{\xi\xi}P_1^{-1} & P_1^{-1}\mathcal{D}_{\xi\xi}\mathcal{X}_1 & 0 \\ * & -2\beta\mathcal{X}_1 & \beta I \\ * & * & \Lambda_{\xi\xi} \end{pmatrix} < 0 \quad (63)$$

Using the notations (55), (56) and the definitions of the matrices  $\Pi_{\xi\xi}$ ,  $\mathcal{D}_{\xi\xi}$  and  $\Lambda_{\xi\xi}$  given by (40), (58) and (59), by making the change of variables  $X = P_1^{-1}$ ,  $W_i = K_i X$ ,  $S_i = QL_i$ , we can obtain the inequalities given in Theorem 1 under equality constraint (31) which ends the proof.  $\square$

It can be noticed that the conservatism introduced by the use of a common Lyapunov function could be reduced by the use of parameter-dependent Lyapunov function so as to get other solutions (Rodrigues et al., 2013). Another strategy based on the Polyá's Theorem (Sala and Arino, 2007) could also be used even if the number of LMI to be solved will increase to reduce the conservatism.

## 6. Illustrative example

The proposed example considers a descriptor model of a two-phase flash system (Ben-Zvi et al., 2006) represented in Figure 1, in which a volatile component flashes out of a dilute binary mixture. It is assumed that the level control is nearly instantaneous and that the liquid and vapor phases are at the same temperature. Since only one component is volatile, the gas phase contains the pure volatile component. Accumulation of energy and matter in the gas phase are neglected because the mass of liquid in the flash vessel is considerably larger than the mass of gas.

The continuous isothermal reactor can be modeled by using a LPV descriptor representation as follows:

$$\begin{cases} E\dot{x}(t) = \tilde{A}(\theta(t))x(t) + \tilde{B}(\theta(t))u(t) \\ y(t) = Cx(t) \end{cases} \quad (64)$$

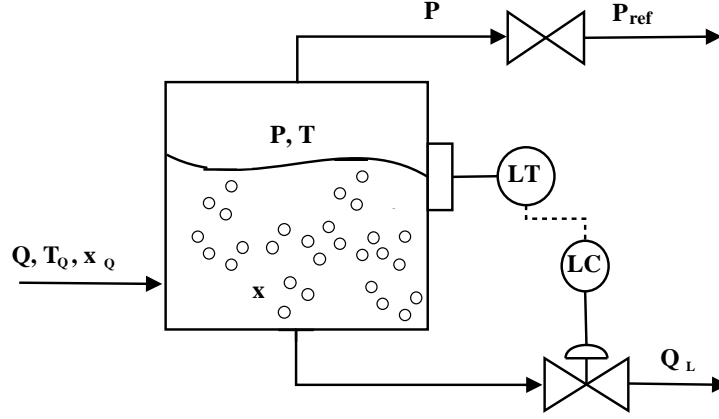

Figure 1: Flash tank system

where  $\tilde{A}(\theta(t)) =$

$$\begin{bmatrix}
 \frac{-M_w(Q_{L0} - (k_m A + \theta_1(t)))}{\rho V} & 0 & \frac{M_w(k_m A + \theta_1(t))}{\rho V} & 0 & \frac{M_w x_0}{\rho V} \\
 \frac{-(k_m A + \theta_1(t))(h_v + \theta_2(t))}{\rho V C_p} & \frac{M_w Q_{L0}}{\rho V} & \frac{(h_v + \theta_2(t))(k_m A + \theta_1(t))}{\rho V C_p} & 0 & \frac{M_w T_0}{\rho V} \\
 0 & 0 & 1 & \frac{-1}{H} & 0 \\
 0 & \frac{-b}{(T_0 + c)^2} & 0 & \frac{1}{P_0 \ln(10)} & 0 \\
 \frac{(k_m A + \theta_1(t))^2 (h_v + \theta_2(t))}{\rho V C_p} & \frac{-(k_m A + \theta_1(t)) M_w Q_{L0}}{\rho V} & \frac{-(k_m A + \theta_1(t))^2 (h_v + \theta_2(t))}{\rho V C_p} & 0 & \frac{-(k_m A + \theta_1(t)) M_w T_0}{\rho V}
 \end{bmatrix}$$

$$E = \begin{bmatrix}
 1 & 0 & 0 & 0 & 0 \\
 0 & 1 & 0 & 0 & 0 \\
 0 & 0 & 0 & 0 & 0 \\
 0 & 0 & 0 & 0 & 0 \\
 0 & 0 & 0 & 0 & 0
 \end{bmatrix}, \tilde{B}(\theta(t)) = \begin{bmatrix}
 \frac{-M_w x_Q}{\rho v} \\
 \frac{-M_w T_Q}{\rho v} \\
 0 \\
 0 \\
 \frac{(k_m A + \theta_1(t)) M_w T_Q}{\rho v}
 \end{bmatrix}, C = \begin{bmatrix}
 0 & 0 & 1 & 0 & 0 \\
 0 & 0 & 0 & 1 & 0 \\
 0 & 0 & 0 & 0 & 1
 \end{bmatrix}$$

where  $x_1(t)$ ,  $x_2(t)$ ,  $x_3(t)$ ,  $x_4(t)$  and  $x_5(t)$  are the Liquid mole fraction of volatile component, Flash tank temperature, Equilibrium mole fraction, Pressure in flash tank and Liquid out-flow rate respectively. So, we get:  $[x_1 \ x_2 \ x_3 \ x_4 \ x_5]^T = [x_L \ T \ x^* \ P \ Q_L]^T$ . The system parameters are listed in the following Table 1.

Variable	Definition	Values/Units
<b><i>state <math>x(t)</math></i></b>		
$x_L(t)$	Liquid mole fraction of volatile component	–
$T(t)$	Flash tank temperature	$K$
$x^*(t)$	Equilibrium mole fraction	–
$P(t)$	Pressure in flash tank	$KPa$
$Q_L(t)$	Liquid out-flow rate	$mol/s$
<b><i>Input <math>u(t)</math></i></b>		
$Q(t)$	Feed Flow rate	$4,377 mol/s$
<b><i>Parameters</i></b>		
$\rho V$	Mass of liquid	$23.7 kg$
$k_m A$	Mass-transfer coefficient	$0,12 \mp 15\% mol/s$
$h_v$	Heat of vaporization	$23,24 \mp 10\% kJ/mol$
<b><i>Known constants</i></b>		
$C_p$	Average heat capacity	$4.2 kJ/K.g$
$M_w$	Average molecular weight of liquid	$50 g/mol$
$C_v$	Valve flow coefficient	$16,8 (kPa)^{-1/2} mol/s$
$V$	Liquid volume	$19 m^3$
$x_Q$	Volatile component mol-fraction in feed	1
$T_Q$	Temperature of feed	$500 K$
$H$	Henry's Law constant	$313 K$
$P_{ref}$	Downstream pressure	$10 KPa$
$b$	Antoine Equation constant	$130.63 ^\circ C^{-1}$
$c$	Antoine Equation constant	$23.426 ^\circ C$

Parameters  $k_m A$  and  $h_v$  are considered as varying variables denoted respectively  $\theta_1(t)$  and  $\theta_2(t)$  which vary such that:  $\theta_1 \in [-0.018, 0.018]$  and  $\theta_2 \in [-2.32, 2.32]$ ,

$l = 2$ . As usually done in LPV framework and as in system (1), these parameters are assumed to be available as in (Alwi et al., 2012) or in (Rodrigues et al., 2013). As there are 2 parameters which vary in this LPV descriptor system (64), then  $2^2 = 4$  models are considered as explained in Section 2. The parameters evolution functions  $\rho(\theta(t))$  vary within a convex set like in (4) and are depicted in Figure (2). In this case, the descriptor polytopic LPV representation (64) can be rewritten as follows:

$$\begin{cases} E\dot{x}(t) = \sum_{i=1}^4 \rho_i(\theta(t))(A_i x(t) + B_i(u(t) + f(t))) \\ y(t) = Cx(t) \end{cases} \quad (65)$$

The matrices of the system can be determined at the vertices of the polytope for extrema values of parameters  $\rho_i$ . So, matrices  $A_i$  are defined as follows:

$$A_1 = \begin{bmatrix} -0.8223 & 0 & 0.5279 & 0 & 1.0127 \\ -0.3011 & 0.6751 & 0.3011 & 0 & 201.1814 \\ 0 & 0 & 1 & -0.0484 & 0 \\ 0 & -0.0013 & 0 & 0.3967 & 0 \\ 0.2355 & -0.5279 & -0.2355 & 0 & -157.3239 \end{bmatrix}$$

$$A_2 = \begin{bmatrix} -0.8223 & 0 & 0.5279 & 0 & 1.0127 \\ -0.3376 & 0.6751 & 0.3376 & 0 & 201.1814 \\ 0 & 0 & 1 & -0.0484 & 0 \\ 0 & -0.0013 & 0 & 0.3967 & 0 \\ 0.2640 & -0.5279 & -0.2640 & 0 & -157.3239 \end{bmatrix}$$

$$A_3 = \begin{bmatrix} -0.7980 & 0 & 0.5522 & 0 & 1.0127 \\ -0.3150 & 0.6751 & 0.3150 & 0 & 201.1814 \\ 0 & 0 & 1 & -0.0484 & 0 \\ 0 & -0.0013 & 0 & 0.3967 & 0 \\ 0.2577 & -0.5522 & -0.2577 & 0 & -164.5664 \end{bmatrix}$$

$$A_4 = \begin{bmatrix} -0.7980 & 0 & 0.5522 & 0 & 1.0127 \\ -0.3531 & 0.6751 & 0.3531 & 0 & 201.1814 \\ 0 & 0 & 1 & -0.0484 & 0 \\ 0 & -0.0013 & 0 & 0.3967 & 0 \\ 0.2889 & -0.5522 & -0.2889 & 0 & -157.3239 \end{bmatrix} \text{ and } B_i = B = \begin{bmatrix} -1.2152 \\ -251.8143 \\ 0 \\ 0 \\ 201.4515 \end{bmatrix}$$

The weighting functions  $\rho_i(\theta(t))$  are defined as combinations of  $\theta_j$  (Hamdi et al., 2012) and are given as follows:

$$\rho_1(\theta(t)) = \frac{\theta_1(t) - \underline{\theta}_1}{\bar{\theta}_1 - \underline{\theta}_1} \frac{\theta_2(t) - \underline{\theta}_2}{\bar{\theta}_2 - \underline{\theta}_2} = \frac{(\theta_1(t) + 0.018)(\theta_2(t) + 2.32)}{0.167}$$

$$\rho_2(\theta(t)) = \frac{\theta_1(t) - \underline{\theta}_1}{\bar{\theta}_1 - \underline{\theta}_1} \frac{\bar{\theta}_2 - \theta_2(t)}{\bar{\theta}_2 - \underline{\theta}_2} = \frac{(\theta_1(t) + 0.018)(2.32 - \theta_2(t))}{0.167}$$

$$\rho_3(\theta(t)) = \frac{\bar{\theta}_1 - \theta_1(t)}{\bar{\theta}_1 - \underline{\theta}_1} \frac{\theta_2(t) - \underline{\theta}_2}{\bar{\theta}_2 - \underline{\theta}_2} = \frac{(0.018 - \theta_1(t))(\theta_2(t) + 2.32)}{0.167}$$

$$\rho_4(\theta(t)) = \frac{\bar{\theta}_1 - \theta_1(t)}{\bar{\theta}_1 - \underline{\theta}_1} \frac{\bar{\theta}_2 - \theta_2(t)}{\bar{\theta}_2 - \underline{\theta}_2} = \frac{(0.018 - \theta_1(t))(2.32 - \theta_2(t))}{0.167}$$

Remark: Note that Parameters  $k_m A$  and  $h_v$  can be measured by the distinct ways; For the measurement of  $h_v$  (enthalpy of vaporization), let us consider that the change of state of a pure substance is made with constant pressure P and constant temperature T. The heat of the reaction corresponds to a change of enthalpy  $h_v$  since the pressure is constant. With constant pressure P, it is called latent heat of state change. The molar enthalpy change of state or mass enthalpy change of state corresponds to the amount of heat required per unit of amount of substance (mol)

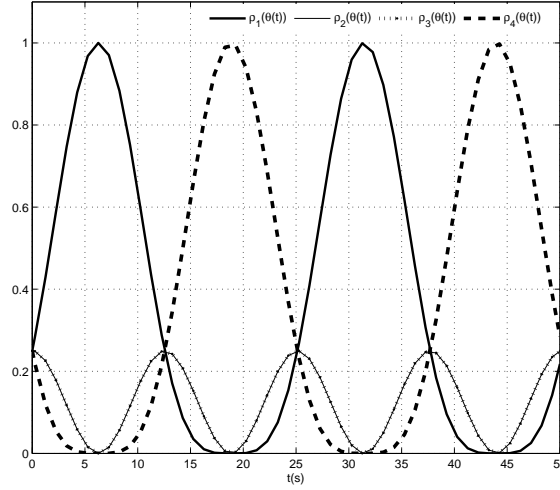

Figure 2: Parameters evolutions  $\rho_i$

or mass (kg) of body so it changes state. For example, for the passage from the liquid state to the vapor state, one speak about vaporization enthalpy (or latent heat of vaporization). The latent heat or enthalpy (in Joules) can be expressed as follows:

$$\Delta h_v = nC_p\Delta T$$

$\Delta h_v$  : variation of the heat of vaporization

$\Delta T$  : variation of temperature

$n$  : number of moles

$C_p$  : average heat capacity

The molar latent heat or molar enthalpy (in Joules/mol) is given by

$$\Delta h_v^{molar} = \frac{\Delta h_v}{n}$$

By the way, we measure  $h_v$  by measuring the temperature variations  $\Delta T$  (with constant pressure).

The physical measurement method of the coefficient of mass transfer  $k_m A$  consists of measuring the oxygen concentration  $C_e$  before the entry of the reactor, and the oxygen concentration inside the reactor  $C_L$ . The liquid phase in the reactor is assumed to be perfectly mixed. The coefficient  $k_m A$  can be deduced from the following expression:

$$k_m A.V(C^* - C_L) = Q_L(C_L - C_e)$$

$C^*$  : saturation of oxygen concentration in the liquid

$C_L$  : oxygen concentration inside the reactor

$C_e$  : oxygen concentration before entering in the reactor

$Q_L$  : liquid out-flow rate

$V$  : liquid volume

### 6.1. Fault tolerant control design for a two-phase flash system

Let us consider an additive actuator fault signal  $f(t)$  affecting the polytopic LPV descriptor system (6) defined as follows:

$$\begin{aligned} f(t) &= 0, & t < 15s \\ f(t) &= 25\sin(2.5t), & 15s \leq t < 25s \\ f(t) &= 15, & 25s \leq t < 35s \\ f(t) &= 0, & t > 35s \end{aligned}$$

The observer based control law given by the equations (11), is designed by solving the LMI problem defined in the Theorem 1. One can check that the necessary assumptions (A2) and (A3) are verified. Afterwards and according to the proposed methodology defined in paragraph 4, matrices  $T_1$  and  $T_2$  can be computed from equation (24). The gains matrices of the APO and the controllers are obtained by solving the LMIs (29) with parameter value  $\delta = 1,442$ .

$$\begin{aligned}
L_1 &= \begin{bmatrix} -0.7905 & -0.7147 & -2.1275 \\ -174.7141 & -231.1559 & -537.6705 \\ -12.8643 & -0.8337 & -0.7042 \\ -0.3478 & -12.4030 & -0.2258 \\ -233.1793 & -222.3492 & -118.8419 \end{bmatrix}, L_2 = \begin{bmatrix} -1.5590 & -1.5266 & -2.7960 \\ -437.1092 & -507.7838 & -786.0505 \\ -13.0101 & -0.9684 & -0.8103 \\ -0.3173 & -12.3811 & -0.1930 \\ -213.1735 & -202.8134 & -115.9478 \end{bmatrix} \\
L_3 &= \begin{bmatrix} -5.5749 & 0.3908 & -4.6427 \\ -307.8523 & -332.0796 & -549.2024 \\ -14.1713 & -2.8035 & -2.1476 \\ -3.0905 & -13.3019 & -2.4077 \\ -122.3051 & -68.0098 & -94.6731 \end{bmatrix}, L_4 = \begin{bmatrix} -0.0586 & -1.0962 & -1.4895 \\ -163.1733 & -149.9693 & -511.7788 \\ -12.6399 & -0.6354 & -0.3416 \\ -1.0167 & -12.8870 & -2.1877 \\ -201.5105 & -114.0819 & -93.7544 \end{bmatrix} \\
K_1 &= \begin{bmatrix} -0.0382 & -0.0429 & 0.0250 & 0 & 0.4862 \end{bmatrix} \\
K_2 &= \begin{bmatrix} -0.0424 & -0.0433 & 0.0281 & 0 & 0.4856 \end{bmatrix} \\
K_3 &= \begin{bmatrix} -0.0395 & -0.0430 & 0.0263 & 0 & 0.4860 \end{bmatrix} \\
K_4 &= \begin{bmatrix} -0.0439 & -0.0435 & 0.0295 & 0 & 0.4853 \end{bmatrix} \\
U &= \begin{bmatrix} -0.8457 & 2.9547 & 0.5406 \end{bmatrix}, \text{ for } i = 1, \dots, 4
\end{aligned}$$

Simulations have been realized by applying a random noise with maximal magnitude 0.01 in the output measurements. The actuator fault and its estimate are depicted on Figure 3. One can see the good estimation of this time-varying actuator fault by the use of the APO despite an additive noise. This actuator fault estimation is also used into the control law given in (10) so as to make the system robust against this actuator fault. Moreover, it should be noticed that the fault estimation error  $e_f(t)$  depicted in Figure 4 is zero-mean that underlines an accurate fault magnitude estimation. Note that abrupt changes of the fault can generate some peaks in Figure 4 at time 15s, 25s and 35s. Similar peaks have been

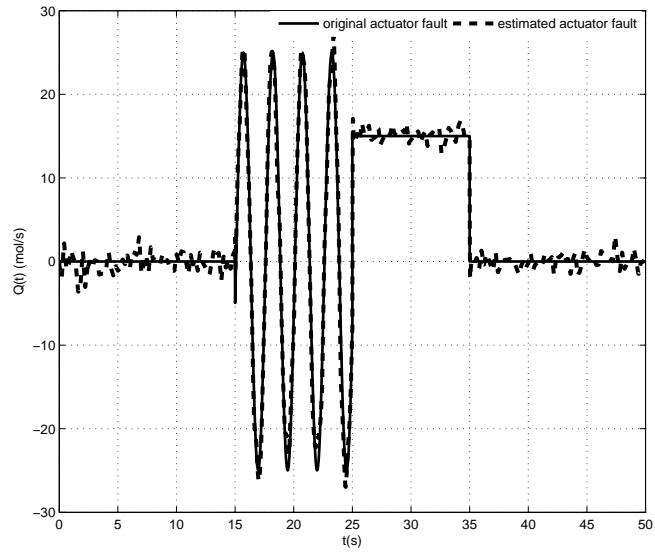

Figure 3: Actuator fault and its estimated

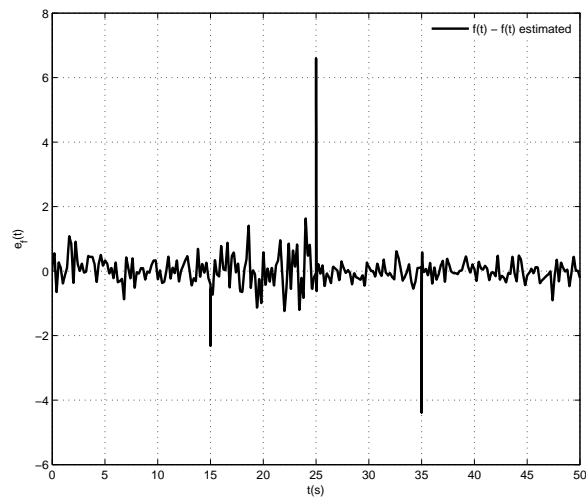

Figure 4: Fault estimation error  $e_f(t)$

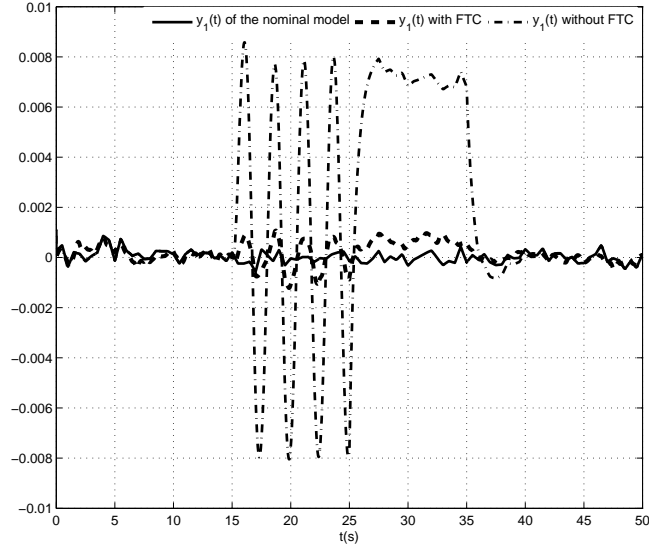

Figure 5:  $y_1(t)$  of the system: nominal output, output without FTC and output with FTC

noticed into the example part of (Rodrigues et al., 2013) for the same reasons.

The Figures (5-7) illustrate a comparison between the outputs of the nominal model (i.e. without any fault), the outputs of the faulty system without FTC (with a classical control law by a state feedback) and finally the outputs with our proposed FTC. It can be noticed that the outputs without FTC do not converge to the nominal dynamic: it underlines that the system is perturbed by the actuator fault and it is not robust against such faults. The proposed APO under the Fault Tolerant control law (10) makes the system robust against actuator fault since the outputs's trajectories of the system with FTC reach the outputs of nominal model.

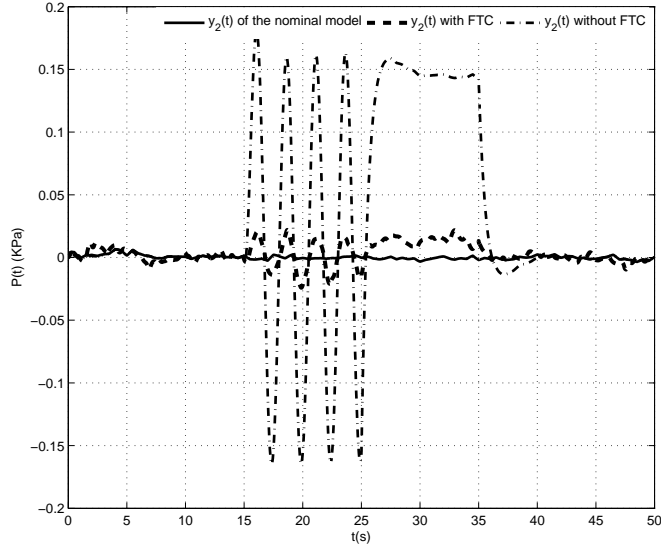

Figure 6:  $y_2(t)$  of the system: nominal output, output without FTC and output with FTC

For comparison, the nominal state feedback controller (without taking into account faults occurrences) and the proposed FTC control are plotted simultaneously in Figures (5-7). The FTC scheme can well accommodate the actuator fault. Here, the Adaptive Polytopic Observer shows good results for the estimation of both time-varying or abrupt actuator fault in spite of the presence of an additive noise. An extension of this paper should consider Fault-Tolerant Control for Markovian systems as in (Liu et al., 2011) with our FTC strategy.

## 7. Conclusion

In this paper, an actuator Fault Tolerant Control methodology to address polytopic LPV descriptor system has been studied. The FTC scheme is based on an Adaptive Polytopic Observer that is able to simultaneously estimate time varying

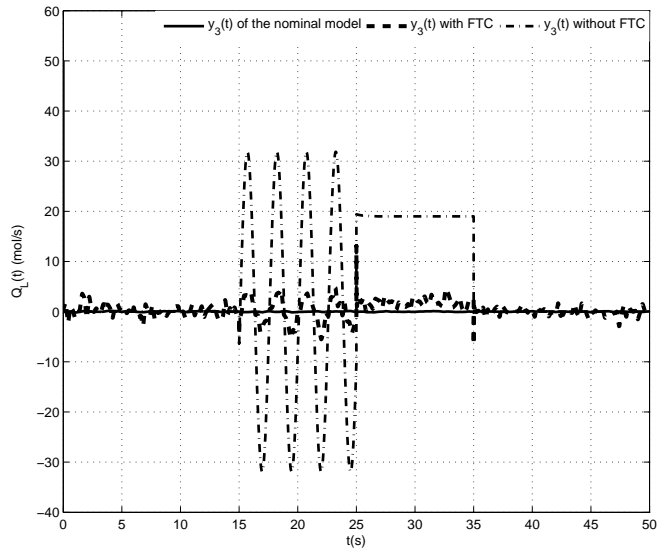

Figure 7:  $y_3(t)$  of the system: nominal output, output without FTC and output with FTC

faults and state variables with a good accuracy. The stability analysis has been formulated and solved within a set of linear matrix inequalities under equalities constraints. The developed scheme has been applied to a two-phase flash system with an additive actuator fault so as to illustrate the effectiveness of this method.

## References

- J. Chen, R. Patton, Robust model-based fault diagnosis for dynamic systems, Kluwer Academic Publishers (1999).
- J. Bokor, Z. Szabo, Fault detection and isolation in nonlinear systems, Annual Reviews in Control. 33 (2009) 113–123.

- M. Blanke, M. Kinnaert, J. Lunze, M. Staroswiecki, *Diagnosis and fault tolerant control*, (2nd Edition) Springer, Berlin, Germany, 2006.
- Y. Zhang, J. Jiang, Bibliographical review on reconfigurable fault-tolerant control systems, *Annual Reviews in Control*. 32 (2008) 229–252.
- Z. Gao, S. X. Ding, Actuator fault robust estimation and fault-tolerant control for a class of nonlinear descriptor systems, *Automatica* 43 (2007) 912–920.
- S. Li, D. Sauter, C. Aubrun, J. Yame., Stability guaranteed active fault-tolerant control of networked control systems, *Journal of Control Science and Engineering* (2008). Doi:10.1155/2008/189064, 2008.
- D. Theilliol, H. Noura, J. Ponsart, Fault diagnosis and accommodation of three-tank system based on analytical redundancy, *ISA Transactions* 41 (2002) 365–382.
- Q. Li, Z. Ren, S. Dai, W. Wang, A new robust fault-tolerant controller for self-repairing flight control system, *Journal of The Franklin Institute* (2013). [Http://dx.doi.org/10.1016/j.jfranklin.2013.02.020](http://dx.doi.org/10.1016/j.jfranklin.2013.02.020), 2013.
- Z. Mao, B. Jiang, P. Shi, Observer based fault-tolerant control for a class of nonlinear networked control systems, *Journal of The Franklin Institute* 347 (2010) 940–956.
- M. Witczak, L. Dziekan, V. Puig, J. Korbicz, Design of a fault-tolerant control scheme for takagi-sugeno fuzzy systems, 16th Mediterranean Conference on Control and Automation, MED08, Ajaccio, 2008.
- D. Ichalal, B. Marx, J. Ragot, D. Maquin, New fault tolerant control strategies for nonlinear takagi-sugeno systems, *International Journal of Applied Mathematics and Computer Science*, AMCS 22 (2012) 197–210.

- H. Wang, K. Tanaka, M. Griffin, An approach to fuzzy control of nonlinear systems: stability and design issues, *IEEE Transactions on Fuzzy systems* 4 (1996) 14–23.
- A. NagyKiss, B. Marx, G. Mourot, G. Schutz, J. Ragot, State estimation of two-time scale multiple models. application to wastewater treatment plant, *Control Engineering Practice* 19 (2011) 1354–1362.
- F. L. Lewis, A survey of linear singular systems, *Circuits Systems and Signal Processing* 5 (1986) 3–36.
- S. Mattson, H. Elmqvist, M. Otter, Physical system modeling with modelica, *Control Engineering Practice* 6 (1998) 501–510.
- L. Dai, *Singular Control Systems*, Springer, Germany, 1989.
- G.-R. Duan, *Analysis and Design of descriptor Linear Systems Advances in Mechanics and Mathematics*, Springer, 2010.
- M. Darouach, M. Boutayeb, Design of observers for descriptor systems, *IEEE Transactions on Automatic Control* 75 (1995) 490–501.
- A. Youssouf, M. Kinnaert, Observer based residual generator for singular systems, in: *Proceedings of the 35th Conference on Decision and Control 1996*, Kobe, Japan, pp. 1175–1180.
- C.-M. Astorga-Zaragoza, D. Theilliol, J.-C. Ponsart, M. Rodrigues, Observer synthesis for a class of a descriptor LPV systems, in: *American Control Conference ACC2011*, Etats-Unis, USA.
- Z. Wang, Y. Shen, X. Zhang, Q. Wang, Observer design for discrete-time descriptor systems: An LMI approach, *Systems and Control Letters* 61 (2012) 683–687.

- M. Chadli, M. Darouach, Novel bounded real lemma for discrete-time descriptor systems: Application to hinfinity control design, *Automatica* 48 (2012) 449–453.
- M. Chadli, M. Darouach, Further enhancement on robust *h<sub>i</sub>nfinity* control design for discrete-time singular systems, *IEEE Transactions on Automatic Control* (2013). Doi 10.1109/TAC.2013.2273266.
- H. Alwi, C. Edwards, A. Marcos, Fault reconstruction using a LPV sliding mode observer for a class of LPV systems, *Journal of The Franklin Institute* 349 (2012) 510–530.
- J. Bokor, G. Balas, Detection filter design for LPV systems: a geometric approach, *Automatica* 40 (2004) 511–518.
- S. Armeni, A. Casavola, E. Mosca, Robust fault detection and isolation for lpv systems under a sensitivity constraint, *International Journal of Adaptive Control and Signal Processing* 23 (2009) 55–72.
- F. Wu, *Control of Parameter Varying Systems*, University of California at Berkeley, USA, 1995.
- L. Wu, Z. Wang, H. Gao,  $h_{\infty}$  and  $l_2 - l_{\infty}$  filtering for two-dimensional linear parameter-varying systems, *International Journal of Robust and Nonlinear Control* 17 (2007) 1129–1154.
- F. Bruzelius, *Linear Parameter-Varying Systems an approach to gain scheduling*, Department of Signals and Systems, Chalmers University of Technology, Goteborg, Sweden, 2004.
- M. Rodrigues, M. Sahnoun, D. Theilliol, J.-C. Ponsart, Sensor fault detection and isolation filter for polytopic LPV systems: A winding machine application, *Journal of Process Control* 23 (2013) 805–816.

- L. Wu, W. Zheng, Passivity-based sliding mode control of uncertain singular time-delay systems, *Automatica* 45 (2009) 2120–2127.
- L. Wu, P. Shi, H. Gao, State estimation and sliding-mode control of markovian jump singular systems, *IEEE Transactions on Automatic Control* 55 (2010) 1213–1219.
- L. Wu, X. Su, P. Shi, Sliding mode control with bounded  $l_2$  gain performance of markovian jump singular time-delay systems, *Automatica* 48 (2012) 1929–1933.
- F. Li, X. Zhang, Delay-range-dependent robust  $h_\infty$  filtering for singular lpv systems with time variant delay, *International Journal of Innovative Computing, Information and Control* 9 (2013) 339–353.
- H. Hamdi, M. Rodrigues, C.Mechmeche, N. B. Braïek, Robust fault detection and estimation for descriptor systems based on multi-models concept, *International Journal of Control, Automation and Systems* 10 (2012) 1260–1266.
- B. Marx, D. Koenig, D. Georges, Robust fault tolerant control for descriptor systems, *IEEE Transactions on Automatic Control* 49 (2004) 1869–1876.
- D. Koenig, Observers design for unknown input nonlinear descriptor systems via convex optimization, *IEEE Transactions on Automatic Control* 51 (2006) 1047–1052.
- S. M. D. Oca, D. Rotondo, F. Nejjari, V. Puig, Fault estimation and virtual sensor FTC approach for LPV systems, in: 50th IEEE Conference on Decision and Control and European Control Conference (CDC-ECC), CD-Rom, Orlando, USA.

- H. Hamdi, M. Rodrigues, C. Mechmeche, D. Theilliol, N. B. Braiek, Fault detection and isolation in linear parameter-varying descriptor systems via proportional integral observer, *International Journal of Adaptive Control and Signal Processing* 26 (2012) 224–240.
- M. Rodrigues, H. Hamdi, D. Theilliol, C. Mechmeche, N. B. Braiek, Fault diagnosis based on adaptive polytopic observer for LPV descriptor systems, in: *Proceedings of 8th IFAC Symposium SAFEPROCESS: Fault Detection, Supervision and Safety for Technical Processes*, CD-Rom, 2012, Mexico City, Mexico.
- H. Wang, S. Daley, Actuator fault diagnosis: An adaptive observer-based technique, *IEEE Transactions on Automatic Control* 41 (1996) 1073–1078.
- K. Zhang, B. Jiang, V. Cocquempot, Adaptive observer-based fast fault estimation, *International Journal of Control, Automation and Systems* 6 (2008) 320–326.
- M. Rodrigues, D. Theilliol, D. Sauter, Design of an Active Fault Tolerant Control for Nonlinear Systems described by a Multi-Model Representation, in: *Proc. The 20th IEEE International Symposium on Intelligent Control (ISIC'05) and the 13th Mediterranean Conference on Control and Automation (MED'05)*, Limassol, Cyprus.
- M. Rodrigues, D. Theilliol, S. Aberkane, D. Sauter, Fault tolerant control design for polytopic LPV system, *International Journal of Applied Mathematics and Computer Science* 17 1 (2007) 27–37.
- C.-M. Astorga-Zaragoza, D. Theilliol, J. C. Ponsart, M. Rodrigues, Fault diagnosis for a class of descriptor linear parameter-varying systems, *International Journal of Adaptive Control and Signal Processing* 26 (2012) 208–223.

- G. Cai, C. Hu, G. Duan, Efficient lmi-based quadratic stability and stabilization of parameter-dependent interval systems with applications, *International Journal of Innovative Computing, Information and Control* 8 (2012) 1943–1954.
- D. Zhang, H. Wang, B. Lu, Z. Wang, Lmi-based fault detection fuzzy observer design with multiple performance constraints for a class of non-linear systems: Comparative study, *International Journal of Innovative Computing, Information and Control* 8 (2012) 633–645.
- A. Sala, C. Arino, Asymptotically necessary and sufficient conditions for stability and performance in fuzzy control: Applications of polya’s theorem, *Fuzzy Sets and Systems* 158 (2007) 2671–2686.
- A. Ben-Zvi, P. J. McLellan, K. B. McAuley, Identifiability of non-linear differential algebraic systems via a linearization approach, *Canadian Journal of Chemical Engineering* 84 (2006) 590–596.
- M. Liu, P. Shi, L. Zhang, X. Zhao, Fault-tolerant control for nonlinear markovian jump systems via proportional and derivative sliding mode observer technique, *IEEE Transactions on Circuits and Systems, Part I* 58 (2011) 2755–2764.