



**HAL**  
open science

## Demodulation of aggregated RF Signal in three Frequencies bands with a Unique Rx Chain

Abdou Kaissoine, Bernard Huyart, Kais Mabrouk

► **To cite this version:**

Abdou Kaissoine, Bernard Huyart, Kais Mabrouk. Demodulation of aggregated RF Signal in three Frequencies bands with a Unique Rx Chain. Microwave Conference (EuMC), 2013 European, 2013, pp.561 - 564, 13999624. hal-00959676

**HAL Id: hal-00959676**

**<https://hal.science/hal-00959676>**

Submitted on 17 Mar 2014

**HAL** is a multi-disciplinary open access archive for the deposit and dissemination of scientific research documents, whether they are published or not. The documents may come from teaching and research institutions in France or abroad, or from public or private research centers.

L'archive ouverte pluridisciplinaire **HAL**, est destinée au dépôt et à la diffusion de documents scientifiques de niveau recherche, publiés ou non, émanant des établissements d'enseignement et de recherche français ou étrangers, des laboratoires publics ou privés.

# Demodulation of aggregated RF Signal in three Frequencies bands with a Unique Rx Chain

A. Kaissoine<sup>#1</sup>, B. Huyart<sup>#1</sup>, K. Mabrouk<sup>\*2</sup>

<sup>#</sup> *Communication & Electronique Dpt, Institut Télécom, Télécom-ParisTech  
46 rue Barrault, 75634 Paris cedex 13, France*

<sup>1</sup>abdou.kaissoine@telecom-paristech.fr

<sup>1</sup>huyart@telecom-paristech.fr

<sup>\*</sup>*AllianSTIC, Esigetel  
Fontainebleau, France*

<sup>2</sup>kais.mabrouk@esigetel.fr

**Abstract**— Among the concerns of 4th generation wireless communication networks, there is the lack of desired bandwidth in a continuous manner in the frequency spectrum. The recommended solution is to transport the information on a Radio Frequency (RF) signal constituted of discontinuous frequency bands. Nowadays, the receiver architecture is generally constituted of  $n$  chains of receiver (Rx),  $n$  being the number of aggregated frequency bands. This paper demonstrates theoretically and practically that the demodulation of a RF signal having three discontinuous frequency bands can be made by a single Rx chain. The principle consists in down converting aggregated RF signal by mixing with a local oscillator (LO) signal constituted by  $n$  Continuous Wave (CW) signals. Using this technique the transposed signals occupy a narrow frequency band.

**Keywords**— *spectrum aggregation; down converter; RF receiver; LTE-Advanced; Three phase demodulator; Zero-IF; Low-IF*

## I. INTRODUCTION

The frequency band of RF signal used in 4th generation mobile communication networks, also known as LTE-A (Long Term Evolution Advanced), will reach values of the order of 100MHz in order to provide high data rate of 1 Gbits/s [1], [2], [3]. This bandwidth is available in the high frequency spectrum, but due to limits of the RF propagation channel, it is planned to transmit the information on different carrier frequencies. The spectrum of the RF signal is so composed of discontinuous frequency bands. Today, telecom operators like AT & T, for example, plan to use the aggregation of band 4 (1710-1785 MHz) and band 17 (734-746 MHz) [1]. The usual solution for designing the receiver is to double the number of Rx chain in order to simultaneously demodulate both frequency bands of the RF signal. In the case of 2 bands, another way is to use the architecture of the Weaver demodulator and a LO frequency equals

approximately to the half of both carrier frequencies [4], [5]. However, in the case where the number of aggregated frequency bands is upper than 2, these solutions become expensive or unworkable. In parallel to our research works, a team of NTT published in [6] practical results on the transposition by a mixer of a RF signal constituted of two frequency bands. The used technique is similar to that developed in this paper and consists in using a LO signal composed of two CW frequency tones.

In this paper, the technique of mixing with a multi-tone LO signal is applied directly to the demodulation of a RF signal which has spectral components distributed on three different frequency bands. The theoretical principle is given in section II and is validated by measurement results which are presented in section III.

## II. THE PRINCIPLE OF THE DOWN CONVERSION OF FREQUENCY AGGREGATED SIGNALS

The technique is the mixing of the frequency aggregated RF signal with a LO signal composed of 3 CW signals. Let us consider a RF signal composed of three discontinuous frequency bands centered respectively at frequencies  $f_1, f_2$  and  $f_3$  and of bandwidth  $BW_1, BW_2$  and  $BW_3$ . The expression of the aggregated RF signal is defined as follows:

$$v_{RF}(t) = \text{Re} \left[ \sum_{j=1}^3 Z_j(t) e^{j2\pi f_j t} \right] \quad (1)$$

with,  $Z_j(t) = a_j(t) e^{j\theta_j(t)}$   $j=1,2,3$  the complex envelope of the three carrier frequencies  $f_1, f_2$  and  $f_3$ .

In our case the objective is to lower the frequency bandwidth of the converted signals to relax the required performances of the Analog to Digital converter (ADC).

The strategy is consequently to convert the three frequency bands of the RF signal to Zero Intermediate Frequency (ZIF) for one, Low Intermediate Frequency (LIF) at frequency  $\Delta f_2$  for the second one and LIF at frequency  $\Delta f_3$  for the third.

In order to obtain these IF signals, the three CW frequencies of the LO signal are equal to  $f_1$ ,  $f_2 - \Delta f_2$  and  $f_3 - \Delta f_3$  with  $\Delta f_2 > BW_1/2$  and  $\Delta f_3 > BW_2/2 + \Delta f_2$ . Thus the expression of the LO signal is expressed as follows:

$$v_{LO}(t) = \text{Re}[V_{LOi}e^{j(2\pi f_1 t + \phi_{i1})} + \sum_{j=2}^3 V_{LOi}e^{j(2\pi(f_j - \Delta f_j)t + \phi_{ij})}] \quad (2)$$

with  $V_{LOi}$ , the amplitude of the CW signals and angles  $\phi_{ij}$ , the phase shifts between LO and RF signals and  $i$  and  $j$  represent respectively the number of RF paths of the demodulator and of the RF signal frequency bands.

If the low-pass filter at the output of the mixer has a cutoff frequency:

$$f_{LPF} = \Delta f_3 + BW_3 / 2 \quad (3)$$

and that the following conditions are fulfilled:

$$\begin{cases} f_3 > f_2 > f_1 \\ |f_2 - f_1| > f_{LPF} \\ |f_3 - f_1| > f_{LPF} \\ |f_3 - f_2| > f_{LPF} \end{cases} \quad (4)$$

The output signal of the mixer  $k$  of the demodulator is expressed as:

$$v_k(t) = LPF \{v_{LO}(t)v_{RF}(t)\} = V_{LOk} \left\{ \begin{aligned} &A_{k1}a_1(t) \cos(\theta_1(t) - \phi_{k1}) + \\ &\sum_{j=2}^3 A_{kj}a_j \cos(\theta_j + 2\pi\Delta f_j t - \phi_{kj}) \end{aligned} \right\} \quad (5)$$

where  $A_{kj}$ ,  $j=1,2,3$  are gains that include the conversion gain of the mixer and the losses of splitters, phase shifters and filters.

Regarding conditions (4) the six unwanted intermodulation products between RF signals and LO signals are eliminated.

The equation (5) proves that the first frequency band is transposed directly to baseband around zero, it is a ZIF demodulation. The second band is transposed to the intermediate frequency  $\Delta f_2$ , it is the first LIF demodulation. And the third band is transposed to the intermediate frequency  $\Delta f_3$ , it is the second LIF demodulation.

Moreover the separation between the three baseband spectrums is possible if:

$$\begin{cases} \Delta f_2 - BW_2 / 2 > BW_1 / 2 \\ \Delta f_3 - BW_3 / 2 > \Delta f_2 + BW_2 / 2 \end{cases} \quad (6)$$

### III. EXPERIMENTAL RESULTS

#### A. Description of the test bench

The Fig. 1 presents the measurement bench. Three sources E8267 (Agilent Technologies) generate modulated signals of carrier frequencies 2 GHz, 2.3 GHz and 2.6 GHz. These signals are added by a 3-way combiner (Anaren 043020). The output signal of the combiner is the RF signal aggregated in frequency bands. The  $I(p)$  and  $Q(p)$  numerical data are generated from a PC using Matlab software. The numerical frame is composed of a 16 symbols training sequence with Constant Amplitude Zero Autocorrelation (CAZAC) followed by a Pseudo Noise (PN9) data sequence. The carrier frequencies are modulated in different modulation format QPSK (Quadrature Phase Shift Keying), 8PSK (8-ary phase shift keying) or 16QAM (16 Quadrature amplitude modulation). However the modulation format is always QPSK in the case of the CAZAC sequence as the required signal to noise ratio is lower for this modulation format. Each numerical frame is filtered by a Square Root Raised Cosine filter (SQRC) with a roll-off equal to 0.35 which will be used also at the reception.

The filtered numerical frames are sent to the E8267 generators that operate in the mode ARB (arbitrary waveform generator) via the Local Area Network (LAN) constituted of a HP J2600A HUB.

On the other hand, the LO dedicated to the down conversion of the frequency aggregated RF signal have to be designed. According to II, we need to know the bandwidth of the three modulated signals. In this demonstration, the symbol rate is low (100

kS/s) and is fixed by the components performances of the test bench (Low Frequency signal amplifier, data acquisition card, PC ...). To fulfill the condition (6), the lower frequency band centred to 2 GHz is down converted to ZIF and both upper frequency bands centred respectively to 2.3 GHz and 2.6 GHz are transposed to LIF around 200 KHz and 400 KHz. So the required LO signal is a combination of three CW signals of frequencies 2 GHz, 2.2998 GHz and 2.5996 GHz. In this experience, the power levels of CW signals are identical and equal to 7dBm. These three signals are respectively delivered by 3 sources (Agilent E4431B, Anritsu MMG369B and HP4432B). All these sources are synchronized by using the same clock signal at frequency 10 MHz.

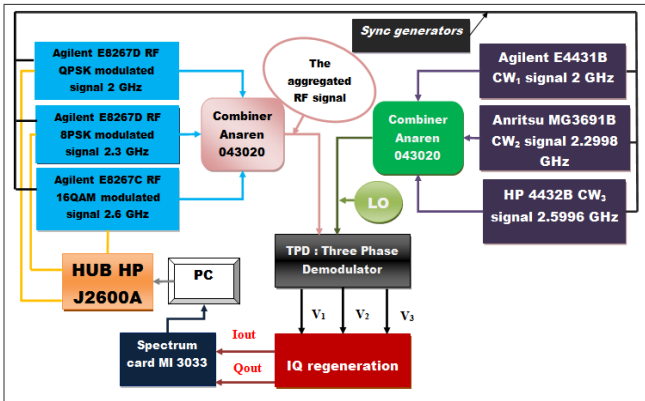

Fig. 1 Test Bench for the demodulation of RF signal aggregated in frequency.

The RF and LO signals is applied to the inputs of a Three Phase Demodulator (TPD) instead of the Classical In phase and Quadrature (CIQ) demodulator. Indeed, a previous paper [7] has shown TPD gives a gain of 20 dB in second-order inter-modulation distortion (IMD2) rejection in comparison with CIQ. The operation mode of TPD differs from the CIQ. The RF and LO signals are divided into three paths instead of two. The phase shift between the LO signals is equal to  $\pm 120^\circ$  for the TPD instead of  $90^\circ$  for the CIQ. The CIQ delivers directly the IQ baseband signals. In the case of the TPD, the output signals are three low frequency signals, named  $V_1(t)$ ,  $V_2(t)$  and  $V_3(t)$ . The TPD (Fig. 2) was essentially realized using COTS components. The phase shifters were made with microstrip propagation lines. The phase shift varies from  $60^\circ$  to  $150^\circ$  in function of frequency in the range 2 to 4.2 GHz. The splitters insertion loss is 5

dB. The mixers present the following characteristics: RF/LO inputs (2-7 GHz), FI output ( $DC-1.3$  GHz), LO power (7dBm), Conversion Loss (7dB) and intercept point of order 2 ( $IIP2 = 27$ dBm).

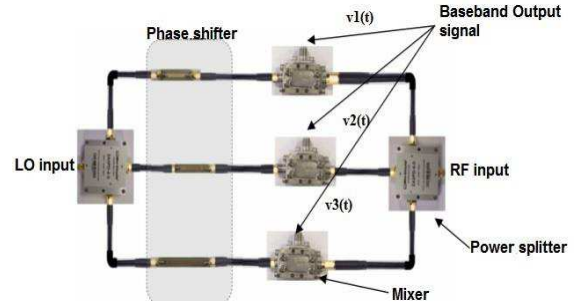

Fig. 2 Three Phase Demodulator

[8], [9] demonstrate that if  $V_2(t)$  output is symmetric in comparison with 2 others, the three output signals of the TPD can be added by an analog circuit of IQ regeneration (Fig. 3) performing the following operations:

$$I_{out}(t) = \mu_I \cdot [-V_1(t) + 2 \cdot V_2(t) - V_3(t)] \quad (7)$$

$$Q_{out}(t) = \mu_Q \cdot [V_1(t) - V_3(t)] \quad (8)$$

Both  $\mu_I$  and  $\mu_Q$  constants are determined by a classical equalization procedure.

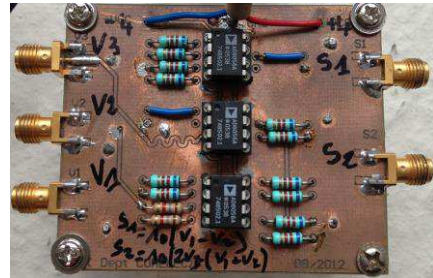

Fig. 3 Circuit of IQ regeneration

The sampling frequency of the  $I_{out}$  and  $Q_{out}$  data (Spectrum data acquisition card MI3033) is equal to 1 MHz. The numerical data contain a mix of the information spread over 3 discontinuous frequency bands. A step of separation of the three bands is performed by a digital filter. Then equalization of  $I_{out}$  and  $Q_{out}$  data is performed using the CAZAC training sequence. Finally the transmitted  $I(t)$  and  $Q(t)$  signals are recovered.

#### B. Measurement results

The spectrum of the baseband  $I_{out}$  signal shows we obtain three different spectrums in baseband centered respectively between 0-67.5 KHz (ZIF configuration), 133-267 KHz (first LIF configuration) and 333-467 KHz (second LIF configuration) (Fig. 4).

In the case where the 3 carrier frequencies are modulated in QPSK format, Fig. 5 shows the three demodulated QPSK constellations are recovered and centred. The power level for each band of the RF signal was equal to -30 dBm. The red points show that the synchronization CAZAC sequence functions correctly.

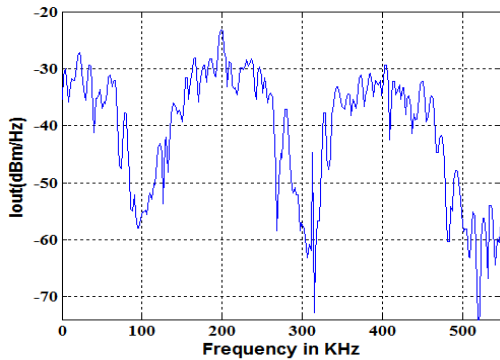

Fig. 4 Power Spectral Density in dBm/Hz of  $I_{out}$  signal in function of frequency in kHz.

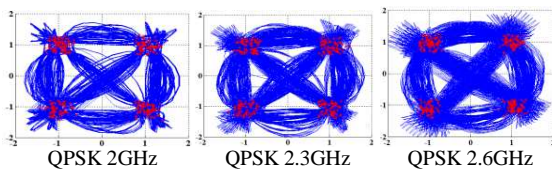

Fig. 5 Phase constellation of 3 discontinuous frequency bands RF signal with all modulated in QPSK translated to Zero-IF, 200 KHz LIF and 400 KHz LIF.

The performance of the demodulation is measured by the Error Vector Measurement (EVM) metric in function of the input power level of the RF signal (Fig. 6). These results show that more the IF frequency is close to zero frequency more EVM value is high. This can be explained by second-order inter-modulation distortion (IMD2). These spurious signals degrade more the ZIF converted band than both the LIF ones.

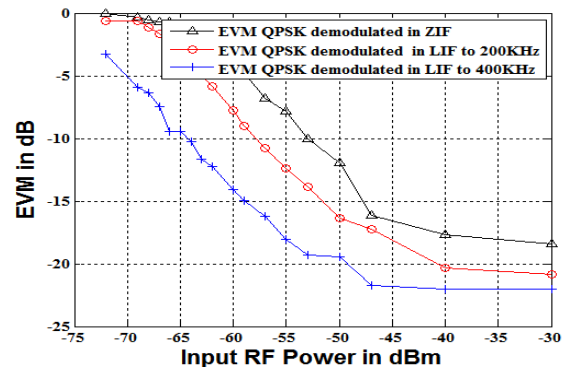

Fig. 6 EVM in dB in function of RF input power level in dBm of the RF signal constituted of 3 carriers QPSK modulated.

Next, modulations QPSK, 8PSK and 16 QAM respectively were applied to signal carrier frequencies 2 GHz, 2.3 GHz and 2.6 GHz. For the same power level of -30 dBm for each frequency band of the RF signal three IQ constellations were measured. Fig. 7 shows that the symbols are centred and synchronized. As previously, the measured value of EVM of the signal demodulated in ZIF is higher than (Fig. 8) those in LIF.

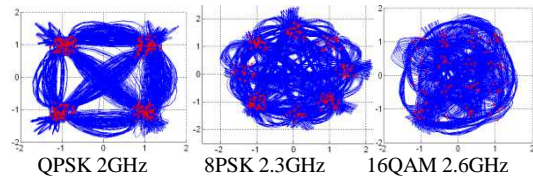

Fig. 7 Phase constellation of 3 discontinuous frequency bands RF signal with QPSK, 8PSK and 16 QAM modulations.

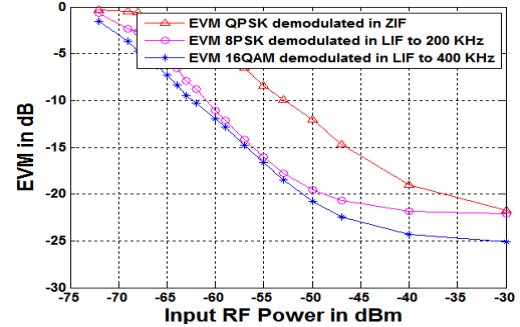

Fig. 8 EVM in dB in function of RF input signal in dBm constituted of 3 carriers modulated by QPSK, 8PSK and 16QAM signals.

Finally we realized the mixing of a RF signal constituted of three carrier bands unmodulated with a LO signal whose CW signals are shifted to 0 Hz, 200 Hz and 400 Hz compared to the aggregated frequency bands. In this measurement, the RF signal is constituted that CW signals at the frequency 2 GHz, 2.3 GHz and 2.6 GHz. The

spectrum of the baseband  $I_{out}$  signal is presented in Fig. 9.

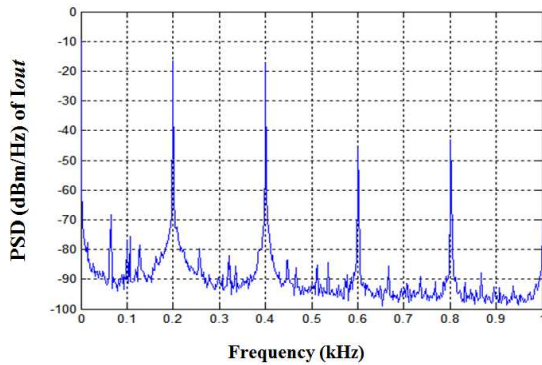

Fig. 9 Power Spectral Density in dBm/Hz of the baseband  $I_{out}$  signal in function of frequency in kHz.

The result of the Fig. 9 shows that if the IF frequency is close to zero frequency, the intermodulation products are more significant. This may be an explanation for the deterioration of the demodulated signal in ZIF than those demodulated in LIF, although the level of spurious lines is low.

#### IV. CONCLUSION

The technique presented in this paper makes it possible to demodulate a frequency aggregated RF signal with a single chain Rx. The RF signal was constituted of three discontinuous carrier frequencies modulated with the same modulation QPSK, or different modulations QPSK, 8PSK and 16QAM. The bandwidth of the down converted RF signal is limited to the interval (0, 500 KHz) that makes possible to use low cost ADC. In the case of a classical structure using a mono-ton LO signal the frequency bandwidth of the signal to sample would be (0, 600 MHz). This technique represents a good alternative in term of cost and volume to the usual one which uses as much of receiver Rx as the number of frequency band of the RF signal. The measurement results of the spectrums of the down converted signals, constellation and EVM validate the proposed theoretical method. In addition, our results also confirm that the signal demodulated in LIF configuration is less damaged than the signal demodulated in ZIF. Soon, the solution will be generalized and applied to  $n$  bands with high bandwidth of modulation according to the requirements of LTE-A.

#### ACKNOWLEDGMENT

We thank the Islamic Development Bank (IDB) for its financial support.

#### REFERENCES

- [1] Zukang Shen, Aris Papasakellariou, Juan Montojo, Dirk Gerstenberger and Fangli Xu: "Overview of 3GPP LTE Advanced Carrier Aggregation for 4G Wireless Communications," IEEE Commun. Mag., Feb. 2012, pp. 112-130.
- [2] Guangxiang Yuan, Xiang Zhang; Wenbo Wang; Yang Yang, "Carrier aggregation for LTE advanced mobile communication systems" IEEE Commun. Mag., Feb. 2010, pp. 88-93.
- [3] Najah Abu Ali, Abd-Elhamid M. Taha and Hossam S. Hassanein, « LTE, LTE-ADVANCED AND WIMAX », ISBN-13: 9780470745687, Wiley; 1 edition (November 15, 2011).
- [4] Stephen Wu and Behzad Razavi: "A 900-MHz/1.8-GHz CMOS Receiver for Dual-Band Applications," IEEE J. Solid-State Circuits, Vol. 33, pp. 2178-2185, Dec. 1998.
- [5] Kitayabu T., Ikeda Y.: "Implementation of Concurrent Dual-Band Receiver Using IF Undersampling", Radio and Wireless Symposium (RWS), 2011 IEEE.
- [6] Kaho, T.; Yamaguchi, Y.; Shiba, H.; Akabane, K.; Uehara, K.; Araki, K, "A simultaneous receiving multi-band mixer with independent gain control", Microwave Conference Proceedings (APMC), 2011 Asia-Pacific, 5-8 Dec. 2011, Melbourne, VIC, pp. 383 - 386
- [7] K. Mabrouk, F. Rangel, B. Huyart and G. Neveux: "Architectural solution for second-order intermodulation intercept point improvement in direct down-conversion receivers", IET Microw. Antennas Propag., vol. 4, n° 9, pp. 1377-1386, Sept 2010.
- [8] C. de la Morena-Álvarez-Palencia, K. Mabrouk, B. Huyart, A. Mbaye, M. Burgos-García: "Direct Baseband I-Q Regeneration Method for Five-Port Receivers Improving DC-offset and Second-Order Intermodulation Distortion Rejection", IEEE Trans. on Microwave Theory & Techniques, Aug. 2012, vol. 60, n° 8, pp. 2634-2643.
- [9] K. Mabrouk, B. Huyart and G. Neveux: "3-D Aspect in the Five-Port Technique for Zero-IF Receivers and a New Blind Calibration Method", IEEE Trans. On MTT, June 2008, Vol. 56, pp 1389- 1396.