



**HAL**  
open science

## A time domain model of background noise for inhome PLC networks

Rehan Hashmat, Pascal Pagani, Thierry Chonavel, Ahmed Zeddami

► **To cite this version:**

Rehan Hashmat, Pascal Pagani, Thierry Chonavel, Ahmed Zeddami. A time domain model of background noise for inhome PLC networks. *IEEE Transactions on Power Delivery*, 2012, 27 (4), pp.2082 - 2089. 10.1109/TPWRD.2012.2207744 . hal-00945376

**HAL Id: hal-00945376**

**<https://hal.science/hal-00945376>**

Submitted on 14 Feb 2014

**HAL** is a multi-disciplinary open access archive for the deposit and dissemination of scientific research documents, whether they are published or not. The documents may come from teaching and research institutions in France or abroad, or from public or private research centers.

L'archive ouverte pluridisciplinaire **HAL**, est destinée au dépôt et à la diffusion de documents scientifiques de niveau recherche, publiés ou non, émanant des établissements d'enseignement et de recherche français ou étrangers, des laboratoires publics ou privés.

# A Time-Domain Model of Background Noise for Inhome MIMO PLC Networks

R. Hashmat, P. Pagani, T. Chonavel and A. Zeddami

**Abstract—** Multiple-Input Multiple-Output (MIMO) techniques have recently become an important research field for enhancing the performance of in-home Power Line Communication (PLC) systems by exploiting the additional Protective Earth wire. The development of such systems requires an accurate description of the channel noise. In this paper we have presented a model for PLC background noise based on an extensive set of measurements. We have adopted the framework of multivariate time series to model the PLC background noise. This paper employs the Vector Autoregressive (VAR) modeling technique to extract noise model parameters from the measured noise. We have verified the accuracy of the noise model by comparing time and frequency domain correlation of measured and modeled noises.

**Keywords-** Power Line Communications, Multiple Input Multiple Output MIMO, Background Noise Model, Multivariate Analysis, Vector Autoregressive Model

## I. INTRODUCTION

Power Line Communications consists of delivering information over electrical cables. PLC benefits from the ubiquity of already existing electrical power delivery networks and promises access to telecom services in every corner of a house without requiring installation of new infrastructure. Having started from very low bit rate applications, over a span of several decades PLC has emerged as a potential competitor for broadband communications systems [1] [2].

The inhome electrical wiring consists of three wires: Phase (P), Neutral (N) and Protective Earth (PE). The conventional PLC systems work on Single-Input Single-Output (SISO) principle as they use only the P-N port obtained from P and N wires to transmit and receive the signals. Recently, an increasing interest in MIMO PLC systems has been observed. MIMO techniques have proved their advantages in radio and wireless communications. An increased capacity of PLC systems by the utilization of MIMO techniques is reported in [4]-[6]. In order to take advantage of MIMO techniques for PLC it is necessary to study and model MIMO PLC channel

which consists of channel transfer function (CTF) and channel noise. A CTF model for MIMO PLC channels has been proposed in [16].

Channel noise modeling is a challenge which requires intensive research and considerable amount of measurement work. For SISO PLC systems, some noise models, of background noise and impulsive noise, have already been presented in research works [8]-[12]. Channel background noise has been modeled mostly in the frequency domain [3] [11]. Generally, the spectrum of the measured noise is fitted to a decreasing exponential function [14]. The emergence of MIMO PLC prompted the research on PLC channel noise in MIMO context. The MIMO PLC channel background noise characterization was discussed for the first time in [13]. A frequency domain model of background noise for MIMO PLC channel has been presented in [17].

In this paper we present an extensive time-domain MIMO power line (PL) noise measurement campaign performed in five houses. From the modeling point of view, although it is interesting to model the spectrum of background noise, for MIMO PL noise it is not enough. The MIMO PL noise consists of three noise sequences which exhibit mutual correlations. The MIMO PL noise model should be able to capture such correlations. This paper proposes for the first time a comprehensive MIMO PL background noise model. We have used a framework based on multivariate analysis, and the vector autoregressive (VAR) technique is employed to model the MIMO PL noise in time-domain.

The contents of this paper are in following order. Section II describes the noise measurements on domestic MIMO PLC networks, Section III demonstrates the characterization of MIMO PL noise, Section IV presents MIMO PL noise model and finally some conclusions are drawn in Section V.

## II. MEASUREMENTS OF MIMO PL NOISE

MIMO communication is used in systems equipped with multiple transmission and reception antennas or ports. MIMO techniques efficiently exploit various diversities and offer improved system performance.

### A. MIMO Model of an inhome PL network

For a MIMO system comprising of  $M$  emitter ports and  $N$  receiver ports, the channel matrix  $\mathbf{H}(f)$  can be written as shown in Eq. 1,

Manuscript received on November 16, 2011.

R. Hashmat, P. Pagani and A. Zeddami are with the Orange Labs, Lannion FRANCE.

e-mail: rehan.hashmat@orange.com, pascal.pagani@orange.com, ahmed.zeddami@orange.com

R. Hashmat, T. Chonavel are with department of signals and communications, Telecom Bretagne, CNRS LABSTICC-UMR 3192, Brest FRANCE.

e-mail: thierry.chonavel@telecom-bretagne.eu

$$H(f) = \begin{bmatrix} h_{1,1}(f) & h_{1,2}(f) & \cdots & h_{1,M}(f) \\ h_{2,1}(f) & h_{2,2}(f) & \cdots & h_{2,M}(f) \\ \vdots & \vdots & \ddots & \vdots \\ h_{N,1}(f) & h_{N,2}(f) & \cdots & h_{N,M}(f) \end{bmatrix} \quad (1)$$

where  $h_{nm}(f)$  represents the complex channel transfer coefficient from the  $m^{\text{th}}$  emitter to the  $n^{\text{th}}$  receiver, at a frequency  $f$ . Transmission channels represented by  $h_{n,m}$  with  $m=n$  are called co-channels, and those represented by  $h_{n,m}$  with  $m \neq n$  are called cross-channels. The distinction between co- and cross channels is important in MIMO realization of PLC networks because a direct link between receive and transmit ports is always present.

The idea for MIMO signal transmission in PLC networks arises from the fact in most developed countries the domestic electrical wiring consists of three wires: Phase (P), Neutral (N) and Protective Earth (PE). The conventional PLC systems work on Single-Input Single-Output (SISO) principle as they use only the P-N port obtained from P and N wires to transmit and receive the signals. If the unused PE wire is utilized, the three wires can form three ports P-N, P-PE and N-PE to create the analogy of a 3x3 MIMO configuration as shown in Fig. 1. However, due to Kirchhoff's law, only two input ports can be used simultaneously. For all practical purposes, one has to extract any 2x2 or 2x3 MIMO configurations.

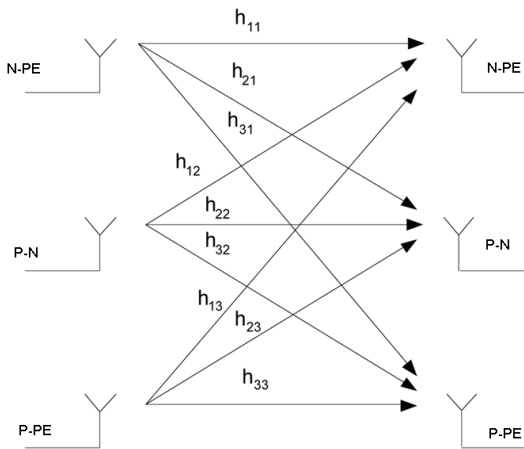

Figure 1. A 3x3 MIMO analogy of an inhome PLC MIMO channel

### B. Measurement of MIMO PL noise

This sub-section presents a MIMO PLC channel noise measurement campaign. This campaign has been described in [13] and we present it here in more detail for the sake of completeness. Five houses were selected for measurements in a semi urban area at Lannion, France. The electrical wiring in new houses generally has the PE wire but in older houses PE wire is often absent. Therefore, the measurements were performed only in those houses which are equipped with PE

wire in electrical wiring circuits. The houses were selected to represent a good mix of characteristics like age, size and the number of floors. The location of a house is also important. Different locations offer different electromagnetic noise environment, particularly the narrow band noise which is generated primarily by the local radio transmission services. The selected houses are good examples of real life scenario because they are equipped with all the appliances and electrical loads that one finds in common houses. The MIMO PL noise consists of three noise sequences: P-N, N-PE and P-PE. Noise was measured on 27 sockets. Fig. 2 shows the schematic diagram of MIMO noise measurement setup.

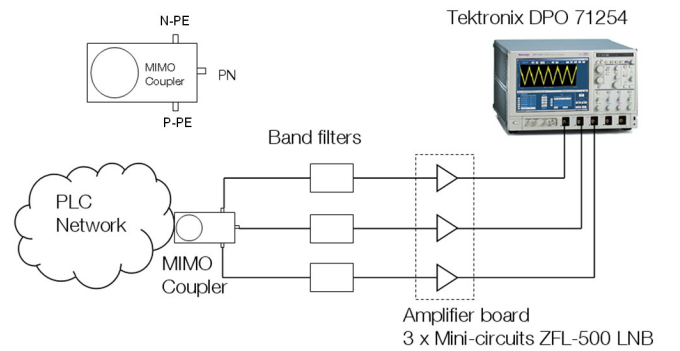

Figure 2. MIMO PL noise measurement setup

It should be noted that the inhome PLC network is connected to 230 volts, single phase AC mains. Therefore, for the protection of the measurement equipment it is necessary to block the AC mains. The MIMO PLC coupler performs this function. A schematic block diagram of a MIMO PLC coupler is shown in Fig.3.

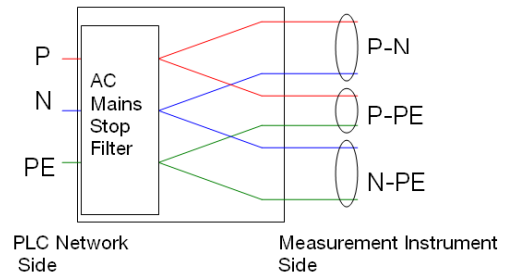

Figure 3. A Simplified block diagram of a MIMO PLC coupler

The measurements were performed at a sampling frequency of 1.25 Gsamples/second over a period of 20 ms which corresponds to the period of one complete cycle of 50 Hz, 230 V AC mains. The band filters consisted of three 2-500 MHz high pass filters and three FM notch filters. The FM notch filters have a typical attenuation of 20-35 dB over the 88-108 MHz band. Although the three amplifiers are optional we needed them throughout the measurement campaign for better resolution of stored data. The amplifiers have typical gain of

28 dB over 2-500 MHz band and need +15 volts and 60 milli Amperes for biasing. Some particular precautions were taken to ensure clean and uncontaminated capture of noise samples. For example, for avoiding the radiated interference, we used short (1 meter length), shielded SMA cables to connect the MIMO coupler with the oscilloscope. The oscilloscope and amplifiers' biasing power supply were plugged into the 230 volts AC mains through a filtered power cable to prevent the conducted interference from the electrical wiring enter the measurement devices.

The instrument used for MIMO PLC channel noise measurement is a high performance multi channel digital oscilloscope. In a single shot, with the settings mentioned above, MIMO PLC noises N-PE, PN, and P-PE of a given reception socket are captured and stored. Fig. 4 shows typical MIMO PLC channel noise.

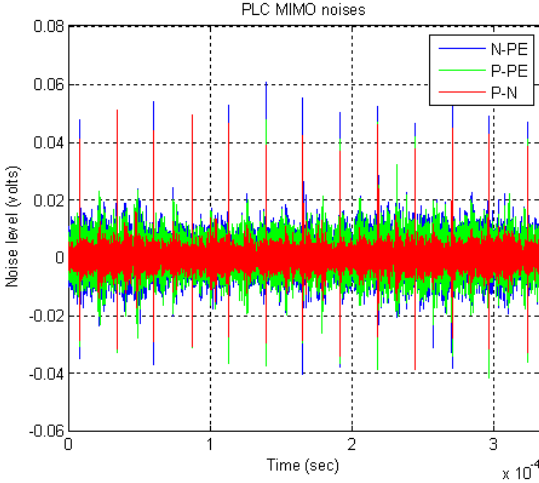

Figure 4. Typical MIMO PLC noise (time domain)

### III. CHARACTERIZATION OF MIMO PL NOISE

In this section MIMO PL noise characterization is presented. We characterize the channel noise by a time series and some additional parameters. Generally in the PLC literature, for background noise, a frequency domain approach has been followed where the emphasis is on characterizing the spectrum of measured noise. Existing noise characterization efforts encompass only SISO channels. MIMO PLC channel noise characterization is an untouched area. Some results on MIMO PLC noise were presented by the authors for the first time in [17].

#### A. Multivariate Time Series

Let us visualize the MIMO PLC channel noise as a tri-variate time series (TTS), which is a special case of a multivariate time series (MTS). A time series  $\{x_i\}$  is a sequence of data values measured at equally spaced time intervals  $\Delta t$ . A MTS consists of simultaneous observations of

several variables. Consider a MTS  $\{N_i\}$  with  $n$  variables such that  $N_i = (x_{1i}, \dots, x_{ni})^T$ .

MIMO PLC channel noise as shown in Fig. 4 can be characterized as a MTS  $\{N_{MIMO,i}\}$  with  $n=3$ ,  $\Delta t=0.0033$   $\mu$ seconds, and where  $\{x_{1i}\}$ ,  $\{x_{2i}\}$  and  $\{x_{3i}\}$  represent N-PE, P-N and P-PE noises respectively. In the sequel, the  $\{N_{MIMO,i}\}$  is taken as 46.52  $\mu$ seconds which corresponds to OFDM symbol duration in HomePlug AV standard for commercial PLC devices [7].

#### B. Frequency Domain Cross-Correlation

Spectral properties of noise can be used for noise characterization. This method has been reported in [3], [13], [14]. In [3], based on measurements, the PSD of back ground SISO PLC noise is described as shown in Eq. 2.

$$N_{SISO}(f) = \frac{1}{f^2} + 10^{-15.5} \text{ mW/Hz} \quad (2)$$

Since MIMO PLC noise consists of three noises, therefore their spectra need to be observed individually. We find that general spectral form of MIMO PLC noise is of a decreasing exponential as shown in Fig. 5.

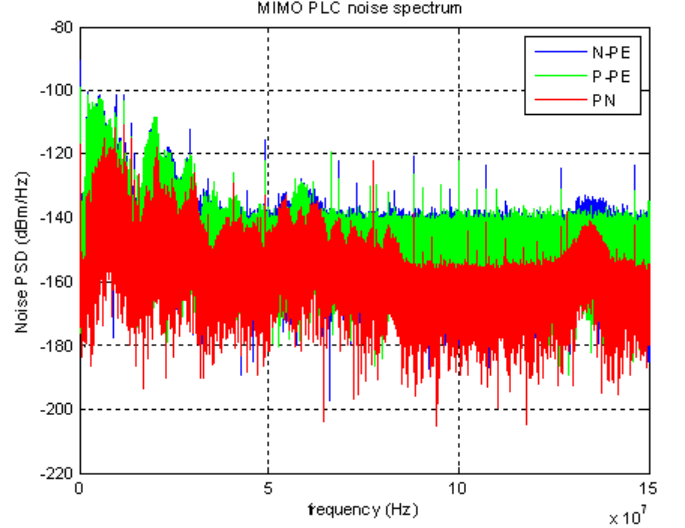

Figure 5. Typical spectra of measured MIMO PLC channel noises

Let us consider that the parameter  $\Psi_{i,j}$ , defined in Eq. 3, denotes frequency domain cross-correlation between measured P-N noise PSD and modeled P-N noise PSD (same applies to N-PE and P-PE noises as well).  $\Psi_{i,j}$  serves as a metric of spectral resemblance between measured and modeled noise.

$$\Psi_{i,j} = \frac{\overline{N_i(f)N_j^*(f)} - \overline{N_i(f)}\overline{N_j^*(f)}}{\sqrt{\left(\overline{|N_i(f)|^2} - \left|\overline{N_i(f)}\right|^2\right)\left(\overline{|N_j(f)|^2} - \left|\overline{N_j(f)}\right|^2\right)}} \quad (3)$$

where  $N$  represents the envelop of noise PSD in dBm/Hz, subscripts  $i$  and  $j$  stand for measured and modeled noise respectively and  $\overline{(\cdot)}$  denotes frequency domain average. High values of  $\Psi_{i,j}$  are desirable as it suggests that the PSD of modeled noise has a close resemblance to the PSD of measured noise and vice versa.

### C. Time-domain Cross-correlation

The time-domain cross correlation  $\rho_{i,j}$  between N-PE, P-N and P-PE noises is very important and it is defined in Eq. 4.

$$\rho_{i,j} = \frac{\overline{n_i(t)n_j^*(t)} - \overline{n_i(t)}\overline{n_j^*(t)}}{\sqrt{\left(\overline{|n_i(t)|^2} - \overline{n_i(t)}\overline{n_i^*(t)}\right)\left(\overline{|n_j(t)|^2} - \overline{n_j(t)}\overline{n_j^*(t)}\right)}} \quad (4)$$

where  $n$  denotes a noise sequence in time domain and  $\overline{(\cdot)}$  represents the time domain average.

A variant of  $\rho_{i,j}$  is  $\rho_{meas,i,j}$  which stands for measured noise. In the next sub-section, we will discuss another variant of  $\rho_{i,j}$  denoted by  $\rho_{VAR,i,j}$  which signifies time-domain cross-correlation for noise generated by Vector Autoregressive (VAR) model. After analyzing the measurements we observe that there is a stronger correlation  $\rho_{meas,i,j}$  between N-PE and P-PE noises, as shown in Fig. 6. To some extent N-PE and P-N are also correlated to each other, and the same applies to P-PE and P-N. The correlation behavior of MIMO PLC channel noise is quite different from MIMO wireless noise, as the noise in MIMO wireless channels is generally treated as uncorrelated unless for closely spaced antennas [15].

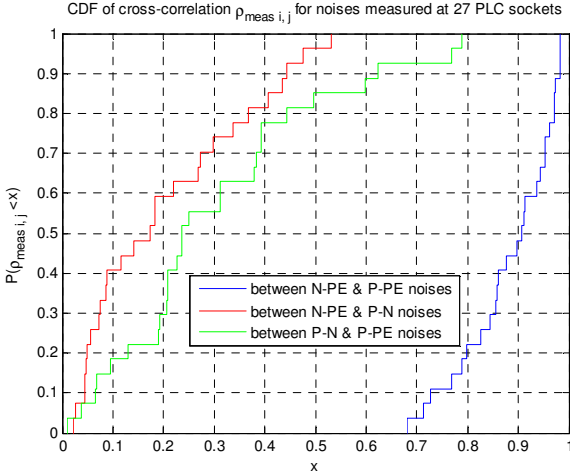

Figure 6. CDF of Time-domain cross-correlation  $\rho_{i,j}$  between MIMO PLC noises

### D. Frequency-domain root mean square error

The frequency domain root mean square error (RMSE), denoted by  $\varepsilon_{rms,f}$ , is defined in Eq. 5.

$$\varepsilon_{rms,f} = \sqrt{\frac{1}{k} \sum_{i=1}^k (N_i - N_j)^2} \quad (5)$$

where  $N_i$  and  $N_j$  represent a given MIMO PLC noise measurement and its VAR realization respectively, and  $k$  is the length of noise sequences. RMSE, like  $\rho_{i,j}$  and  $\Psi_{i,j}$ , is a parameter used to estimate the accuracy of VAR model. Low values of RMSE indicate a more accurate model and vice versa.

## IV. MIMO PL NOISE MODEL

### A. Vector Autoregressive Model

In this sub-section we present a new model for MIMO PLC channel noise. The goal is to generate a MTS which imitates the properties of the measured noise. The challenge is how to model this MTS so that the modeled  $\{\mathbf{x}_{1t}\}$ ,  $\{\mathbf{x}_{2t}\}$  and  $\{\mathbf{x}_{3t}\}$  not only have similar spectral characteristics but also the same cross-correlations as those of the measured MIMO PLC channel noise. As we are going to see, one method that can efficiently model the MIMO PLC channel noise is Vector Autoregressive (VAR) model.

A Vector Autoregressive (VAR) model is basically an autoregressive (AR) model in the multivariate context. Autoregressive models are often used to model and predict time series. The notation  $VAR(p)$  stands for a VAR model of order  $p$ . A  $VAR(p)$  model of a  $m$ -variate time series is defined as

$$\mathbf{x}_t = \mathbf{w} + \sum_{l=1}^p \mathbf{A}_l \mathbf{x}_{t-l} + \boldsymbol{\varepsilon}_t, \quad \text{cov}(\boldsymbol{\varepsilon}_t) = \mathbf{C} \quad (6)$$

where  $\mathbf{x}_t \in \mathfrak{R}^m$  are the vectors representing the MTS at a given time instant  $t$ .  $\boldsymbol{\varepsilon}_t$  are zero-mean, uncorrelated random noise vectors.  $\mathbf{C} \in \mathfrak{R}^{m \times m}$  is the noise covariance matrix and  $\mathbf{A}_1, \dots, \mathbf{A}_p \in \mathfrak{R}^{m \times m}$  are model coefficient matrices. The vector  $\mathbf{w} \in \mathfrak{R}^m$  serves to introduce mean value if the MTS has non-zero mean [14].

Equation 6 serves a two-fold purpose. This equation is used to extract a  $VAR(p)$  model from noise measured at a given socket. Such a VAR model consists of  $\mathbf{A}_1, \dots, \mathbf{A}_p, \mathbf{C}$  and  $\mathbf{w}$ . We denote it by  $VAR(p)_{socket}$  as this model is associated to a given socket for a given order  $p$ . Once  $VAR(p)_{socket}$  is obtained, MIMO PLC noise can be generated for that particular socket and order by using Eq. 6.

#### 1) Order Selection of VAR Model

As mentioned in section VI.A, frequency domain cross-correlation  $\Psi_{i,j}$  and time-domain cross-correlation  $\rho_{i,j}$  are used for noise characterization. Therefore, we look for a  $VAR(p)_{socket}$  model which can satisfactorily achieve cross correlation  $\rho_{VAR,i,j}$  so that  $\rho_{VAR,i,j}$  is close to  $\rho_{meas,i,j}$ . For this

purpose we study the variation of  $\rho_{VAR,ij}$  w.r.t.  $p$ . This procedure was applied to 27 measured MIMO PLC noises. It can be observed in Fig. 7 that as  $p$  varies,  $\rho_{VAR,ij}$  remains almost constant. Although this result does not help much for order selection of VAR model, it demonstrates that VAR modeling approach is capable of achieving similar values of  $\rho_{ij}$  as the measured data.

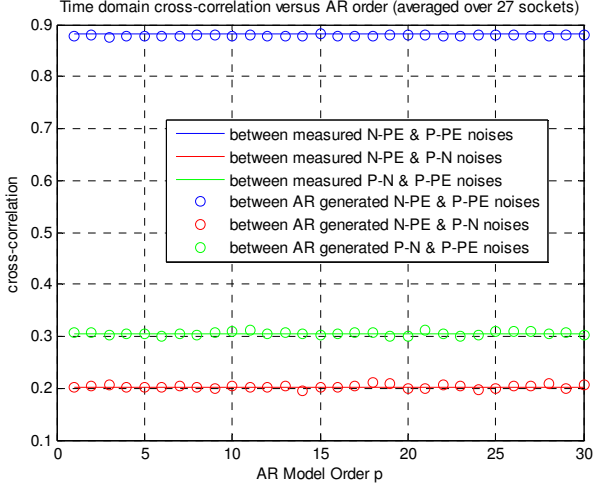

Figure 7. Time-domain cross-correlation versus VAR model order

Next the spectral resemblance between measured MIMO PLC channel noise and its VAR realization  $VAR(p)_{socket}$  is studied. We calculate the root mean square error (RMSE) and cross-correlation  $\Psi_{ij}$  between the spectra of a measured noise and  $VAR(p)_{socket}$  realization for different  $p$ . It can be seen in Fig. 8 (a) that RMSE initially decreases sharply as the VAR order increase, but later the rate of fall reduces.

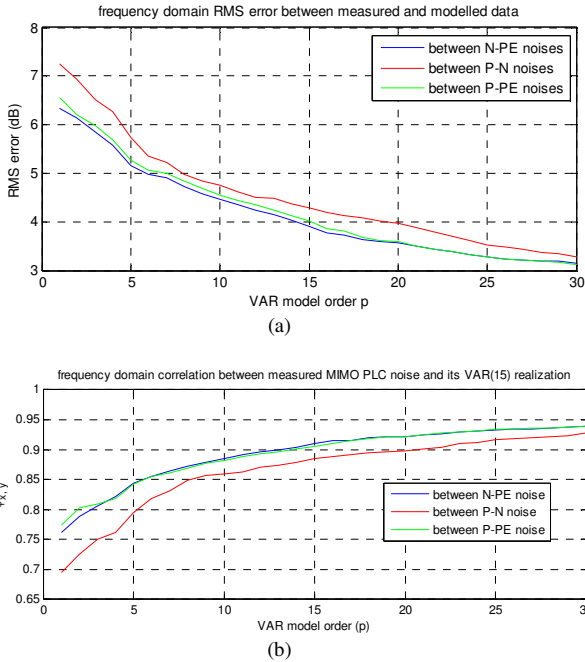

Figure 8. Relationship between frequency domain RMS error and VAR order (a). Relationship between frequency domain cross-correlation and VAR model order (b).

The dependence of  $\Psi_{ij}$  on VAR order is even more evident as we see in Fig. 8 (b) that  $\Psi_{ij}$  initially increase sharply as  $p$  increases but then tapers off. So, we select VAR(15) to model MIMO PLC noise as a compromise between accuracy and complexity.

## 2) Extraction of VAR(15) Model

Once the order of the VAR model is selected as  $p=15$ , the next step is the extraction of model parameter from measured data. We observe in Fig. 4 that measured data has zero mean, therefore,  $\mathbf{w}$  can be taken as a null vector. Now, according to Eq. 6, the problem of model extraction reduces to the estimation of matrices  $\mathbf{A}$  and  $\mathbf{C}$  which are  $3 \times 45$  and  $3 \times 3$  matrices respectively. Estimation methodology of  $\mathbf{A}$  and  $\mathbf{C}$  has been elaborated in [14]. It should be noted here that matrices  $\mathbf{A}$  and  $\mathbf{C}$  are real valued. Since we had measured data at 27 PLC sockets so we end up with 27  $\mathbf{A}$  and 27  $\mathbf{C}$  matrices. From here onward one may try some method to find a generalized form of  $\mathbf{A}$  and  $\mathbf{C}$ . However, the pool of 27 samples is not rich enough to provide a reliable statistical trend. Keeping this in view an average model may be a good choice. So, eventually we are left with one  $\mathbf{A}$  and one  $\mathbf{C}$  matrix which are arithmetic means of 27  $\mathbf{A}$  and  $\mathbf{C}$  matrices respectively. This can be termed as  $VAR(15)_{avg}$  model. (The average  $\mathbf{A}$  and  $\mathbf{C}$  matrices can be denoted with  $\mathbf{A}_{avg}$  and  $\mathbf{C}_{avg}$ . An element  $c_{row,col}$  of  $\mathbf{C}_{avg}$  is arithmetic mean of  $c_{row,col}$  elements of 27  $\mathbf{C}$  matrices. (Same applies to  $\mathbf{A} = \mathbf{A}_1 \dots \mathbf{A}_p$ ).

## 3) Generating the MIMO PLC channel noise

MIMO PLC channel noise can be generated with the help of above mentioned  $VAR(15)_{avg}$  model. Fig. 9 shows a typical noise sequence measured at a given socket. The record length is approximately equal to one OFDM symbol's duration. Fig. 10 depicts the noise generated by  $VAR(15)_{avg}$  model.

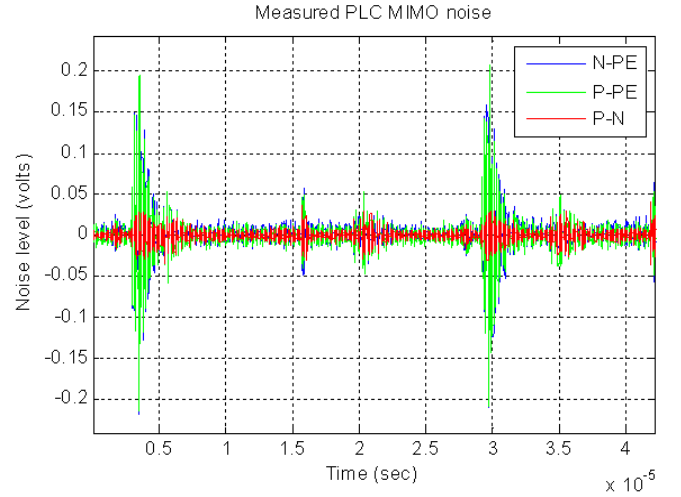

Figure 9. Typical measured MIMO PLC channel noise (duration  $\approx$  one OFDM symbol)

Clearly, the two figures do not resemble each other. We can observe distinct peaks in the measured noise while they are absent in modeled noise. This suggests that VAR model is

unable to realize the distinct peaks which, in fact, represent the periodic impulsive noise. However, it can be noted that the overall envelop of modeled noise is larger than off-impulse parts of measured noise.

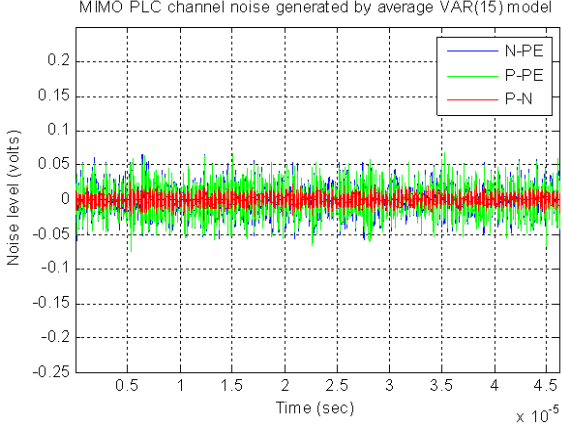

Figure 10. MIMO PLC noise generated by average  $\text{VAR}(15)_{\text{avg}}$  model (duration  $\approx$  one OFDM symbol)

Fig. 11 shows a good resemblance between spectral envelopes of measured and modeled noise, which suggests that the dissimilarity between Fig. 9 and Fig. 10 does not affect much in frequency domain.

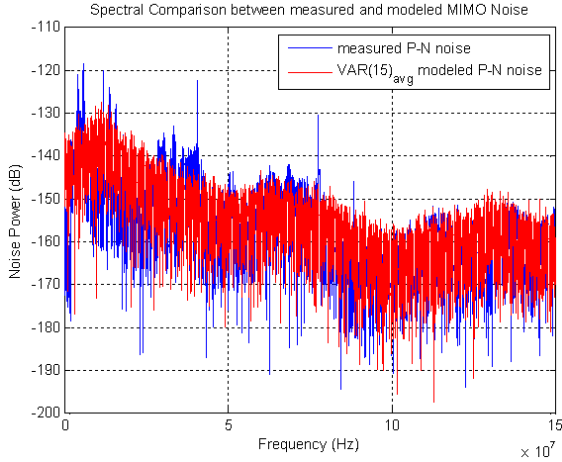

Figure 11. Spectral resemblance between measured and modeled MIMO PLC P-N noise

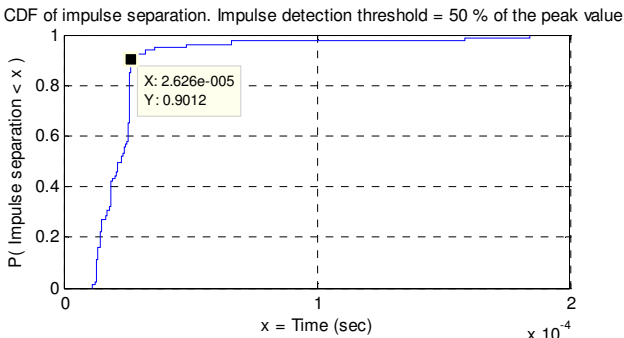

Figure 12. CDF of impulse separation between successive impulses in measured MIMO PLC noise

Here, an important question emerges: do we need to model the impulsive and non impulsive parts of measured MIMO PLC noise separately or not? To answer this question, we need to explore the periodicity of impulses. If impulses are separated by duration sufficiently longer than OFDM symbol period, one needs to model them separately. But if several impulses occur within a single OFDM symbol, then they raise the overall level of frequency domain background noise for each symbol and need not to be modeled separately. Fig. 12 shows the CDF of average time separation between successive impulses detected in  $27 \times 3 = 81$  measured noises. The threshold of impulse detection is set to 50% of the highest peak value of the measured noise. It can be observed that for 90 % of the measured noises, average time separation between successive impulses is  $26.4 \mu\text{seconds}$  or less. Stated otherwise, for 77 out of 81 noise measurements, the separation between two successive impulses is less than the OFDM symbol duration. Therefore, the impulses need not to be modeled separately and they are compensated by overall larger envelop of modeled background noise.

It should be noted that for some applications, for example single carrier communication, generation of impulses in the modeled noise may be necessary. Generation of impulses can be accomplished by detecting envelope of the measured noise and multiplying it with the modeled noise. Fig. 13 shows a measured noise sequence and its envelope in the impulse region.

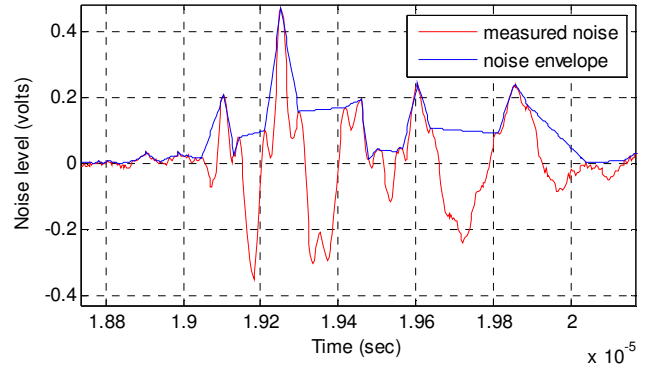

Figure 13. Measured noise sequence and its envelope in the impulse region

### C. Model Validation

The validity of the model can be verified through frequency domain cross-correlation and time domain cross-correlation. The MTS generated by  $\text{VAR}(15)_{\text{avg}}$  model should exhibit similar  $\Psi_{i,j}$  and  $\rho_{i,j}$  as the measured MIMO PLC channel noise.

#### 1) Time-domain cross-correlation

A comparison between  $\rho_{\text{meas},i,j}$  (averaged over 27 sockets) and  $\rho_{\text{VAR},i,j}$  obtained from  $\text{VAR}(15)_{\text{avg}}$  model is presented in table 1. It can be observed in table 1 that average  $\text{VAR}(15)_{\text{avg}}$  model achieves similar time-domain correlation as the measured MIMO PLC channel noise. The difference for N-PE & P-PE correlations is 4% and for P-N & P-PE is 1%. In N-PE & P-N case the difference is 18%, however, these correlations

are so low that N-PE and P-N can be regarded as uncorrelated anyhow.

Table 1. Time-domain correlation between MIMO PLC noises

	Between N-PE & P-N	Between N-PE & P-PE	Between P-N & P-PE
$\rho_{meas,i,j}$	0.20	0.88	0.30
$\rho_{VAR,i,j}$	0.02	0.92	0.31

## 2) Frequency Domain Cross-Correlation

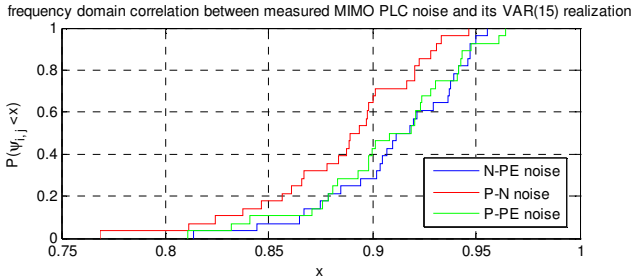

Figure 14. CDF of Frequency-domain correlation between measured and  $VAR(15)_{socket}$  generated MIMO PLC noises

Fig. 14 presents the CDF of frequency domain correlation between a given measured MIMO PLC noise and its  $VAR(15)_{socket}$  realization. Since  $VAR(15)_{socket}$  realization is pe-

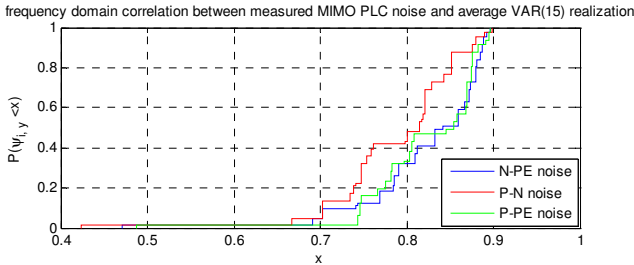

Figure 15. CDF of Frequency-domain correlation between measured and  $VAR(15)_{avg}$  generated MIMO PLC noises

-rinent to a given socket so it is expected to achieve higher  $\Psi_{i,j}$  than  $VAR(15)_{avg}$  realization. This effect is clearly visible in the CDFs of figures 14 and 15. However, the difference is not significant. For N-PE and P-PE noises,  $P(\Psi_{i,j}=0.5)$  corresponds to  $\Psi_{i,j}$  of 0.92 and 0.85, for  $VAR(15)_{socket}$  and  $VAR(15)_{avg}$  respectively. This amounts to a difference of 7%. Similarly, for P-N noise, the difference is 8%. It can be inferred that the  $VAR(15)_{avg}$  model can generate a noise which exhibits nearly similar spectrum as that of the measured MIMO PLC channel background noise.

## 3) Frequency Domain RMSE

The results for frequency domain RMSE are shown in figures 16 and 17. In Fig. 16, we note that  $\epsilon_{rms,f}$  between a given MIMO PLC noise measurement and its  $VAR(15)_{socket}$  realization ranges from 3 to 6 dB. Fig. 17 shows the CDF of

$\epsilon_{rms,f}$  between MIMO PLC noise measurement and  $VAR(15)_{avg}$  model. Here we note that for  $P(RMSE < 50\%)$ ,  $\epsilon_{rms,f}$  values vary between 4 and 6 dB. This is largely in agreement with the CDF of Fig. 27 for  $P(RMSE > 50\%)$ . However, in Fig. 17, as we move beyond  $P(RMSE = 50\%)$ ,  $\epsilon_{rms,f}$  ranges between 6 to 16 dB. It can be argued that  $\epsilon_{rms,f} > 12$  dB may be unacceptable (i.e. 6 dB or stated otherwise  $\pm 3$  dB more than the maxima of Fig. 27), but this is the price of the simplicity of  $VAR(15)_{avg}$  model. One method to reduce  $\epsilon_{rms,f}$  could be to select a higher order of VAR model.

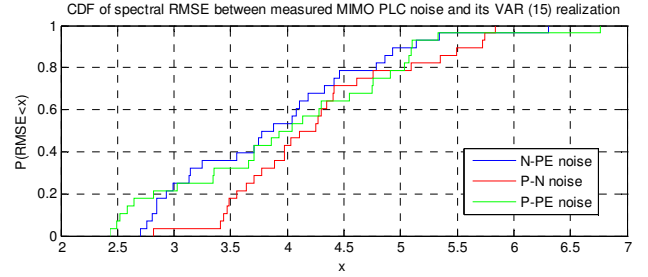

Figure 16. CDF of frequency domain RMSE between measured and  $VAR(15)_{socket}$  generated MIMO PLC noises

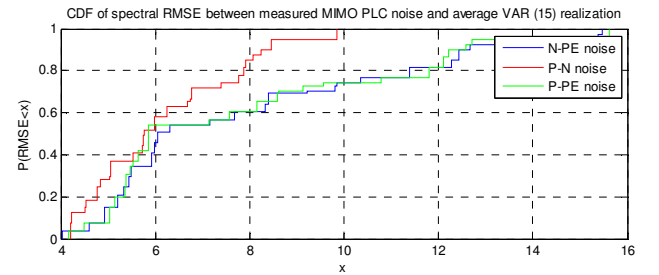

Figure 17. CDF of frequency domain RMSE between measured and  $VAR(15)_{avg}$  generated MIMO PLC noises

## V. CONCLUSIONS

In this paper we have presented for the first time a time-domain model of background noise for MIMO in-home PL channel, based on measurements performed in real-life domestic environment.

The proposed MIMO PLC channel noise model is based on a multivariate time series model. We have used the framework of Vector Autoregressive modeling to extract model parameters from measured MIMO PLC channel noise. The measured noises show that the MIMO PL noises exhibit correlation with each other. The primary motivation behind the noise model that we have devised in this paper is to replicate the mutual correlations. The model is verified by comparing time-domain and frequency domain cross-correlations between modeled and measured noises.

In the future, the model and simulation technique described in this work is expected to form the foundations of a complete digital communication model that will be used to assess the



performance of comprehensive MIMO PLC transmission systems.

## REFERENCES

- [1] P. A. Brown, "Power Line Communications - Past, Present and Future", IEEE International Symposium on power line communication ISPLC, 1999.
- [2] S. Galli, A. Scaglione, *et al.*, "For the grid and through the grid : the role of power line communications in the smart grid", Proceedings of the IEEE, vol. 99, no. 6, June 2011.
- [3] Seventh Framework Programme: Theme 3 ICT-213311 OMEGA, Deliverable D3.2, "PLC Channel Characterization and Modelling", Dec. 2008.
- [4] D. Schneider, J. Speidel, L. Stadelmeier and D. Schill, "Precoded Spatial Multiplexing MIMO for Inhome Power Line Communications," *IEEE Global Telecommunications Conference*, New Orleans, LO, Nov. 2008.
- [5] R. Hashmat, P. Pagani, A. Zeddami, T. Chonavel, "MIMO communications for inhome PLC networks: Measurements and results up to 100 MHz," *IEEE International Symposium on Power Line Communications*, ISPLC 2010, Rio de Janeiro, Brazil, Mar. 2010
- [6] F. Versolatto, A. Tonello, "A MIMO PLC random channel generator and capacity analysis" IEEE International Symposium on Power Line Communications, ISPLC 2011, Udine, Italy, April 2011
- [7] Home Plug Alliance, "HomePlug AV specifications," Version 1.1, May 2007
- [8] M. Zimmermann, K. Dostert, "Analysis and modeling of impulsive noise in broad-band powerline communications ," *IEEE Trans. on Electromagnetic Comaptibility*, vol. 44, no. 1, pp. 249-258, Feb 2002.
- [9] H. Meng, Y. L. Guan and S. Chen, "Modeling and analysis of noise effects on broadband power\_line communications," *IEEE Trans. on Power Delivery.*, vol. 20, no. 2, pp. 630-637, April 2005.
- [10] F. Corripio, J. Arrabal, L. del Rio, J. Munoz, "Analysis of the Cyclic Short-Term Variations of Indoor Power Line Channels," *IEEE Journal on Selected Areas in Comm.*, vol.24, no.7, pp. 1327-1338, July 2006.
- [11] T. Esmailian, "Multi mega-bit per second data transmission over in-building power lines" *Ph.D Thesis*, University of Toronto, Canada, 2003.
- [12] N. Andreadou, F. Pavlidou, "Modeling the noise on the OFDM power line communication systems," *IEEE Trans. on Power Delivery.*, vol. 25, no. 1, pp. 150-157, Jan 2010.
- [13] R. Hashmat, P. Pagani, A. Zeddami, T. Chonavel, "Measurement and analysis of inhome MIMO PLC channel noise," *Workshop on Power Line Communications, WSPLC 2010*, Boppard, Germany, Sep. 2010.
- [14] A. Neumaier, T. Schneider, "Estimation of parameters and eigenmodes of multivariate autoregressive models", *ACM Trans. On Math. Softwares* vol.27, no.1, pp. 27-57, March 2001.
- [15] S. Kruzevac, P. Rapajic, R. Kennedy, "Channel capacity estimation for MIMO systems with correlated noise," *IEEE International Symposium on Information Theory*, Nice, France, June 2007
- [16] R. Hashmat, P. Pagani, A. Zeddami, T. Chonavel, "A channel model for multiple input multiple output inhome power line networks," *IEEE International Symposium on Power Line Communications*, ISPLC 2011, Udine, Italy, Apr. 2011
- [17] R. Hashmat, P. Pagani, A. Zeddami, T. Chonavel, "Analysis and modeling of background noise for inhome MIMO PLC channels," Submitted to *IEEE International Symposium on Power Line Communications*, ISPLC 2012, Beijing, China, Mar. 2012