



HAL
open science

Virtual braids from a topological viewpoint

Bruno Aaron Cisneros de La Cruz

► **To cite this version:**

Bruno Aaron Cisneros de La Cruz. Virtual braids from a topological viewpoint. 2013. hal-00940106v2

HAL Id: hal-00940106

<https://hal.science/hal-00940106v2>

Preprint submitted on 18 Jun 2015

HAL is a multi-disciplinary open access archive for the deposit and dissemination of scientific research documents, whether they are published or not. The documents may come from teaching and research institutions in France or abroad, or from public or private research centers.

L'archive ouverte pluridisciplinaire **HAL**, est destinée au dépôt et à la diffusion de documents scientifiques de niveau recherche, publiés ou non, émanant des établissements d'enseignement et de recherche français ou étrangers, des laboratoires publics ou privés.

Virtual braids from a topological viewpoint

BRUNO A. CISNEROS DE LA CRUZ

Abstract

Virtual braids are a combinatorial generalization of braids. We present abstract braids as equivalence classes of braid diagrams on a surface, joining two distinguished boundary components. They are identified up to isotopy, compatibility, stability and Reidemeister moves. We show that virtual braids are in a bijective correspondence with abstract braids. Finally we demonstrate that for any abstract braid, its representative of minimal genus is unique up to compatibility and Reidemeister moves. The genus of such a representative is thus an invariant for virtual braids. We also give a complete proof of the fact that there is a bijective correspondence between virtually equivalent virtual braid diagrams and braid-Gauss diagrams.

Contents

1	Introduction	1
2	Virtual braids and Gauss diagrams	3
2.1	Virtual braids.	3
2.2	Braid Gauss diagrams.	5
2.3	Virtual braids as Gauss diagrams	14
2.4	Presentation of PV_n	16
3	Abstract braids	18
4	Minimal realization of an abstract braid	24

1 Introduction

A knot diagram is an oriented planar closed curve in general position (only transversal double points, called crossings) with a function that assigns to each crossing a sign, either positive or negative. Knot diagrams are identified up to Reidemeister moves and the equivalence classes are in bijective correspondence with knots in \mathbf{R}^3 . Some approaches to knot theory are by means of knot diagrams.

There is a combinatorial way to describe an oriented planar closed curve in general position called the Gauss word. It was described by Gauss [4, pp. 85] in his unpublished notebooks. The main idea of this approach is to consider the curve as an oriented graph where the vertices are the crossings of the curve and the edges are the oriented segments joining two crossings.

This idea has been retaken by O. Viro and M. Polyak in order to express knot diagrams in a combinatorial way. To do this, they introduced the notion of Gauss diagrams to compute Vassiliev's invariants [16]. In fact Mikhail N. Goussarov proved that all Vassiliev invariants can be calculated in this way.

The theory of virtual knots was introduced by L. Kauffman [7] as a generalization of classical knot theory. A virtual knot diagram is an oriented planar closed curve in general position with a function that assigns to each crossing a value that can be positive, negative or virtual. Virtual knot diagrams are identified up to Reidemeister, virtual and mixed moves.

Goussarov, Polyak and Viro [6] showed that there is a bijection between virtually equivalent virtual knot diagrams and Gauss diagrams. Moreover they showed that any Vassiliev invariant of classical knots can be extended to virtual knots and calculated via Gauss diagrams formulas.

Braids are a fundamental part of knot theory, as each link can be represented as the closure of a braid [1] (Alexander's theorem) and there is a complete characterization of the closure of braids given by Markov's theorem [14].

L. Kauffman defined virtual braids and virtual string links and he also gave a virtual version of Alexander's theorem [9]. Independendtly S. Kamada also proved a virtual version of Alexander's theorem and a full characterization of the closure of virtual braids, i.e. a virtual version of Markov's theorem [10].

Goussarov, Polyak and Viro defined Gauss diagrams for virtual string links. All though they stated that, up to virtual and mixed moves, each Gauss diagram defines a unique virtual string link diagram [6, 12], it is not clear that this statement is still true for virtual braids.

In Section 2 we describe the braid version of Gauss diagrams and then we prove that each braid-Gauss diagram defines, up to virtual and mixed moves, a unique virtual braid diagram. Then we introduce the Ω moves in braid-Gauss diagrams and we show that there is a bijection a bijection between the Ω equivalence classes of braid-Gauss diagrams and the virtual braids. Finally we recover the presentation given for the pure virtual braids in [2].

This result is quite technical and it has been considered as folklore in literature, even though it was missing a rigorous proof. Gauss diagrams allow us to manage global information with much more liberty as they express the interaction among all strands along the time. On the other hand, on Gauss digrams we can obvious the virtual crossings, as the valuable information of virtual objects underlies on how the strands interacts with themselves through regular crossings, this information is expressed on the arrows of the Gauss diagrams. In particular they become our main tool to prove the results of Section 3 and in [12] are used to define and calculate Milnor invariants of virtual string links.

On the other hand, classical knot theory works with topological objects that can be studied with topological, analytic, algebraic and combinatorial tools. Virtual knots diagrams encodes the combinatorial information of a Gauss diagram, but these are not topological objects. A topological interpretation of these objects was done by N. Kamada, S. Kamada and J. Carter [5, 11]. They defined abstract links as link diagrams on surfaces, identified up to stable equivalence and Reidemeister moves. They proved that abstract links are in bijective correspondence with virtual links.

A representation of a virtual knot in a closed surface is called a *realization* of the virtual knot. The stable equivalence identifies different realizations, which means that a virtual knot may be realized in different surfaces. G. Kuperberg proved that any virtual link admits a realization in a surface of minimal genus and, up to diffeomorphism and Reidemeister moves, this realization is unique [13].

In this paper we provide a topological interpretation of virtual braids inspired by [11, 13]. In Section 3 we introduce the notion of abstract braid diagrams, that are braid diagrams in a surface with two distinguished boundary components and a real smooth function satisfying some conditions. We also introduce the stable equivalence of abstract braid diagrams. The *abstract braids* are the abstract braid diagrams identified up to compatibility, stable equivalence and Reidemeister moves. We prove that abstract braids are in bijective correspondence with virtual

braids.

The notion of abstract braid diagram must not be confused with the definition given in [11], even if the concept is quite similar. An abstract diagram in [11] is a pair (S, D) , with S an oriented, compact surface and D is a diagram in S such that D is a deformation retract of S . In any case, what we define as abstract braid diagram corresponds to the realization of an abstract diagram in [11].

In Section 4 (Theorem 4.9) we prove that given an abstract braid, there is a unique abstract braid diagram (up to Reidemeister moves and compatibility) of minimal genus.

These results states some questions for future work:

1. For any virtual braid diagram there exists a minimal thickened abstract braid representative. Can this representative induce a normal form on virtual braids?
2. We can see virtual braids as virtual string links, but in virtual string links we have more Reidemeister and virtual moves. Thus, given two virtual braids equivalent as virtual string link, are they equivalent as virtual braids? i.e. Does virtual braids embeds in virtual string links?
3. Given a thickened abstract braid diagram $\bar{\beta} = (M_S, f, \beta)$, what is the relation between the fundamental group of $M_S \setminus \beta$ and the group of the virtual link [3, 11] obtained by the closure of $\bar{\beta}$?

2 Virtual braids and Gauss diagrams

We fix the next notation: set n a natural number, the interval $[0, 1]$ is denoted by I , and the 2-cube is denoted by $\mathbf{D} = I \times I$. The projections on the first and second coordinate from the 2-cube to the interval, are denoted by $\pi_1 : \mathbf{D} \rightarrow I$ and $\pi_2 : \mathbf{D} \rightarrow I$, respectively. A set of planar curves is said to be in *general position* if all its multiple points are transversal double points.

2.1 Virtual braids.

Definition 2.1. A *strand diagram* on n strands is an n -tuple of curves, $\beta = (\beta_1, \dots, \beta_n)$, where $\beta_k : I \rightarrow \mathbf{D}$ for $k = 1, \dots, n$, such that:

1. There exists $\sigma \in S_n$ such that, for $k = 1, \dots, n$, we have $\beta_k(0) = a_k$ and $\beta_k(1) = b_{\sigma(k)}$, where $a_k = (0, \frac{k}{n+1})$ and $b_k = (1, \frac{k}{n+1})$.
2. For $k = 1, \dots, n$ and all $t \in I$, $(\pi_1 \circ \beta_k)(t) = t$.
3. The set of curves in β is in general position.

The curves β_k are called *strands* and the transversal double points are called *crossings*. The set of crossings is denoted by $\mathcal{C}(\beta)$.

A *virtual braid diagram* on n strands is a strand diagram on n strands β endowed with a function $\epsilon : \mathcal{C}(\beta) \rightarrow \{+1, -1, v\}$. The crossings are called *positive*, *negative* or *virtual* according to the value of the function ϵ . The positive and negative crossings are called *regular crossings* and the set of regular crossings is denoted by $R(\beta)$. In the image of a regular neighbourhood (homeomorphic to a disc sending the center to the crossing) we replace the image of the involved strands as in Figure 1, according to the crossing type.

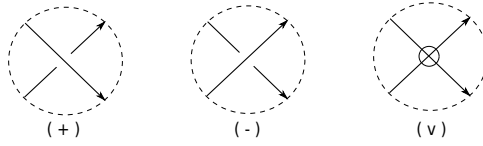

Figure 1: Positive, negative and virtual crossings.

Without loss of generality we draw the braid diagrams from left to right. We denote the set of virtual braid diagrams on n strands by VBD_n .

Definition 2.2. Given two virtual braid diagrams on n strands, β_1 and β_2 , and a neighbourhood $V \subset \mathbf{D}$, homeomorphic to a disc, such that:

- Up to isotopy $\beta_1 \setminus V = \beta_2 \setminus V$.
- Inside V , β_1 differs from β_2 by a diagram as either in Figure 2, or in Figure 3, or in Figure 4.

Then we say that β_2 is obtained from β_1 by an $R2a$, $R2b$, $R3$, $V2$, $V3$, M or M' moves.

The moves $R2a$, $R2b$, $R3$ are called *Reidemeister moves*, the moves $V2$ and $V3$ are called *virtual moves*, and the moves M and M' are called *mixed moves*.

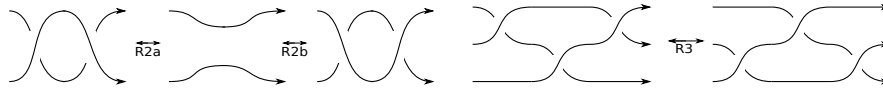

Figure 2: Reidemeister moves.

Let β and β' be two virtual braid diagrams. Note that if β can be obtained from β' by a finite series of virtual, mixed or Reidemeister moves, necessarily β and β' have the same number of strands.

If β' can be obtained from β by isotopy and a finite number of virtual, Reidemeister or mixed moves, β and β' are *virtually Reidemeister equivalent*. We denote this by $\beta \sim \beta'$. These equivalence classes are called *virtual braids on n strands*. We denote by $VB_n = VBD_n / \sim$ the set of virtual braids on n strands.

If β' can be obtained from β by isotopy and a finite number of virtual or mixed moves, β and β' are *virtually equivalent*. We denote this by $\beta \sim_{vm} \beta'$.

If β' can be obtained from β by isotopy and a finite number of Reidemeister moves, β and β' are *Reidemeister equivalent*. We denote this by $\beta \sim_R \beta'$.

Remark 2.3. Define the product of two virtual braids diagrams as the concatenation of the diagrams and an isotopy in the obtained diagram, to fix it in \mathbf{D} . With this operation the set of virtual braid diagrams has the structure of a monoid. It is not hard to see that it factorizes in a group when we consider the virtual Reidemeister equivalence classes. Thus, the set of virtual braids has the structure of a group with the product defined as the concatenation of virtual braids. The virtual braid group on n strands has the following presentation:

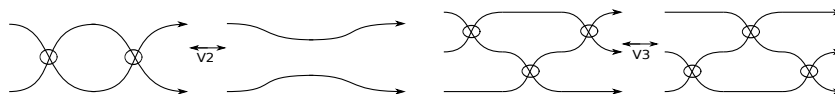

Figure 3: Virtual moves.

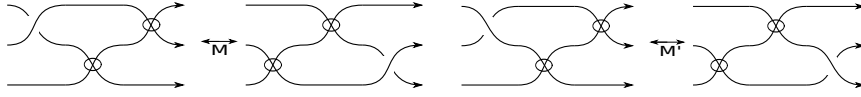

Figure 4: Mixed moves.

- Generators: $\sigma_1, \dots, \sigma_{n-1}, \tau_1, \dots, \tau_{n-1}$.
- Relations:

$$\begin{aligned}
 \sigma_i \sigma_{i+1} \sigma_i &= \sigma_{i+1} \sigma_i \sigma_{i+1} && \text{for } 1 \leq i \leq n-2 \\
 \sigma_i \sigma_j &= \sigma_j \sigma_i && \text{if } |i-j| \geq 2 \\
 \tau_i \tau_{i+1} \tau_i &= \tau_{i+1} \tau_i \tau_{i+1} && \text{for } 1 \leq i \leq n-2 \\
 \tau_i \tau_j &= \tau_j \tau_i && \text{if } |i-j| \geq 2 \\
 \sigma_i \tau_{i+1} \tau_i &= \tau_{i+1} \tau_i \sigma_{i+1} && \text{for } 1 \leq i \leq n-2 \\
 \tau_i \sigma_j &= \sigma_j \tau_i && \text{if } |i-j| \geq 2 \\
 \tau_i^2 &= 1 && \text{for } 1 \leq i \leq n-1
 \end{aligned}$$

Remark 2.4. The mixed moves can be replaced by the moves showed in Figure 5.

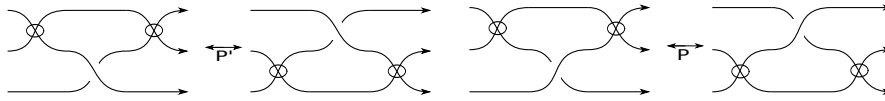

Figure 5: Equivalent mixed moves.

2.2 Braid Gauss diagrams.

Definition 2.5. A *Gauss diagram* on n strands G is an ordered collection of n oriented intervals $\sqcup_{i=1}^n I_i$, together with a finite number of arrows and a permutation $\sigma \in S_n$ such that:

- Each arrow connects by its ends two points in the interior of the intervals (possibly the same interval).
- Each arrow is labelled with a sign ± 1 .
- The end point of the i -th interval is labelled with $\sigma(i)$.

Gauss diagrams are considered up to orientation preserving homeomorphism of the underlying intervals.

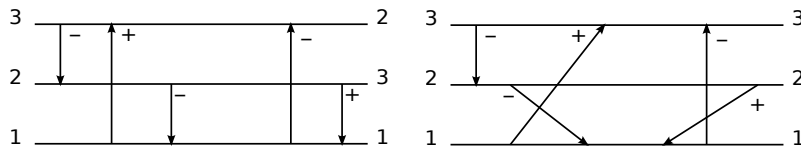

Figure 6: Gauss diagrams

Definition 2.6. Let β be a virtual braid diagram on n strands. The *Gauss diagram* of β , $G(\beta)$, is a Gauss diagram on n strands given by:

- Each strand of $G(\beta)$ is associated to the corresponding strand of β .
- The endpoints of the arrows of $G(\beta)$ correspond to the preimages of the regular crossings of β .
- Arrows are pointing from the over-passing string to the under-passing string.
- The signs of the arrows are given by the signs of the crossings (their local writhe).
- The permutation of $G(\beta)$ correspond to the permutation associated to β .

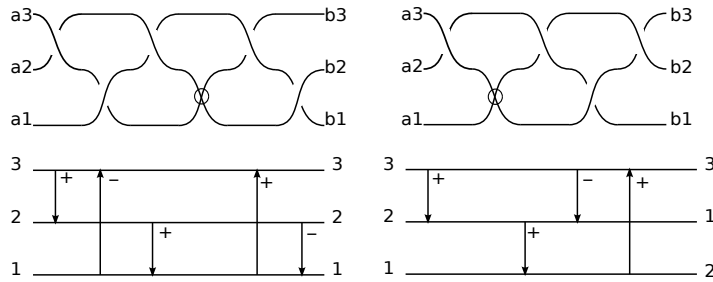

Figure 7: Gauss diagrams of virtual braid diagrams

Remark 2.7. The arrows of the Gauss diagram of any virtual braid diagram are pairwise disjoint and each arrow connects two different intervals. Furthermore we can draw them perpendicular to the underlying intervals, i.e. we can parametrize each interval I_n with respect to the standard interval $I = [0, 1]$, in such a way that the beginning and ending points of each arrow correspond to the same $t \in I$ and such that different arrows correspond to different t 's in I , see Figure 7.

Definition 2.8. Gauss diagrams satisfying the conditions of Remark 2.7 are called *braid Gauss diagrams*. The set of braid Gauss diagrams on n strands is denoted by bGD_n .

Definition 2.9. Given a braid-Gauss diagram, G , we can associate a total order to the set of arrows in G , given by the order in which the arrows appear in the interval I , i.e. let a and b be two arrows in G , such that a appears first, then $a > b$. This order is not defined in the equivalence class of the Gauss diagram, as it may change with orientation preserving homeomorphisms of the underlying intervals.

We denote by $P(G)$ the partial order obtained as the intersection of the total orders associated to G . Given a virtual braid diagram β , let $G(\beta)$ be its Gauss diagram. Then $P(G(\beta))$ defines a partial order in the set of regular crossings, $R(\beta)$. We denote it by $P(\beta)$.

Theorem 2.10. 1. Let g be a braid-Gauss diagram on n strands. Then there exists $\beta \in VBD_n$ such that $G(\beta) = g$.

2. Let β_1 and β_2 be two virtual braids on n strands. Then $G(\beta_1) = G(\beta_2)$ if and only if $\beta_1 \sim_{vm} \beta_2$.

From now on we fix $n \in \mathbf{N}$ the number of strands on the braid-Gauss diagrams, and we say braid-Gauss diagram instead of braid-Gauss diagram on n strands. We split the proof of this theorem into some lemmas.

Lemma 2.11. Let g be a braid-Gauss diagram. Then there exists $\beta \in VBD_n$ such that $G(\beta) = g$.

Proof. Let g be a braid-Gauss diagram and $A = \{c_1, \dots, c_k\}$ be the set of arrows of g . Set a parametrization of the intervals as described in Remark 2.7. This induces an order in A given by $c_i > c_j$ if $p_i < p_j$, where $p_i \in I$ is the corresponding endpoint of c_i . Suppose that $c_i > c_j$ if $i < j$.

Recall the notation of Definition 2.1. For $j = 1, \dots, k$ let $d_j = (\frac{j}{k+1}, \frac{1}{2})$ and consider the disc D_j with radius $r = \frac{1}{5(k+1)}$ centered in d_j . Draw a crossing inside D_j according to the sign of c_j , and label the intersection of the crossing components with the boundary of D_j as in Figure 8.

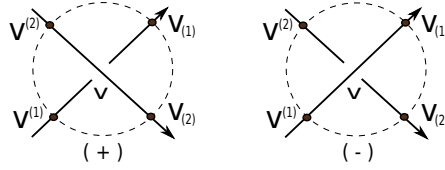

Figure 8: Labelled neighbourhoods of regular crossings.

Drawing the strands: let $\sigma \in S_n$ be the permutation associated to g . Fix $i \in \{1, \dots, n\}$ and let $A_i = \{c_{i_1}, \dots, c_{i_m}\}$ be the arrows starting or ending in the i -th interval.

For $s = 0, \dots, m$ define o_s and t_{s+1} as follows:

1. $o_0 = a_i$ and $t_{m+1} = b_{\sigma(i)}$.
2. For $l = 1, \dots, m$, $o_l = (d_{i_l})^{(v)}$ and $t_l = (d_{i_l})_{(v)}$ where:
 - (a) If c_{i_l} is a positive arrow starting in the i -th interval or a negative arrow ending in the i -th interval then $v = 2$;
 - (b) If c_{i_l} is a negative arrow starting in the i -th interval or a positive arrow ending in the i -th interval then $v = 1$.

For each $s \in \{0, \dots, m\}$, draw a curve joining o_s to t_{s+1} such that it is strictly increasing on the first component and disjoint from the discs D_j for all $j \in \{1, \dots, k\}$ except possibly on the points o_s and t_{s+1} defined above. In this way we have drawn a curve joining a_i with $b_{\sigma(i)}$ passing through the crossings c_{i_1}, \dots, c_{i_m} .

For each $i \in \{1, \dots, k\}$ we can draw a curve as described before, so that they are in general position. Consider the double points outside the discs D_j as virtual crossings. In this way we have constructed a virtual braid diagram such that its Gauss diagram coincides with g . \square

Lemma 2.12. Let β_1 and β_2 be two virtual braid diagrams on n strands such that they are virtually equivalent. Then $G(\beta_1) = G(\beta_2)$.

Proof. In order to see this we only need to verify that the $V2$, $V3$, M and M' moves do not change the braid-Gauss diagram of a virtual braid diagram. In the cases of the $V2$ and $V3$ moves they involve only virtual crossings, which are not represented in the Gauss diagram, so they do not change the Gauss diagram. In the case of the M and M' moves, the Gauss diagrams of the equivalent virtual braid diagrams are equal (Figure 9), thus this type of move neither changes the Gauss diagram of the virtual braid diagram. \square

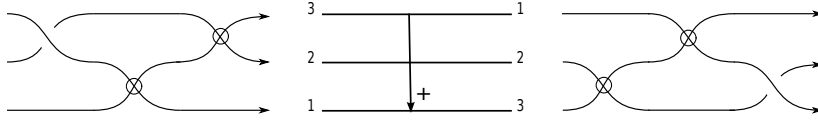

Figure 9: Gauss code of the mixed move.

Definition 2.13. Given $\beta \in VBD_n$ we can deform β by an isotopy, in such a way that for $c_i, c_j \in \mathcal{C}(\beta)$ with $i \neq j$, we have that $\pi_1(c_i) \neq \pi_1(c_j)$, in this case we say that β is in *general position*. If $\beta \in VBD_n$ is in general position, let $\mathcal{D}(\beta)$ be the total order associated to $\mathcal{C}(\beta)$, given by $c_i > c_j$ if $\pi_1(c_i) < \pi_1(c_j)$. Denote by $D(\beta)$ the total order of the set of regular crossings, $R(\beta)$, induced by $\mathcal{D}(\beta)$.

Definition 2.14. A *primitive arc* of β is a segment of a strand of β which does not go through any regular crossing (but it may go through virtual ones).

Let $\beta \in VBD_n$. For $v \in R(\beta)$, set a disc D_v centered in v , with a radius small enough so that its intersection with β consists exactly in two transversal arcs as in Figure 8. We denote by $v^{(1)}$ and by $v^{(2)}$ the bottom and upper left intersections of β with ∂D_v , and by $v_{(2)}$ and by $v_{(1)}$ the bottom and upper right intersections of β with ∂D_v as in Figure 8.

Let d be a point in the diagram β , if $d \in \{b_1, \dots, b_n\}$ or $d \in \{c^{(1)}, c^{(2)}\}$ for some $c \in R(\beta)$ we denote d by d^* . Similarly if $d \in \{a_1, \dots, a_n\}$ or $d \in \{c_{(1)}, c_{(2)}\}$ for some $c \in R(\beta)$ we denote d by d_* . A *joining arc* is a primitive arc α such that there exist a_* and b^* with $\alpha(0) = a_*$ and $\alpha(1) = b^*$.

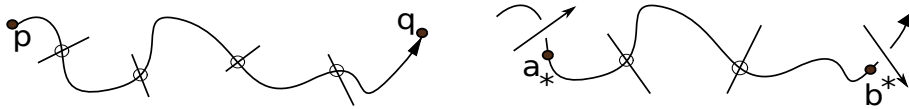

Figure 10: primitive and joining arcs.

As each arc is a segment of a strand $\beta_k : [0, 1] \rightarrow \mathbf{D}$ we can parametrize it with respect to the projection on the first coordinate, i.e. there exists a continuous bijective map $\theta : [t_0, t_f] \rightarrow [0, 1]$ with $0 < t_0 < t_f < 1$ such that $\pi_1(\alpha(\theta(t))) = t$. Without loss of generality we suppose from now on that the arcs are parametrized by the projection on the first coordinate.

Lemma 2.15. Let β be a virtual braid diagram and let α_1, α_2 be two primitive arcs of β such that:

1. The arcs α_1 and α_2 start at the same time, t_0 , and end at the same time, t_f .
2. The arcs α_1 and α_2 start at the same point (a crossing which may be either virtual or regular), i.e. $\alpha_1(t_0) = \alpha_2(t_0)$.
3. The arcs α_1 and α_2 do not intersect, except at the extremes, i.e. $\alpha_1|_{(t_0, t_f)} \cap \alpha_2|_{(t_0, t_f)} = \emptyset$.

Then, there exists a virtual braid diagram β' virtually equivalent to β such that:

1. If β_1 and β_2 are the strands corresponding to α_1 and α_2 respectively, then up to isotopy they remain unchanged in β' , and in their restriction to $(0, t_0) \times I$ we add only virtual crossings.
2. The diagrams β and β' coincide for $t \geq t_f$, i.e. $\beta|_{t \geq t_f} = \beta'|_{t \geq t_f}$.

3. In $(t_0, t_f) \times I$ there are only virtual crossings with α_2 .
4. If $\alpha_1(t_f) = \alpha_2(t_f)$, we can choose β' such that there is no crossing in $(t_0, t_f) \times I$.

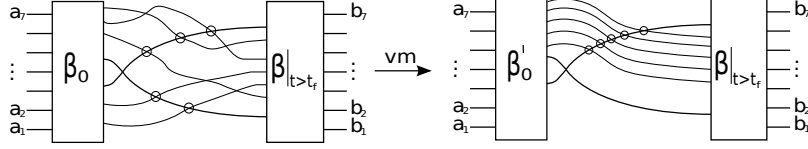

Figure 11: Lemma 2.15.

Proof. Suppose $\alpha_1(t_f) \neq \alpha_2(t_f)$ and that we have reduced β by all the possible $V2$ moves that may be made on it. Note that α_1 , α_2 and $y = t_f$ form a triangle D .

Let C be the set of crossings in β such that their projections on the first component are in the open interval (t_0, t_f) . Let m_0 be the number of crossings in C that are in the interior of D , m_1 the number of crossings in C that are on α_1 , m_2 the number of crossings in C that are on α_2 , and m_∞ the number of crossings in C that are outside D .

We argue by induction on $m = m_0 + m_1 + m_\infty$. Suppose $m = 1$. Then $C = \{c_1, \dots, c_{m_2}, d\}$, where c_1, \dots, c_{m_2} are the crossings on α_2 and d is the other crossing. We have four cases:

1. The crossing d is outside D (Figure 12). We move d by an isotopy to the left part of $I \times [t_0, t_f)$.

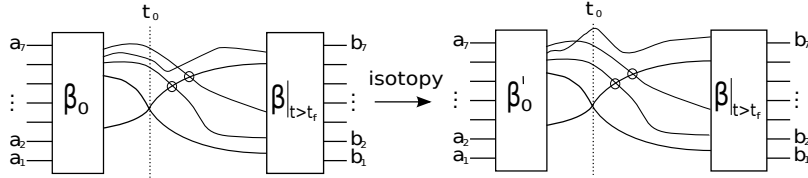

Figure 12: Case 1, Lemma 2.15.

2. The crossing d is inside D (Figure 13). There are two strands entering D that meet at the crossing d . We apply a move of type M , M' or $V3$ according to the value of the crossing d , and then apply Case 1.

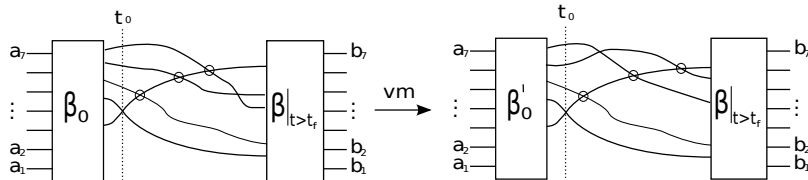

Figure 13: Case 2, Lemma 2.15.

3. The crossing d is on α_1 in such a way that the strand making the crossing with α_1 goes out D (Figure 14). Then such strand also has a crossing with α_2 and is the leftmost crossing on it. Up to isotopy we may apply a move of type M , M' or $V3$ according to the value of the crossing p . Then we are done.

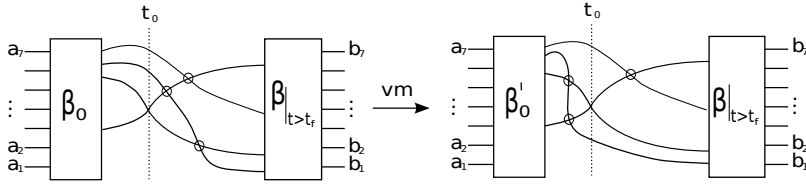

Figure 14: Case 3, Lemma 2.15.

4. The crossing d is on α_1 in such a way that the strand making the crossing with α_1 enters D (Figure 15). Let β_j be that strand. We apply a move of type $V2$ to β_j and β_2 just before the crossing p , then we apply a move of type P , P' or $V3$ according to the value of the crossing p . In this way now d is a crossing on α_2 .

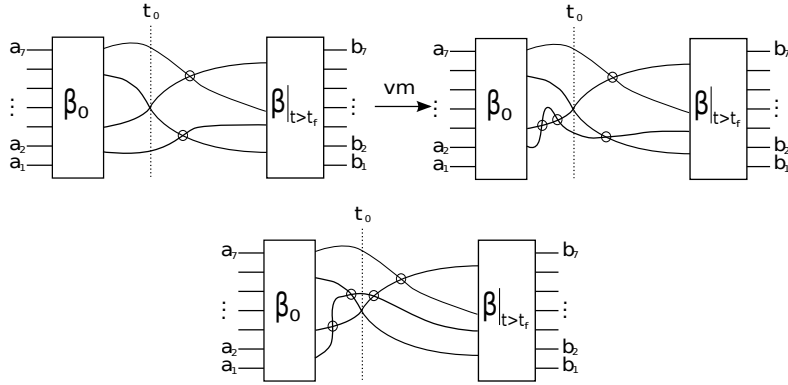

Figure 15: Case 4, Lemma 2.15.

Note that, in the above four cases, we have not deformed β for $t \geq t_f$. Moreover, up to isotopy, β_1 and β_2 remain unchanged and in their restriction to $(0, t_0) \times I$ we have added only virtual crossings.

Now if $m \geq 2$ take d the leftmost crossing in $(t_0, t_f) \times I$ such that d is not on α_2 . We apply the case $m = 1$ in order to get rid of this crossing and reduce the obtained diagram by all the possible $V2$ moves in it. By the induction hypothesis, we have proven (1,2,3) of the lemma.

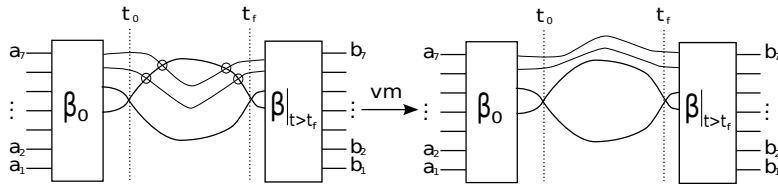

Figure 16: Case $\alpha_1(t_f) = \alpha_2(t_f)$, Lemma 2.15.

Now suppose $\alpha_1(t_f) = \alpha_2(t_f)$. Then α_1 and α_2 form a bigon D . We apply the same reasoning as above in order to have only crossings on α_2 (Figure 16). Suppose that $m_2 \neq 0$, then it necessarily is even (as each strand entering the bigon must go out by α_2). We can apply $\frac{m_2}{2}$ moves of type $V2$ to get rid of the crossings in α_2 . But this is a contradiction as in each inductive step we are reducing the diagram by all the possible $V2$ moves in it. Therefore we can

chose β' such that there are no crossings in $(t_0, t_f) \times I$. With this we complete the proof of the lemma. \square

Corollary 2.16. Let β be a virtual braid diagram and let α_1, α_2 be two primitive arcs of β such that:

1. The arcs α_1 and α_2 start in the same point, say p (thus a crossing, it may be virtual or regular).
2. The arcs α_1 and α_2 end at the same time, say t_f .

Then there exists a virtual braid diagram β' virtually equivalent to β such that:

1. If β_1 and β_2 are the strands corresponding to α_1 and α_2 , respectively, then up to isotopy they remain unchanged in β' and in their restriction to $(0, \pi_1(p) = t_0)$ we add only virtual crossings.
2. The diagrams β and β' coincide for $t \geq t_f$, i.e. $\beta|_{t \geq t_f} = \beta'|_{t \geq t_f}$.
3. Let $\alpha_1 \cap \alpha_2 = \{p = p_1, p_2, \dots, p_m\}$, numbered so that $\pi_1(p_i) < \pi_1(p_{i+1})$ for $1 \leq i \leq m-1$.
 - (a) If $\pi_1(p_m) = t_f$, then in $(t_0, t_f) \times I$ there are no crossings except, eventually, p_2, \dots, p_{m-1} .
 - (b) If $\pi_1(p_m) \neq t_f$, then in $(t_0, \pi_1(p_m)) \times I$ there are no crossings except eventually p_2, \dots, p_{m-1} and in $(\pi_1(p_m), t_f) \times I$ there are only virtual crossings with the corresponding upper segment of α_1 or α_2 .

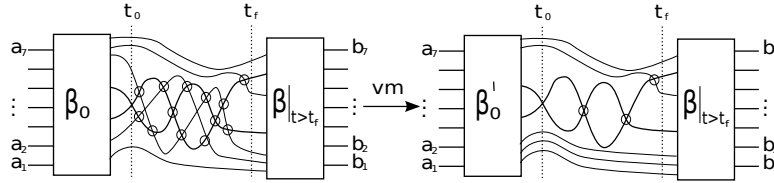

Figure 17: Corollary 2.16.

Proof. Suppose that $\pi_1(p_1) < \dots < \pi_1(p_m)$. We argue by induction on m . Suppose $m = 1$. Then necessarily $p_1 = p$ and we have the hypothesis of Lemma 2.15.

Suppose $m > 1$ and that α_1 and α_2 end in the same point p_m . Consider the restrictions of α_1 and α_2 to $[\pi_1(p_{m-1}), t_f]$ and apply Lemma 2.15. We obtain a virtually equivalent diagram β' which does not have crossings neither on the restriction of α_1 nor on the restriction of α_2 . Furthermore, up to isotopy the strands corresponding to α_1 and α_2 remain unchanged and their restrictions to $[t_0, \pi_1(p_{m-1})]$ go only through virtual crossings, i.e. they are primitive arcs whose intersection has $m-1$ points. Applying induction hypothesis on them, we have proved this case.

Suppose $m > 1$ and that α_1 and α_2 do not end in the same point. Consider the restrictions of α_1 and α_2 to $[\pi_1(p_m), t_f]$ and apply Lemma 2.15. We obtain a virtually equivalent diagram β' which may have only virtual crossings with the corresponding upper segment of α_1 or α_2 . Furthermore, up to isotopy, the strands corresponding to α_1 and α_2 remain unchanged and their restrictions to $[t_0, \pi_1(p_m)]$ go only through virtual crossings, i.e. they are primitive arcs whose intersection has m points and satisfies the condition of the preceding case. With this we conclude the proof. \square

Corollary 2.17. Given a virtual braid diagram β in general position. Let c_1 and c_2 be two regular crossings not related in $P(\beta)$ (Definition 2.9) and such that:

1. In the total order on $R(\beta)$ (Definition 2.13), $D(\beta)$, $c_1 > c_2$.
2. There is no regular crossing between c_1 and c_2 in $D(\beta)$.

Then there exists a virtual braid diagram β' virtually equivalent to β with $c_2 > c_1$ in $D(\beta')$, and such that there is no regular crossing between them.

Furthermore, the diagrams β and β' coincide for $t > t_f$. In particular the total order on the set of elements smaller than c_2 in $D(\beta)$ is preserved in $D(\beta')$, i.e. $c_2 > d_1 > d_2$ in $D(\beta)$, then $c_1 > d_1 > d_2$ in $D(\beta')$.

Proof. Let $t_f > \pi_1(c_2)$ such that there is no crossing in $(\pi_1(c_2), t_f) \times I$ and, let α_1 and α_2 be the primitive arcs coming from the regular crossing c_1 and finishing in t_f . Applying the last corollary to α_1 and α_2 , we obtain a virtually equivalent diagram β' such that in $(\pi_1(c_1), t_f] \times I$ there are only virtual crossings and β remains unchanged for $t \geq t_f$. Thus $c_2 > c_1$ in $D(\beta')$ and if $c_2 > d_1 > d_2$ in $D(\beta)$, then $c_1 > d_1 > d_2$ in $D(\beta')$. \square

Given two orders, R and R' over a set X , we say that R' is compatible with R if $R \subset R'$.

Lemma 2.18. Let β be a virtual braid diagram and let \tilde{R} be a total order on $R(\beta)$ compatible with $P(\beta)$. Then there exists a virtual braid diagram β' virtually equivalent to β such that $D(\beta') = \tilde{R}$.

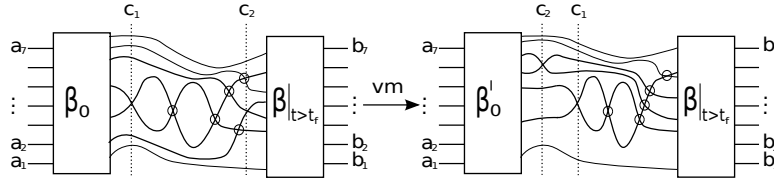

Figure 18: Lemma 2.18.

Proof. Suppose

$$\tilde{R} = \{c_1 > \cdots > c_m\},$$

$$D(\beta) = \{d_1 > \cdots > d_m\},$$

and that $c_l = d_l$ for $l > k$, $c_k \neq d_k$ and $c_k = d_j > d_k$ in $D(\beta)$. Note that for $k \geq l > j$, d_j is not related with d_l in $P(\beta)$. Applying the last corollary $k - j$ times we construct a virtual braid diagram β' virtually equivalent to β such that if $D(\beta') = \{d'_1 > \cdots > d'_m\}$ then $c_l = d'_l$ for $l \geq k$. Applying this procedure inductively we obtain the lemma. \square

Lemma 2.19. Let β_1 and β_2 be two virtual braid diagrams on n strands, and let α_1 and α_2 be two primitive arcs of β_1 and β_2 respectively, such that:

1. The extremes of α_1 and α_2 coincide.
2. α_1 and α_2 form a bigon D .
3. $\beta_1 \setminus \alpha_1$ and $\beta_2 \setminus \alpha_2$ coincide.

4. There are no crossings in the interior of D .

Then β_1 and β_2 are virtually equivalent by isotopy and moves of type V2.

Proof. First note that each strand entering D must go out. Take a strand α entering D and suppose it is innermost. If it goes out by the same side, as there are no crossings in the interior of D , then we can apply a move of type V2 and eliminate the two virtual crossings. Therefore we can suppose that each strands entering by one side goes out by the other. Apply an isotopy following the strands crossing the bigon (if there are any) in order to identify the two primitive arcs. \square

Lemma 2.20. Let β_1 and β_2 be two virtual braid diagrams on n strands, and let α_1 and α_2 be two primitive arcs of β_1 and β_2 respectively, such that:

1. The extremes of α_1 and α_2 coincide.
2. α_1 and α_2 form a bigon D .
3. $\beta_1 \setminus \alpha_1$ and $\beta_2 \setminus \alpha_2$ coincide.

Then β_1 and β_2 are virtually equivalent.

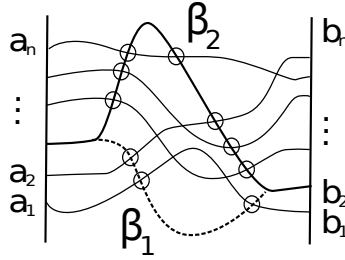

Figure 19: Lemma 2.20.

Proof. Call p and q the starting and ending points of α_1 , and set $\beta = \beta_1 \setminus \alpha_1$. Let m be the number of crossings inside D . We argue by induction on m . If $m = 0$ we apply the last lemma.

Suppose $m \geq 1$ and let c be the leftmost crossing inside D . Choose t_0 and t_1 so that $\pi_1(p) < t_0 < t_1 < \pi_1(c)$ and so that there are no crossings in $D \cap ((t_0, \pi_1(c)) \times I)$. Draw a line a' joining $\alpha_1(t_0)$ and $\alpha_2(t_1)$. Note that a' intersects the two incoming strands that compose c . To the crossings of β with a' assign virtual crossings. Consider the following primitive arcs:

$$\begin{aligned} c_1 &= \alpha_1|_{[\pi_1(p), t_0]} * a' & c_3 &= a' * \alpha_2|_{[t_1, \pi_1(q)]} \\ c_2 &= \alpha_2|_{[\pi_1(p), t_1]} & c_4 &= \alpha_1|_{[t_0, \pi_1(q)]}. \end{aligned}$$

Note that c_1 and c_2 form a bigon that has no crossing in its interior, so we apply the last lemma to $\beta'_2 = (\beta_2 \cup c_1) \setminus c_2$ and β_2 .

On the other hand, take the bigon D' formed by c_3 and c_4 . D' has the same crossings as D , and c is still the leftmost crossing in D' . By construction of β'_2 we can apply a move of type V3, M or M' to move a' to the other side of c . Call the obtained virtual braid diagram β'_1 . Then

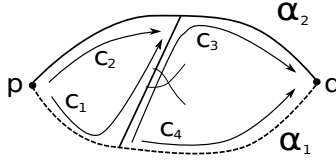

Figure 20: Construction in proof of Lemma 2.20.

the bigon formed between β'_1 and β_1 has $m - 1$ crossings in its interior. Applying the induction hypothesis to β_1 and β'_1 we conclude that

$$\beta_1 \sim_{vm} \beta'_1 \sim_{vm} \beta'_2 \sim_{vm} \beta_2,$$

which proves the lemma. \square

Corollary 2.21. Let β_1 and β_2 be two virtual braid diagrams on n strands, and let α_1 and α_2 be two primitive arcs of β_1 and β_2 , respectively, such that:

1. The extremes of α_1 and α_2 coincide.
2. $\beta_1 \setminus \alpha_1$ and $\beta_2 \setminus \alpha_2$ coincide.

Then β_1 and β_2 are virtually equivalent.

Proof. Without loss of generality we can suppose that α_1 intersects transversally α_2 in a finite number of points. In this case they form a finite number of bigons. Apply the previous lemma to each one. \square

Now we are able to complete the proof of Theorem 2.10. We have already proved (1) in Lemma 2.11. In Lemma 2.12 we have shown that if $\beta \sim_{vm} \beta'$ then $G(\beta) = G(\beta')$. It remains to prove that if $\beta, \beta' \in VBD_n$ are so that $G(\beta) = G(\beta')$, then $\beta \sim_{vm} \beta'$. Set $g = G(\beta) = G(\beta')$.

Let \tilde{R} be a total order of $R(G)$, compatible with $P(G)$. By Lemma 2.18 there exist two virtual braid diagrams, α and α' , virtually equivalent to β and β' respectively and such that $D(\alpha) = \tilde{R} = D(\alpha')$. As $D(\alpha) = D(\alpha')$ we can suppose that the regular crossings of α and α' coincide (if not, move them by an isotopy to make them coincide). In this case α and α' differ by joining arcs.

Suppose α has m joining arcs. As the regular crossings of α and α' coincide, we can suppose that the corresponding joining arcs of α and α' begin and end at the same points. Apply Corollary 2.21 m times, in order to make that each of the corresponding joining arcs coincide. We conclude that α is virtually equivalent to α' and thus β and β' .

2.3 Virtual braids as Gauss diagrams

The aim of this section is to establish a bijective correspondence between virtual braids and certain equivalence classes of braid-Gauss diagrams. We also give the group structure on the set of virtual braids in terms of Gauss diagrams, and use this to prove a presentation of the pure virtual braid group.

Definition 2.22. Let g and g' be two Gauss diagrams. A *Gauss embedding* is an embedding $\varphi : g' \rightarrow g$ which send each interval of g' into a subinterval of g , and which sends each arrow of g' to an arrow of g respecting the orientation and the sign. Note that there is no condition on the permutations associated to g' and g in the above definition. We shall say that g' is embedded in g if a Gauss embedding of g' into g is given.

Let g' be a Gauss diagram of n strands, so that it is embedded in g by sending the interval i to a subinterval of the interval k_i of g , we say that the embedding is of type (k_1, \dots, k_n) .

Consider the three Gauss diagrams presented in Figure 21. Note that g_1 is embedded in g_2 by an embedding of type $(2, 1)$, and g_3 is embedded in g_2 by an embedding of type $(1, 2, 3)$.

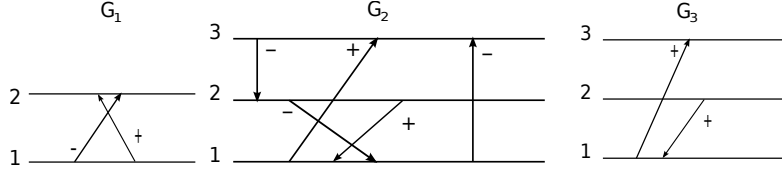

Figure 21: G_1 is $(1, 2)$ -embedded in G_2 , and G_3 is $(1, 2, 3)$ -embedded in G_2 .

By performing an $\Omega 3$ move on a braid Gauss diagram g , we mean choosing an embedding in g of the braid Gauss diagram depicted on the left hand side of Figure 22 (or on the right hand side of Figure 22), and replacing it by the braid Gauss diagram depicted on the right hand side of Figure 22 (resp. on the left hand side of Figure 22).

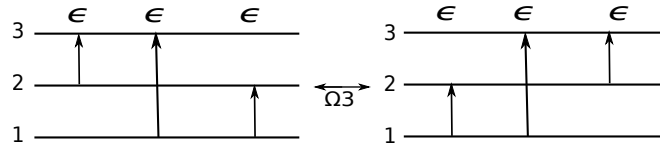

Figure 22: $\Omega 3$ move on Gauss diagrams, with $\epsilon \in \{\pm 1\}$.

Let g be a Gauss diagram with n strands and $i, j, k \in \{1, \dots, n\}$ with $i < j < k$. The six different types of embeddings of the Gauss diagram in Figure 22 in g are illustrated in Figures 23, 24 and 25. According to the type of embedding the $\Omega 3$ move is called $\Omega 3$ move of type (k_1, k_2, k_3) .

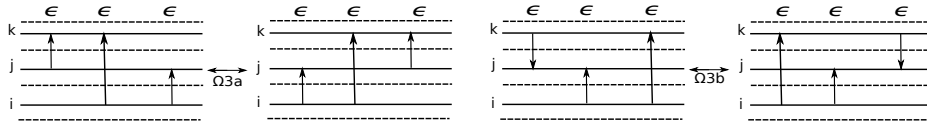

Figure 23: $\Omega 3$ moves of type (i, j, k) and (i, k, j) .

Similarly, by performing an $\Omega 2$ move on a braid Gauss diagram g , we mean choosing an embedding in g of the braid Gauss diagram depicted on the left hand side of Figure 26 (or on the right hand side of Figure 26), and replacing it by the braid Gauss diagram depicted on the right hand side of Figure 26 (resp. on the left hand side of Figure 26).

In this case there are only two types of embeddings. They are illustrated in Figure 27.

Definition 2.23. The equivalence relation generated by the $\Omega 2$ and the $\Omega 3$ moves in the set of braid Gauss diagrams is called *Reidemeister equivalence*. The set of equivalence classes of braid Gauss diagrams is denoted by bG_n .

Proposition 2.24. There is a bijective correspondence between bG_n and VB_n .

Proof. By Theorem 2.10 we know that there is a bijective correspondence between the set of virtually equivalent virtual braid diagrams and the braid Gauss diagrams. Therefore we need to prove that if two virtual braid diagrams are related by a Reidemeister move then their braid

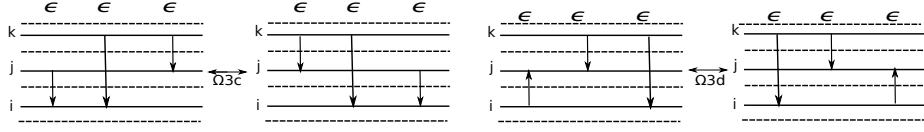

Figure 24: $\Omega 3$ moves of type (j, i, k) and (j, k, i) .

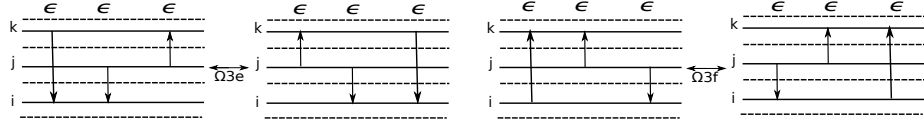

Figure 25: $\Omega 3$ moves of type (k, i, j) and (k, j, i) .

Gauss diagrams are Reidemeister equivalent, and that if two braid Gauss diagrams are related by an $\Omega 2$ or an $\Omega 3$ move then their virtual braid diagrams are virtually Reidemeister equivalent.

Let β and β' be two virtual braid diagrams that differ by a Reidemeister move. Suppose that they are related by a $R3$ move, and that the strands involved in the move are a , b , and c , with $a, b, c \in \{1, \dots, n\}$. Then, up to isotopy we can deform the diagrams so that they coincide outside the subinterval $I_0 := [t_0, t_f] \subset I$, and in I_0 there are only the crossings involved in the $R3$ move. In I_0 the diagrams look as in Figure 28. Thus, their braid-Gauss diagrams coincide outside I_0 and in I_0 they differ by an $\Omega 3$ move of type (a, b, c) . The case $R2$ is proved in the same way.

Now, let g and g' be two braid Gauss diagrams and let $a, b, c \in \{1, \dots, n\}$ be pairwise different. Suppose that g and g' are related by an $\Omega 3$ move of type (a, b, c) . There exists a subinterval $I_0 = [t_0, t_f] \subset I$, that contains only the three arrows involved in the $\Omega 3$ move. There exists a virtual braid diagram β , representing g , that in the subinterval I_0 it looks as the left hand side (or the right hand side) of Figure 28. By performing an $R3$ move on $\beta|_{I_0}$, we obtain a virtual braid diagram β' . Their braid Gauss diagrams coincides outside I_0 and in I_0 the differ by an $\Omega 3$ move of type (a, b, c) , i.e. $G(\beta') = g'$. □

2.4 Presentation of PV_n .

Recall that VB_n has a group structure, with the product given by the concatenation of the diagrams (Remark 2.3). By Proposition 2.24, bG_n has a group structure induced by the one on VB_n .

A presentation of the *pure virtual braids* was given by Bardakov [2]. We present an alternative proof by means of the braid Gauss diagrams.

Recall that the symmetric group, S_n , has the next presentation:

- Generators: t_1, \dots, t_{n-1} .
- Relations:

$$\begin{aligned} t_i t_{i+1} t_i &= t_{i+1} t_i t_{i+1} && \text{for } 1 \leq i \leq n-2 \\ t_i t_j &= t_j t_i && \text{for } |i-j| \geq 2. \\ t_i^2 &= 1 && \text{for } 1 \leq i \leq n-1. \end{aligned}$$

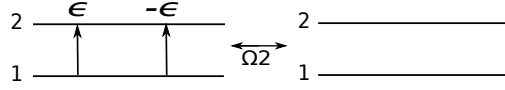

Figure 26: $\Omega 2$ move on Gauss diagrams.

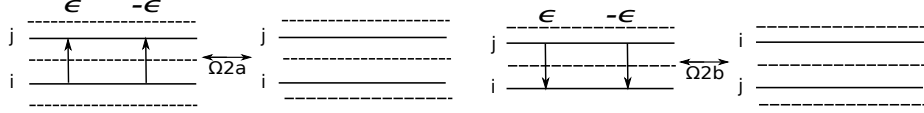

Figure 27: $\Omega 2$ moves of type (i, j) and (j, i) .

From the presentation of VB_n (Remark 2.3), there exists an epimorphism $\theta_P : VB_n \rightarrow S_n$, given by

$$\theta_P(\tau_i) = t_i = \theta_P(\sigma_i) \quad \text{for } 1 \leq i \leq n - 1.$$

The kernel of θ_P is called the *pure virtual braid group* and is denoted by PV_n . The elements of this group correspond to the virtual braids diagrams whose strands begin and end in the same marked point, i.e. the permutation associated to its braid Gauss diagram is the identity.

On the other hand, a braid Gauss diagram is composed by the next elements:

1. A finite ordered set of n intervals, say $I_1 \sqcup I_2 \sqcup \dots \sqcup I_n$.
2. A finite set of arrows connecting the different intervals, so that to each arrow corresponds a different time.
3. A function assigning a sign, $\{\pm 1\}$, to each arrow.
4. A permutation, $\sigma \in S_n$, labelling the endpoint of each interval.

Denote by $X_{i,j}^\epsilon$ the arrow from the interval i to the interval j with sign $\epsilon \in \{\pm 1\}$. Let

$$X = \{X_{i,j}^\epsilon \mid 1 \leq i \neq j \leq n, \epsilon \in \{\pm 1\}\}$$

and denote by X^* the set of all words in X union the empty word, denoted by e .

Given a braid Gauss diagram, g , its arrows have a natural order induced by the parametrization of the intervals. Let $W \in X^*$ be the word given by the concatenation of the arrows in g , according to the order in which they appear, and $\sigma \in S_n$ its associated permutation. Thus any braid Gauss diagram can be expressed as $g = (W, \sigma)$. We denote $\bar{e} := (e, Id_{S_n})$.

Proposition 2.25. (Bardakov [2]) The group PV_n has the following presentation:

- Generators: $A_{i,j}$ with $1 \leq i \neq j \leq n$.
- Relations:

$$\begin{aligned} A_{i,j}A_{i,k}A_{j,k} &= A_{j,k}A_{i,k}A_{i,j} \quad \text{for } i, j, k \text{ distinct.} \\ A_{i,j}A_{k,l} &= A_{k,l}A_{i,j} \quad \text{for } i, j, k, l \text{ distinct.} \end{aligned}$$

Proof. Given a pure virtual braid diagram β , its braid Gauss diagram is given by $G(\beta) = (W, Id_{S_n})$. Thus any pure virtual braid diagram may be expressed as an element in X^* .

Recall that, as elements of bG_n , the braid Gauss diagrams are related by three different moves (and its inverses) on the subwords of any word in X^* :

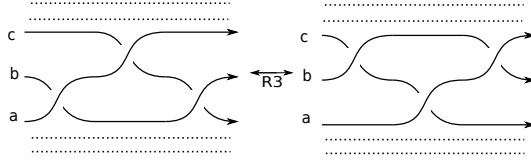

Figure 28: A labelled $R3$ move.

1. Reparametrization:

$$X_{i,j}^{\epsilon_1} X_{k,l}^{\epsilon_2} = X_{k,l}^{\epsilon_2} X_{i,j}^{\epsilon_1} \text{ for } i, j, k, l \text{ distinct and } \epsilon_1, \epsilon_2 \in \{\pm 1\}.$$

2. The $\Omega 2$ move:

$$X_{i,j}^{\epsilon} X_{i,j}^{-\epsilon} = e \text{ for } i, j \text{ distinct and } \epsilon \in \{\pm 1\}.$$

3. The $\Omega 3$ move:

$$X_{i,j}^{\epsilon} X_{i,k}^{\epsilon} X_{j,k}^{\epsilon} = X_{j,k}^{\epsilon} X_{i,k}^{\epsilon} X_{i,j}^{\epsilon} \text{ for } i, j, k \text{ distinct and } \epsilon \in \{\pm 1\}.$$

Denote by PG_n the set of equivalence classes of X^* . Note that PG_n has the structure of group with the product defined as the concatenation of the words. On the other hand $G : PV_n \rightarrow PG_n$ is an homomorphism, i.e. $G(\beta_1\beta_2) = G(\beta_1)G(\beta_2)$. By Proposition 2.24, G is a bijection. Consequently it is an isomorphism.

Let Γ be the group with presentation as stated in the proposition. Let $\Psi : \Gamma \rightarrow PG_n$ be given by

$$\Psi(A_{i,j}) = X_{i,j},$$

and let $\Phi : PG_n \rightarrow \Gamma$ be given by

$$\Phi(X_{i,j}^{\epsilon}) = A_{i,j}^{\epsilon}.$$

Note that Φ and Ψ are well-defined homomorphisms and furthermore $\Psi \circ \Phi = Id_{PG_n}$ and $\Phi \circ \Psi = Id_{\Gamma}$. Consequently PV_n has the presentation stated in the proposition. \square

3 Abstract braids

The aim of this section is to establish a topological representation of virtual braids.

Definition 3.1. A *abstract braid diagram on n strands* is a quadruple $\bar{\beta} = (S, f, \beta, \epsilon)$, such that:

1. S is a connected, compact and oriented surface.
2. The boundary of S has only two connected components, i.e. $\partial S = C_0 \sqcup C_1$, with $C_0 \approx S^1 \approx C_1$. They are called *distinguished boundary components*.
3. Each boundary component of S has n marked points, say $K_0 = \{a_1, \dots, a_n\} \subset C_0$ and $K_1 = \{b_1, \dots, b_n\} \subset C_1$. Such that:
 - (a) The elements of K_0 and K_1 are linearly ordered.
 - (b) Let $\kappa_0 : S^1 \rightarrow C_0$ and $\kappa_1 : S^1 \rightarrow C_1$ be parametrizations of C_0 and C_1 compatible with the orientation of S . Up to isotopy we can put $a_k = \kappa_0(e^{\frac{2\pi i}{k}})$ and $b_k = \kappa_1(e^{-\frac{2\pi i}{k}})$ for $k \in \{1, \dots, n\}$.

4. f is a smooth function, $f : S \rightarrow I$ such that $f^{-1}(\{0\}) = C_0$ and $f^{-1}(\{1\}) = C_1$.

5. β is an n -tuple of curves $\beta = (\beta_1, \dots, \beta_n)$ with

(a) For $k = 1, \dots, n$, $\beta_k : I \rightarrow S$.

(b) For $k = 1, \dots, n$, $\beta_k(0) = a_k$.

(c) There exists $\sigma \in S_n$ such that

$$\beta_k(1) = b_{\sigma(k)},$$

for all $k \in \{1, \dots, n\}$.

(d) For $k = 1, \dots, n$ and $t \in I$, $f \circ \beta_k(t) = t$.

(e) The n -tuple of curves β is in general position, i.e. there are only transversal double points, called crossings.

6. Similarly to Definition 2.1, denote by $R(\beta)$ the set of crossings of β . Then ϵ is a function,

$$\epsilon : R(\beta) \rightarrow \{\pm 1\}.$$

From now on we fix $n \in \mathbf{N}$ and we say abstract braid diagram instead of abstract braid diagram on n strands.

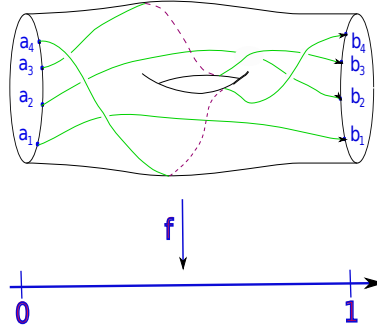

Figure 29: An abstract braid diagram on four strands.

Definition 3.2. An *isotopy* of abstract braid diagrams is a family of abstract braid diagrams $G = \{\bar{\beta}^s = (S, f^s, \beta^s, \epsilon^s)\}_{s \in I}$, such that:

1. For all $s \in I$, $K_0^s = K_0^0$ and $K_1^s = K_1^0$.

2. For all $k \in \{1, \dots, n\}$, H_k is continuous, where:

$$\begin{aligned} H_k : I \times I &\rightarrow S \\ (s, t) &\mapsto \beta_k^s(t). \end{aligned}$$

3. The function H is smooth, where:

$$\begin{aligned} H : I \times S &\rightarrow I \\ (s, x) &\mapsto f^s(x). \end{aligned}$$

4. The function $\epsilon^s : R(\beta^s) \rightarrow \{\pm 1\}$ remains invariant, i.e. $\epsilon^s = \epsilon^0$, for all $s \in I$.

We say that $\bar{\beta}^0$ and $\bar{\beta}^1$ are isotopic and we denote it by $G : \bar{\beta}^0 \simeq \bar{\beta}^1$.

Remark 3.3. The isotopy relation is an equivalence relation on the set of abstract braid diagrams.

Definition 3.4. Let $\bar{\beta} = (S, f, \bar{\beta}, \epsilon)$ and $\bar{\beta}' = (S', f', \bar{\beta}', \epsilon')$ be two abstract braid diagrams. We say that $\bar{\beta}$ and $\bar{\beta}'$ are *compatible* if there exists a diffeomorphism $\varphi : (S, \partial S) \rightarrow (S', \partial S')$, such that $\varphi_*\bar{\beta} = (S', f' \circ \varphi^{-1}, \varphi \circ \bar{\beta}, \epsilon)$ is isotopy equivalent to $\bar{\beta}'$. We denote it by $\bar{\beta} \approx \bar{\beta}'$.

Remark 3.5. The compatibility relation is an equivalence relation on the set of abstract braid diagrams, and the isotopy equivalence is included in the compatibility relation. We denote by ABD_n the set of compatibility classes of abstract braid diagrams on n strands.

Definition 3.6. Given $\bar{\beta}^0 = (S_0, f_0, \beta^0, \epsilon_0)$ and $\bar{\beta}^1 = (S_1, f_1, \beta^1, \epsilon_1)$. We say that they are related by a *stability move* if there exist:

1. Two disjoint embedded discs, D_0 and D_1 , in $S_0 \setminus \beta^0$.
2. An embedding $\varphi : (S'_0 = S_0 \setminus (D_0 \cup D_1), \partial S_0) \rightarrow (S_1, \partial S_1)$, such that $S_1 \setminus \varphi(S'_0) \approx S^1 \times I$.
3. A smooth function $F : S_1 \rightarrow I$, such that:
 - (a) $f_0|_{S'_0} = F \circ \varphi$.
 - (b) The quadruple $(S_1, F, \varphi \circ \beta^0, \epsilon_0)$ is an abstract braid.
 - (c) $(S_1, F, \varphi \circ \beta^0, \epsilon_0) \approx \bar{\beta}^1$.

Definition 3.7. Given $\bar{\beta}^0 = (S_0, f_0, \beta^0, \epsilon_0)$ and $\bar{\beta}^1 = (S_1, f_1, \beta^1, \epsilon_1)$. We say that they are related by a *destability move* or a *destabilization*, if there exist:

1. An essential non-separating simple curve C in $S_0 \setminus \beta^0$.
2. An embedding $\varphi : (S'_0 = S_0 \setminus C, \partial S_0) \rightarrow (S_1, \partial S_1)$, such that $S_1 \setminus \varphi(S_0 \setminus C)$ is homeomorphic to the disjoint union of two closed discs.
3. A smooth function $F : S_1 \rightarrow I$, such that:
 - (a) $f_0|_{S'_0} = F \circ \varphi$.
 - (b) The quadruple $(S_1, F, \varphi \circ \beta^0, \epsilon_0)$ is an abstract braid.
 - (c) $(S_1, F, \varphi \circ \beta^0, \epsilon_0) \approx \bar{\beta}^1$.

Given two abstract braid diagrams $\bar{\beta}^0$ and $\bar{\beta}^1$, if $\bar{\beta}^1$ is obtained from $\bar{\beta}^0$ from a stability move along two discs D_0 and D_1 in $S_0 \setminus \beta^0$, the boundaries of D_0 and D_1 are homotopy equivalent in S_1 . If we perform a destabilization along its homotopy class we recover $\bar{\beta}^0$, up to compatibility.

Reciprocally if $\bar{\beta}^1$ is obtained from $\bar{\beta}^0$ by a destabilization along an essential curve C , then we can recover $\bar{\beta}^0$, up to compatibility, with a stabilization along the two capped discs in $S_0 \setminus C$, see Figure 30.

Definition 3.8. The equivalence relation on the set of abstract braids generated by the stability (and destability) moves is called *stability equivalence*. We denote it by \sim_s .

Definition 3.9. Let $\bar{\beta} = (S, f, \beta, \epsilon)$ be an abstract braid, and let C be an embedded simple closed curve in $S \setminus \beta$. Denote by S_C the connected component of $S \setminus C$ containing β . Let S'_C be a compact, connected, oriented surface and $\varphi : S_C \rightarrow S'_C$ such that:

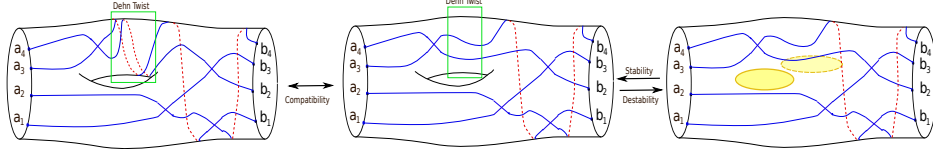

Figure 30: Compatibility and stability equivalence.

1. The surface S'_C has only two boundary components C'_0 and C'_1 .
2. The map φ is an embedding such that $\varphi(C_0) = C'_0$ and $\varphi(C_1) = C'_1$.
3. Let k_C be the number of connected components of $S \setminus C$.
 - (a) If $k_C = 1$, then $S'_C \setminus \varphi(S_C)$ is homeomorphic to a disjoint union of two discs.
 - (b) If $k_C = 2$, then $S'_C \setminus \varphi(S_C)$ is homeomorphic to a disc.

Let $F_C : S'_C \rightarrow I$ be a smooth function such that $F|_{\varphi(S_C)} = f|_{S_C}$ (note that up to isotopy, this extension is unique). Then $\bar{\beta}_C = (S'_C, F_C, \varphi \circ \beta, \epsilon)$ is an abstract braid. We say that we obtain $\bar{\beta}_C$ by *destabilizing* $\bar{\beta}$ along C , and is called a *generalized destabilization*.

Proposition 3.10. Let $\bar{\beta} = (S, f, \beta, \epsilon)$ be an abstract braid, and let C be an embedded simple closed curve in $S \setminus \beta$. Then $\bar{\beta}_C$ is stable equivalent to $\bar{\beta}$ by a finite number of destabilizations.

Proof. First note that if $S \setminus C$ has only one connected component the generalized destabilization along C coincides with the definition of destabilization. Thus $\bar{\beta} \sim_s \bar{\beta}_C$ by one destabilization.

So, we can assume that $S \setminus C$ has two connected components, one of which contains β (we call it S_C) and the other is a compact connected surface with one boundary component, thus it is homeomorphic to $\Sigma_{g,1}$. We will prove the proposition by induction on g .

If $g = 0$ then $\Sigma_{0,1}$ is a disc, thus $F_C \simeq f|_{S_C}$ and consequently $\bar{\beta}_C \approx \bar{\beta}$.

If $g = 1$ then $\Sigma_{1,1}$ is a torus with one boundary component, which corresponds to the curve C . Let C' be a closed simple essential non separating curve in $\Sigma_{1,1}$. We claim that $\bar{\beta}_C \approx \bar{\beta}_{C'}$.

Note that $\Sigma_{1,1} \setminus C'$ is homeomorphic to a pair of pants (Figure 31), whose exterior boundary is the curve C and whose interior boundaries correspond to the boundaries generated by cutting S along C' .

On the other hand consider the curve C' embedded in S . The surface $S \setminus C'$ has one connected component and two (non distinguished) boundary components. Let S' be the surface obtained from $S \setminus C'$ by capping the boundary components corresponding to C' . There exist a disc, D' , embedded in S' so that its boundary corresponds to the curve C . Thus S_C is embedded in $S_{C'}$ and $S_{C'}$ is embedded in S' .

Suppose $\iota : S_C \hookrightarrow S_{C'}$ and $\varphi_{C'} : S_{C'} \hookrightarrow S'$ are the embeddings. Denote $\varphi_C = \varphi_{C'} \circ \iota$. Let $F_C : S' \rightarrow I$ be an extension of $f|_{S_C}$ and $F_{C'} : S' \rightarrow I$ be an extension of $f|_{S_{C'}}$. Note that F_C and $F_{C'}$ differ only in the interior of the disc bounded by C . Consequently $F_C \simeq F_{C'}$. From this we conclude that $\bar{\beta}_C \approx \bar{\beta}_{C'}$. Thus $\bar{\beta} \sim_s \bar{\beta}_C$ by a unique destabilization.

Suppose that the proposition is true when the second connected component is homeomorphic to $\Sigma_{k,1}$.

Choose a simple essential closed curve C which divides S in two connected components, from which the component that does not contain β is homeomorphic to $\Sigma_{k+1,1}$. Take a simple essential closed curve C' in $\Sigma_{k+1,1}$, which is not isotopic to C in $\Sigma_{k+1,1}$. Destabilize $\bar{\beta}$ along C' . Then, by induction, $\bar{\beta}$ is stable equivalent to $\bar{\beta}_{C'}$. The curve C is still a simple closed curve in $S_{C'} \setminus \beta$, thus we can destabilize $\bar{\beta}_{C'}$ along C .

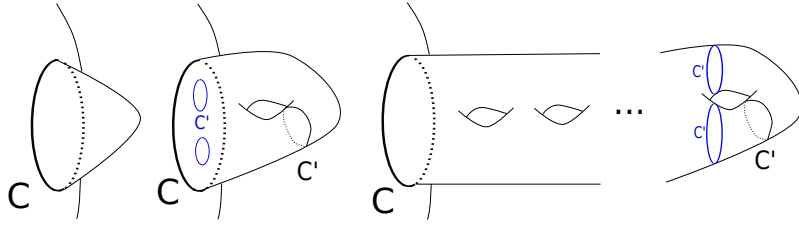

Figure 31: Generalized destabilization along a curve C .

By induction hypothesis, the destabilization of $\bar{\beta}_{C'}$ along C is stable equivalent to $\bar{\beta}_{C'}$. Thus $\bar{\beta}$ is stable equivalent to $(\bar{\beta}_{C'})_C$.

Without loss of generality we can suppose that $(\varphi_{C'})_C = \varphi_C$, and note that F_C and $(F_{C'})_C$ differ by an isotopy in the disc bounded by C . Consequently $(\bar{\beta}_{C'})_C \approx \bar{\beta}_C$ and $\bar{\beta} \sim_s \bar{\beta}_C$. \square

Definition 3.11. Given two abstract braid diagrams $\bar{\beta} = (S, f, \beta, \epsilon)$ and $\bar{\beta}' = (S, f', \beta', \epsilon')$, we say that they are related by a *Reidemeister move* or simply by an *R-move* if, up to isotopy, $f = f'$ and there exists a neighbourhood D in S , homeomorphic to a disc, such that $\beta \setminus D = \beta' \setminus D$, $\epsilon|_{\beta \setminus D} = \epsilon'|_{\beta' \setminus D}$, and inside D we can transform β into β' by a Reidemeister move and isotopy (Figure 2). The equivalence relation generated by the *R-moves* is called *Reidemeister equivalence* or simply *R-equivalence*. We denote it by $\bar{\beta} \sim_R \bar{\beta}'$.

Definition 3.12. Let \sim be the equivalence relation on the abstract braid diagrams on n strands generated by the compatibility, stability and Reidemeister moves. The equivalence classes of abstract braid diagrams are called abstract braids, and the set of abstract braids is denoted by AB_n .

Remark 3.13. The definition of braid Gauss diagram is extended in a natural way to the set of abstract braid diagrams. The braid Gauss diagram of an abstract braid diagram is invariant under compatibility (resp. under isotopy) and stability.

Thus, there is a well defined map from ABD_n to bGD_n , which associates to each abstract braid diagram its braid Gauss diagram. This map is well defined up to compatibility and stability. By abuse of notation we denote the induced map still by G .

Recall that the set of braid Gauss diagrams is in bijective correspondence with the set of virtually equivalent virtual braid diagrams. Thus, braid Gauss diagrams are a good tool to prove that abstract braids are a good geometric interpretation of virtual braids. We present an analogous of Theorem 2.10 for abstract braid diagrams.

Claim 3.14. The map $G : ABD_n \rightarrow bGD_n$ induces a bijection between the stable equivalence classes of abstract braid diagrams and the braid Gauss diagrams.

Proof. Recall that the function is well defined from the stable and compatibility equivalence classes of Abstract braid diagrams to the braid Gauss diagrams (Remark 3.13).

Now we proof the surjectivity. Let $g \in bGD_n$. Then by Theorem 2.10 there exists a virtual braid diagram β such that $G(\beta) = g$. For each $\beta \in VBD_n$ we can construct an abstract braid diagram $\bar{\beta}$ such that $G(\bar{\beta}) = G(\beta)$ as follows.

Let β be a virtual braid diagram, and let N be a regular neighbourhood of $\beta \cup (\{0\} \times I) \cup (\{1\} \times I)$ in $\mathbf{D} = I \times I$ (Figure 32). Note that N can be seen as the union of regular neighbourhoods of each strand and of the two extremes of the virtual braid diagram.

Now consider the standard embedding of \mathbf{D} in \mathbf{R}^3 . Around each virtual crossing perturb the regular neighbourhoods of the strands involved in the crossing so that they do not intersect, as pictured in Figure 32. To the regular neighbourhood of each extreme attach a ribbon so that each extreme is now a cylinder, as in Figure 32. In this way we obtain a compact oriented surface, S' , with more than the two distinguished boundary components. Consider the function $f : S' \rightarrow [0, 1]$ defined by the projection on the first coordinate in \mathbf{R}^3 .

As S' is compact, connected and oriented, it is diffeomorphic to $\Sigma_{g,b}$. We can cap all the non-distinguished boundary components in order to obtain a surface S that has only the distinguished boundary components. There exists an embedding $\varphi : S' \rightarrow S$ and a smooth function $F : S \rightarrow I$, such that $f = F \circ \varphi$. In this way we have constructed an abstract braid diagram $\bar{\beta} = (S, F, \beta, \epsilon)$ such that $G(\bar{\beta}) = G(\beta)$. From this we conclude that the function G is surjective.

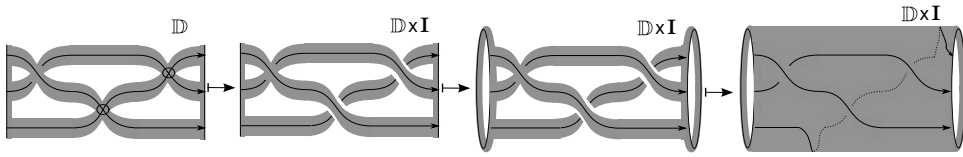

Figure 32: Construction of $\bar{\beta}$ from β such that $G(\bar{\beta}) = G(\beta)$.

Now to prove injectivity of the induced function, let $\bar{\beta} = (S, f, \beta, \epsilon)$ and $\bar{\beta}' = (S', f', \beta', \epsilon')$ be two abstract braid diagrams such that $G(\bar{\beta}) = G(\bar{\beta}')$. We claim that $\bar{\beta}$ is stable equivalent to $\bar{\beta}'$.

Note that $G(\bar{\beta}) = G(\bar{\beta}')$ implies that the graph given by $\Gamma = C_0 \cup \beta \cup C_1 \subset S$ is homeomorphic to $\Gamma' = C'_0 \cup \beta' \cup C'_1 \subset S'$. Consider a regular neighbourhood of Γ in S , N , and a regular neighbourhood of Γ' in S' , N' . Thus there exists an homeomorphism $\varphi : N \rightarrow N'$, with $\varphi(\Gamma) = \Gamma'$.

As N is homeomorphic to $\Sigma_{g,k+2}$, it has k non-distinguished boundary components. We can cap the k non-distinguished boundary components of N to obtain a surface Σ that has only the two distinguished boundary components. There exists an embedding $\iota : N \rightarrow \Sigma$ and a smooth function $F : \Sigma \rightarrow I$ such that $f|_N = F \circ \iota$. In this way we have constructed an abstract braid diagram $\bar{\alpha} = (\Sigma, F, \iota \circ \beta, \epsilon)$ stable equivalent to $\bar{\beta}$.

On the other hand, note that $f|_N$ is homotopic to $g = f' \circ \varphi$ and as $\Sigma \setminus N$ is a disjoint union of circles, then we can extend g to Σ so that it is homotopy equivalent to F . Thus without loss of generality we can suppose that $f|_N = f' \circ \varphi$. This implies that, up to compatibility and destabilizations along the non-distinguished boundary components of N and N' , we can obtain $\bar{\alpha}$ from $\bar{\beta}$ and from $\bar{\beta}'$. Thus $\bar{\beta}$ and $\bar{\beta}'$ are stable equivalent, consequently the induced function on the stable equivalence classes is injective. □

Theorem 3.15. There exists a bijection between the abstract braids on n strands and the virtual braids on n strands.

Proof. We need to verify that the function induced by G , from AB_n to bG_n , is well defined and that it remains injective. By abuse of notation we denote the induced map still by G .

Let $\bar{\beta} = (S, f, \beta, \epsilon)$ and $\bar{\beta}' = (S, f, \beta', \epsilon')$ be two abstract braid diagrams related by an R -move. We need to see that $G(\bar{\beta})$ is related to $G(\bar{\beta}')$ by an $\Omega 2$ or an $\Omega 3$ move. By definition of an R -move, there exists a neighbourhood, D , diffeomorphic to a disc, such that β and β' coincide outside D . Up to isotopy we can suppose that in the interval $f(D) = f'(D)$ there are no other crossings that the involved on the R -move. In this way to perform an R -move in D is equivalent

to perform an $\Omega 2$ or an $\Omega 3$ move in the braid Gauss diagram. Consequently G is well defined from AB_n to bG_n .

To prove the injectivity, let $\bar{\beta}$ and $\bar{\beta}'$ be two abstract braids diagrams such that $G(\bar{\beta})$ and $G(\bar{\beta}')$ are related by an $\Omega 2$ move. Note that the strands involved in the $\Omega 2$ move of β (resp. of β') in the regular neighbourhood constructed in the proof of Claim 3.14 look either as in the left hand side or as in the right hand side of Figure 33 (resp. right hand side or left hand side). Deform the regular neighbourhood of the right hand side by gluing a disc in the middle, so that it looks as in the center of Figure 33. Then we can embed both diagrams in the same surface and relate them by a $R2$ move. Then $\bar{\beta}$ and $\bar{\beta}'$ are related by a stability and a Reidemeister move. The case when $G(\beta)$ and $G(\beta')$ are related by an $\Omega 3$ move is proved similarly and illustrated in Figure 34. Thus G is injective and the theorem is true. \square

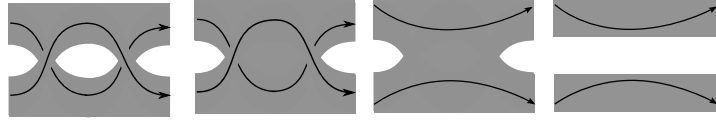

Figure 33: Strands involved in the $\Omega 2$ move.

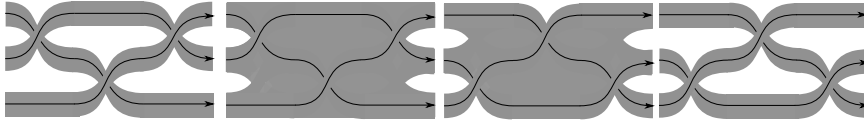

Figure 34: Strands involved in the $\Omega 3$ move.

As a consequence of the proof of the last theorem we have the next corollary.

Corollary 3.16. Given an abstract braid diagram $\bar{\beta}$. Let $[\bar{\beta}]_s$ be its stable equivalence class. There exists a unique, up to compatibility, $\bar{\alpha} \in [\bar{\beta}]_s$, such that for all $\bar{\beta}' \in [\bar{\beta}]_s$, $\bar{\alpha}$ is obtained from $\bar{\beta}'$ by a finite number of destabilizations.

4 Minimal realization of an abstract braid

Given an abstract braid diagram $\bar{\beta} = (S, f, \beta, \epsilon)$ we call the genus of $\bar{\beta}$ to the genus of S . We denote it by $g(\bar{\beta})$.

Recall that ABD_n denotes the set of equivalence classes of abstract braid diagrams, identified up to isotopy and compatibility equivalence. Note that the genus of an abstract braid diagram is preserved by the isotopy and compatibility equivalence. Thus we can define the genus of an element of ABD_n . From now on we will confuse an abstract braid diagram with its compatibility and isotopy equivalence class.

On the other hand AB_n denotes the set of stability and Reidemeister equivalence classes of abstract braid diagrams. The Reidemeister equivalence preserves the genus of an abstract braid. Denote by TAB_n the set of isotopy, compatibility and Reidemeister equivalence classes of abstract braid diagrams.

Denote by $[\bar{\beta}]$ the stability and Reidemeister equivalence class of the abstract braid diagram $\bar{\beta}$. Given $[\bar{\beta}] \in AB_n$ the stability equivalence defines an order on $[\bar{\beta}]$ given by $\bar{\beta} < \bar{\beta}'$ if $\bar{\beta}$ is obtained from $\bar{\beta}'$ through Reidemeister and destabilization moves. Note that a destabilization always reduces the genus of an abstract braid diagram and the genus is a non negative number.

The aim of this section is to prove that two minimal elements in $[\bar{\beta}] \in AB_n$ are related by a finite number of isotopies, compatibilities, and Reidemeister moves, that is, they represent the same element in TAB_n .

Recall that there is a bijective correspondence between AB_n and VB_n (Theorem 3.15). In particular, for a virtual braid β there exists a distinguished topological representative of β , given by its minimal representative $\bar{\beta} \in TAB_n$.

Another straightforward consequence is that we can define the genus of a virtual braid as the genus of the minimal topological representative of β , and this is an invariant of the virtual braid, i.e. its value does not change up to isotopy and virtual, Reidemeister and mixed moves.

A regular braid is a virtual braid that has only regular crossings. A corollary of the previous discussion is that if a virtual braid can be reduced to a regular braid, then necessarily its genus must be zero. Eventhough, there are some virtual braids whose genus is zero and that are not regular, for example consider the virtual braid $\beta = \sigma_1\tau_1$, we have that $g(\beta) = 0$, but it is not a regular braid (Figure 35).

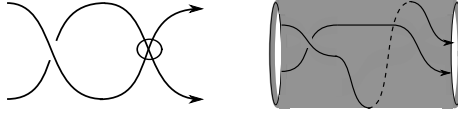

Figure 35: No regular braid with genus 0.

Regular braid diagrams are projections of geometric braids in $\mathbf{D} \times I$ on \mathbf{D} . It is well known that regular braids coincide with isotopy classes of geometric braids identified up to isotopy. In order to have a similar result for abstract braids, we need to define a geometric object in a three dimensional space, such that when it is projected on a two dimensional space we recover the Abstract braid diagrams.

Definition 4.1. A *braid in a thickened surface on n strands* is a triple, $\bar{\beta} = (M_S, F, \beta)$, such that:

1. There exists a compact, connected and oriented surface S , such that $M_S = S \times I$.
2. The boundary of S has only two connected components, i.e. $\partial S = C_0 \sqcup C_1$, with $C_0 \approx S^1 \approx C_1$, called *distinguished boundary components*.
3. Each boundary component of S has n marked points, say $K_0 = \{a_1, \dots, a_n\} \subset C_0$ and $K_1 = \{b_1, \dots, b_n\} \subset C_1$. Such that:
 - (a) The elements of K_0 and K_1 are linearly ordered.
 - (b) Let $\kappa_0 : S^1 \rightarrow C_0$ and $\kappa_1 : S^1 \rightarrow C_1$ be parametrizations of C_0 and C_1 compatible with the orientation of S . Up to isotopy we can put $a_k = \kappa_0(e^{\frac{2\pi i}{k}})$ and $b_k = \kappa_1(e^{-\frac{2\pi i}{k}})$ for $k \in \{1, \dots, n\}$.
4. F is a smooth function, $F : M_S \rightarrow I$ such that, for $i = 0, 1$

$$F^{-1}(\{i\}) = C_i \times I.$$

5. β is an n -tuple of curves $\beta = (\beta_1, \dots, \beta_n)$ with:
 - (a) For $k = 1, \dots, n$, $\beta_k : I \rightarrow M_S$.
 - (b) For $k = 1, \dots, n$, $\beta_k(0) = (a_k, \frac{1}{2})$.

(c) There exists $\sigma \in S_n$ such that for $k = 1, \dots, n$,

$$\beta_k(1) = (b_{\sigma(k)}, \frac{1}{2}).$$

(d) For $k = 1, \dots, n$ and $t \in I$, $F \circ \beta_k(t) = t$.

(e) For $i \neq j$, $\beta_i \cap \beta_j = \emptyset$.

From now on we fix $n \in \mathbf{N}$ and we say braids in a thickened surface instead of braids in a thickened surface on n strands.

Definition 4.2. An *isotopy* of braids in a thickened surface is a family of braids in a thickened surface $G = \{\bar{\beta}^s = (M_S, F^s, \beta^s)\}_{s \in I}$, such that:

1. For all $s \in I$, $K_0^s = K_0^0$ and $K_1^s = K_1^0$.
2. For $k = 1, \dots, n$, H_k is continuous, where:

$$\begin{aligned} H_k : I \times I &\rightarrow M_S \\ (s, t) &\mapsto \beta_k^s(t). \end{aligned}$$

3. The function H is smooth, where:

$$\begin{aligned} H : I \times M_S &\rightarrow I \\ (s, x) &\mapsto F^s(x). \end{aligned}$$

We say that $\bar{\beta}^0$ and $\bar{\beta}^1$ are isotopic and we denote it by $G : \bar{\beta}^0 \simeq \bar{\beta}^1$.

Definition 4.3. Given two thickened braid diagrams $\bar{\beta} = (M_S, F, \beta)$ and $\bar{\beta}' = (M_{S'}, F', \beta')$, we say that they are *compatible* if there exists a diffeomorphism $\varphi : M_S \rightarrow M_{S'}$ such that $F = F' \circ \varphi$ and $\beta' = \varphi \circ \beta$. We denote it by $\bar{\beta} \approx \bar{\beta}'$. Note that the compatibility relation is an equivalence relation.

Fix a thickened surface M_S . Given an isotopy between two braids in M_S , we can decompose the isotopy in a sequence of isotopies so that, in each step, only one strand moves and a bigon is formed by the initial and terminal positions of that strand. Since the bigon is contained in a disc, the projection of this move on the surface looks like Figure 36.

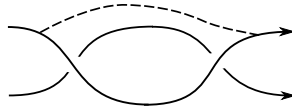

Figure 36: Δ -move.

Such moves are called Δ -moves and generate the Δ -equivalence of abstract braid diagrams on S . Thus, there is a bijective correspondence between the Δ -classes of abstract braid diagrams in S and the isotopy classes of braids in M_S .

On the other side, the Δ -equivalence generates the Reidemeister moves $R2a$, $R2b$ and $R3$ and viceversa, a Δ -move can be expressed as a finite sequence of Reidemeister moves [15, pp. 19-24]. Consequently we have the next lemma.

Lemma 4.4. There is a bijective correspondence between isotopy and compatibility classes of braids in thickened surfaces and TAB_n . We call the elements of TAB_n , *thickened abstract braids* (on n strands).

From now on we will think the elements of TAB_n as isotopy classes of thickened abstract braids.

Definition 4.5. Let $\bar{\beta} = (M_S, F, \beta) \in TAB_n$. Given $A, B \subset M_S$ we say that A is isotopic to B relative to ∂M_S if there exists a continuous function $H : A \times I \rightarrow M_S$ such that:

1. $H_0 = id_A$ and $H_1(A) = B$.
2. For all $s \in I$, H_s is an embedding.
3. For all $s \in I$, $H_s(A \cap \partial M_S) \subset \partial M_S$.

In particular A is diffeomorphic to B , and H induces an isotopy of $A \cap \partial M_S$ and $B \cap \partial M_S$ in ∂M_S .

Definition 4.6. Given $\bar{\beta} = (M_S, F, \beta) \in TAB_n$.

1. A *vertical annulus* in $\bar{\beta}$ is an annulus $A \subset M_S \setminus \beta$, such that $A = C \times I \subset S \times I$ with C a simple closed curve in S .
2. A *destabilization* of $\bar{\beta}$ is an annulus $A \subset M_S \setminus \beta$ isotopic to a vertical annulus $C \times I$ relative to ∂M_S , with C essential and non-separating in S .
3. A *destabilization move* on $\bar{\beta}$ along a destabilization A , is to cut M_S along A , cap the two boundary components with two thickened discs and extend the function to the obtained manifold. We also say to *destabilize* $\bar{\beta}$ along A and we denote the obtained thickened abstract braid by $\bar{\beta}_A$.
4. The equivalence relation generated by these moves in the set of thickened abstract braids is called *stable equivalence*.

As a consequence of Lemma 4.4, the definition of destabilization of a braid in a thickened surface is equivalent to the destabilization of an abstract braid diagram identified up to Reidemeister, isotopy and compatibility equivalence. Consequently we obtain the next proposition.

Proposition 4.7. The abstract braids are in bijective correspondence with the braids in thickened surfaces identified up to stable equivalence.

Recall that the stability equivalence induces an order in TAB_n . This order is generated by destabilizations, i.e. given $\bar{\beta}$ and $\bar{\beta}'$, if there exists a destabilization, A , of $\bar{\beta}'$, such that $\bar{\beta} \approx \bar{\beta}'_A$, then $\bar{\beta} < \bar{\beta}'$.

Definition 4.8. Given $\bar{\beta} \in TAB_n$, a *descendent* of $\bar{\beta}$ is a thickened abstract braid $\bar{\beta}'$ such that $\bar{\beta}' < \bar{\beta}$. An *irreducible descendent* of $\bar{\beta}$ is a descendent of $\bar{\beta}$ that does not admit any destabilization.

Given $\bar{\beta} \in TAB_n$. Let $A \subset M_S \setminus \beta$ be an annulus isotopic to a vertical annulus $A' = C \times I$ relative to ∂M_S . If C is not essential, we say that A is *not essential*. Suppose $A = C \times I$ is vertical and not essential, hence C bounds a disc in S . Let D_0 be the disc bounded by $C \times \{0\}$ in $S \times \{0\}$, and D_1 be the disc bounded by $C \times \{1\}$ in $S \times \{1\}$. Then $A \cup D_0 \cup D_1$ is homeomorphic to a sphere that bounds a ball in $M_S \setminus \beta$. To express this we say that A bounds a ball, and we refer to such ball as the ball bounded by A .

Theorem 4.9. Given $[\bar{\beta}] \in AB_n$ there exists a unique irreducible descendent of $\bar{\beta}$ in TAB_n .

Proof. Let $[\bar{\beta}] \in AB_n$. Suppose that $[\bar{\beta}]$ has two irreducible descendants. In this case $[\bar{\beta}]$ has a representative $\bar{\beta} = (M_S, F, \beta)$, such that S is of minimal genus among the representatives of $[\bar{\beta}]$ admitting two different irreducible descendants.

Since each destabilization reduces the genus, by minimality of the genus of S each destabilization of $\bar{\beta}$ has a unique irreducible descendent. Two destabilizations of $\bar{\beta}$ are called *descendent equivalent* if they have the same irreducible descendent.

We claim that all destabilizations in $\bar{\beta}$ are descendent equivalent. Suppose there exist two destabilizations A_1 and A_2 of $\bar{\beta}$ descendent inequivalent.

Claim 4.10. The intersection of A_1 and A_2 is nonempty.

Proof. Suppose A_1 and A_2 are disjoint. We can destabilize $\bar{\beta}$ along A_1 and then along A_2 and vice-versa. In both cases we obtain a common descendent, i.e. $(\bar{\beta}_{A_1})_{A_2} \approx (\bar{\beta}_{A_2})_{A_1}$. This is a contradiction. \square

Therefore, we can suppose A_1 and A_2 intersect transversally and so that the number of curves in the intersection ($m_{1,2} \geq 1$) is minimal. Furthermore, we can choose A_1 and A_2 so that $m_{1,2}$ is minimal among inequivalent pairs of destabilizations of $\bar{\beta}$.

The intersection between two transversal surfaces is a disjoint union of 1-manifolds. A curve in $A_1 \cap A_2$ is thus either a circle or an arc. A *horizontal circle* in an annulus A is a circle that does not bound a disc in A (Figure 37). A *vertical arc* in an annulus A is a simple arc in A such that its extremes connect the two boundary components of A (Figure 37).

Given a horizontal circle C in an annulus A , it divides A in two annuli A' and A'' (Figure 37) such that:

$$\partial A' = (\partial A \cap (S \times \{0\}) \cup C \quad \text{and} \quad \partial A'' = (\partial A \cap (S \times \{1\}) \cup C.$$

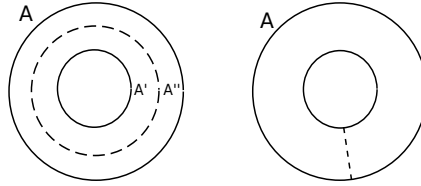

Figure 37: Horizontal circle and vertical arc in A .

Claim 4.11. All the 1-manifolds in $A_1 \cap A_2$ are either horizontal circles or vertical arcs in A_1 and in A_2 .

Proof. Suppose there exists $C \subset A_1 \cap A_2$ such that C is a non-horizontal circle in A_1 . Thus, the circle C bounds a disc D in A_1 , in particular it is null-homotopic in $M_S \setminus \beta$. On the other hand if C is horizontal in A_2 it is homotopic to an essential circle in S and so it is not null-homotopic in M_S . Therefore C is non-horizontal in A_2 .

Suppose that C is innermost (i.e. $\text{int}(D) \cap A_2 = \emptyset$). Consider a regular neighbourhood of D in $M_S \setminus \beta$, $N(D)$. The boundary of $N(D)$, $\partial N(D)$, intersects A_2 in two disjoint circles C' and C'' . The circle C' (resp. C'') bounds a disc D' (resp. D'') in $\partial N(D)$ (Figure 38). The surface $A_2 \setminus N(D)$ has two connected components that we can complete with D' and D'' in order to obtain two surfaces say A'_2 and A''_2 . They can be spheres, annuli or discs in M_S .

Since C is non-horizontal in A_2 and C is innermost in A_1 , necessarily, up to exchanging A'_2 with A''_2 , A'_2 is a sphere and A''_2 is an annulus isotopic to A_2 (Figure 38). By construction $A_1 \cap A''_2$ has less connected components than $A_1 \cap A_2$. This is a contradiction. We conclude that all the circles in $A_1 \cap A_2$ are horizontal in A_i for $i = 1, 2$.

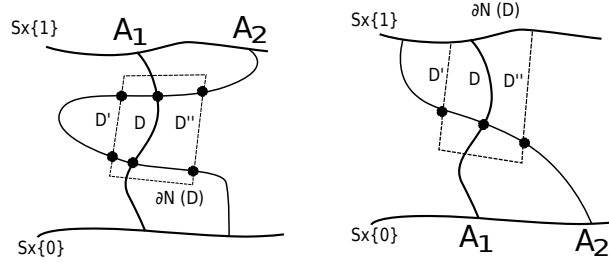

Figure 38: A non-horizontal circle and a non-vertical arc in A_1 .

Let $C \subset A_1 \cap A_2$ be a non-vertical arc in A_1 . Hence, the extremes of C are in the same component of ∂A_1 . Let α be the segment of the component of ∂A_1 that joins the extremes of C so that $C \cup \alpha$ is a simple closed curve that bounds a disc D in A_1 . In particular C is null-homotopic in M_S relative to ∂M_S , consequently, C is also a non vertical arc in A_2 .

Suppose that C is innermost, in the sense that $A_2 \cap \text{int}(D) = \emptyset$. Let $N(D)$ be a regular neighbourhood of D in $M_S \setminus \beta$. The boundary of $N(D)$, $\partial N(D)$, intersects A_2 in two disjoint non-vertical arcs, C' and C'' . With a similar construction as for C , we can find arcs α' and α'' in $\partial N(D) \cap \partial M_S$ such that $C' \cup \alpha'$ (resp. $C'' \cup \alpha''$) bounds a disc D' (resp. D'') in $\partial N(D)$. The surface $A_2 \setminus N(D)$ has two connected components that we can complete with D' and D'' in order to obtain two surfaces A'_2 and A''_2 .

Since C is non-vertical in A_2 and C is innermost in A_1 , necessarily, up to exchanging A'_2 with A''_2 , A'_2 is a disc and A''_2 is an annulus isotopic to A_2 (Figure 38). By construction $A_1 \cap A''_2$ has less connected components than $A_1 \cap A_2$ which is a contradiction. We conclude that all the arcs in $A_1 \cap A_2$ are vertical in A_i for $i = 1, 2$. \square

Claim 4.12. The intersection $A_1 \cap A_2$ does not contain any horizontal circle.

Proof. Let $C \subset A_1 \cap A_2$ be a horizontal circle in A_1 . We have seen that necessarily it is a horizontal circle in A_2 . Then C splits A_1 and A_2 in four annuli, A'_1 , A''_1 , A'_2 and A''_2 . We can choose C so that it is exterior in A_1 in the sense that $\text{int}(A''_1) \cap A_2 = \emptyset$. In this case the annulus A'_1 is isotopic to A''_2 in $M_S \setminus \beta$ relative to ∂M_S . Let A_3 be the annulus $A'_1 \cup A'_2$ deformed by an isotopy in such a way that it is in general position with respect to A_1 (Figure 39).

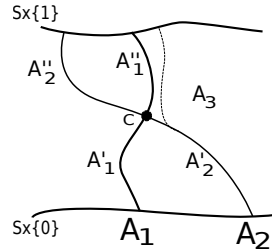

Figure 39: The intersection of two destabilizations along a horizontal circle.

The number of curves in $A_3 \cap A_1$ is strictly less than the number of curves in $A_2 \cap A_1$. Furthermore A_2 is isotopy equivalent to $A''_1 \cup A'_2$ which is isotopy equivalent to A_3 by construction.

Hence A_3 is a destabilization equivalent to A_2 , and $A_3 \cap A_1$ has strictly less curves than $A_2 \cap A_1$. This is a contradiction. \square

Claim 4.13. The intersection $A_1 \cap A_2$ does not contain any vertical arc.

Proof. Let N be a regular neighbourhood of $A_1 \cup A_2$ in $M_S \setminus \beta$. Then ∂N is a disjoint union of m surfaces in M_S . Since there are only vertical arcs in $A_1 \cap A_2$ these surfaces are isotopic to vertical annuli, say $\partial N = B_1 \sqcup B_2 \sqcup \dots \sqcup B_m$. Therefore, either there is a destabilization in ∂N or all the vertical annuli are non-essential.

Suppose that for some $k \in \{1, \dots, m\}$, B_k is a destabilization, i.e. isotopic to an essential vertical annulus. Since B_k is disjoint from A_1 and A_2 , it is descendent equivalent to both. This is a contradiction.

Suppose that for all $k = 1, \dots, m$, B_k is isotopic to a non-essential vertical annulus. Let E_k be the ball bounded by B_k and $S_k = \partial E_k$.

We claim that there exists $k \in \{1, \dots, m\}$ such that $A_1 \cup A_2 \subset E_k$. This is equivalent to say that there exists $k \in \{1, \dots, m\}$ such that $(A_1 \cup A_2) \cap E_k \neq \emptyset$. It is clear that if $A_1 \cup A_2 \subset E_k$ then the intersection is nonempty. On the other hand, suppose there exists $k \in \{1, \dots, m\}$, such that $(A_1 \cup A_2) \cap E_k \neq \emptyset$. Since $B_k \cap (A_1 \cup A_2) = \emptyset$ and by connectivity of $A_1 \cup A_2$ and of E_k , we have $A_1 \cup A_2 \subset E_k$.

Now, suppose there exist $j, k \in \{1, \dots, m\}$, such that $j \neq k$ and $S_k \cap S_j \neq \emptyset$. Then, up to exchanging E_k with E_j , $E_j \subset E_k$. Note that B_j (resp. B_k) separates M_S in two connected components. Furthermore, B_k and $A_1 \cup A_2$ (resp. B_j and $A_1 \cup A_2$) are in the same connected component of $M_S \setminus B_j$ (resp. $M_S \setminus B_k$). Thus $A_1 \cup A_2$ is in the shell bounded by S_j and S_k . In particular $A_1 \cup A_2 \subset E_k$.

If $S_i \cap S_j = \emptyset$, then $E_i \cap E_j = \emptyset$. Suppose that $E_i \cap E_j \neq \emptyset$. As $B_i \cap B_j = \emptyset$, up to exchanging E_i with E_j , $E_i \subset E_j$ and $(S_i \cap \partial M_S) \subset (S_j \cap \partial M_S)$. This is a contradiction.

Suppose that for all $k = 1, \dots, m$, $(A_1 \cup A_2) \cap E_k = \emptyset$ and that $S_i \cap S_j = \emptyset$ for $i \neq j$. As $E_i \cap E_j = \emptyset$ for $i \neq j$, the connected components of $M_S \setminus (\cup_{k=1}^m B_k)$ are $\text{int}(E_1), \dots, \text{int}(E_m)$, and $M_S \setminus (\cup_{k=1}^m E_k)$. But $(A_1 \cup A_2) \cap E_k = \emptyset$ for $k = 1, \dots, m$. Thus β and $A_1 \cup A_2$ are in the same connected component. This is a contradiction, because ∂N separates β and $A_1 \cup A_2$. We conclude that there exists $k \in \{1, \dots, m\}$ such that $A_1 \cup A_2 \subset E_k$.

For $j = 1, 2$ and $i = 0, 1$, set $\gamma_j^i = (S \times \{i\}) \cap A_j$. Since $A_1 \cup A_2 \subset E_k$, we have $\gamma_j^i \subset E_k$, thus γ_j^i is null-homotopic. This is a contradiction. We conclude that there are no vertical arcs in $A_1 \cap A_2$. \square

Finally by Claim 4.10, $A_1 \cap A_2 \neq \emptyset$. On the other hand by Claim 4.11, $A_1 \cap A_2$ has only vertical arcs or horizontal circles. But Claims 4.12 and 4.13 state that $A_1 \cap A_2$ does not have neither horizontal circles nor vertical arcs, thus $A_1 \cap A_2 = \emptyset$. This is a contradiction. We conclude that there are no descendent inequivalent destabilizations of β , thus there is a unique irreducible descendent. \square

Acknowledgments

I am very grateful to my Ph.D. advisor, Luis Paris, for helpful conversations, pertinent remarks about the manuscript and many ideas embedded in the article. I would also like to thank to the anonymous reviewer who called my attention on some interesting perspectives and for the remarks and style corrections on the text. This work was funded by the National Council on Science and Technology, Mexico (CONCyT), under the graduate fellowship 214898.

References

- [1] Alexander, J.W.; A lemma on systems of knotted curves, Proc. Nat. Acad. Sci. USA, 9 (1923), pp 93–95.
- [2] Bardakov, V.G.; The virtual and universal braids. Fund. Math. 184 (2004), 1–18.
- [3] Bellingeri, P. and Bardakov V. G.; Groups of virtual and welded links, J. Knot Theory Ramifications 23, 1450014 (2014) [23 pages].
- [4] Carter J.S.; How Surfaces Intersect in Space: An Introduction to Topology (Second Edition); Series on Knots and Everything, Volume 2, World Scientific Publishing Company, 1995.
- [5] Carter, J.S., Kamada, S. and Saito, M.; Stable equivalence of knots on surfaces and virtual knot cobordisms, J. Knot Theory Ramifications 11 (2002), pp. 311–322.
- [6] Goussarov, M., Polyak, M. and Viro, O.; Finite-type invariants of classical and virtual knots, Topology, Volume 39, Issue 5, September 2000, pp. 1045–1068.
- [7] Kauffman, L.; Virtual Knots, talks at MSRI Meeting in January 1997 and AMS Meeting at University of Maryland, College Park in March 1997.
- [8] Kauffman, L.H.; Virtual knot theory. European J. Combin. 20 (1999), no. 7, 663–690.
- [9] Kauffman L. and Lambropoulou S.; Virtual braids and the L-move. J. Knot Theory Ramifications, 15(6) (2006), pp. 773–811.
- [10] Kamada, S.; Braid presentation of virtual knots and welded knots, Osaka J. Math. 44 (2007), pp. 441–458.
- [11] Kamada, N. and Kamada, S.; Abstract link diagrams and virtual knots, J. Knot Theory Ramifications 9 (2000), pp. 93–106.
- [12] Kravchenko, O. and Polyak, M.; Diassociative algebras and Milnor’s invariants for tangles, Let. Math. Phys. 95 (2011), pp. 297–316.
- [13] Kuperberg, G.; What is a virtual link?. Algebr. Geom. Topol. 3 (2003), pp. 587–591.
- [14] Markov A. A.; züber die freie Aquivalenz der geschlossen Zöpfe, Recueil Math. Moscou , 1 (1935), pp. 73–78.
- [15] Murasugi K. and Kurpita B.; A study of braids. Mathematics and its Applications, 484. Kluwer Academic Publishers, Dordrecht, 1999. x+272 pp. ISBN: 0-7923-5767-1.
- [16] Polyak, M. and Viro, O.; Gauss diagram formulas for Vassiliev invariants, International Math. Research Notices, No. 11, (1994), pp. 445–453.