



**HAL**  
open science

## Design of Fault-Tolerant Control for Trajectory Tracking

Balazs Németh, Peter Gaspar, Jozsef Bokor, Olivier Sename, Luc Dugard

► **To cite this version:**

Balazs Németh, Peter Gaspar, Jozsef Bokor, Olivier Sename, Luc Dugard. Design of Fault-Tolerant Control for Trajectory Tracking. VSDIA 2012 - 13th Mini Conference on Vehicle System Dynamics, Identification and Anomalies, Nov 2012, Budapest, Hungary. pp. 521 - 528. hal-00939782

**HAL Id: hal-00939782**

**<https://hal.science/hal-00939782>**

Submitted on 30 Jan 2014

**HAL** is a multi-disciplinary open access archive for the deposit and dissemination of scientific research documents, whether they are published or not. The documents may come from teaching and research institutions in France or abroad, or from public or private research centers.

L'archive ouverte pluridisciplinaire **HAL**, est destinée au dépôt et à la diffusion de documents scientifiques de niveau recherche, publiés ou non, émanant des établissements d'enseignement et de recherche français ou étrangers, des laboratoires publics ou privés.

# DESIGN OF FAULT-TOLERANT CONTROL FOR TRAJECTORY TRACKING

Balázs NÉMETH<sup>1</sup>, Péter GÁSPÁR<sup>1</sup>, Zoltán SZABÓ<sup>1</sup>, József BOKOR<sup>1</sup>  
Olivier SENAME<sup>2</sup> and Luc DUGARD<sup>2</sup>

<sup>1</sup>Systems and Control Laboratory, Computer and Automation Research Institute,  
Kende u. 13-17, Budapest, Hungary  
{gaspar.peter;szabo.zoltan}@sztaki.mta.hu

<sup>2</sup>GIPSA-lab, Control Systems Department, 11 rue des Mathématiques, ENSE3,  
BP 46, F-38402 St martin d'Hrescedex, Grenoble France  
{olivier.sename;luc.dugard}@gipsa-lab.grenoble-inp.fr

*Received: November 2., 2012.*

## ABSTRACT

The paper proposes a fault-tolerant integrated control system with the brake and the steering for developing a driver assistance system. The purpose is to design a fault-tolerant control which is able to guarantee the trajectory tracking and lateral stability of the vehicle against actuator fault scenarios. Since both actuators affect the lateral dynamics of the vehicle, in the control design a balance and priority between them must be achieved. The method is extended with a fault-tolerant feature based on a robust LPV method, into which the detected fault information are incorporated. The control design is performed by using the Matlab/Simulink software and the verification of the designed controller is performed by using the CarSim software.

*Keywords:* fault-tolerant control; reconfiguration; fault detection; linear parameter varying control; robust control; autonomous systems.

## 1. INTRODUCTION AND MOTIVATION

The purpose of fault-tolerant trajectory tracking is to follow a road geometry and guarantee the road stability of the vehicle in case of fault events as well. The control system includes the brake and the steering for developing a driver assistance system [1,2]. Since the actuators affect the same dynamics of the vehicle, in the operation of autonomous control systems interference or conflicts may occur between the control components. In the control design the interaction between the actuators must be taken into consideration and a balance between them must be achieved. It has been guaranteed by the integration of control components.

The paper proposes a fault-tolerant control system with several active components for developing a driver assistance system. The purpose of the control is to generate control inputs, such as steering angle, difference in brake forces and longitudinal forces, in different directions. The detected fault information is considered in order to guarantee the reconfigurable and fault-tolerant operation of the vehicle. The paper extends the previously published papers in the integrated control design topic [3,4] with a fault-tolerant reconfiguration strategy.

The paper is organized as follows: in Section 2 the control-oriented formulation of vehicle model is proposed, while the lateral trajectory tracking and the closed-loop interconnection structure are described in Section 3. In Section 4 the architecture and control strategy of fault-tolerant control is presented. Section 5 presents simulation results.

## 2. VEHICLE MODEL FOR TRAJECTORY TRACKING CONTROL

In the design of trajectory-tracking assistance systems it is necessary to guarantee that the vehicle must perform the desired motion of the driver. The control system of the lateral vehicle dynamics assists the driver to track road geometry. It has advantages in critical situations, where the driver is not able to ensure vehicle stability. In trajectory tracking the vehicle is moving in the entire plane of the road, thus both the longitudinal and the lateral dynamics must be taken into consideration as Figure 1 shows.

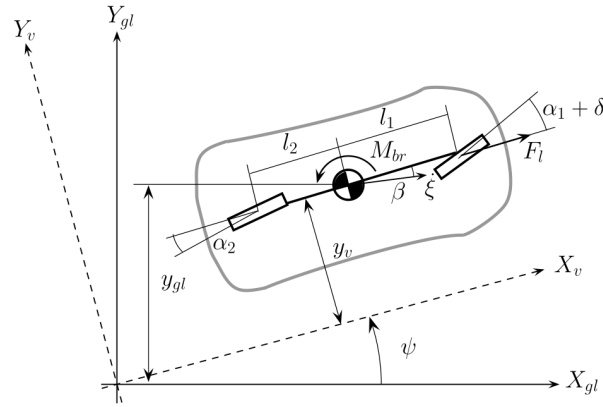

Figure 1: Lateral dynamic model of vehicle

Two actuators are used in the system, i.e., the front-wheel steering angle  $\delta$  and the differential brake torque  $M_{br}$ . In most of the lateral control problems, the lateral dynamics of the vehicle can be approximated by the linear bicycle model of the vehicle:

$$J\ddot{\psi} = C_1 l_1 \alpha_f - C_2 l_2 \alpha_r + M_{br} \quad (1)$$

$$mv(\dot{\psi} + \dot{\beta}) = C_1 \alpha_f + C_2 \alpha_r \quad (2)$$

where  $m$  is the mass,  $J$  is the yaw-inertia of the vehicle,  $l_1$  and  $l_2$  are geometric parameters,  $C_1$ ,  $C_2$  are cornering stiffnesses,  $\dot{\psi}$  is the yaw rate of the vehicle,  $\beta$  is the side-slip angle. Moreover,  $\alpha_f = -\beta + \delta - l_1 \cdot \dot{\psi}/v$  and  $\alpha_r = -\beta + l_2 \cdot \dot{\psi}/v$  are the tyre side slip angles at the front and rear, respectively.

Two control systems will be designed based on the state space representation of the vehicle:

$$\dot{x} = A(\rho)x + B(\rho)u \quad (3)$$

where the state vector consists of the yaw-rate and the side-slip angle of the vehicle  $x = [\dot{\psi} \ \beta]^T$ . In the brake control case the input of the system is  $u = M_{br}$ , while in the steering control case the input is  $u = \delta$ . The measured output of both systems is the yaw-rate,  $y = \dot{\psi}$ . Note that in the operation of the driver assistance system the reference signal of the yaw-rate,  $\dot{\psi}_{ref}$ , is also required.

### 3. LPV-BASED CONTROL DESIGN STRATEGY

In the driver assistance system the performance is the minimization of the tracking error of the yaw-rate

$$z_1 = [\dot{\psi}_{ref} - \dot{\psi}]^T \rightarrow min! \quad (4)$$

where  $\dot{\psi}_{ref}$  is the reference yaw rate defined by the driver. Simultaneously, actuator saturations must be avoided. The maximal control input of the steering is determined by their physical construction limits, while in case of the braking system the constraints are determined by the tyre-road adhesion. These constraints will be built into the weighting strategy applied in the control design. The other performance of the system considering the control input is formulated as

$$z_2 = |u| \rightarrow min! \quad (5)$$

The generation of the different actuators is based on the following weighting strategy. The weighting for the front wheel steering and that for the brake yaw-moment are

$$W_{act,st} = \rho_{st} / \delta_{max} \quad (6)$$

$$W_{act,Mbr} = \rho_{br} / M_{brmax} \quad (7)$$

respectively, where  $\delta_{max}$  is determined by the constructional maximum of the steering, while  $M_{brmax}$  is the maximum of the brake yaw-moment. Weighting factors  $\rho_{st}, \rho_{br}$  are chosen to influence the actuation of the steering and the brake yaw-moment. The formulated  $W_{act}$  and  $W_{act,Mbr}$  weights are considered in the control design to influence actuator intervention. The actuator selection procedure and the priorities of actuators depending on vehicle dynamic situations can be found in [5].

The control design is based on a weighting strategy, which is formulated through a closed-loop interconnection structure, see Figure 2. In the trajectory tracking problem the yaw-rate reference signal is introduced in order to guarantee the tracking of the road geometry:  $R = [\dot{\psi}_{ref}]^T$ . Usually the purpose of weighting function  $W_p$  is to define the performance specifications in such a way that a trade-off is guaranteed between them. The weighting function for performance specification is selected in a second-order proportional form. The purpose of the weighting functions  $W_w$  and  $W_n$  is to reflect the disturbance and sensor noises. Weighting functions,  $W_{act}$ , are applied for the actuators one for the brake yaw-moment and the other one for the steering angle.

The control design is based on the LPV method that uses parameter-dependent Lyapunov functions, see [6]. The quadratic LPV performance problem is to choose the parameter-varying controller  $K(\rho)$  in such a way that the resulting closed-loop system is quadratically stable and the induced  $L_2$  norm from the disturbance and the performances is less than the value  $\gamma$ . The existence of a controller that solves the quadratic LPV  $\gamma$ -performance problem can be expressed as the feasibility of a set of

Linear Matrix Inequalities (LMIs), which can be solved numerically. Finally, the state space representation of the LPV control  $K(\rho)$  is constructed, see [7]. When the controller has been synthesized, the relation between the state and the variable is used such that a nonlinear controller is obtained. Stability and performance are guaranteed by the design procedure.

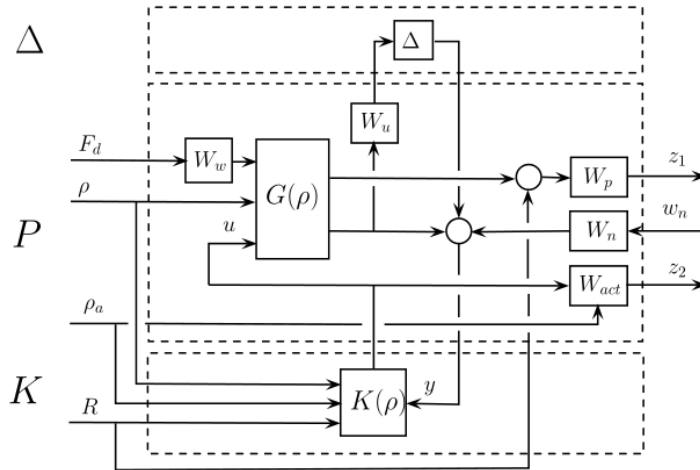

Figure 2: Closed-loop interconnection structure

#### 4. ARCHITECTURE AND RECONFIGURATION OF THE CONTROL SYSTEM

The purpose of control design is to calculate the necessary front steering angle and brake yaw moment. The design of this upper level controller is based on the LPV method. Then the designed longitudinal force and brake yaw moment are distributed between the four wheels of the vehicle. Moreover, a third layer is also necessary since the required control forces must be tracked by using a low-level controller. This controller transforms the wheel forces and the values of the steering angle into a real physical parameter of the actuator. These components are implemented by Electronic Control Units (ECUs).

The design of a low-level steering controller might use more specific techniques that fit the specific nonlinear properties of the actuator. The steer-by-wire front steering system transforms the steering angle into a real physical parameter of the actuator. The real physical input of the system is the Pulse Width Modulated (PWM) signal of the electric servo motor, which moves the rack. The physical construction of electric steering has several variations, see e.g. [8]. Figure 3 shows the architecture of the low-level steering controller.

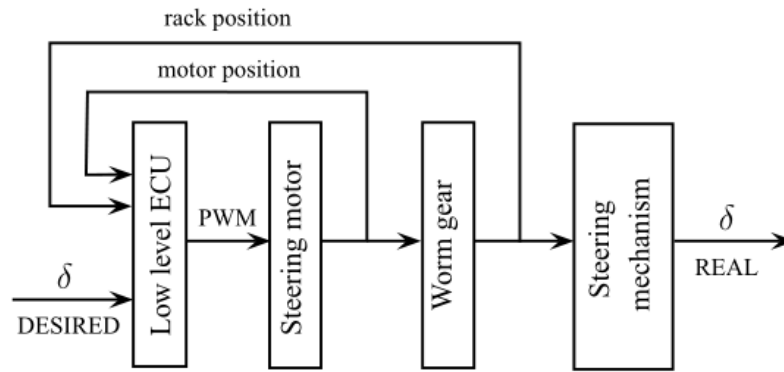

Figure 3: The low-level driveline control structure

The architecture of the controlled supervisory system is shown in Figure 4. In the fault-tolerant scheme fault detection and isolation filters (FDIs) for actuators are assumed to be used. In this paper two kind of actuator faults are considered: the fault of the steering control system and the fault of the braking circuits. There may be various fault scenarios, e.g the leakage of the hydraulic systems in braking or steering servo, or the steering mechanism becomes jammed. The different change in the operation of an actuator makes it possible to realize the detection of fault. The filters are able to detect different types of faults in the operation of the actuators. An  $H_\infty$  method to design a fault detection and isolation LPV filter was presented by [9].

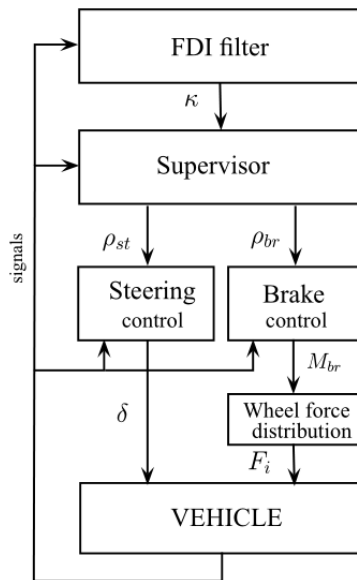

Figure 4: Architecture of fault-tolerant control system

Two actuators are operated in cooperation in order to provide a reconfigurable fault-tolerant control system. In case of a detected fault either the brake yaw moment  $M_{br}$  or the front wheel steering  $\delta$  can be changed, which have similar dynamic effects.

When a fault occurs in the operation of the steering system, all the lateral control tasks must be realized by using the braking system with the generation of the brake

yaw moment  $M_{br}$ . In the fatal error in the operation of the steering system the weight of steering is masked:

$$\rho_{st} = 0 \quad (11)$$

When a fault occurs in the operation of a brake circuit the actuated brake yaw-moment is reduced. Moreover, the reduction of the brake yaw-moment is asymmetric. For example, in case of the fault of a brake circuit on the left-hand side of the vehicle, the generated positive brake yaw-moment is reduced, or it is zero. In this case steering is activated to substitute for the actuation of braking and provide trajectory tracking. However, the negative  $M_{br}$  can be realized by the healthy right brake circuits. Consequently, the weight of braking  $\rho_{br}$  depends on the sign of the desired  $M_{br}$ . In the case of a left-hand-side brake circuit fault, positive  $M_{br}$  is not allowed, therefore  $\rho_{br} = 0$ . However, if  $M_{br} < 0$  then  $\rho_{br} > 0$ . The actual modification of  $\rho_{br}$  is based on a design parameter:

$$\rho_{br,new} = \kappa_i \cdot \rho_{br} \quad (12)$$

where  $\kappa_i$  is selected according to Figure 5.

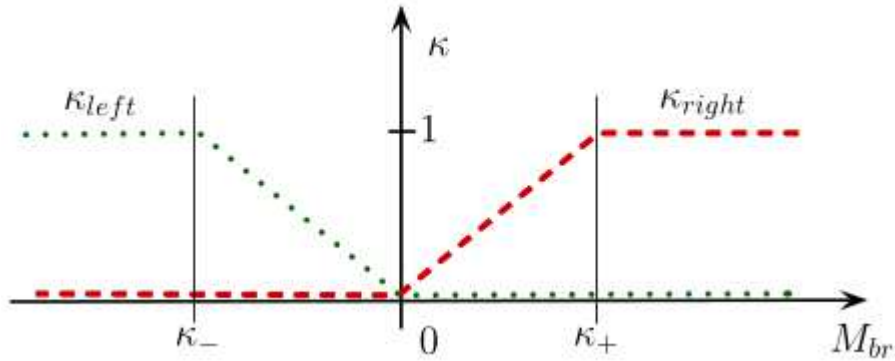

Figure 5: Weighting functions at brake faults

## 5. SIMULATION RESULTS

The vehicle is traveling along a predefined road, while the integrated control system supports the driver to guarantee trajectory tracking. During the simulations different faults occur and these faulty cases are compared with a healthy simulation. A typical E-Class automobile is applied in the simulation. The mass of the 6-gear car is 2023 kg its engine power is 300 kW (402 hp). The width of the track is 1605 mm and the wheel-base is 3165 mm. In the simulation examples the vehicle is traveling along a section of Waterford Michigan Race Track with a given velocity, which are shown in Figure 6.

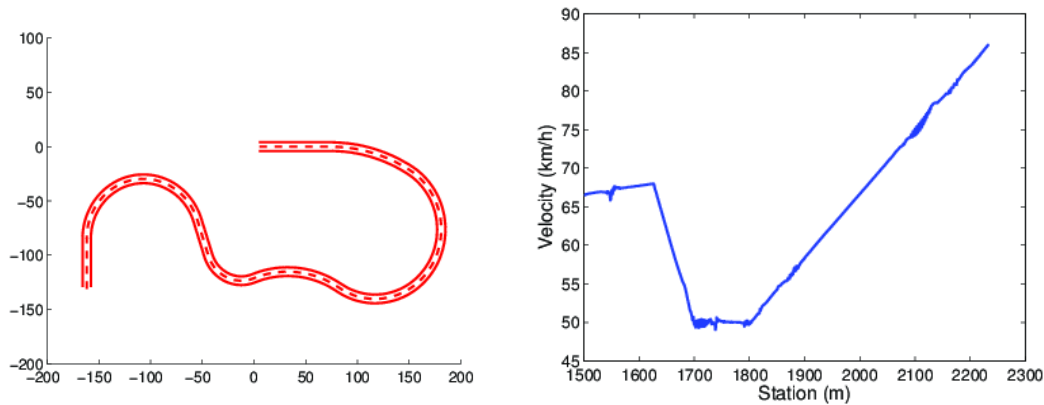

Figure 6: Trajectory and velocity of vehicles

In the first simulation a steering fault occurs in the controlled system. Note that the driver assistance system is not able to modify front wheel steering angle, but the driver can steer the front wheels. The control system actuates only brake yaw-moment  $M_{br}$ . Figure 7 shows the faulty simulation case compared with a healthy one. The lateral error of the system and the yaw-rate tracking are illustrated in Figure 7(a) and Figure 7(b).

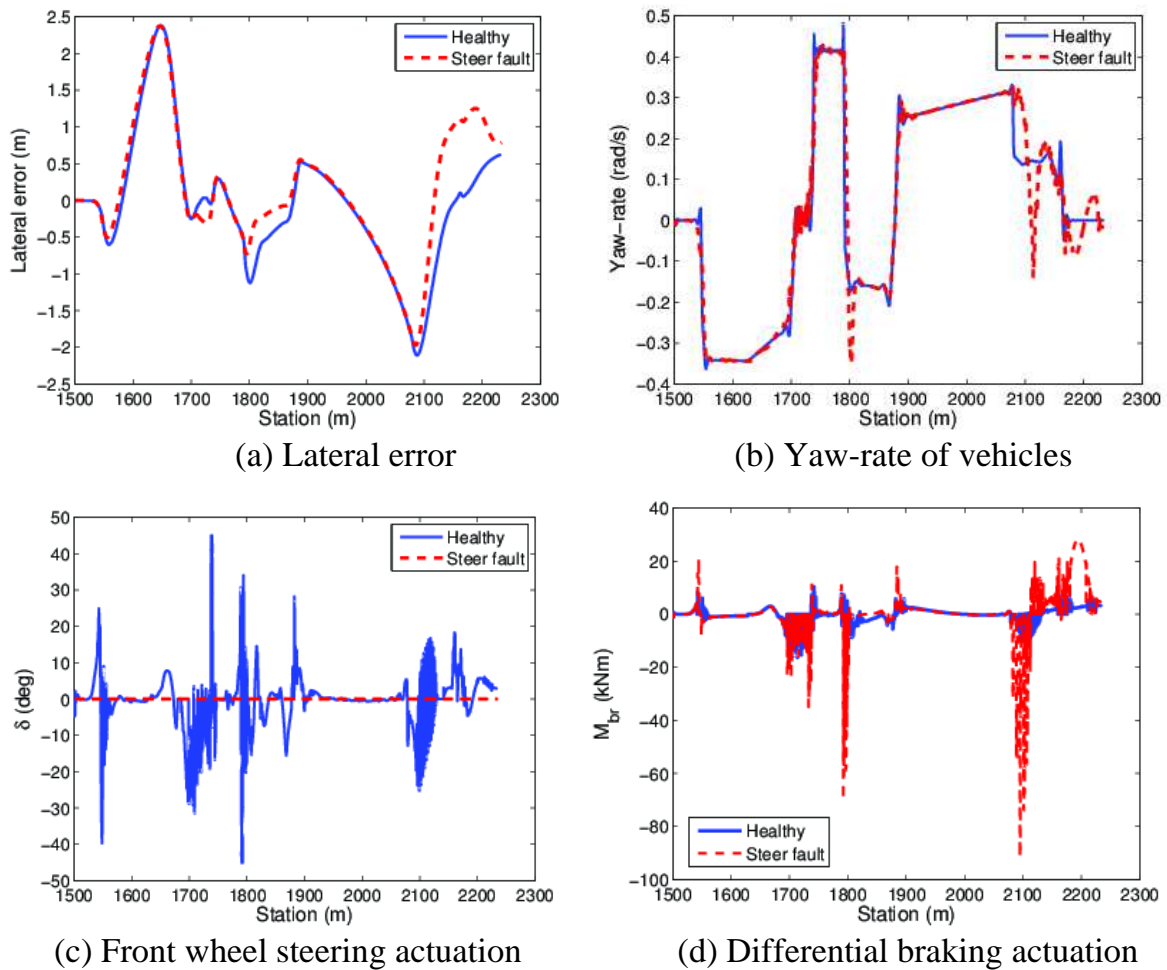

Figure 7: Steering fault example compared to healthy scenario



As Figure 7(a) shows, the integrated control system is able to tolerate a steering fault, the lateral error and the yaw-rate of faulty simulation results are close to the healthy cases. It is the consequence of the appropriate reconfiguration of the actuators. The largest degradation difference is reached at the last curve. In Figure 7(c) and Figure 7(d) the steering and braking actuation of the controller are shown. Through the fault of the steering the actuation of  $M_{br}$  and brake pressures are increased.

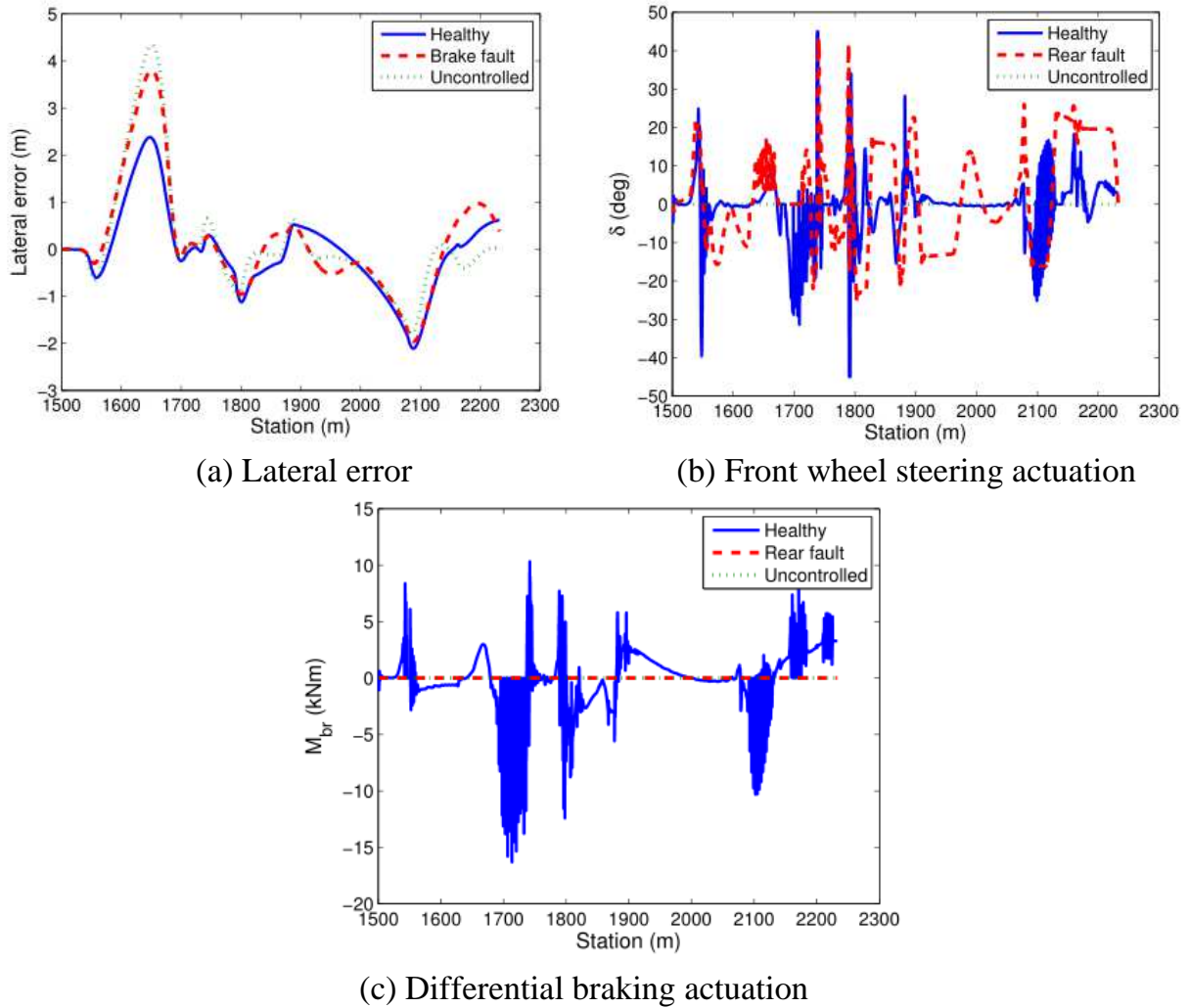

Figure 8: Fatal error in brake system

In the second simulation example in both of the rear brake circuits are faults occurred. In Figure 8 the effects of brake faults are shown. In the first curve the lateral error of the vehicle increases significantly, because only steering actuator can be actuated during the vehicle maneuver, see Figure 8(b). Since differential braking actuation cannot be used because of the fault, see Figure 8(c), the intervention of brake must be replaced by additional steering angle. However, Figure 8(a) illustrates that lateral error of the vehicle in faulty scenario is smaller, compared to an uncontrolled vehicle. It means that the integrated control system can be used effectively not only in healthy, but also in faulty situations as well.

## 6. CONCLUSION

The paper has proposed the design of a supervisory integrated reconfigurable driver assistance system which is able to track road geometry. The actuators of the control system are the front-wheel steering and the brake yaw-moment. The paper extends the control design with an actuator selection procedure, which is built in the design of the supervisor of the system. The control design of actuators is based on the robust optimal LPV method, in which both performance specifications and model uncertainties are taken into consideration. A possible realization of the required control system has also been presented. The integrated system makes it possible to achieve a reconfigurable and fault-tolerant system. The fault-tolerance of the controlled system is demonstrated by simulation examples.

## 7. ACKNOWLEDGEMENT

This work was supported by the TÁMOP-4.2.2.A-11/1/KONV-2012-0012: Basic research for the development of hybrid and electric vehicles. and the PICS-CROTALE projects.

## 8. REFERENCES

- [1] **Zin, A. - Sename, O. - Gáspár, P. - Szabó, Z. - Dugard, L. – Bokor, J.:** An LPV/Hinf active suspension control for global chassis technology: Design and performance analysis. *Vehicle System Dynamics*, 2008. (p.889-912, vol. 46)
- [2] **Rajamani, R. - Tan, H.S. - Law, B.K. – Zhang, W.B.:** Demonstration of integrated longitudinal and lateral control for the operation of automated vehicles in platoons. *IEEE Transactions on Control Systems Technology*, 2000. (p.695–708, vol. 8)
- [3] **Németh, B. – Gáspár, P. – Szabó, Z. – Bokor, J. – Sename, O. – Dugard, L.:** Model-Based Robust Control Design of Integrated Vehicle tracking System. *Proc. of the 12th VSDIA-Symposium*. 2010. (p.485-492)
- [4] **Németh, B. – Gáspár, P.:** Design of actuator interventions in the trajectory tracking for road vehicles. *50th IEEE Conference on Decision and Control – European Control Conference*. Orlando, Florida, USA, 2011.
- [5] **Gáspár, P. – Németh, B. – Bokor, J.:** Design of an integrated control for driver assistance systems based on LPV methods. In.: *American Control Conference*. Montréal, Canada. 2012.
- [6] **Wu, F. - Yang, X. H. - Packard, A. – Becker, G.:** Induced  $l_2$ -norm control for LPV systems with bounded parameter variation rates. *International Journal of Nonlinear and Robust Control*. 1996. (p. 983–998, vol. 6)
- [7] **Packard, A. - Balas, G.:** Theory and application of linear parameter varying control techniques. *American Control Conference, Workshop I*, Albuquerque, New Mexico, 1997.

- [8] **Claeys, X. - Canudas de Wit, C. – Bechart, H.:** Modeling and control of steering actuator for heavy duty vehicle. European Control Conference, 1999.
- [9] **Bokor, J. – Balas, G.:** Detection filter design for LPV systems - a geometric approach. Automatica, 2004. (p.511–518, vol. 40)