



**HAL**  
open science

## Fault-tolerant control design for trajectory tracking in driver assistance systems

Balázs Németh, Peter Gaspar, Jozsef Bokor, Olivier Sename, Luc Dugard

► **To cite this version:**

Balázs Németh, Peter Gaspar, Jozsef Bokor, Olivier Sename, Luc Dugard. Fault-tolerant control design for trajectory tracking in driver assistance systems. SAFEPROCESS 2012 - 8th IFAC Symposium on Fault Detection, Supervision and Safety for Technical Processes, Aug 2012, Mexico City, Mexico. pp.186-191, 10.3182/20120829-3-MX-2028.00102 . hal-00939737

**HAL Id: hal-00939737**

**<https://hal.science/hal-00939737>**

Submitted on 30 Jan 2014

**HAL** is a multi-disciplinary open access archive for the deposit and dissemination of scientific research documents, whether they are published or not. The documents may come from teaching and research institutions in France or abroad, or from public or private research centers.

L'archive ouverte pluridisciplinaire **HAL**, est destinée au dépôt et à la diffusion de documents scientifiques de niveau recherche, publiés ou non, émanant des établissements d'enseignement et de recherche français ou étrangers, des laboratoires publics ou privés.

# Fault-tolerant control design for trajectory tracking in driver assistance systems <sup>★</sup>

Balázs Németh\*, Péter Gáspár\*, József Bokor\*,  
Olivier Sename\*\*, Luc Dugard\*\*

\* *Computer and Automation Research Institute, Hungarian Academy of Sciences, Hungary; E-mail: {bnemeth;gaspar;bokor}@sztaki.hu*

\*\* *GIPSA-lab, Grenoble Institute of Technology, France  
E-mail: {olivier.sename;luc.dugard}@gipsa-lab.grenoble-inp.fr*

---

**Abstract:** The paper proposes a control system with the brake and the steering for developing a driver assistance system. The purpose is to design a cruise control method to track the road geometry with a predefined velocity and guarantee the road stability of the vehicle simultaneously. An actuator selection method is developed in the control design, in which the actuator limits, energy requirements and vehicle operations are taken into consideration. The method is extended with a fault-tolerant feature based on a robust LPV method, into which the actuator selection procedure and the detected fault information are incorporated. The operation of the reconfigurable control system is illustrated through various vehicle manoeuvres.

*Keywords:* fault-tolerant control; reconfiguration; fault detection; linear parameter varying control; robust control; autonomous systems.

---

## 1. INTRODUCTION AND MOTIVATION

The purpose of trajectory tracking is to follow a road geometry with a velocity defined by the driver and guarantee the road stability of the vehicle simultaneously. Since the actuators affect the same dynamics of the vehicle, in the operation of control systems interference or conflicts may occur between the control components. In the control design the interaction between the actuators must be taken into consideration and a coordination between them must be achieved. An integrated control system is designed in such a way that the effects of a control system on other vehicle functions are taken into consideration in the design process.

The demand for vehicle control methodologies including several control components arises at several research centers and automotive suppliers. Recently, important survey papers have also been presented in this topic, see e.g. Yu et al. (2008). A vehicle control with four-wheel-distributed steering and four-wheel-distributed traction/braking systems was proposed by Ono et al. (2006). A yaw stability control system in which an active torque distribution and differential braking systems were used was proposed by Zhang et al. (2009). Differential braking and front steering to enhance the vehicle yaw stability and the lateral vehicle dynamics was proposed by Doumiati et al. (2010). An integrated control that involves both four-wheel steering and yaw moment control was proposed by Jianyong et al. (2007). Active steering and suspension controllers were also integrated to improve yaw and roll stability Pousot-

Vassal et al. (2011). A global chassis control involving an active suspension and ABS was proposed by Gáspár et al. (2010); Zin et al. (2008). The driveline system and the brake were integrated in Rajamani et al. (2000). A possible integration of the brake, steering and suspension system was presented by Trachtler (2004).

The paper proposes a control system with two active components for developing a driver assistance system. The purpose of the control is to generate control inputs, such as the steering angle and the difference in brake forces. Since both the actuators affect the lateral dynamics of the vehicle, in the control design a balance and priority between them must be achieved. An actuator selection method is applied in the control design. Moreover, detected fault information is also considered in order to guarantee the reconfigurable and fault-tolerant operation of the vehicle.

The paper is organized as follows: in Section 2 the vehicle model and the longitudinal-lateral trajectory tracking are formalized. In Section 3 the closed-loop interconnection structure is formalized and an actuator selection method is applied. In Section 4 the architecture of the control system and the fault-tolerant control are presented. In Section 5 simulation results are presented.

## 2. VEHICLE MODEL FOR THE TRAJECTORY TRACKING

In the design of trajectory-tracking assistance systems it is necessary to guarantee that the vehicle must perform the desired motion of the driver. The control system of the lateral vehicle dynamics assists the driver in tracking road geometry. It has advantages in critical situations, in which the driver is not able to ensure vehicle stability. In trajectory tracking the vehicle is moving in the entire plane

---

<sup>★</sup> The research was supported by the Hungarian National Office for Research and Technology through the project "Innovation of distributed driver assistance systems for a commercial vehicles platform" (TECH\_08\_2/2-2008-0088).

of the road, thus both the longitudinal and the lateral dynamics must be taken into consideration as Figure 1 shows.

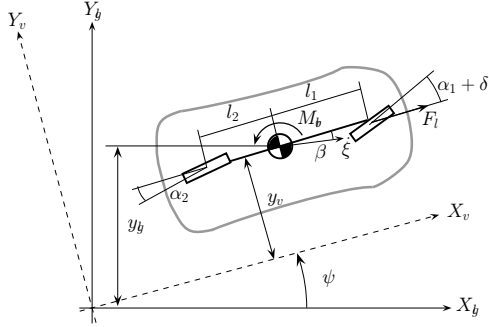

Fig. 1. Lateral dynamic model of vehicle

Two actuators are used in the system, i.e., the front-wheel steering angle  $\delta$  and the differential brake torque  $M_{br}$ . In most of the lateral control problems, the lateral dynamics of the vehicle can be approximated by the linear bicycle model of the vehicle:

$$J\dot{\psi} = C_1 l_1 \alpha_f - C_2 l_2 \alpha_r + M_{br} \quad (1a)$$

$$mv(\dot{\psi} + \dot{\beta}) = C_1 \alpha_f + C_2 \alpha_r \quad (1b)$$

where  $m$  is the mass,  $J$  is the yaw-inertia of the vehicle,  $l_1$  and  $l_2$  are geometric parameters,  $C_1$ ,  $C_2$  are cornering stiffnesses,  $\dot{\psi}$  is the yaw rate of the vehicle,  $\beta$  is the side-slip angle. Moreover,  $\alpha_f = -\beta + \delta - l_1 \cdot \dot{\psi}/v$  and  $\alpha_r = -\beta + l_2 \cdot \dot{\psi}/v$  are the tyre side slip angles at the front and rear, respectively.

Two control systems will be designed based on the state space representation of the vehicle:

$$\dot{x} = Ax + Bu \quad (2)$$

where the state vector consists of the yaw-rate and the side-slip angle of the vehicle  $x = [\dot{\psi} \ \beta]^T$ . In the brake control case the input of the system is  $u = M_{br}$ , while in the steering control case the input is  $u = \delta$ . The measured output of both systems is the yaw-rate,  $y = \dot{\psi}$ .

This approach is suitable in the decentralized control concept, where the components are designed independently. The advantage of this solution is that the components with their sensors and actuators can be designed by the suppliers independently. Since the controllers guarantee performances only locally, the stability and performances of the entire closed-loop system must also be guaranteed. It is required to perform an analysis step in the robust control framework on a global level.

### 3. CONTROL DESIGN BASED ON WEIGHTING FUNCTIONS

#### 3.1 Performance specifications

In the driver assistance system the performance is the minimization of the tracking error of the yaw-rate

$$z_1 = [\dot{\psi}_{ref} - \dot{\psi}]^T \rightarrow \min! \quad (3)$$

where  $\dot{\psi}_{ref}$  is the reference yaw rate defined by the driver. The reference yaw-rate of the controller can be calculated from the steering wheel angle, see Pacejka (2004).

Simultaneously, actuator saturations must be avoided. The maximum control input of the steering is determined by its physical construction limits, while in the case of the braking system the constraints are determined by the tyre-road adhesion. These constraints will be built into the weighting strategy applied in the control design. The other performance of the system in terms of the control input is formalized as

$$z_2 = |u| \rightarrow \min! \quad (4)$$

The control design is based on a weighting strategy, which is formalized through a closed-loop interconnection structure, see Figure 2. In the trajectory tracking problem the yaw-rate reference signal is introduced in order to guarantee the tracking of the road geometry:  $R = \dot{\psi}_{ref}$ . The role of the weighting functions is to define performance specifications, reflect disturbances and uncertainty. Since the coordination between the actuators and creating priority between them are in the focus of the paper, in the following the design of the weighting functions for actuators is presented.

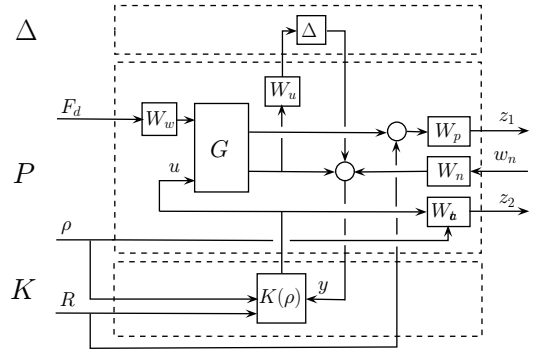

Fig. 2. Closed-loop interconnection structure

#### 3.2 Weighting function for the actuators

In this section an actuator selection method is developed in the control design, in which the actuator limits, energy requirements and vehicle operations are taken into consideration. Since the steering angle and the brake moment actuators affect the same dynamics of the vehicle, a balance between them must be achieved.

First the steering operation is analyzed. Steering has a construction limit, i.e., the value of front-wheel steering can not exceed an upper bound. In order to avoid a steering limit differential braking must be increased. During driving the steering angle is used to handle the lateral dynamics. Moreover, during close to the limit of skidding steering is also preferred to the brake.

Second the brake intervention is considered. The brake moment is limited by the adhesion value between the road and the tire. It is necessary to prevent the skidding of tires, thus in case of skidding the differential braking must be reduced, while the yaw-motion of vehicle must be controlled by front-wheel steering. By using differential braking the velocity of the vehicle is decreased. Thus, during driving the use of differential braking must be avoided and front-wheel steering is preferred. During deceleration, however,

the brake is already being used, thus the lateral dynamics is handled by the braking for practical reasons.

Two weighting factors  $\rho_{st}, \rho_{br}$  are introduced in order to take into consideration the influence of the steering and the brake moment. These are built into the weighting functions applied to the control design. The weighting for the front wheel steering and that for the brake yaw-moment are

$$W_{act,st} = \rho_{st} / \delta_{max} \quad (5a)$$

$$W_{act,Mbr} = \rho_{br} / M_{brmax} \quad (5b)$$

respectively, where  $\delta_{max}$  is determined by the constructional maximum of the steering system, while  $M_{brmax}$  is the maximum of the brake yaw-moment. Figure 3 shows the characteristics of the weighting factors.

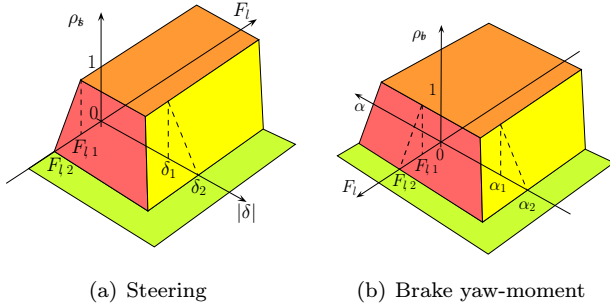

Fig. 3. Selection of weights  $\rho_{st}, \rho_{br}$

In the case of driving the front wheel steering is actuated, which is determined by factor  $\rho_{st}$ , see Figure 3(a). The value is reduced between  $\delta_1$  and  $\delta_2$ , which represents the constructional criterion of the steering system. In the case of braking the tyre longitudinal slip angle affects factor  $\rho_{br}$ , see Figure 3(b). In this interval differential braking is preferred for practical reasons. Reducing tyre skidding requires an interval. Therefore two parameters are designed:  $\alpha_1$  and  $\alpha_2$  are applied to prevent the skidding of tyres. An interval to prevent chattering between steering and differential braking:  $F_{l,1}$  and  $F_{l,2}$  is also required.

In the following it is assumed that the longitudinal slip and the longitudinal force are measured or estimated, these weighting factors are available during the journey. The model, which is the basis of the control design, is an LPV form and the control design is based on the LPV method. The purpose of the quadratic LPV design method is to choose the parameter-varying controller  $K(\rho)$  in such a way that the resulting closed-loop system is quadratically stable and the induced  $\mathcal{L}_2$  norm from the disturbance and the performances is less than the value  $\gamma$ . Stability and performance are guaranteed by the design procedure, see Bokor and Balas (2005); Packard and Balas (1997); Wu et al. (1996).

#### 4. DESIGN OF THE FAULT-TOLERANT CONTROL SYSTEM

##### 4.1 Architecture of the control system

The purpose of control design is to calculate the necessary front steering angle and brake yaw moment. The design of this upper level controller is based on the LPV method. The designed longitudinal force and brake yaw moment are distributed between the four wheels of the vehicle.

Moreover, a third layer is also necessary since the required control forces must be tracked by using a low-level controller. This controller transforms the wheel forces and the values of the steering angle into a real physical parameter of the actuator. These components are implemented by Electronic Control Units (ECUs).

The design of a low-level steering controller might use more specific techniques that fit the specific nonlinear properties of the actuator. The steer-by-wire front steering system transforms the steering angle into a real physical parameter of the actuator. The real physical input of the system is the Pulse Width Modulated (PWM) signal of the electric servo motor, which moves the rack. The physical construction of electric steering has several variations, see e.g. Claeys et al. (1999). Figure 4 shows the architecture of the low-level steering controller.

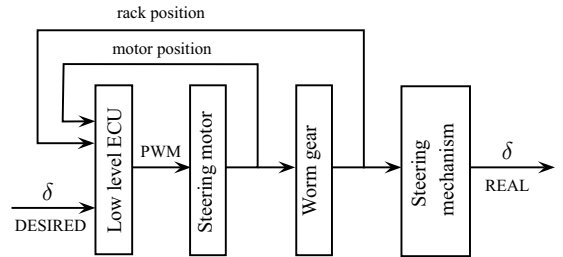

Fig. 4. The low-level driveline control structure

The architecture of the controlled supervisory system is shown in Figure 5.

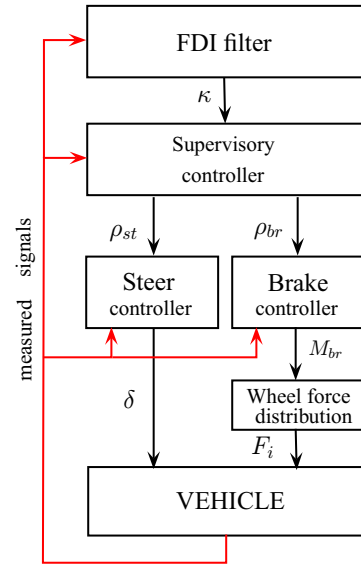

Fig. 5. Architecture of control system

In the fault-tolerant scheme fault detection and isolation (FDI) filters for actuators are assumed to be used. In this paper two kinds of actuator faults are considered: the fault of the steering control system and the fault of the braking circuits. There may be various fault scenarios, e.g. the leakage of the hydraulic systems in the braking or steering servo, or the steering mechanism becomes jammed. The

different changes in the operation of an actuator make it possible to realize the detection of a fault.

The filters are able to detect different types of faults in the operation of the actuators. An  $\mathcal{H}_\infty$  method to design a fault detection and isolation (FDI) LPV filter was presented by Edelmayer et al. (1997). The geometric approaches often lead to successful detection filter design, for details see Bokor and Balas (2004). The selection of the performance weights in the design of FDI filters has been applied to vehicle systems, see in Gáspár et al. (2012). This paper focuses only on the design of fault-tolerant control and it is assumed that the FDI filters have been designed and they are available.

#### 4.2 Modification of the weighting functions

Two actuators are operated in cooperation in order to provide a reconfigurable fault-tolerant control system. In case of a detected fault either the brake yaw moment  $M_{br}$  or the front wheel steering  $\delta$  can be changed with similar dynamic effects.

When a fault occurs in the operation of the steering system, all the lateral control tasks must be realized by using the braking system with the generation of the brake yaw moment  $M_{br}$ . If fatal error occurs in the operation of the steering system the weight of steering is masked:  $\rho_{st} = 0$ .

When a fault occurs in the operation of a brake circuit the actuated brake yaw-moment is reduced. Moreover, the reduction of the brake yaw-moment is asymmetric. For example, in the case of a fault of a brake circuit on the left-hand side of the vehicle, the generated positive brake yaw-moment is reduced, or it is zero. In this case steering is activated to substitute for the actuation of braking and provide trajectory tracking. However, the negative  $M_{br}$  can be realized by the healthy right-hand-side brake circuits. Consequently, the weight of braking  $\rho_{br}$  depends on the sign of the desired  $M_{br}$ . In the case of a left-hand-side brake circuit fault, positive  $M_{br}$  is not allowed, therefore  $\rho_{br} = 0$ . However, if  $M_{br} < 0$  then  $\rho_{br} > 0$ . The actual modification of  $\rho_{br}$  is based on a design parameter:  $\rho_{br,new} = \kappa_i \cdot \rho_{br,m}$  where  $\kappa_i$  is a weighting factor.

#### 4.3 Quadratic stability of the entire control system

The stability of the individual controllers is guaranteed by the design method. The global control system contains two controllers, the brake and the steering. The global system uses two scheduling variables  $\rho = [\rho_{br}, \rho_{st}]$ . According to Figure 3, these factors have limits. When these controllers are used simultaneously it is necessary to guarantee the stability of the global closed-loop system.

A common Lyapunov function for the closed-loop systems must exist. The following affine parameter-dependent closed-loop system is given, see Scherer and Weiland (2000); Boyd et al. (1997):

$$\dot{x}(t) = A(\rho) x(t). \quad (6)$$

where  $A(\rho) = A_0 + \rho_1 A_1 + \dots + \rho_4 A_4$ . For the stability of the system (6) it is necessary to guarantee that all trajectories of system  $A$  converge to zero as  $t \rightarrow \infty$ . A sufficient condition for this is the existence of a quadratic function

$V(\xi) = \xi^T P \xi$ ,  $P > 0$ , which decreases along every nonzero trajectory of (6). If there exists such a  $P$ , then (6) is said to be quadratically stable and  $V$  is called a quadratic Lyapunov function. The necessary and sufficient condition for quadratic stability of system (6) for all of  $A_i$  is

$$A_{cl,i}^T P + P A_{cl,i} < 0; P > 0; i = 1, \dots, n \quad (7)$$

Therefore it is necessary to find a  $V$  common Lyapunov function for all of the closed-loop systems which can guarantee the global stability of the systems in every scheduling variable.

The matrices of the closed-loop system  $A_{cl,i}$  are computed using the next formula:

$$A_{cl,i} = \begin{bmatrix} A + B_2 D_{ci} C_{2i} & B_2 C_{ci} \\ B_{ci} C_2 & A_{ci} \end{bmatrix} \quad (8)$$

where  $A$ ,  $B_2$ ,  $C_2$  are the state space representation of the plant,  $A_{ci}$ ,  $B_{ci}$ ,  $C_{ci}$ ,  $D_{ci}$  are the state-space representations of the controllers. The aim is to find a solution to  $P > 0$ . To analyze the global stability of the LTI systems,

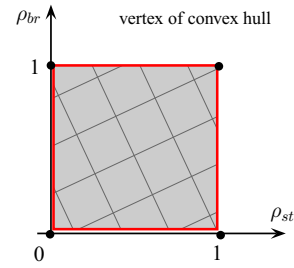

Fig. 6. Convex hull of LTI systems

$\text{Co}\{A_1, \dots, A_4\}$  is covered by the convex hull of finitely many matrices  $A_{cl,i}$ . According to the system, the convex hull contains 4 LTI systems, see Figure 6. For the analysis of global stability this convex hull can be used.

## 5. SIMULATION RESULTS

In this section the fault tolerance of the control system is illustrated through simulation examples. Several software packages are used for the design and analysis of the controlled system. The control design is performed by using the Matlab/Simulink software. The verification of the designed controller is performed by using the CarSim software. In this package the model of the actual road vehicle dynamics is represented with high accuracy.

The vehicle is traveling along a predefined road, while the integrated control system supports the driver to guarantee trajectory tracking. During the simulations different faults occur and these faulty cases are compared with a healthy simulation. A typical E-Class automobile is applied in the simulation. The mass of the 6-gear car is 2023 kg, its engine power is 300 kW (402 hp). The width of the track is 1605 mm and the wheel-base is 3165 mm. In the simulation examples the vehicle is traveling along a section of Waterford Michigan Race Track, which is shown in Figure 7(a). The velocity of the vehicle changes along its route as Figure 7(b) shows.

In the first simulation a steering fault occurs in the controlled system. Note that the driver assistance system is not able to modify front wheel steering angle, but the

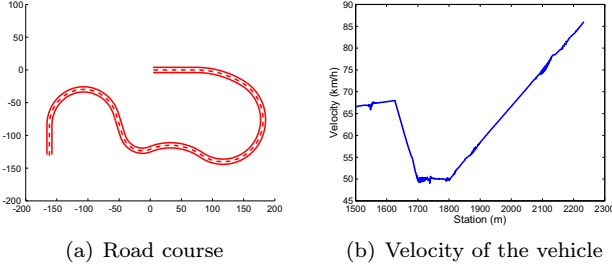

Fig. 7. Trajectories of vehicles

driver can steer the front wheels. The control system actuates only brake yaw-moment  $M_{br}$ . Figure 8 shows the faulty simulation case compared with a healthy one. The lateral error of the system and the yaw-rate tracking are illustrated in Figure 8(a) and Figure 8(b). The integrated control system can tolerate a steering fault, the lateral error and the yaw-rate of faulty simulation results are close to the healthy cases. The largest difference is at the last bend. In this bend the longitudinal slip of the wheels reach  $-1$ , while in the fault-free case it can be reduced using the actuation of the front wheel steering. The reason for the skidding is the increased brake pressures, compared to the fault-free case, see Figure 8(e) and Figure 8(f). In Figure 8(c) and Figure 8(d) the steering and braking actuations of the controller are shown. If a fault occurs in the steering the actuation of  $M_{br}$  and the brake pressures are increased. Figures 8(g) and Figures 8(h) illustrate the change in the weighting  $\rho$  of controllers. In the case of a steering fault the weight of steering  $\rho_{st}$  is equal to zero, while the weight of braking is influenced by skidding.

In the second simulation example one of the rear brake circuits fails. In Figure 9(a) the effect of brake faults is shown. In the first bend the vehicle turns right, which means that the rear right-hand-side wheel brake is actuated to perform the maneuver. Therefore rear right-hand-side brake circuit fault increases the lateral error. In the case of bends to the left the fault of the rear left-hand-side wheel circuit increases the lateral error. Figure 9(b) illustrates the steering wheel angle, which is actuated by the driver. It can be seen that the fault in the brake system necessitates faster and more intensive intervention by the driver. A deterioration of the braking effect induces an increase in the front wheel steering to perform the maneuver, see Figure 9(c). If a fault occurs in the brake the actuated  $M_{br}$  moment has a limitation, as shown in Section 4. In the case of a left-hand-side brake circuit fault the vehicle is not turned anti clockwise, therefore positive  $M_{br}$  is not allowed and vice versa. The actuated brake-yaw moments can be seen in Figure 9(d). Figures 9(e) and 9(f) show the actuated brake pressures, which prove the limitation of the brake-yaw moment.

In the third simulation example all of the rear brake circuits have leakage. This situation is compared to a fault-free case and an uncontrolled situation. Figure 10(a) shows the lateral errors of the vehicle in the three cases. The lateral error of the vehicle increases because of faults and the faulty controlled system tracks the trajectory more accurately than the uncontrolled vehicle. The steering wheel angle and the front wheel steering angle are illustrated in Figures 10(c) and (d), respectively. The fault of the brake-

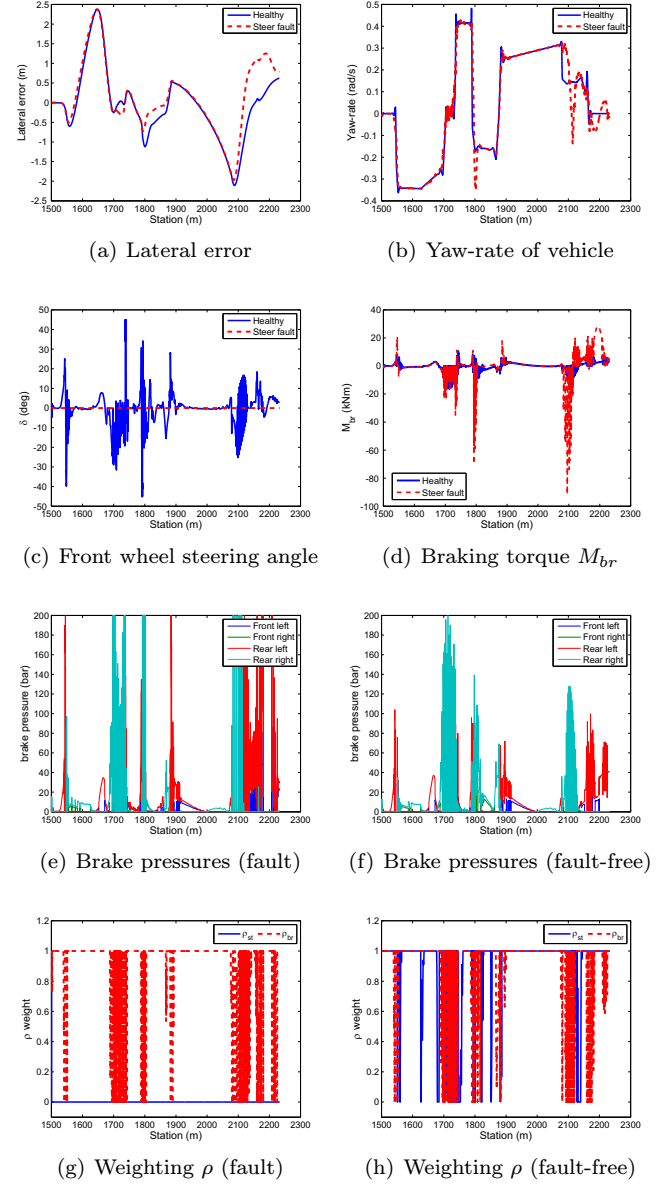

Fig. 8. Steering fault compared to the fault-free integrated control

yaw moment affects the increased actuation of the front wheel steering.

## 6. CONCLUSION

The paper has proposed the design of a supervisory integrated reconfigurable driver assistance system which is able to track road geometry. The actuators of the control system are the front-wheel steering and the brake yaw-moment. The paper extends the control design with an actuator selection procedure, which is built in the design of the supervisor of the system. The control design of actuators is based on the robust optimal LPV method, in which both performance specifications and model uncertainties are taken into consideration. The quadratic stability of the closed-loop LPV system, which contains the individually designed controllers, is guaranteed by a common Lyapunov function. A possible realization of the required control system has also been presented. The integrated system

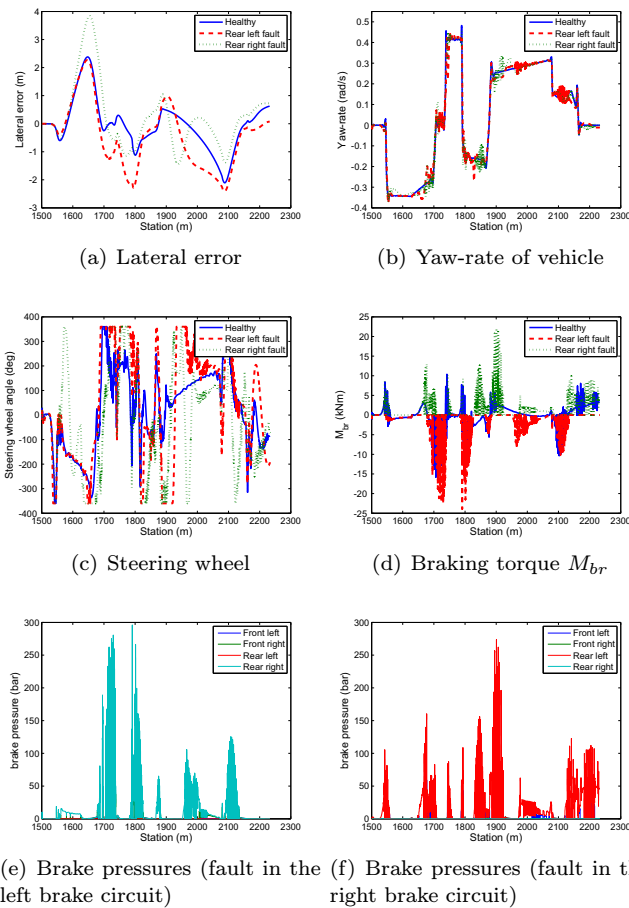

Fig. 9. Comparison of a fault in the left-hand-side brake circuit with a fault in the right-hand-side brake circuit

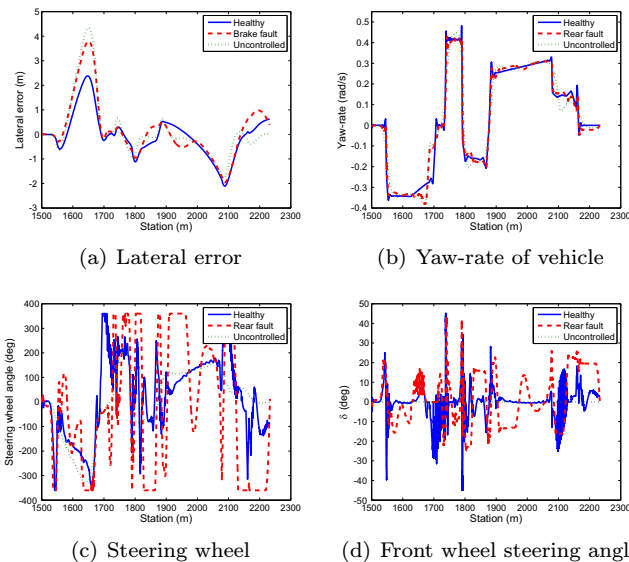

Fig. 10. Comparison of the faults in the rear brake circuits with the fault-free integrated control

makes it possible to achieve a reconfigurable and fault-tolerant system. The fault-tolerance of the controlled system is demonstrated through simulation examples. It can be established that the designed integrated supervisory control system tolerates steering and braking faults by

using the proposed weighting strategy and realizes the actuator reconfiguration effectively.

## REFERENCES

- Bokor, J. and Balas, G. (2004). Detection filter design for LPV systems - a geometric approach. *Automatica*, 40, 511–518.
- Bokor, J. and Balas, G. (2005). Linear parameter varying systems: A geometric theory and applications. *16th IFAC World Congress, Prague*.
- Boyd, S., Ghaoui, L.E., Feron, E., and Balakrishnan, V. (1997). *Linear Matrix Inequalities in System and Control Theory*. Society for Industrial and Applied Mathematics, Philadelphia.
- Claeys, X., de Wit, C.C., and Bechart, H. (1999). Modeling and control of steering actuator for heavy duty vehicle. *European Control Conference ECC'99*.
- Doumiati, M., Sename, O., Martinez, J., Dugard, L., and Poussot-Vassal, C. (2010). Gain-scheduled LPV/Hinf controller based on direct yaw moment and active steering for vehicle handling improvements. *49th Conf. on Decision and Control*, 6427 – 6432.
- Edelmayer, A., Bokor, J., Szigeti, F., and Keviczky, L. (1997). Robust detection filter design in the presence of time-varying system perturbations. *Automatica*, 33(3), 471–475.
- Gáspár, P., Szabó, Z., and Bokor, J. (2012). Lpv design of fault-tolerant control for road vehicles. *International Journal of Applied Mathematics and Computer Science*, 22(1), 173–182.
- Gáspár, P., Szabó, Z., Bokor, J., Sename, O., and Dugard, L. (2010). Design of a reconfigurable global chassis control. *FISITA Congress, Budapest*.
- Jianyong, W., Houjun, T., Shaoyuan, L., and Wan, F. (2007). Improvement of vehicle handling and stability by integrated control of four wheel steering and direct yaw moment. *Proc. 26th Chinese Control Conference, Zhangjiajie*.
- Ono, E., Hattori, Y., Muragishi, Y., and Koibuchi, K. (2006). Vehicle dynamics integrated control for four-wheel-distributed steering and four-wheel-distributed traction/braking systems. *Vehicle System Dynamics*, 44:2.
- Pacejka, H.B. (2004). *Tyre and vehicle dynamics*. Elsevier Butterworth-Heinemann, Oxford.
- Packard, A. and Balas, G. (1997). Theory and application of linear parameter varying control techniques. *American Control Conference, Workshop 1, Albuquerque, New Mexico*.
- Poussot-Vassal, C., Sename, O., Dugard, L., Gáspár, P., Szabó, Z., and Bokor, J. (2011). Attitude and handling improvements through gain-scheduled suspensions and brakes control. *Control Engineering Practice*, 19(3), 252–263.
- Rajamani, R., Tan, H., Law, B., and Zhang, W. (2000). Demonstration of integrated longitudinal and lateral control for the operation of automated vehicles in platoons. *Trans. on Control Systems Technology*, 8, 695–708.
- Scherer, C. and Weiland, S. (2000). *Lecture Notes DISC Course on Linear Matrix Inequalities in Control*. Delft University of Technology, Delft, Netherlands.
- Trachtler, A. (2004). Integrated vehicle dynamics control using active brake, steering and suspension systems. *International Journal of Vehicle Design*, 36, 1–12.
- Wu, F., Yang, X.H., Packard, A., and Becker, G. (1996). Induced  $l^2$ -norm control for LPV systems with bounded parameter variation rates. *International Journal of Nonlinear and Robust Control*, 6, 983–998.
- Yu, F., Li, D., and Crolla, D. (2008). Integrated vehicle dynamics control: State-of-the art review. *IEEE Vehicle Power and Propulsion Conference, Harbin, China*.
- Zhang, S., Zhang, T., and Zhou, S. (2009). Vehicle stability control strategy based on active torque distribution and differential braking. *Int. Conference on Measuring Technology and Mechatronics Automation*.
- Zin, A., Sename, O., Gáspár, P., Szabó, Z., Dugard, L., and Bokor, J. (2008). An LPV/Hinf active suspension control for global chassis technology: Design and performance analysis. *Vehicle System Dynamics*, 46, 889–912.