



HAL
open science

AIRCRAFT CONTROL USING FLATNESS

Philippe Martin

► **To cite this version:**

Philippe Martin. AIRCRAFT CONTROL USING FLATNESS. IMACS/IEEE-SMC Multiconference CESA'96 - Symposium on Control, Optimization and Supervision, 1996, Lille, France. pp.194–199. hal-00935110

HAL Id: hal-00935110

<https://hal.science/hal-00935110>

Submitted on 23 Jan 2014

HAL is a multi-disciplinary open access archive for the deposit and dissemination of scientific research documents, whether they are published or not. The documents may come from teaching and research institutions in France or abroad, or from public or private research centers.

L'archive ouverte pluridisciplinaire **HAL**, est destinée au dépôt et à la diffusion de documents scientifiques de niveau recherche, publiés ou non, émanant des établissements d'enseignement et de recherche français ou étrangers, des laboratoires publics ou privés.

AIRCRAFT CONTROL USING FLATNESS

Philippe Martin *

* *Centre Automatique et Systèmes, École des Mines de Paris*
 35, rue Saint-Honoré, 77305 Fontainebleau Cedex, France
 martin@cas.ensmp.fr

Abstract: A control law for an aircraft is presented. It is valid on the whole flight envelope and able to track any prescribed reference trajectory. The design relies on the flatness property of a simplified model globally approximating the real aircraft and the use of time scales.

Keywords: Aircraft control, nonlinear control, flatness, perturbations.

1. INTRODUCTION

Automatic flight control systems (AFCSs) rely more often than not on the principle “one function, one controller”: loosely speaking, for each flight control (pitch attitude control, wing leveler, sideslip suppressor,...) a specific control law is designed, using a partial model of the aircraft. All these flight functions can be seen as special cases of the problem of generating and then tracking a reference trajectory of the “complete” (nonlinear) model describing the aircraft (for these simple functions the references trajectories correspond to steady state conditions). This appears even more clearly for sophisticated flight functions required of modern AFCSs: landing, very low altitude flight (to avoid radar detection), target tracking, etc; the reference trajectories can be here arbitrary. The traditional approach in AFCSs’ design usually ignores this nonlinear generation/tracking point of view, and prefers to rely on linear methods (and models); very loosely speaking, it has to restrict to reference trajectories, around which there is a (nearly) time-invariant tangent linear approximation (in other words pieces of straight lines, circles and helices with slowly varying altitude). Since it cannot easily handle more general trajectories, it often leads to a very complicated AFCS structure lacking theoretical ground, especially when it comes to sophisticated flight functions, and has to rely heavily on simulations.

We propose here a different approach, based on the remark that the nonlinear model of the aircraft is *flat* [2]: all the variables are completely determined as soon as the time evolution of the center of mass and sideslip angle are fixed. These four scalar quantities are “differentially independent” and correspond (in a nonlinear and coupled way) to the four controls (throttle, ailerons, rudder, elevators). Thanks to this property, it is possible on the one hand to easily translate most of the flight objectives into a reference trajectory, and on the other hand to design a controller –valid on the whole flight envelope– able to track any reference trajectory. By lack of space, we will concentrate in the sequel only on the controller, without insisting on the trajectory generator.

This work is an abridged version of [4, chapter IV] and stems from a collaboration with Sextant Avionique under DRET funding.

2. MODEL OF THE AIRCRAFT

A flying aircraft is a very complicated system. It is nevertheless possible to write down a rather simple and, as far as control is concerned, accurate model based on the following standard assumptions. The complete derivation can be found in [4, chapter IV]; we have partly followed [8,9] (see also [6,1,5]):

- The aircraft is a six degree of freedom rigid body with a plane of symmetry.
- Constant mass and inertia.
- Quasisteady aerodynamic flow fields
- Atmosphere obeys the “standard” model
- Earth’s curvature is neglected.

The more questionable assumption is probably to consider the aircraft as a rigid body. The aeroelastic effects may in some cases be very important, and have to be taken into account from the beginning in the control law, which makes the design much more difficult.

By applying Newton’s Second Law, the equations of motion can be established, resulting in 12 first-order differential equations linking the 12 following state variables: x, y, z , components of the center of mass in the Earth axes; V, α, β , velocity, angle of attack and sideslip angle; χ, γ, μ , orientation of the wind axes; p, q, r , components of the angular velocity in the body axes. The aircraft is “conventionally” actuated by four independent controls: the thrust F and the positions $(\delta_l, \delta_m, \delta_n)$ of the deflection surfaces.

Projected in the wind axes, the sum of the external forces (aerodynamic, gravitational and propulsive (thrust)) reads

$$\begin{pmatrix} X \\ Y \\ Z \end{pmatrix} := \underbrace{\frac{1}{2}\rho S V^2 \begin{pmatrix} -C_x \\ C_y \\ -C_z \end{pmatrix}}_{\text{Aerodynamic}} + \underbrace{mg \begin{pmatrix} -\sin \gamma \\ \cos \gamma \sin \mu \\ \cos \gamma \cos \mu \end{pmatrix}}_{\text{Gravitational}} + \underbrace{F \begin{pmatrix} \cos(\alpha + \varepsilon) \cos \beta \\ \cos(\alpha + \varepsilon) \sin \beta \\ -\sin(\alpha + \varepsilon) \end{pmatrix}}_{\text{Propulsive}}.$$

The dimensionless aerodynamic coefficients C_x, C_y, C_z are experimentally determined in a wind tunnel; ρ is the air density. S (reference surface) and ε (orientation of the propulsor) are constant. Similarly, the sum of the moments of the external forces about the center of mass read in the body axes

$$\begin{pmatrix} L \\ M \\ N \end{pmatrix} := \frac{1}{2}\rho S V^2 \begin{pmatrix} aC_l \\ bC_m \\ cC_n \end{pmatrix} + Fc \begin{pmatrix} 0 \\ 1 \\ 0 \end{pmatrix},$$

where C_l, C_m, C_n are dimensionless aerodynamic coefficients and a, b, c are constant (reference lengths). The gravitational forces do of course not contribute.

It is commonly assumed that $C_x, C_y, C_z, C_l, C_m, C_n$ depend on the translational velocity (i.e., V, α, β) and acceleration ($\dot{V}, \dot{\alpha}, \dot{\beta}$), angular velocity (p, q, r), position of the deflection surfaces $(\delta_l, \delta_m, \delta_n)$, and Mach number (i.e., V/c , where c is the velocity of sound in air). These coefficients consist of arrays of data obtained from experiments in a wind tunnel (see [8] for an example). They vary a lot with the Mach num-

ber in transsonic flight. A crucial remark for the design of our control law will be that, for nearly every aircraft, C_x, C_y, C_z depend only “slightly” on $\dot{V}, \dot{\alpha}, \dot{\beta}, p, q, r, \delta_l, \delta_m, \delta_n$. In the same way, though it is not as important, C_l, C_m, C_n depend only “slightly” on $\dot{V}, \dot{\alpha}, \dot{\beta}, p, q, r$ (of course they “strongly” depend on $\delta_l, \delta_m, \delta_n$).

The aerodynamic forces and moments depend on the air density ρ and, through the Mach number, on the sound velocity c . The “standard atmosphere model” [9] allows to express these quantities as functions depending only on the altitude z . It relies on some classical laws of thermodynamics and on an empiric formula expressing the absolute temperature in function of the altitude; notice these quantities are sensitive to altitude (for instance ρ is divided by three between sea level and 11000m). The aerodynamic forces and moments can therefore be written only in terms of the state variables. Since ρ varies a lot with altitude, so do the aerodynamic forces.

Projected in the wind axes (translational equations) and body axes (rotational equations), Newton’s Second Law reads

$$\dot{x} = V \cos \chi \cos \gamma \quad (1)$$

$$\dot{y} = V \sin \chi \cos \gamma \quad (2)$$

$$\dot{z} = -V \sin \gamma \quad (3)$$

$$\dot{V} = \frac{X}{m} \quad (4)$$

$$\dot{\alpha} = -p \cos \alpha \tan \beta + q - r \sin \alpha \tan \beta + \frac{Z}{mV \cos \beta} \quad (5)$$

$$\dot{\beta} = p \sin \alpha - r \cos \alpha + \frac{Y}{mV} \quad (6)$$

$$\dot{\gamma} = -\frac{Y \sin \mu + Z \cos \mu}{mV} \quad (7)$$

$$\dot{\chi} = \frac{Y \cos \mu - Z \sin \mu}{mV \cos \gamma} \quad (8)$$

$$\dot{\mu} = p \frac{\cos \alpha}{\cos \beta} + r \frac{\sin \alpha}{\cos \beta} + \frac{Y \cos \mu \tan \gamma}{mV} - \frac{Z(\sin \mu \tan \gamma + \tan \beta)}{mV} \quad (9)$$

$$I \begin{pmatrix} \dot{p} \\ \dot{q} \\ \dot{r} \end{pmatrix} = \begin{pmatrix} L \\ M \\ N \end{pmatrix} - \begin{pmatrix} p \\ q \\ r \end{pmatrix} \wedge I \begin{pmatrix} p \\ q \\ r \end{pmatrix} \quad (10)$$

where I is the aircraft matrix of inertia and X, Y, Z, L, M, N are the sum of forces and moments previously described.

On a modern aircraft, the deflection surfaces are actuated through electric or hydraulic servoactuators. These servoactuators are commonly modelled only as “fast” transfer functions. We will use a crude first-order model, representing the “slow” servoactuators dynamics:

$$\begin{pmatrix} \dot{\delta}_l \\ \dot{\delta}_m \\ \dot{\delta}_n \end{pmatrix} = A \begin{pmatrix} \tilde{\delta}_l \\ \tilde{\delta}_m \\ \tilde{\delta}_n \end{pmatrix}, \quad (11)$$

where $\tilde{\delta}_l, \tilde{\delta}_m, \tilde{\delta}_n$ are the actual controls, and A is a stable matrix.

For the sake of simplicity, we will not consider here the (rather complicated) dynamic relation between the thrust F and the throttle, which is the actual control. Let us only mention our control scheme can nevertheless take it into account.

3. THE IDEAL AIRCRAFT IS FLAT

An essential consequence from the previous section is that the aerodynamic forces X, Y, Z depend on z, V, α, β, F but only “slightly” on $\dot{V}, \dot{\alpha}, \dot{\beta}, p, q, r, \delta_l, \delta_m, \delta_n$. Similarly, the moments L, M, N depend “slightly” on $\dot{V}, \dot{\alpha}, \dot{\beta}, p, q, r$. By neglecting these small dependencies, we obtain an “ideal” aircraft, that we will use to design the control law. The idea is that the ideal aircraft is flat, hence easy to control, whereas the real aircraft isn’t. We thus consider the “true” system

$$\Sigma_\varepsilon : \quad \dot{x} = f(x, u) + \varepsilon g(x, u),$$

with ε a “small” parameter, as a perturbation of an “ideal” system

$$\Sigma_0 : \quad \dot{x} = f(x, u).$$

If ε is small enough, a standard argument of regular perturbations theory [7] proves that a control stabilizing Σ_0 around a trajectory will also stabilize Σ around a nearby trajectory (with an error of order ε). Notice that the approximation made here is structural and valid on the whole state space, contrary to a linear tangent approximation, valid only locally.

We now prove without calculations, only by using the structure of the equations, that the ideal aircraft is flat, with (x, y, z, β) as a flat output (see [2,4] for a more formal approach of flat systems). *This simply means that any trajectory of the ideal aircraft, i.e. any map*

$$t \mapsto (x_r(t), y_r(t), z_r(t), V_r(t), \alpha_r(t), \beta_r(t), \gamma_r(t), \chi_r(t), \\ \mu_r(t), p_r(t), q_r(t), r_r(t), \delta_{lr}(t), \delta_{mr}(t), \delta_{lr}(t), \\ \tilde{\delta}_{lr}(t), \tilde{\delta}_{mr}(t), \tilde{\delta}_{lr}(t))$$

satisfying the model equations, is completely determined by $(x_r(t), y_r(t), z_r(t), \beta_r(t))$. This can be seen as an explicit parametrization of all the trajectories of the system by differentially independent functions. Indeed, by inverting the equations (1)–(3), we can obviously write

$$(V, \gamma, \chi) = a(\dot{x}, \dot{y}, \dot{z}). \quad (12)$$

Inverting the equations (4), (7) et (8), *and because the forces X, Y, Z do not depend on $p, q, r, \delta_l, \delta_m, \delta_n$, we can then write*

$$\begin{aligned} (\alpha, \mu, F) &= b(z, V, \gamma, \chi, \dot{V}, \dot{\gamma}, \dot{\chi}, \beta) \\ &= \tilde{b}(\dot{x}, \dot{x}, \dot{y}, \dot{y}, z, \dot{z}, \dot{z}, \beta), \end{aligned}$$

where (12) and its derivative have been used to express V, γ, χ and their derivatives in function of $\dot{x}, \dot{y}, \dot{z}, \ddot{x}, \ddot{y}, \ddot{z}$. Similarly, using (5),(6) and (9), we can write

$$\begin{aligned} (p, q, r) &= c(z, V, \gamma, \chi, \mu, \alpha, \beta, F, \dot{\alpha}, \dot{\beta}, \dot{\mu}) \\ &= \tilde{c}(\dot{x}, \ddot{x}, x^{(3)}, \dot{y}, \ddot{y}, y^{(3)}, z, \dot{z}, \ddot{z}, z^{(3)}, \beta, \dot{\beta}). \end{aligned}$$

Going on with this process, it easily follows from (10)

$$(\delta_l, \delta_m, \delta_n) = d(\dot{x}, \dots, x^{(4)}, \dot{y}, \dots, y^{(4)}, z, \dots, z^{(4)}, \beta, \dot{\beta}, \ddot{\beta}),$$

and eventually from (11)

$$(\tilde{\delta}_l, \tilde{\delta}_m, \tilde{\delta}_n) = d(\dot{x}, \dots, x^{(5)}, \dot{y}, \dots, y^{(5)}, z, \dots, z^{(5)}, \beta, \dots, \beta^{(3)}).$$

At this stage, all the variables entering the model have been expressed in terms of the flat output and its derivatives. We insist that this means in particular that the orientation and angle of attack of the aircraft are completely determined by the evolution of the center of mass and sideslip angle.

A consequence of this remarkable flatness property is that the ideal aircraft is easy to control, using for instance a linearizing dynamic feedback.

4. CONTROL SCHEME

4.1 Control design using time scales

For nearly any aircraft, the numerical values of the model parameter imply the existence of time scales: the system (1)–(11) can be rewritten as

$$\dot{\Xi} = f(\Xi, \Omega, F) \quad (13)$$

$$\varepsilon \dot{\Omega} = C(\Xi, \Omega, F) + D(\Xi, \Omega, F)\delta \quad (14)$$

$$\varepsilon^2 \dot{\delta} = A\delta + \tilde{\delta}, \quad (15)$$

where ε is a “small” parameter, $\Xi := (x, y, z, V, \alpha, \beta, \gamma, \chi, \mu)$, $\Omega := (p, q, r)$, $\delta := (\delta_l, \delta_m, \delta_n)$ and $\tilde{\delta} := (\tilde{\delta}_l, \tilde{\delta}_m, \tilde{\delta}_n)$. The “slow” part (13) corresponds to equations (1)-(9), the “fast” part (14) to (10) and the “very fast” part (15) to (11). The physical interpretation is that the servactuators react fast compared to the aircraft dynamics, and that the deflection surfaces rapidly affect the angular velocity.

The existence of time scales allows to simplify the controller design by using singular perturbations theory [7,3]. The idea is to split the controller into three independent pieces and in fact to reduce the problem to the control of the slow part. Indeed, assume we know a feedback law $\Omega := \Omega^*(t, \Xi)$, $F = F^*(t, \Xi)$ which does the job for the slow part (13). If Ω could be directly acted on, the problem would be solved;

instead, the fast part is used to drive Ω to Ω^* : if δ could be directly acted on, this could be done by the feedback

$$\delta^* := D^{-1} (\Lambda(\Omega - \Omega^*) - C),$$

where Λ is a stable matrix (the closed-loop fast part would then become $\epsilon \dot{\Omega} = \Lambda(\Omega - \Omega^*)$). For that, it suffices to drive δ to δ^* by the feedback

$$\tilde{\delta} := -A\delta^* = -AD^{-1} (\Lambda(\Omega - \Omega^*) - C).$$

This scheme allows to control the full system; indeed, since the very fast part is stable, $\delta \approx -A^{-1}\tilde{\delta} = \delta^*$ after a very short time; this implies that the fast part is stable, hence that $\Omega \approx \Omega^*$ after a short time. After this short time, the slow part react as if it were directly actuated by Ω^* . This heuristic explanation can be made more formal by a standard argument of singular perturbations theory [7,3]. Notice all this remains valid even if A and Λ are not constant (and even if the fast and very fast parts are not linear); in particular, it can be useful to have Λ depend on the altitude z and velocity V to take into account the variation in efficiency with respect to these variables of the deflection surfaces. The only thing which matters is to ensure that Ω^* and Λ are not too large (i.e., order 1 with respect to ϵ) in order not to “mix” the time scales.

The control design by time scales leads to a not only simpler and more modular control law, but also more robust. Indeed the existence of time scales means the system is numerically ill-conditioned. A control law ignoring these aspects tends to be also ill-conditioned, hence more difficult to implement and more sensitive to modeling errors.

4.2 Control of the slow part

As a direct consequence of flatness, the system can be linearized by (dynamic) feedback and coordinate change. Putting aside theoretical considerations (see [2,4] for details), the linearizing feedback can here be immediately recovered from the flat output (x, y, z, β) : indeed, differentiating (x, y, z) three times and β once, we get

$$\begin{pmatrix} x^{(3)} \\ y^{(3)} \\ z^{(3)} \\ \dot{\beta} \end{pmatrix} = \mathcal{A}(\Xi, F) + \mathcal{B}(\Xi, F) \cdot \begin{pmatrix} \Omega \\ \dot{F} \end{pmatrix},$$

where \mathcal{B} is an invertible matrix. This is just a rephrasement of the relations obtained in section 3. In other words, we have three chains of nonlinear integrateurs of length 3 and one of length 1 involving the 10 variables (Ξ, F) . In other words, the mapping

$$(\Xi, F) \mapsto (x, y, z, \dot{x}, \dot{y}, \dot{z}, \ddot{x}, \ddot{y}, \ddot{z}, \beta)$$

can be seen as a coordinate change. In these new coordinates, the system acted on by the (dynamic) feedback

$$\begin{aligned} \dot{F} &= \tilde{F} \\ \begin{pmatrix} \Omega \\ \dot{F} \end{pmatrix} &= \mathcal{B}^{-1}(\Xi, F) \cdot (v - \mathcal{A}(\Xi, F)), \end{aligned}$$

is clearly linear. To track a reference trajectory $(\Xi_r(t); \Omega_r(t), F_r(t))$ which is, as shown in the previous section, completely determined by $(x_r(t), y_r(t), z_r(t), \beta_r(t))$, it suffices to place the poles of the feedback linearized system by

$$v = \begin{pmatrix} x_r^{(3)} \\ y_r^{(3)} \\ z_r^{(3)} \\ \dot{\beta}_r(t) \end{pmatrix} + K \begin{pmatrix} x - x_r(t) \\ y - y_r(t) \\ z - z_r(t) \\ \dot{x} - \dot{x}_r(t) \\ \dot{y} - \dot{y}_r(t) \\ \dot{z} - \dot{z}_r(t) \\ \ddot{x} - \ddot{x}_r(t) \\ \ddot{y} - \ddot{y}_r(t) \\ \ddot{z} - \ddot{z}_r(t) \\ \beta - \beta_r(t) \end{pmatrix}.$$

It is possible, though rather tedious, to put the above linearizing feedback into a form quite appealing from a physical point of view, which moreover shows that it is defined for all normal flight conditions; we refer the reader to [4] for the details. Notice the feedback uses the first partial derivatives of the aerodynamic coefficients C_x, C_y, C_z . As they represent the major aerodynamic effects, they are known with a good precision and can be numerically differentiated (though the result might be not so good in transsonic flight, where these coefficients vary a lot). Notice also that is in theory possible to feedback linearize the full ideal aircraft without relying on a time-scale decomposition. This is nevertheless not very sensible to implement this in practice, since it would result in a very complicated control law, moreover very sensitive to model errors (in particular, the third partial derivatives of the aerodynamic coefficients would be needed). The time-scale approach leads to a much better-behaved controller.

5. SIMULATIONS: NONPLANAR DIVE

We present simulations for the *F4* fighter aircraft; the complete aerodynamic data can be found in [8]. These arrays of coefficients have been interpolated by cubic splines; the main coefficients, the partial differentials of which are used in the controller, have then been numerically differentiated and filtered (as mentioned before, these numerical differentiations give rather accurate results, except maybe in transsonic flight, where the coefficients vary rapidly). The simulation includes the full aircraft dynamics with all the aerodynamic effects and the servoactuators dynamics; the controller and trajectory generator are designed from the reduced ideal model. The goal is to track for one minute the reference trajectory (“nonplanar dive”, fig. 5) determined by

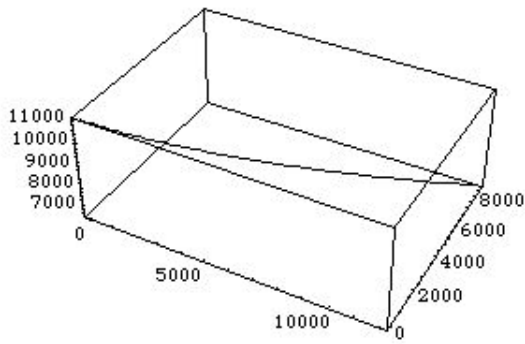

Fig. 1. Nonplanar dive

$$\begin{aligned}
 x_{ref}(t) &= 200t \\
 y_{ref}(t) &= 2.375t^2 \\
 z_{ref}(t) &= -11000 + 1.2t^2 \\
 \beta_{ref}(t) &= 0.
 \end{aligned}$$

At $t = 0$, the aircraft is flying level at $200m/s$ along the x -axis at the altitude of $11000m$: $x_0 = 0, y_0 = 0, z_0 = -11000, \beta_0 = 0, \dot{x}_0 = 200, \dot{y}_0 = 0, \dot{z}_0 = 0, \ddot{x}_0 = 0, \ddot{y}_0 = 0, \ddot{z}_0 = 0$ (MKSA units). This trajectory is not as simple as it may look for an AFCS: it is not a planar curve (hence strong couplings), altitude and velocity vary a lot (more than $4300m$ altitude loss, velocity from $200m/s$ to $380m/s$, it breaks the sound barrier (Mach number from 0.65 to Mach 1.2). The variation of atmospheric and aerodynamic parameters along the trajectory is therefore very large.

Figure 2 shows the norm of the error in position (i.e., the distance between the reference and actual position), figure 3 the error in cartesian velocity and figure 4 the error in cartesian acceleration; figure 5 shows the sideslip angle. The results are very good. The position error is maximum (about $13m$) when breaking the sound barrier (see the Mach number on figure 6), that is, when the aerodynamic coefficients are not very accurately known; most of this error could be removed by adding some integral terms in the linear feedback loop. Notice the initial bumps due to a mismatch in initial conditions (there is a discontinuity in curvature between level flight and the dive).

Figure 7 shows the angle of attack.

Figures 8–10 illustrate the “complexity” of the trajectory for an AFCS: the orientation angles vary a lot and in a coupled way, much beyond the validity domain of a tangent linear approximation.

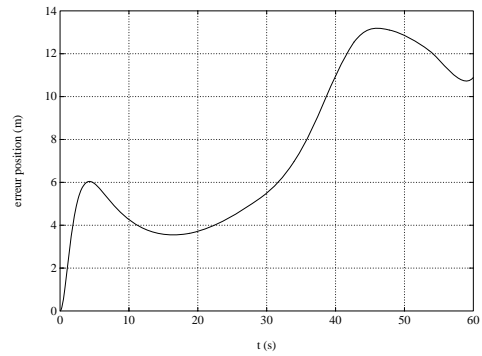

Fig. 2. Position error (m)

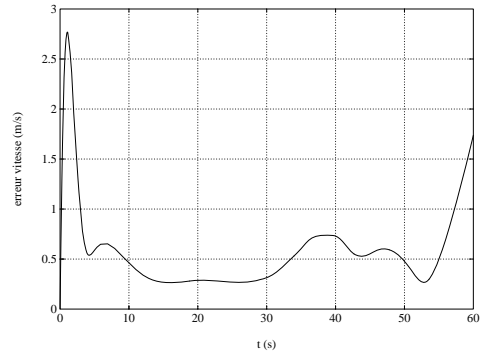

Fig. 3. Velocity error (m/s)

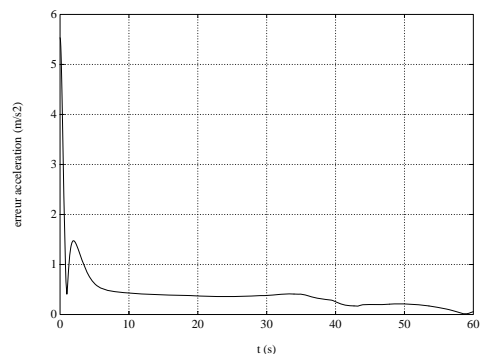

Fig. 4. Acceleration error (m/s^2)

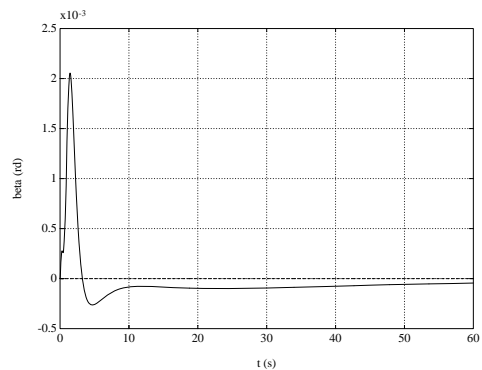

Fig. 5. sideslip angle β (rad)

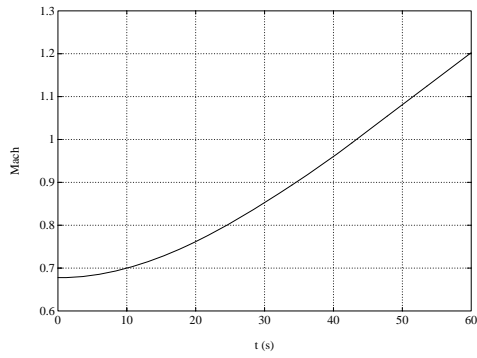

Fig. 6. Mach number

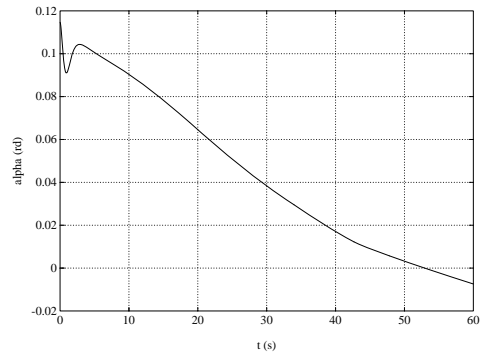

Fig. 7. Angle of attack α (rad)

6. REFERENCES

- [1] B. Etkin. *Dynamics of flight – Stability and control*. John Wiley, 1982. Second edition.
- [2] M. Fliess, J. Lévine, Ph. Martin, and P. Rouchon. Flatness and defect of nonlinear systems: introductory theory and applications. *Int. J. of Control*, 61(6):1327–1361, 1995.
- [3] P. Kokotović, H.K. Khalil, and J. O’Reilly. *Singular perturbations methods in control: analysis and design*. Academic Press, 1986.
- [4] Ph. Martin. *Contribution à l’étude des Systèmes Différentiellement Plats*. PhD thesis, Ecole des Mines de Paris, France, 1992.
- [5] D. McLean. *Automatic flight control systems*. Prentice Hall, 1990.
- [6] D.T. McRuer, I.L. Ashkenas, and D.C. Graham. *Aircraft dynamics and automatic control*. Princeton University Press, 1973.
- [7] A.N. Tikhonov, A.B. Vasil’eva, and A.G. Sveshnikov. *Differential equations*. Springer-Verlag, 1985.
- [8] M. Vukobratović and R. Stojić. *Modern Aircraft Flight Control*. Springer-Verlag, 1988.
- [9] J.C. Wanner. Dynamique du vol et pilotage des avions. Technical report, Ecole Nationale Supérieure de l’Aéronautique et de l’Espace, Toulouse, France, 1984.

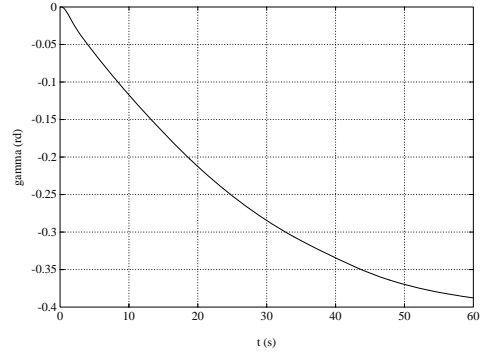

Fig. 8. γ (rad)

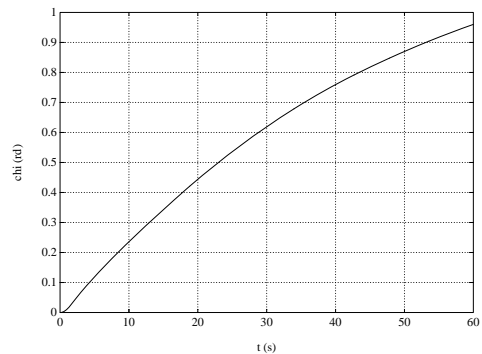

Fig. 9. χ (rad)

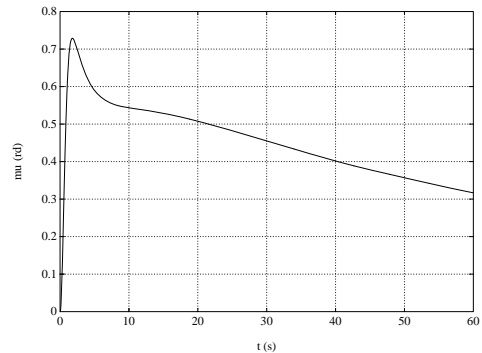

Fig. 10. μ (rad)