



HAL
open science

Generic measures for geodesic flows on nonpositively curved manifolds

Yves Coudène, Barbara Schapira

► **To cite this version:**

Yves Coudène, Barbara Schapira. Generic measures for geodesic flows on nonpositively curved manifolds. Journal de l'École polytechnique - Mathématiques, 2014, 1, pp.387-408. 10.5802/jep.14 . hal-00933903

HAL Id: hal-00933903

<https://hal.science/hal-00933903>

Submitted on 21 Jan 2014

HAL is a multi-disciplinary open access archive for the deposit and dissemination of scientific research documents, whether they are published or not. The documents may come from teaching and research institutions in France or abroad, or from public or private research centers.

L'archive ouverte pluridisciplinaire **HAL**, est destinée au dépôt et à la diffusion de documents scientifiques de niveau recherche, publiés ou non, émanant des établissements d'enseignement et de recherche français ou étrangers, des laboratoires publics ou privés.

Generic measures for geodesic flows on nonpositively curved manifolds

Yves Coudène, Barbara Schapira

21 January 2014

*Laboratoire de mathématiques, UBO, 6 avenue le Gorgeu, 29238 Brest, France
LAMFA, UMR CNRS 7352, Université Picardie Jules Verne, 33 rue St Leu,
80000 Amiens, France*

Abstract

We study the generic invariant probability measures for the geodesic flow on connected complete nonpositively curved manifolds. Under a mild technical assumption, we prove that ergodicity is a generic property in the set of probability measures defined on the unit tangent bundle of the manifold and supported by trajectories not bounding a flat strip. This is done by showing that Dirac measures on periodic orbits are dense in that set.

In the case of a compact surface, we get the following sharp result: ergodicity is a generic property in the space of all invariant measures defined on the unit tangent bundle of the surface if and only if there are no flat strips in the universal cover of the surface.

Finally, we show under suitable assumptions that generically, the invariant probability measures have zero entropy and are not strongly mixing.¹

1 Introduction

Ergodicity is a generic property in the space of probability measures invariant by a topologically mixing Anosov flow on a compact manifold. This result, proven by K. Sigmund in the seventies [Si72], implies that on a compact connected negatively curved manifold, the set of ergodic measures is a dense G_δ subset of the set of all probability measures invariant by the geodesic flow. The proof of K. Sigmund's result is based on the specification property. This property relies on the uniform hyperbolicity of the system and on the compactness of the ambient space.

In [CS10], we showed that ergodicity is a generic property of hyperbolic systems without relying on the specification property. As a result, we were able to prove that the set of ergodic probability measures invariant by the geodesic flow, on a negatively curved manifold, is a dense G_δ set, without any compactness assumptions or pinching assumptions on the sectional curvature of the manifold.

A corollary of our result is the existence of ergodic invariant probability measures of full support for the geodesic flow on any complete negatively curved manifold, as soon as the flow is transitive. Surprisingly, we succeeded in extending this corollary to the nonpositively curved setting. However, the question of genericity in nonpositive curvature appears to be much more difficult, even for surfaces. In [CS11], we gave examples of compact nonpositively curved surfaces with negative

¹37B10, 37D40, 34C28

Euler characteristic for which ergodicity is not a generic property in the space of probability measures invariant by the geodesic flow.

The first goal of the article is to obtain genericity results in the non positively curved setting. From now on, all manifolds are assumed to be *connected, complete* Riemannian manifolds. Recall that a *flat strip* in the universal cover of the manifold is a totally geodesic subspace isometric to the space $[0, r] \times \mathbf{R}$, for some $r > 0$, endowed with its standard euclidean structure. We first show that if there are no flat strip, genericity holds.

Theorem 1.1 *Let M be a nonpositively curved manifold, such that its universal cover has no flat strips. Assume that the geodesic flow has at least three periodic orbit on the unit tangent bundle T^1M of M . Then the set of ergodic probability measures on T^1M is a dense G_δ -subset of the set of all probability measures invariant by the flow.*

This theorem is a particular case of theorem 1.3 below. In the two-dimensional compact case, we get the following sharp result.

Theorem 1.2 *Let M be a nonpositively curved compact orientable surface, with negative Euler characteristic. Then ergodicity is a generic property in the set of all invariant probability measures on T^1M if and only if there are no flat strips on the universal cover of M .*

In the higher dimensional case, the situation is more complicated. Under some technical assumption, we prove that genericity holds in restriction to the set of nonwandering vectors whose lifts do not bound a flat strip.

Theorem 1.3 *Let M be a connected, complete, nonpositively curved manifold, and T^1M its unit tangent bundle. Denote by $\Omega \subset T^1M$ the nonwandering set of the geodesic flow, and $\Omega_{NF} \subset \Omega$ the set of nonwandering vectors that do not bound a flat strip. Assume that Ω_{NF} is open in Ω , and contains at least three different periodic orbits of the geodesic flow.*

Then the set of ergodic probability measures invariant by the geodesic flow and with full support in Ω_{NF} is a G_δ -dense subset of the set of invariant probability measures on Ω_{NF} .

The assumption that Ω_{NF} is open in Ω is satisfied in many examples. For instance, it is true as soon as the number of flat strips on the manifold is finite. The set of periodic orbits of the geodesic flow is in 1 – 1-correspondence with the set of oriented closed geodesics on the manifold. Thus, the assumption that Ω_{NF} contains at least three different periodic orbits means that there are at least two distinct nonoriented closed geodesics in the manifold that do not lie in the projection of a flat strip. This assumption rules out a few uninteresting examples, such as simply connected manifolds or cylinders, and corresponds to the classical assumption of nonelementarity in negative curvature.

Whether ergodicity is a generic property in the space of all invariant measures, in presence of flat strips of intermediate dimension, is still an open question. In section 4.4, we will see examples with periodic flat strips of maximal dimension where ergodicity is not generic.

The last part of the article is devoted to mixing and entropy. Inspired by results of [ABC10], we study the genericity of other dynamical properties of measures, as zero entropy or mixing. In particular, we prove that

Theorem 1.4 *Let M be a connected, complete, nonpositively curved manifold, such that Ω_{NF} contains at least three different periodic orbits of the geodesic flow and is open in the nonwandering set Ω .*

The set of invariant probability measures with zero entropy for the geodesic flow is generic in the set of invariant probability measures on Ω_{NF} . Moreover, the set of invariant probability measures on Ω_{NF} that are not strongly mixing is a generic set.

The assumptions in all our results include the case where M is a noncompact negatively curved manifold. In this situation, we have $\Omega = \Omega_{NF}$. Even in this case, theorem 1.4 is new. When M is a compact negatively curved manifold, it follows from [Si72], [Pa62]. Theorem 1.3 was proved in [CS10] in the negative curvature case.

Results above show that under our assumptions, ergodicity is generic, and strong mixing is not. We don't know under which condition weak-mixing is a generic property, except for compact negatively curved manifolds [Si72]. In contrast, topological mixing holds most of the time, and is equivalent to the non-arithmeticity of the length spectrum (see proposition 6.2).

In section 2, we recall basic facts on nonpositively curved manifolds and define interesting invariant sets for the geodesic flow. In section 3, we study the case of surfaces. The next section is devoted to the proof of theorem 1.3. At last, we prove theorem 1.4 in sections 5 and 6.

During this work, the authors benefited from the ANR grant ANR-JCJC-0108 Geode.

2 Invariant sets for the geodesic flow on nonpositively curved manifolds

Let M be a Riemannian manifold with nonpositive curvature, and let v be a vector belonging to the unit tangent bundle T^1M of M . The vector v is a *rank one vector*, if the only parallel Jacobi fields along the geodesic generated by v are proportional to the generator of the geodesic flow. A connected complete nonpositively curved manifold is a *rank one manifold* if its tangent bundle admits a rank one vector. In that case, the set of rank one vectors is an open subset of T^1M . Rank one vectors generating closed geodesics are precisely the hyperbolic periodic points of the geodesic flow. We refer to the survey of G. Knieper [K02] and the book of W. Ballmann [Ba95] for an overview of the properties of rank one manifolds.

Let $X \subset T^1M$ be an invariant set under the action of the geodesic flow $(g_t)_{t \in \mathbb{R}}$. Recall that the strong stable sets of the flow on X are defined by :

$$W^{ss}(v) := \{ w \in X \mid \lim_{t \rightarrow \infty} d(g_t(v), g_t(w)) = 0 \} ;$$

$$W_\varepsilon^{ss}(v) := \{ w \in W^{ss}(v) \mid d(g_t(v), g_t(w)) \leq \varepsilon \text{ for all } t \geq 0 \}.$$

One also defines the strong unstable sets W^{su} and W_ε^{su} of g_t ; these are the stable sets of g_{-t} .

Denote by $\Omega \subset T^1M$ the nonwandering set of the geodesic flow, that is the set of vectors $v \in T^1M$ such that for all neighbourhoods V of v , there is a sequence $t_n \rightarrow \infty$, with $g^{t_n}V \cap V \neq \emptyset$. Let us introduce several interesting invariant subsets of the nonwandering set Ω of the geodesic flow.

Definition 2.1 *Let $v \in T^1M$. We say that its strong stable (resp. unstable) manifold coincides with its strong stable (resp. unstable) horosphere if, for any*

lift $\tilde{v} \in T^1\tilde{M}$ of v , for all $\tilde{w} \in T^1\tilde{M}$, the existence of a constant $C > 0$ s.t. $d(g^t\tilde{v}, g^t\tilde{w}) \leq C$ for all $t \geq 0$ (resp. $t \leq 0$) implies that there exists $\tau \in \mathbb{R}$ such that $d(g^t g^\tau \tilde{v}, g^t \tilde{w}) \rightarrow 0$ when $t \rightarrow +\infty$ (resp. $t \rightarrow -\infty$).

Denote by $T_{hyp}^+ \subset T^1M$ (resp. T_{hyp}^-) the set of vectors whose stable (resp. unstable) manifold coincides with its stable (resp. unstable) horosphere, $T_{hyp} = T_{hyp}^+ \cap T_{hyp}^-$ and $\Omega_{hyp} = \Omega \cap T_{hyp}$.

The terminology comes from the fact that on Ω_{hyp} , a lot of properties of a hyperbolic flow still hold. However, periodic orbits in Ω_{hyp} are not necessarily hyperbolic in the sense that they can have zero Lyapounov exponents, for example higher rank periodic vectors.

Definition 2.2 *Let $v \in T^1M$. We say that v does not bound a flat strip if no lift $\tilde{v} \in T^1\tilde{M}$ of v determines a geodesic which bounds an infinite flat (euclidean) strip isometric to $[0, r] \times \mathbb{R}$, $r > 0$, on $T^1\tilde{M}$.*

The projection of a flat strip on the manifold M is called a periodic flat strip if it contains a periodic geodesic.

We say that v is not contained in a periodic flat strip if the geodesic determined by v on M does not stay in a periodic flat strip for all $t \in \mathbb{R}$.

In [CS10], we restricted the study of the dynamics to the set Ω_1 of nonwandering rank one vectors whose stable (resp. unstable) manifold coincides with the stable (resp. unstable) horosphere. If \mathcal{R}_1 denotes the set of rank one vectors, then $\Omega_1 = \Omega_{hyp} \cap \mathcal{R}_1$. The dynamics on Ω_1 is very close from the dynamics of the geodesic flow on a negatively curved manifold, but this set is not very natural, and too small in general. We improve below our previous results, by considering the following larger sets:

- the set Ω_{NF} of nonwandering vectors that do not bound a flat strip,
- the set Ω_{NFP} of nonwandering vectors that are not contained in a periodic flat strip,
- the set Ω_{hyp} of nonwandering vectors whose stable (resp. unstable) manifold coincides with the stable horosphere.

We have the inclusions

$$\Omega_1 \subset \Omega_{hyp} \subset \Omega_{NF} \subset \Omega_{NFP} \subset \Omega,$$

and they can be strict, except if M has negative curvature, in which case they all coincide. Indeed, a higher rank periodic vector is not in Ω_1 , but it can be in Ω_{hyp} when it does not bound a flat strip of positive width. A rank one vector whose geodesic is asymptotic to a flat cylinder is in Ω_{NF} but not in Ω_{hyp} .

Question 2.3 It would be interesting to understand when we have the equality $\Omega_{NF} = \Omega_{NFP}$. We will show that on compact rank one surfaces, if there is a flat strip, then there exists also a periodic flat strip. When the surface is a flat torus, we have of course $\Omega_{NF} = \Omega_{NFP} = \emptyset$.

It could also happen on some noncompact rank one manifolds that all vectors that bound a nonperiodic flat strip are wandering, so that $\Omega_{NF} = \Omega_{NFP}$.

Is it true on all rank-one surfaces, and/or all rank-one compact manifolds, that $\Omega_{NF} = \Omega_{NFP}$?

In the negative curvature case, it is standard to assume the fundamental group of M to be *nonelementary*. This means that there exists at least two (and therefore infinitely many) closed geodesics on M , and therefore at least four (and in fact

infinitely many) periodic orbits of the geodesic flow on T^1M (each closed geodesic lifts to T^1M into two periodic curves, one for each orientation). This allows to discard simply connected manifolds or hyperbolic cylinders, for which there is no interesting recurring dynamics.

In the nonpositively curved case, we must also get rid of flat euclidean cylinders, for which there are infinitely many periodic orbits, but no other recurrent trajectories. So we will assume that there exist at least three different periodic orbits in Ω_{NF} , that is, two distinct closed geodesics on M that do not bound a flat strip.

We will need another stronger assumption, on the flats of the manifold. *To avoid to deal with flat strips, we will work in restriction to Ω_{NF} , with the additional assumption that Ω_{NF} is open in Ω .* This is satisfied for example if M admits only finitely many flat strips. We will see that this assumption insures that the periodic orbits that do not bound a flat strip are dense in Ω_{hyp} and Ω_{NF} .

In the proof of theorems 1.3 and 1.4, the key step is the proposition below.

Proposition 2.4 *Let M be a connected, complete, nonpositively curved manifold, which admits at least three different periodic orbits that do not bound a flat strip. Assume that Ω_{NF} is open in Ω . Then the Dirac measures supported by the periodic orbits of the geodesic flow $(g^t)_{t \in \mathbb{R}}$ that are in Ω_{NF} , are dense in the set of all invariant probability measures defined on Ω_{NF} .*

3 The case of surfaces

In this section, M is a compact, connected, nonpositively curved orientable surface. We prove theorem 1.2.

If the surface admits a periodic flat strip, by our results in [CS11], we know that ergodicity cannot be generic. In particular, a periodic orbit in the middle of the flat strip is not in the closure of any ergodic invariant probability measure of full support.

If the surface admits no flat strip, then $\Omega = \Omega_{NF} = T^1M$, so that the result follows from theorem 1.3. It remains to show the following result.

Proposition 3.1 *Let M be a compact connected orientable nonpositively curved surface. If it admits a nonperiodic flat strip, then it admits also a periodic flat strip.*

The proof is inspired by unpublished work of Cao and Xavier. We proceed by contradiction. Assume that M is not a flat torus, but admits a nonperiodic flat strip.

There is an isometric embedding from $I \times \mathbb{R}_+$ to the universal cover \widetilde{M} . The interval I is necessarily bounded. Indeed, the manifold M is compact so it admits a relatively compact connected fundamental domain for the action of its fundamental group on \widetilde{M} . Such a fundamental domain cannot be completely included in a flat strip with infinite width.

Let $R_{max} \in \mathbb{R}_+$ be the supremum of the widths r of nonperiodic flat strips $[0, r] \times \mathbb{R}_+$ of \widetilde{M} . The above argument shows that R_{max} is finite.

Consider a vector $\tilde{v} \in T^1\widetilde{M}$ generating a trajectory $(g_t\tilde{v})_{t \geq 0}$ on $T^1\widetilde{M}$ that is tangent to a nonperiodic flat strip $[0, R] \times \mathbb{R}$, for some $\frac{9}{10}R_{max} \leq R \leq R_{max}$. Assume that R is maximal among the width of all flat strips containing \tilde{v} , and relocate \tilde{v} on the boundary of the strip. Assume also that the trajectory $(g_t\tilde{v})_{t \geq 0}$ bounds the right side $\{R\} \times \mathbb{R}_+$ of the flat strip and denote by v the image of \tilde{v} on T^1M .

Since M is compact, we can assume that there is a subsequence $g_{t_n}v$, with $t_n \rightarrow +\infty$, such that $g_{t_n}v$ converges to some vector v_∞ . This vector also lies on a flat strip of width at least R . Indeed, consider a lift \tilde{v}_∞ of v_∞ and isometries γ_n of \tilde{M} such that $\gamma_n(g_{t_n}\tilde{v})$ converges to \tilde{v}_∞ . Every point on the half-ball of radius R centered on the base point of \tilde{v}_∞ is accumulated by points on the euclidean half-balls centered on $\gamma_n(g_{t_n}\tilde{v})$, so the curvature vanishes on that half-ball. We can talk about the segment in the half-ball starting from the base point of \tilde{v}_∞ and orthogonal to the trajectory of \tilde{v}_∞ . Vectors based on that segment and parallel to \tilde{v}_∞ are accumulated by vectors generating geodesics in the flat strips bounding $\gamma_n(g_{t_n}\tilde{v})$. Hence the curvature vanishes along the geodesics starting from these vectors and we get a flat strip of width at least R .

If v_∞ lies on a periodic flat strip, the proof is finished. Assume therefore that the flat strip of v_∞ is not periodic.

The idea is now to use the nonperiodic flat strip of v to construct a flat strip of width strictly larger than R_{max} . By definition of R_{max} , this new flat strip is necessarily periodic, and we get the desired result.

The vectors $g_{t_n}v$ converges to v_∞ , so consider $t > 0$ so that the base point of g_tv is very close to the base point of v_∞ and the image of g_tv by the parallel transport from $T_{\pi(g_tv)}^1M$ to $T_{\pi(v)}^1M$ makes a small angle θ with v . Observe that this angle θ is nonzero. Indeed, otherwise, the flat strips bounded by $\gamma_n(g_{t_n}\tilde{v})$ and \tilde{v}_∞ would be parallel. The flat strip bounded by \tilde{v}_∞ would extend the flat strip bounded by $\gamma_n(g_{t_n}\tilde{v})$ by a quantity roughly equal to the distance between their base points, ensuring that the flat strip bounded by \tilde{v} is actually larger than R and contradicting the fact that R is the width of this flat strip.

Let us now consider a time t such that g_tv is close to v_∞ , with the angle between these two vectors denoted by $\theta > 0$. When the flat strip comes back close to v_∞ at time t , it cuts the boundary of the flat strip along a segment whose length is denoted by L . Without loss of generality, we may assume that v_∞ lies on the right boundary of its flat strip. Let us consider the highest rectangle of length $L/2$ that we can put at the end of this segment, on its right side, and that belongs to the returning flat strip of $g_t(v)$ but not to the flat strip of v_∞ . This rectangle is pictured below, its width is denoted by H .

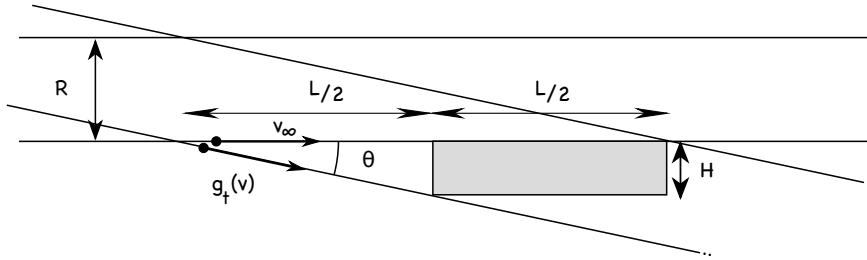

The quantities H and L can be computed using elementary euclidean trigonometry.

$$H = \frac{R}{2 \cos \theta} \geq \frac{R}{2}$$

$$L = \frac{R}{\sin \theta} \xrightarrow{\theta \rightarrow 0} +\infty$$

The same computation works when v_∞ is not on the boundary of its flat strip. The rectangle has a width bounded from below and a length going to infinity when θ goes to zero.

Every time the trajectory of v comes back near v_∞ , we get a new rectangle, and this gives a sequence of rectangles of increasing length right next to the flat strip. The next picture shows these rectangles in the universal cover \tilde{M} .

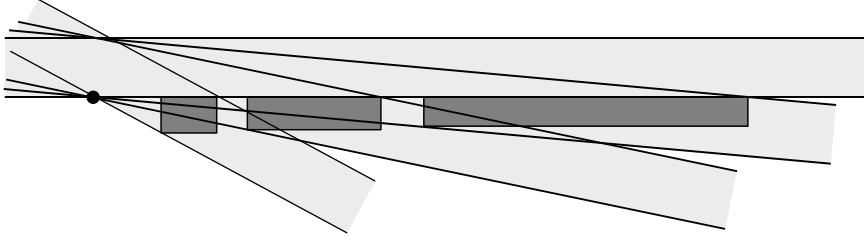

These rectangles are tangent to the flat strip of width R bounded by v_∞ , so that we get a sequence of flat rectangles of width $3R/2$ and length L going to infinity. By compactness of M , this sequence accumulates to some infinite flat strip of width $3R/2 > R_{max}$. Therefore this flat strip is periodic, by definition of R_{max} . This ends the proof.

4 The density of Dirac measures in $\mathcal{M}^1(\Omega_{NF})$

This section is devoted to the proof of proposition 2.4 and theorem 1.3.

4.1 Closing lemma, local product structure and transitivity

Let X be a metric space, and $(\phi^t)_{t \in \mathbb{R}}$ be a continuous flow acting on X . In this section, we recall three fundamental dynamical properties that we use in the sequel: the closing lemma, the local product structure, and transitivity.

When these three properties are satisfied on X , we proved in [CS10] (prop. 3.2 and corollary 2.3) that the conclusion of proposition 2.4 holds on X : the invariant probability measures supported by periodic orbits are dense in the set of all Borel invariant probability measures on X .

In [Pa61], Parthasarathy notes that the density of Dirac measures on periodic orbits is important to understand the dynamical properties of the invariant probability measures, and he asks under which assumptions it is satisfied. In the next sections, we will prove weakened versions of these three properties (closing lemma, local product and transitivity), and deduce proposition 2.4.

Definition 4.1 *A flow ϕ_t on a metric space X satisfies the closing lemma if for all points $v \in X$, and $\varepsilon > 0$, there exist a neighbourhood V of v , $\delta > 0$ and a $t_0 > 0$ such that for all $w \in V$ and all $t > t_0$ with $d(w, \phi_t w) < \delta$ and $\phi_t w \in V$, there exists p_0 and $l > 0$, with $|l - t| < \varepsilon$, $\phi_l p_0 = p_0$, and $d(\phi_s p_0, \phi_s w) < \varepsilon$ for $0 < s < \min(t, l)$.*

Definition 4.2 *The flow ϕ_t is said to admit a local product structure if all points $u \in X$ have a neighbourhood V which satisfies : for all $\varepsilon > 0$, there exists a positive constant δ , such that for all $v, w \in V$ with $d(v, w) \leq \delta$, there is a point $\langle v, w \rangle \in X$, a real number t with $|t| \leq \varepsilon$, so that:*

$$\langle v, w \rangle \in W_\varepsilon^{su}(\phi_t(v)) \cap W_\varepsilon^{ss}(w).$$

Definition 4.3 *The flow $(\phi^t)_{t \in \mathbb{R}}$ is transitive if for all non-empty open sets U and V of X , and $T > 0$, there is $t \geq T$ such that $\phi^t(U) \cap V \neq \emptyset$.*

Recall that if X is a G_δ subset of a complete separable metric space, then it is a Polish space, and the set $\mathcal{M}^1(X)$ of invariant probability measures on X is also a Polish space. As a result, the Baire theorem holds on this space [Bi99] th 6.8. In particular, this will be the case for the set $X = \Omega_{NF}$ when it is open in Ω , since Ω is a closed subset of T^1M .

If M is negatively curved, we saw in [CS10] that the restriction of $(g_t)_{t \in \mathbb{R}}$ to Ω satisfies the closing lemma, the local product structure, and is transitive. Note that we do not need any (lower or upper) bound on the curvature, i.e. we allow the curvature to go to 0 or to $-\infty$ in some noncompact parts of M . In particular, the conclusions of all theorems of this article apply to the geodesic flow on the nonwandering set of any nonelementary negatively curved manifold.

4.2 Closing lemma and transitivity on Ω_{NF}

We start by a proposition essentially due to G. Knieper ([K98] prop 4.1).

Proposition 4.4 *Let $v \in \Omega_{NF}$ be a recurrent vector which does not bound a flat strip. Then $v \in \Omega_{hyp}$, i.e. its strong stable (resp. unstable) manifold coincides with its stable (resp. unstable) horosphere.*

Proof : Let \tilde{M} the universal cover of M and $\tilde{v} \in T^1\tilde{M}$ be a lift of v . Assume that there exists $w \in T^1\tilde{M}$ which belongs to the stable horosphere, but not to the strong stable manifold of v . We can therefore find $c > 0$, such that $0 < c \leq d(g^t\tilde{v}, g^t\tilde{w}) \leq d(v, w)$, for all $t \geq 0$. Let us denote by Γ the deck transformation group of the covering $\tilde{M} \rightarrow M$. This group acts by isometries on $T^1\tilde{M}$. The vector v is recurrent, so there exists $\gamma_n \in \Gamma$, $t_n \rightarrow \infty$, with $\gamma_n(g^{t_n}\tilde{v}) \rightarrow \tilde{v}$. Therefore, for all $s \geq -t_n$, we have $c \leq d(g^{t_n+s}\tilde{v}, g^{t_n+s}\tilde{w}) = d(g^s\gamma_n g^{t_n}\tilde{v}, g^s\gamma_n g^{t_n}\tilde{w}) \leq d(v, w)$. Up to a subsequence, we can assume that $\gamma_n g^{t_n}\tilde{w}$ converges to a vector z . Then we have for all $s \in \mathbb{R}$, $0 < c \leq d(g^s\tilde{v}, g^s z) \leq d(v, w)$. The flat strip theorem shows that \tilde{v} bounds a flat strip (see e.g. [Ba95] cor 5.8). This concludes the proof. \square

In order to state the next result, we recall a definition. The ideal boundary of the universal cover, denoted by $\partial\tilde{M}$, is the set of equivalent classes of half geodesics that stay at a bounded distance of each other, for all positive t . We note u_+ the class associated to the geodesic $t \mapsto u(t)$, and u_- the class associated to the geodesic $t \mapsto u(-t)$.

Lemma 4.5 (Weak local product structure) *Let M be a complete, connected, nonpositively curved manifold, and v_0 be a vector that does not bound a flat strip.*

1. *For all $\varepsilon > 0$, there exists $\delta > 0$, such that if $v, w \in T^1M$ satisfy $d(v, v_0) \leq \delta$, $d(w, v_0) \leq \delta$, there exists a vector $u = \langle v, w \rangle$ satisfying $u^- = v^-$, $u^+ = v^+$, and $d(u, v_0) \leq \varepsilon$.*
2. *Moreover, if $v, w \in T_{hyp}$, then $u = \langle v, w \rangle \in T_{hyp}$.*

This lemma will be applied later to recurrent vectors that do not bound a flat strip; these are all in Ω_{hyp} .

Proof : The first item of this lemma is an immediate reformulation of [Ba95] lemma 3.1 page 50. The second item comes from the definition of the set T_{hyp} of vectors whose stable (resp. unstable) manifold coincide with the stable (resp. unstable) horosphere. \square

Note that *a priori*, the local product structure as stated in definition 4.2 and in [CS10] is not satisfied on Ω_{NF} : if v, w are in Ω_{NF} , the local product $\langle v, w \rangle$ does not necessarily belong to Ω_{NF} .

Lemma 4.6 *Let M be a nonpositively curved manifold such that Ω_{NF} is open in Ω . Then the closing lemma (see definition 4.1) is satisfied in restriction to Ω_{NF} .*

Proof : We adapt the argument of Eberlein [E96] (see also the proof of theorem 7.1 in [CS10]). Let $u \in \Omega_{NF}$, $\varepsilon > 0$ and U be a neighborhood of u in Ω . We can assume that $U \subset \Omega_{NF} \subset \Omega$ since Ω_{NF} is open in Ω . Given $v \in U \cap \Omega_{NF}$, with $d(g^t v, v)$ very small for some large t , it is enough to find a periodic orbit $p_0 \in U$ shadowing the orbit of v during a time $t \pm \varepsilon$. Since the sets Ω_{hyp} and Ω_{NF} have the same periodic orbits, we will deduce that $p_0 \in \Omega_{hyp} \subset \Omega_{NF}$.

Choose $\varepsilon > 0$, and assume by contradiction that there exists a sequence (v_n) in Ω_{NF} , $v_n \rightarrow u$, and $t_n \rightarrow +\infty$, such that $d(v_n, g^{t_n} v_n) \rightarrow 0$, with no periodic orbit of length approximatively t_n shadowing the orbit of v_n .

Lift everything to $T^1 \tilde{M}$. There exists $\varepsilon > 0$, $\tilde{v}_n \rightarrow \tilde{u}$, $t_n \rightarrow +\infty$, and a sequence of isometries φ_n of \tilde{M} s.t. $d(\tilde{v}_n, \varphi_n \circ g^{t_n} \tilde{v}_n) \rightarrow 0$. Now, we will show that for n large enough, φ_n is an axial isometry, and find on its axis a vector \tilde{p}_n which is the lift of a periodic orbit of length $\omega_n = t_n \pm \varepsilon$ shadowing the orbit of v_n . This will conclude the proof by contradiction.

Let $\gamma_{\tilde{u}}$ be the geodesic determined by \tilde{u} , and u^\pm its endpoints at infinity, $x \in \tilde{M}$ (resp. x_n, y_n) the basepoint of \tilde{u} (resp. $\tilde{v}_n, g^{t_n} \tilde{v}_n$). As $\tilde{v}_n \rightarrow \tilde{u}$, $t_n \rightarrow +\infty$, $x_n \rightarrow x$, and $d(\varphi_n^{-1}(x_n), y_n) \rightarrow 0$, we see easily that $\varphi_n^{-1}(x) \rightarrow u^+$. Similary, $\varphi_n(x) \rightarrow u^-$.

Since \tilde{u} does not bound a flat strip, Lemma 3.1 of [Ba95] implies that for all $\alpha > 0$, there exist neighbourhoods $V_\alpha(u^-)$ and $V_\alpha(u^+)$ of u^- and u^+ respectively, in the boundary at infinity of \tilde{M} , such that for all $\xi^- \in V_\alpha(u^-)$ and $\xi^+ \in V_\alpha(u^+)$, there exists a geodesic joining ξ^- and ξ^+ and at distance less than α from $x = \gamma_{\tilde{u}}(0)$.

Choose $\alpha = \varepsilon/2$. We have $\varphi_n(x) \rightarrow u^-$ and $\varphi_n^{-1}(x) \rightarrow u^+$, so for n large enough, $\varphi_n(V_{\varepsilon/2}(u^-)) \subset V_{\varepsilon/2}(u^-)$ and $\varphi_n^{-1}(V_{\varepsilon/2}(u^+)) \subset V_{\varepsilon/2}(u^+)$. By a fixed point argument, we find two fixed points $\xi_n^\pm \in V_{\varepsilon/2}(u^\pm)$ of φ_n , so that φ_n is an axial isometry.

Consider the geodesic joining ξ_n^- to ξ_n^+ given by W. Ballmann's lemma. It is invariant by φ_n , which acts by translation on it, so that it induces on M a periodic geodesic, and on $T^1 M$ a periodic orbit of the geodesic flow. Let p_n be the vector of this orbit minimizing the distance to u , and ω_n its period. The vector p_n is therefore close to v_n , and its period close to t_n , because $d\varphi_n^{-1}(\tilde{p}_n) = g^{\omega_n} \tilde{p}_n$ projects on $T^1 M$ to p_n , $d\varphi_n^{-1}(\tilde{v}_n) = g^{t_n} \tilde{v}_n$ projects to $g^{t_n} v_n$, $d(g^{t_n} v_n, v_n)$ is small, and φ_n is an isometry. Thus, we get the desired contradiction. \square

Lemma 4.7 (Transitivity) *Let M be a connected, complete, nonpositively curved manifold which contains at least three distinct periodic orbits that do not bound a flat strip. If Ω_{NF} is open in Ω , then the restriction of the geodesic flow to any of the two sets Ω_{NF} or Ω_{hyp} is transitive.*

Transitivity of the geodesic flow on Ω was already known under the so-called duality condition, which is equivalent to the equality $\Omega = T^1 M$ (see [Ba95] for details and references). In that case, Ω_{hyp} is dense in $T^1 M$.

Proof : Let U_1 and U_2 be two open sets in Ω_{NF} . Let us show that there is a trajectory in Ω_{NF} that starts from U_1 and ends in U_2 . This will prove transitivity on Ω_{NF} .

The closing lemma implies that periodic orbits in Ω_{hyp} are dense in Ω_{NF} and Ω_{hyp} . So we can find two periodic vectors v_1 in $\Omega_{hyp} \cap U_1$, and v_2 in $\Omega_{hyp} \cap U_2$. Let us assume that v_2 is not opposite to v_1 or an iterate of v_1 : $-v_2 \notin \cup_{t \in \mathbf{R}} g_t(\{v_1\})$. Then there is a vector $v_3 \in T^1 M$ whose trajectory is negatively asymptotic to the trajectory of v_1 and positively asymptotic to the trajectory of v_2 , cf [Ba95] lemma 3.3. Since v_1 and v_2 are in Ω_{hyp} , the vector v_3 also belongs to T_{hyp} , and therefore does not bound a periodic flat strip.

Let us show that v_3 is nonwandering. First note that there is also a trajectory negatively asymptotic to the negative trajectory of v_2 and positively asymptotic to the trajectory of v_1 . That is, the two periodic orbits v_1, v_2 are connected as pictured below.

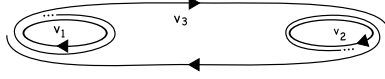

This implies that the two connecting orbits are nonwandering: indeed, using the local product structure, we can glue the two connecting orbits to obtain a trajectory that starts close to v_3 , follows the second connecting orbit, and then follows the orbit of v_3 , coming back to the vector v_3 itself. Hence v_3 is in Ω . Since it is in T_{hyp} it belongs to $\Omega_{hyp} \subset \Omega_{NF}$ and we are done.

If v_1 and v_2 generate opposite trajectories, then we take a third periodic vector w that does not bound a flat strip, and connect first v_1 to w then w to v_2 . Using again the product structure, we can glue the connecting orbits to create a nonwandering trajectory from U_1 to U_2 . \square

Remark 4.8 We note that without any topological assumption on Ω_{NF} , the same argument gives transitivity of the geodesic flow on the closure of the set of periodic hyperbolic vectors.

4.3 Density of Dirac measures on periodic orbits

Let us now prove proposition 2.4, that states the following:

Let M be a connected, complete, nonpositively curved manifold, which admits at least three different periodic orbits that do not bound a flat strip. Assume that Ω_{NF} is open in Ω . Then the Dirac measures supported by the periodic orbits of the geodesic flow $(g^t)_{t \in \mathbb{R}}$ that are in Ω_{NF} , are dense in the set of all invariant probability measures defined on Ω_{NF} .

Proof : We first show that Dirac measures on periodic orbits not bounding a flat strip are dense in the set of ergodic invariant probability measures on Ω_{NF} .

Let μ be an ergodic invariant probability measure supported by Ω_{NF} . By Poincaré and Birkhoff theorems, μ -almost all vectors are recurrent and generic w.r.t. μ . Let $v \in \Omega_{NF}$ be such a recurrent generic vector w.r.t. μ that belongs to Ω_{NF} . The closing lemma 4.6 gives a periodic orbit close to v . Since Ω_{NF} is open in Ω , that periodic orbit is in fact in Ω_{NF} . The Dirac measure on that orbit is close to μ and the claim is proven.

The set $\mathcal{M}^1(\Omega)$ is the convex hull of the set of invariant ergodic probability measures, so the set of convex combinations of periodic measures not bounding a flat strip is dense in the set of all invariant probability measures on Ω_{NF} . It is therefore enough to prove that periodic measures not bounding a flat strip are dense in the set of convex combinations of such measures. The argument follows [CS10], with some subtle differences.

Let $x_1, x_3, \dots, x_{2n-1}$ be periodic vectors of Ω_{NF} with periods $l_1, l_3, \dots, l_{2n-1}$, and $c_1, c_3, \dots, c_{2n-1}$ positive real numbers with $\sum c_{2i+1} = 1$. Let us denote the Dirac measure on the orbit of a periodic vector p by δ_p . We want to find a periodic vector p such that δ_p is close to the sum $\sum c_{2i+1} \delta_{x_{2i+1}}$. The numbers c_{2i+1} may be assumed to be rational numbers of the form p_{2i+1}/q . Recall that the x_i are in fact in Ω_{hyp} .

The flow is transitive on Ω_{NF} (lemma 4.7), hence for all i , there is a vector $x_{2i} \in \Omega_{NF}$ close to x_{2i-1} whose trajectory becomes close to x_{2i+1} , say, after time t_{2i} . We can also find a point x_{2n} close to x_{2n-1} whose trajectory becomes close to x_1 after some time. The proof of lemma 4.7 actually tells us that the x_{2i} can be chosen in Ω_{hyp} .

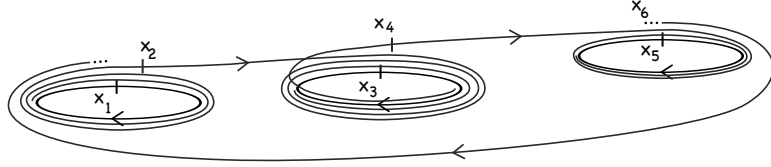

Now these trajectories can be glued together, using the local product on Ω_{hyp} (lemma 4.5) in the neighbourhood of each $x_{2i+1} \in \Omega_{hyp}$, as follows: we fix an integer N , large enough. First glue the piece of periodic orbit starting from x_1 , of length Nl_1p_1 , together with the orbit of x_2 , of length t_2 . The resulting orbit ends in a neighbourhood of x_3 , and that neighbourhood does not depend on the value of N . This orbit is glued with the trajectory starting from x_3 , of length Nl_2p_2 , and so on (See [C04] for details).

We end up with a vector close to x_1 , whose trajectory is negatively asymptotic to the trajectory of x_1 , then turns Np_1 times around the first periodic orbit, follows the trajectory of x_2 until it reaches x_3 ; then it turns Np_3 times around the second periodic orbit, and so on, until it reaches x_{2n} and goes back to x_1 , winding up on the trajectory of x_1 . The resulting trajectory is in T_{hyp} and, repeating the argument from Lemma 4.7, we see that it is nonwandering.

Finally, we use the closing lemma on Ω_{NF} to obtain a periodic orbit in Ω_{NF} . When N is large, the time spent going from one periodic orbit to another is small with respect to the time winding up around the periodic orbits, so the Dirac measure on the resulting periodic orbit is close to the sum $\sum_i c_{2i+1} \delta_{x_{2i+1}}$ and the theorem is proven.

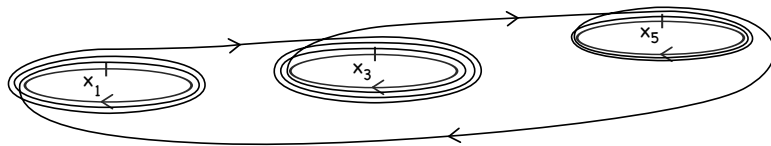

□

The proof of theorem 1.3 is then straightforward and follows verbatim from the arguments given in [CS10]. We sketch the proof for the comfort of the reader.

Proof : Proposition 2.4 ensures that ergodic measures are dense in the set of probability measures on Ω_{NF} . The fact that they form a G_δ -set is well known.

The fact that invariant measures of full support are a dense G_δ -subset of the set of invariant probability measures on Ω_{NF} is a simple corollary of the density of periodic orbits in Ω_{NF} , which itself follows from the closing lemma.

Finally, the intersection of two dense G_δ -subsets of $\mathcal{M}^1(\Omega_{NF})$ is still a dense G_δ -subset of $\mathcal{M}^1(\Omega_{NF})$, because this set has the Baire property. This concludes the proof. □

4.4 Examples

We now build examples for which the hypotheses or results presented in that article do not hold.

We start by an example of a surface for which Ω_{NF} is not open in Ω . First we consider a surface made up of an euclidean cylinder put on an euclidean plane. Such surface is built by considering an horizontal line and a vertical line in the plane, and connecting them with a convex arc that is infinitesimally flat at its ends. The profile thus obtained is then rotated along the vertical axis. The negatively curved part is greyed in the figure below.

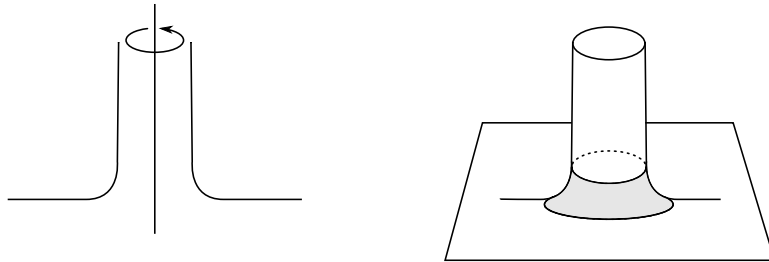

We can repeat that construction so as to line up cylinders on a plane. Let us use cylinders of the same size and shape, and take them equally spaced. The quotient of that surface by the natural \mathbf{Z} -action is a pair of pants, its three ends being euclidean flat cylinders.

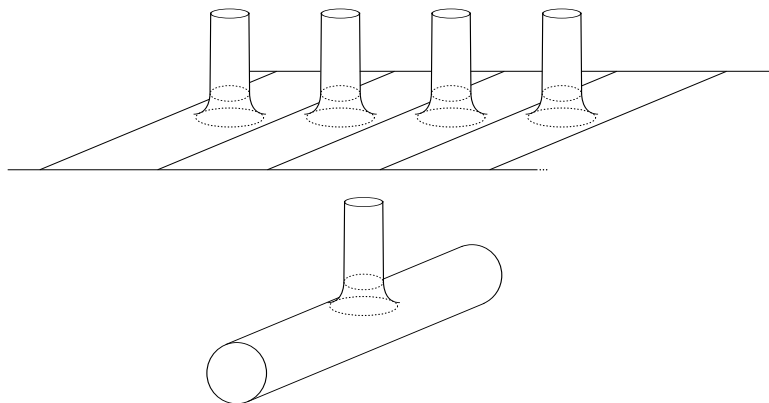

These cylinders are bounded by three closed geodesics that are accumulated by points of negative curvature. The nonwandering set of the \mathbf{Z} -cover is the inverse image of the nonwandering set of the pair of pants. As a result, the lift of the three closed geodesics to the \mathbf{Z} -cover are nonwandering geodesics. They are in fact accumulated by periodic geodesics turning around the cylinders a few times in the negatively curved part, cf [CS11], th. 4.2 ff. We end up with a row of cylinders on a strip bounded by two nonwandering geodesics. These are the building blocks for our example.

We start from an euclidean half-plane and pile up alternatively rows of cylinders with bounding geodesics γ_i and γ'_i , and euclidean flat strips. We choose the width so that the total sum of the widths of all strips is converging. We also increase the spacing between the cylinders from one strip to another so as to insure that they do not accumulate on the surface. The next picture is a top view of our surface, cylinders appear as circles.

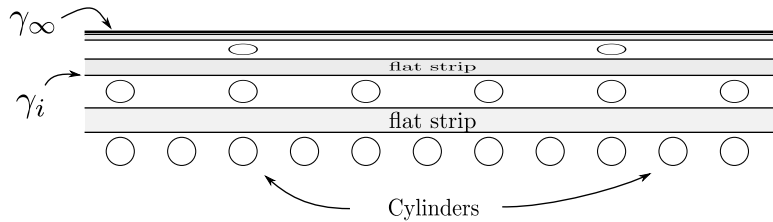

All the strips accumulate on a geodesic γ_∞ that is nonwandering because it is in the closure of the periodic geodesics. We can insure that it does not bound a flat strip by mirroring the construction on the other side of γ_∞ . So γ_∞ is in Ω_{NF} , and is approximated by geodesics γ_i that belong to Ω and bound a flat strip. Thus, Ω_{NF} is not open in Ω . We conjecture that ergodicity is a generic property in the set of all probability measures invariant by the geodesic flow on that surface. The flat strips should not matter here since they do not contain recurrent trajectories, but our method does not apply to that example.

The next example, due to Gromov [Gr78], is detailed in [Eb80] or [K98]. Let T_1 be a torus with one hole, whose boundary is homeomorphic to S^1 , endowed with a nonpositively curved metric, negative far from the boundary, and zero on a flat cylinder homotopic to the boundary. Let $M_1 = T_1 \times S^1$. Similarly, let T_2 be the image of T_1 under the symmetry with respect to a plane containing ∂T_1 , and $M_2 = S^1 \times T_2$. The manifolds M_1 and M_2 are 3-dimensional manifolds whose boundary is a euclidean torus. We glue them along this boundary to get a closed manifold M which contains around the place of gluing a thickened flat torus, isometric to $[-r, r] \times \mathbb{T}^2$, for some $r > 0$.

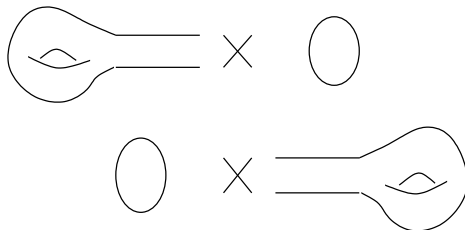

Figure 1: Manifold containing a thickened torus

Consider the flat 2-dimensional torus $\{0\} \times \mathbb{T}^2$ embedded in M . Choose an irrational direction $\{\theta\}$ on its unit tangent bundle and lift the normalized Lebesgue measure of the flat torus to the invariant set of unit tangent vectors pointing in this irrational direction θ . This measure is an ergodic invariant probability measure on T^1M , and the argument given in [CS11] shows that it is not in the closure of the set of invariant ergodic probability measures of full support. In particular, ergodic measures are not dense, and therefore not generic. Note also that this measure is in the closure of the Dirac orbits supported by periodic orbits bounding flat strips (we just approximate θ by a rational number), but cannot be approximated by Dirac orbits on periodic trajectories that do not bound flat strips.

This does not contradict our results though, because this measure is supported in $\Omega \setminus \Omega_{NF}$ (which is closed).

5 Measures with zero entropy

5.1 Measure-theoretic entropy

Let X be a Polish space, $(\phi^t)_{t \in \mathbb{R}}$ a continuous flow on X , and μ a Borel invariant probability measure on X . As the measure theoretic entropy satisfies the relation $h_\mu(\phi^t) = |t|h_\mu(\phi^1)$, we define here the entropy of the application $T := \phi^1$.

Definition 5.1 Let $\mathcal{P} = \{P_1, \dots, P_K\}$ be a finite partition of X into Borel sets. The entropy of the partition \mathcal{P} is the quantity

$$H_\mu(\mathcal{P}) = - \sum_{P \in \mathcal{P}} \mu(P) \log \mu(P).$$

Denote by $\bigvee_{i=0}^{n-1} T^{-i}\mathcal{P}$ the finite partition into sets of the form $P_{i_1} \cap T^{-1}P_{i_2} \cap \dots \cap T^{-n+1}P_{i_n}$. The measure theoretic entropy of $T = \phi^1$ w.r.t. the partition \mathcal{P} is defined by the limit

$$h_\mu(\phi^1, \mathcal{P}) = \lim_{n \rightarrow \infty} \frac{1}{n} H_\mu(\bigvee_{i=0}^{n-1} T^{-i}\mathcal{P}). \quad (1)$$

The measure theoretic entropy of $T = \phi^1$ is defined as the supremum

$$h_\mu(\phi^1) = \sup\{h_\mu(\phi^1, \mathcal{P}), \mathcal{P} \text{ finite partition}\}$$

The following result is classical [W82].

Proposition 5.2 Let $(\mathcal{P}_k)_{k \in \mathbb{N}}$ be a increasing sequence of finite partitions of X into Borel sets such that $\bigvee_{k=0}^{\infty} \mathcal{P}_k$ generates the Borel σ -algebra of X . Then the measure theoretic entropy of ϕ^1 satisfies

$$h_\mu(\phi^1) = \sup_{k \in \mathbb{N}} h_\mu(\phi^1, \mathcal{P}_k).$$

5.2 Generic measures have zero entropy

Theorem 5.3 Let M be a connected, complete, nonpositively curved manifold, whose geodesic flow admits at least three different periodic orbits, that do not bound a flat strip. Assume that Ω_{NF} is open in Ω . The set of invariant probability measures on Ω_{NF} with zero entropy is a dense G_δ subset of the set $\mathcal{M}^1(\Omega_{NF})$ of invariant probability measures supported in Ω_{NF} .

Recall here that on a nonelementary negatively curved manifold, $\Omega = \Omega_{NF}$ so that the above theorem applies on the full nonwandering set Ω .

The proof below is inspired from the proof of Sigmund [Si70], who treated the case of Axiom A flows on compact manifolds, and from results of Abdenur, Bonatti, Crovisier [ABC10] who considered nonuniformly hyperbolic diffeomorphisms on compact manifolds. But no compactness assumption is needed in our statement.

Proof : Remark first that on any Riemannian manifold M , if $B = B(x, r)$ is a small ball, $r > 0$ being strictly less than the injectivity radius of M at the point x , any geodesic (and in particular any periodic geodesic) intersects the boundary of B in at most two points. Lift now the ball B to the set T^1B of unit tangent vectors of T^1M with base points in B . Then the Dirac measure supported on any periodic geodesic intersecting B gives zero measure to the boundary of T^1B .

Choose a countable family of balls $B_i = B(x_i, r_i)$, with centers dense in M . Subdivide each lift T^1B_i on the unit tangent bundle T^1M into finitely many balls,

and denote by (\mathcal{B}_j) the countable family of subsets of T^1M that we obtain. Any finite family of such sets \mathcal{B}_j induces a finite partition of Ω_{NFP} into Borel sets (finite intersections of the \mathcal{B}_j 's, or their complements). Denote by \mathcal{P}_k the finite partition induced by the finite family of sets $(\mathcal{B}_j)_{0 \leq j \leq k}$. If the family \mathcal{B}_j is well chosen, the increasing sequence $(\mathcal{P}_k)_{k \in \mathbb{N}}$ is such that $\bigvee_{k=0}^{\infty} \mathcal{P}_k$ generates the Borel σ -algebra.

Set $X = \Omega_{NF}$. According to proposition 2.4, the family \mathcal{D} of Dirac measures supported on periodic orbits of X is dense in $\mathcal{M}^1(X)$. Denote by $\mathcal{M}_Z^1(X)$ the subset of probability measures with entropy zero in $\mathcal{M}^1(X)$. The family \mathcal{D} of Dirac measures supported on periodic orbits of X is included in $\mathcal{M}_Z^1(X)$, is dense in $\mathcal{M}^1(X)$, satisfies $\mu(\partial\mathcal{P}_k) = 0$ and $h_\mu(\mathcal{P}_k) = 0$ for all $k \in \mathbb{N}$ and $\mu \in \mathcal{D}$.

Fix any $\mu_0 \in \mathcal{D}$. Note that the limit in (1) always exists, so that it can be replaced by a \liminf . As μ_0 satisfies $\mu_0(\partial\mathcal{P}_k) = 0$, if a sequence $\mu_i \in \mathcal{M}^1(X)$ converges in the weak topology to μ_0 , it satisfies for all $n \in \mathbb{N}$, $H_{\mu_i}(\bigvee_{j=0}^n g^{-j}\mathcal{P}_k) \rightarrow H_{\mu_0}(\bigvee_{j=0}^n g^{-j}\mathcal{P}_k)$ when $i \rightarrow \infty$. In particular, the set

$$\left\{ \mu \in \mathcal{M}^1(X), H_\mu(\bigvee_{j=0}^n g^{-j}\mathcal{P}_k) < H_{\mu_0}(\bigvee_{j=-n}^n g^j\mathcal{P}_k) + \frac{1}{r} \right\},$$

for $r \in \mathbb{N}^*$, is an open set. We deduce that $\mathcal{M}_Z^1(X)$ is a G_δ -subset of $\mathcal{M}(X)$. Indeed,

$$\begin{aligned} \mathcal{M}_Z^1(X) &= \{ \mu \in \mathcal{M}^1(X), h_\mu(g^1) = 0 = h_{\mu_0}(g^1) \} \\ &= \bigcap_{k \in \mathbb{N}} \{ \mu \in \mathcal{M}^1(X), h_\mu(g^1, \mathcal{P}_k) = 0 = h_{\mu_0}(g^1, \mathcal{P}_k) \} \\ &= \bigcap_{k \in \mathbb{N}} \bigcap_{r=1}^{\infty} \left\{ \mu \in \mathcal{M}^1(X), 0 \leq h_\mu(g^1, \mathcal{P}_k) < \frac{1}{r} = h_{\mu_0}(g^1, \mathcal{P}_k) + \frac{1}{r} \right\} \\ &= \bigcap_{k \in \mathbb{N}} \bigcap_{r=1}^{\infty} \bigcap_{m=1}^{\infty} \bigcup_{n=m}^{\infty} \\ &\quad \left\{ \mu \in \mathcal{M}^1(X), \frac{1}{n+1} H_\mu(\bigvee_{j=0}^n g^{-j}\mathcal{P}_k) < \frac{1}{n+1} H_{\mu_0}(\bigvee_{j=0}^n g^{-j}\mathcal{P}_k) + \frac{1}{r} \right\}. \end{aligned}$$

The fact that $\mathcal{M}_Z^1(X)$ is dense is obvious because it contains the family \mathcal{D} of periodic orbits of X . \square

6 Mixing measures

6.1 Topological mixing

Let $(\phi^t)_{t \in \mathbb{R}}$ be a continuous flow on a Polish space X . The flow is said *topologically mixing* if for all open subsets U, V of X , there exists $T > 0$, such that for all $t \geq T$, $\phi^t U \cap V \neq \emptyset$. This property is of course stronger than transitivity: the flow is *transitive* if for all open subsets U, V of X , and all $T > 0$, there exists $t \geq T$, $\phi^t U \cap V \neq \emptyset$. An invariant measure μ under the flow is *strongly mixing* if for all Borel sets A and B we have $\mu(A \cap \phi^t B) \rightarrow \mu(A)\mu(B)$ when $t \rightarrow +\infty$.

An invariant measure cannot be strongly mixing if the flow itself is not topologically mixing on its support (see e.g. [W82]). We recall therefore some results about topological mixing, which are classical on negatively curved manifolds, and still true here.

Proposition 6.1 (Ballmann, [Ba82], rk 3.6 p. 54 and cor. 1.4 p.45) *Let M be a connected rank one manifold, such that all tangent vectors are nonwandering ($\Omega = T^1M$). Then the geodesic flow is topologically mixing.*

Also related is the work of M. Babillot [Ba01] who obtained the mixing of the measure of maximal entropy under suitable assumptions, with the help of a geometric cross ratio.

Proposition 6.2 *Let M be a connected, complete, nonpositively curved manifold, whose geodesic flow admits at least three distinct periodic orbits, that do not bound a flat strip. If Ω_{NF} is open in Ω , then the restriction of the geodesic flow to Ω_{NF} is topologically mixing iff the length spectrum of the geodesic flow restricted to Ω_{NF} is non arithmetic.*

Proof : Assume first that the geodesic flow restricted to Ω_{NF} is topologically mixing. The argument is classical. Let $u \in \Omega_{NF}$ be a vector, and $\varepsilon > 0$. Let $\delta > 0$ and $U \subset \Omega_{NF}$ be a neighbourhood of u of the form $U = B(u, \delta) \cap \Omega_{NF}$ where the closing lemma is satisfied (see lemma 4.6).

Topological mixing on Ω_{NF} implies that there exists $T > 0$, s.t. for all $t \geq T$, $g^t U \cap U \neq \emptyset$. Thus, for all $t \geq T$ there exists $v \in U \cap g^t U$, so that $d(g^t v, v) \leq \delta$.

We can apply the closing lemma to v , and obtain a periodic orbit of Ω_{NF} of length $t \pm \varepsilon$ shadowing the orbit of v during the time t . As it is true for all $\varepsilon > 0$ and large $t > 0$, it implies the non arithmeticity of the length spectrum of the geodesic flow in restriction to Ω_{NF} .

We assume now that the length spectrum of the geodesic flow restricted to Ω_{NF} is non arithmetic and we show that the geodesic flow is topologically mixing. In [D00], she proves this implication on negatively curved manifolds, by using intermediate properties of the strong foliation. We give here a direct argument.

- First, observe that it is enough to prove that for any open set $U \in \Omega_{NF}$, there exists $T > 0$, such that for all $t \geq T$, $g^t U \cap U \neq \emptyset$. Indeed, if U, V are two open sets of Ω_{NF} , by transitivity of the flow, there exists $u \in U$ and $T_0 > 0$ s.t. $g^{T_0} u \in V$. Now, by continuity of the geodesic flow, we can find a neighbourhood U' of u in U , such that $g^{T_0}(U') \subset V$. If we can prove that for all large $t > 0$, $g^t(U') \cap U' \neq \emptyset$, we obtain that for all large $t > 0$, $g^t U \cap V \neq \emptyset$.

- Fix an open set $U \subset \Omega_{NF}$. Periodic orbits of Ω_{hyp} are dense in Ω_{NF} . Choose a periodic orbit $p \in U \cap \Omega_{hyp}$. As U is open, there exists $\varepsilon > 0$, such that $g^t p \in U$, for all $t \in [-3\varepsilon, 3\varepsilon]$. By non arithmeticity of the length spectrum, there exists another periodic vector $p_0 \in \Omega_{hyp}$, and positive integers $n, m \in \mathbb{Z}$, $|nl(p) - ml(p_0)| < \varepsilon$. Assume that $0 < nl(p) - ml(p_0) < \varepsilon$.

- By transitivity of the geodesic flow on Ω_{NF} , and local product choose a vector v negatively asymptotic to the negative geodesic orbit of p and positively asymptotic to the geodesic orbit of p_0 , and a vector w negatively asymptotic to the orbit of p_0 and positively asymptotic to the orbit of p . By lemma 4.5 (2), v and w are in T_{hyp} . Moreover, they are nonwandering by the same argument as in the proof of lemma 4.7. Using the local product structure and the closing lemma, we can construct for all positive integers $k_1, k_2 \in \mathbb{N}^*$ a periodic vector p_{k_1, k_2} at distance less than ε of p , whose orbit turns k_1 times around the orbit of p , going from an ε -neighbourhood of p to an ε -neighbourhood of p_0 , with a “travel time” $\tau_1 > 0$, turning around the orbit of p_0 k_2 times, and coming back to the ε -neighbourhood of p , with a travel time τ_2 . Moreover, τ_1 and τ_2 are independent of k_1, k_2 and depend only on ε , and on the initial choice of v and w . The period of p_{k_1, k_2} is $k_1 l(p) + k_2 l(p_0) + C(\tau_1, \tau_2, \varepsilon)$, where C is a constant, and $g^\tau p_{k_1, k_2}$ belongs to U for all $\tau \in]-\varepsilon, \varepsilon[$.

- Now, by non arithmeticity, there exists $T > 0$ large enough, s.t. the set $\{k_1 l(p) + k_2 l(p_0) + C(\tau_1, \tau_2, \varepsilon), k_1 \in \mathbb{N}, k_2 \in \mathbb{N}\}$ is ε -dense in $[T, +\infty[$. To check it, let K_0 be the largest integer such that $K_0(nl(p) - ml(p_0)) < ml(p_0)$. Observe then that for all positive integer $i \geq 1$, and all $0 \leq j \leq K_0 + 1$, the set of points $(K_0 + i)ml(p_0) + j(nl(p) - ml(p_0)) = (K_0 + i - j)ml(p_0) + jnl(p)$ is ε -dense in $[(K_0 + i)ml(p_0), (K_0 + i + 1)ml(p_0)]$.

As $g^\tau p_{k_1, k_2}$ belongs to U for all $\tau \in]-\varepsilon, \varepsilon[$, it proves that for all $t \geq T$, $g^t U \cap U \neq \emptyset$. \square

6.2 Strong mixing

Even in the case of a topologically mixing flow, generic measures are not strongly mixing, according to the following result.

Theorem 6.3 *Let $(\phi^t)_{t \in \mathbb{R}}$ be a continuous flow on a complete separable metric space X . If the Dirac measures supported by periodic orbits are dense in the set of invariant probability measures on X , then the set of invariant measures which are not strongly mixing contains a dense G_δ -subset of the set of invariant probability measures on X .*

This result was first proven by K. R. Parthasarathy in the context of discrete symbolic dynamical systems [Pa61]. We adapt here the argument in the setting of flows. Thanks to proposition 2.4 we obtain:

Corollary 6.4 *Let M be a complete, connected, nonpositively curved manifold with at least three different periodic orbits, that do not bound a flat strip. If Ω_{NF} is open in Ω , then the set of invariant measures which are not strongly mixing contains a dense G_δ -subset of the set of invariant probability measures on Ω .*

Proof : Choose a countable dense set of points $\{x_i\}$, and let \mathcal{A} be the countable family of all closed balls of rational radius centered at a point x_i . This family generates the Borel σ -algebra of $T^1 M$. A measure μ is a strongly mixing measure if for any set $F \in \mathcal{A}$ such that $\mu(F) > 0$, we have $\mu(F \cap \phi^t F) \rightarrow \mu(F)^2$ when $t \rightarrow \infty$.

For any subset $F_1 \in \mathcal{A}$, let $G_n = V_{\frac{1}{n}}(F_1)$ be a decreasing sequence of open neighbourhoods of F_1 with intersection $\overline{F_1}$. The set of strongly mixing measures is included in the following union (where all indices n, ε, η, r are rational numbers, t is a real number and F_1, F_2 are disjoint)

$$\bigcup_{F_1, F_2 \in \mathcal{A}} \bigcup_{n \in \mathbb{N}^*} \bigcup_{\varepsilon \in (0,1)} \bigcup_{0 < \eta < 2\varepsilon^2/3} \bigcup_{r \in (0,1)} \bigcup_{m \in \mathbb{N}} \bigcap_{t \geq m} A_{F_1, F_2, n, \varepsilon, \eta, r, m, t}$$

with $A_{F_1, F_2, n, \varepsilon, \eta, r, m, t} \subset \mathcal{M}(X)$ given by

$$\{\mu \in \mathcal{M}(X) \mid \mu(F_1) \geq \varepsilon, \mu(F_2) \geq \varepsilon, \mu(G_n \cap \phi^k G_n) \leq r, r \leq \mu^2(F_1) + \eta\}.$$

This set is closed, because G_n is an open set, and F_1, F_2 are closed. (The second closed set F_2 is disjoint from F_1 and is just used to guarantee that F_1 is not of full measure). The intersection of all such sets over all $t \geq m$ is still closed. The set of strongly mixing measures is therefore included in a countable union of closed sets.

Let us show that each of these closed sets has empty interior. Denote by $\mathcal{E}(F_1, F_2, G_n, \varepsilon, r, m)$ the set

$$\bigcap_{t \geq m} \{\mu \in \mathcal{M}(X) \mid \mu(F_1) \geq \varepsilon, \mu(F_2) \geq \varepsilon, \mu(G_n \cap \phi^t G_n) \leq r, r \leq \mu^2(F_1) + \eta\}.$$

It is enough to show that its complement contains all periodic measures. Remark first that if μ is a Dirac measure supported on a periodic orbit of length l , then for all Borel sets $A \subset X$, and all multiples jl of the period,

$$\mu(A \cap \phi^{jl} A) = \mu(A).$$

In particular, they are obviously not mixing.

Let μ_0 be a periodic measure of period $l > 0$, and $j \geq 1$ an integer s.t. $jl \geq m$. Let us show that it does not belong to the following set:

$$\{\mu \in \mathcal{M}(X), \mu(F_1) \geq \varepsilon, \mu(F_2) \geq \varepsilon, \mu(G_n \cap \phi^{jl}G_n) \leq r, r \leq \mu^2(F_1) + \eta\}.$$

If $\mu_0(F_1) \geq \varepsilon$ and $\mu_0(F_2) \geq \varepsilon$, we get $\varepsilon \leq \mu_0(F_1) \leq 1 - \varepsilon$. The key property of μ_0 gives $\mu_0(G_n \cap \phi^{jl}G_n) = \mu_0(G_n)$. We deduce that

$$\begin{aligned} \mu_0(G_n \cap \phi^{jl}G_n) - \mu_0(F_1)^2 &= \mu_0(G_n) - \mu_0(F_1)^2 \geq \mu_0(F_1)(1 - \mu_0(F_1)) \geq \varepsilon(1 - \varepsilon) \\ &\geq \varepsilon^2 > \frac{3\eta}{2} > \eta \end{aligned}$$

so that μ_0 does not belong to the above set. In particular, the periodic measures do not belong to $\mathcal{E}(F_1, F_2, G_n, \varepsilon, r, m)$ and the result is proven. \square

6.3 Weak mixing

We end with a question concerning the weak-mixing property. An invariant measure μ on X is *weakly mixing* if for all continuous function with compact support f defined on X , we have

$$\lim_{T \rightarrow \infty} \frac{1}{T} \int_0^T \left| \int_X f \circ \phi^t(x) f(x) d\mu(x) - \left(\int_X f d\mu \right)^2 \right| dt = 0. \quad (2)$$

Theorem 6.5 (Parthasarathy, [Pa62]) *Let $(\phi^t)_{t \in \mathbb{R}}$ be a continuous flow on a Polish space. The set of weakly mixing measures on X is a G_δ -subset of the set of Borel invariant probability measures on X .*

Of course, this result applies in our context, with $X = \Omega$, or $X = \Omega_{NF}$.

In the case of the dynamics on a full shift, Parthasarathy proved in [Pa62] that there exists a dense subset of strongly mixing measures. This result was improved by Sigmund [Si72] who showed that there is a dense subset of Bernoulli measures. Of course, these results imply in particular that the above G_δ -set is a dense G_δ -subset of $\mathcal{M}(\Omega)$. But the methods of [Pa62] and [Si72] strongly use specific properties of a shift dynamics, and seem therefore difficult to generalize. In any case, such a result would impose to add the assumption that the flow is topologically mixing.

Anyway, the following question is interesting: in the setting of noncompact rank one manifold, can we find a dense family of weakly mixing measures on Ω_{NF} ? Or at least one?

We recall briefly the proof of the above theorem for the reader. The arguments are similar to those of [Pa62], but our formulation is shorter.

Proof: It is classical that the weak mixing of the system (X, ϕ, μ) is equivalent to the ergodicity of $(X \times X, \phi \times \phi, \mu \times \mu)$ (see e.g. [W82]).

Let $(f_i)_{i \in \mathbb{N}}$ be some countable algebra of Lipschitz bounded functions on $X \times X$ separating points. Such a family is dense in the set of all bounded Borel functions, with respect to the $L^2(m)$ norm, for all Borel probability measures m on $X \times X$ (see [C02] for a short proof). Now, the complement of the set of weakly mixing measures $\mu \in \mathcal{M}(X)$ can be written as the union of the following sets:

$$\begin{aligned} F_{k,l,i} &= \{\mu \in \mathcal{M}(X), \exists m_1, m_2 \in \mathcal{M}(X \times X), \alpha \in [\frac{1}{k}, 1 - \frac{1}{k}], s.t. \\ &\mu \times \mu = \alpha m_1 + (1 - \alpha)m_2, \text{ and } \int f_i dm_1 \geq \int f_i dm_2 + \frac{1}{l}\}. \end{aligned}$$

We check as in [CS10] that these sets are closed, so that the weakly mixing measures of X form a G_δ -subset of $\mathcal{M}(X)$. \square

References

- [ABC10] F. Abdenur, C. Bonatti, S. Crovisier. Nonuniform hyperbolicity for C^1 -generic diffeomorphisms, *Israel Journal of Maths* **183** (2011), 160.
- [Ba01] M. Babillot. On the mixing property for hyperbolic systems *Israel J. Math.* **129** (2002), 61–76.
- [Ba82] W. Ballmann, Axial isometries of manifolds of nonpositive curvature. *Math. Annalen* **259** (1982), 131–144.
- [Ba95] W. Ballmann. Lectures on spaces of nonpositive curvature. With an appendix by Misha Brin. *DMV Seminar, 25. Birkhuser Verlag, Basel* (1995).
- [BB82] W. Ballmann; M. Brin. On the ergodicity of geodesic flows. *Ergodic theory and Dynamical Systems*, (1982) 311–315.
- [Bi99] P. Billingsley. Convergence of probability measures. Second edition. Wiley Series in Probability and Statistics: Probability and Statistics. A Wiley-Interscience Publication. John Wiley & Sons, Inc., New York, 1999.
- [C02] Y. Coudene. Une version mesurable du théorème de Stone-Weierstrass. *Gazette des mathématiciens*, no. **91** (2002), 10–17
- [C04] Y. Coudene. Topological dynamics and local product structure. *J. London Math. Soc. (2)* **69**, no.2 (2004), 441–456.
- [CS10] Y. Coudene, B. Schapira. Generic measures for hyperbolic flows on non-compact spaces, *Israel Journal of Maths*, **179** (2010), 157–172.
- [CS11] Y. Coudene, B. Schapira. Counterexamples in nonpositive curvature, to appear in *Discrete and continuous dynamical systems* (2011).
- [D99] F. Dal’bo. Remarques sur le spectre des longueurs d’une surface et comptages. *Bol. Soc. Bras. Math.* **30**, no.2 (1999), 199–221.
- [D00] F. Dal’bo. Topologie du feuilletage fortement stable. *Ann. Inst. Fourier* (Grenoble) **50**, no.3 (2000), 981–993.
- [Eb80] Eberlein, Patrick B. Lattices in spaces of nonpositive curvature. *Annals of Maths.* **111** no.3, 435-476.
- [E96] P. Eberlein. Geometry of nonpositively curved manifolds. Chicago Lectures in Mathematics. University of Chicago Press, Chicago, IL, 1996. vii+449 pp.
- [Gr78] Gromov, Mikhail. Manifolds of negative curvature. *J. Diff. Geom.* **13** (1978), 231–242.
- [K98] G. Knieper. The uniqueness of the measure of maximal entropy for geodesic flows on rank 1 manifolds. *Ann. of Math. (2)* **148**, no.1 (1998), 291–314.
- [K02] G. Knieper. Hyperbolic dynamics and Riemannian geometry. Handbook of dynamical systems, Vol. 1A, 453–545, North-Holland, Amsterdam, 2002.
- [Pa61] K.R. Parthasarathy. On the category of ergodic measures. *Illinois J. Math.* **5** (1961), 648–656.
- [Pa62] K.R. Parthasarathy. A note on Mixing Processes. *Sankhya, The Indian journal of Statistics*, Series A, vol 24, no. 4 (nov. 1962), 331–332.

- [P77] Y. Pesin. Geodesic flow on closed Riemannian manifold without focal points. *Math. USSR Izvestija* **11** (1977), 1195–1228.
- [Si70] K. Sigmund. Generic properties of invariant measures for Axiom A-Diffeomorphisms. *Inventiones math.* **11** (1970), 99–109.
- [Si72] K. Sigmund. On mixing measures for Axiom A Diffeomorphisms. *Proceedings of the American Math. Soc.* **36**, no.2 (1972).
- [Si72] K. Sigmund. On the space of invariant measures for hyperbolic flows. *Amer. J. Math.* **94** (1972), 3137.
- [W82] P. Walters. An introduction to ergodic theory. Graduate Texts in Mathematics, 79. Springer-Verlag, New York-Berlin, 1982.