



HAL
open science

SiPM cryogenic operation down to 77 K

D. Prêle, D. Franco, Dominique Ginhac, Khalil Jradi, F. Lebrun, S. Perasso,
Denis Pellion, A. Tonazzo, F. Voisin

► **To cite this version:**

D. Prêle, D. Franco, Dominique Ginhac, Khalil Jradi, F. Lebrun, et al.. SiPM cryogenic operation down to 77 K. 10th International Workshop On Low Temperatures Electronics (WOLTE10), Oct 2013, Paris, France. pp.30-34. hal-00932628

HAL Id: hal-00932628

<https://hal.science/hal-00932628v1>

Submitted on 22 Jan 2014

HAL is a multi-disciplinary open access archive for the deposit and dissemination of scientific research documents, whether they are published or not. The documents may come from teaching and research institutions in France or abroad, or from public or private research centers.

L'archive ouverte pluridisciplinaire **HAL**, est destinée au dépôt et à la diffusion de documents scientifiques de niveau recherche, publiés ou non, émanant des établissements d'enseignement et de recherche français ou étrangers, des laboratoires publics ou privés.

SiPM cryogenic operation down to 77 K

D. Prêle¹, D. Franco¹, D. Ginjac², K. Jradi², F. Lebrun¹, S. Perasso¹,
D. Pellion², A. Tonazzo¹, F. Voisin¹,

¹APC, Univ. Paris Diderot, CNRS/IN2P3, CEA/Irfu, Obs. de Paris, Sorbonne Paris Cité,
Paris, France

²Le2i, Univ. de Bourgogne, CNRS/INSIS-INS2I, Dijon, France

E-mail: damien.prele@apc.univ-paris7.fr

Abstract. Silicon PhotoMultiplier (SiPM) is composed of extremely sensitive photosensors based on the Geiger Mode Avalanche PhotoDiode (GM-APD), which operate as a digital pixel sensitive to single photons. SiPMs are being considered for applications in low temperature environments, such as noble-liquid detectors for dark matter searches or neutrino physics and GM-APD is promising technology for space Compton telescopes. While it is well known that the dark count rate, one of the main limitations of SiPM, is reduced at low temperature, a detailed study of the behavior of the device in cryogenic environment is necessary to assess its performances. In this paper, we present measurements of static parameters as breakdown voltage and quenching resistance of a commercial SiPM (Hamamatsu MPPC S10362-11-100C). Evolution of these parameters as well as junction capacitance between room temperature and 77 K is discussed.

1. Introduction

Silicon PhotoMultipliers (SiPMs) are being considered as possible photosensors for detectors operating at low temperatures, such as noble liquid (argon or xenon) time projection chambers for direct dark matter searches and neutrino detectors, or for Compton telescopes in space. A detailed study of their parameters in cryogenic environment are necessary to assess the expected performances.

A SiPM is composed of Geiger Mode Avalanche PhotoDiode (GM-APD). Geiger mode provides internal gain as large as 10^6 carriers per incident photon. By means of a self-sustaining avalanche process: successive impact ionizations of carriers are accelerated as long as the electric field is sufficient, above a voltage breakdown threshold (V_{BD}). The GM-APD current rises to the order of a milli-ampere in a few nano-seconds (rise time). This current passes through a quenching resistor [1] (R_Q in Fig. 1), placed in series with the voltage biasing, which has the effect of lowering the electric field in the GM-APD below the breakdown threshold. This causes the avalanche process to be turned out in few 10 ns (fall time). Without self-sustaining avalanche process and as long as there is no new incoming photon, the current drops below the pico-ampere level (leakages), and the GM-APD electric field is restored above the breakdown threshold. After this current pulse, the GM-APD is again ready to detect a new photon.

The main parameters of a GM-APD, and thus of a SiPM, are: the quenching resistance R_Q , influencing the fall time; the junction capacitance C_J , which limits the rise and fall times and the breakdown voltage V_{BD} . Rise and fall times are represented in the Figure 2. The differential

resistance of the junction R_{d_j} during the avalanche process is also an interesting parameter allowing to determine the rise time.

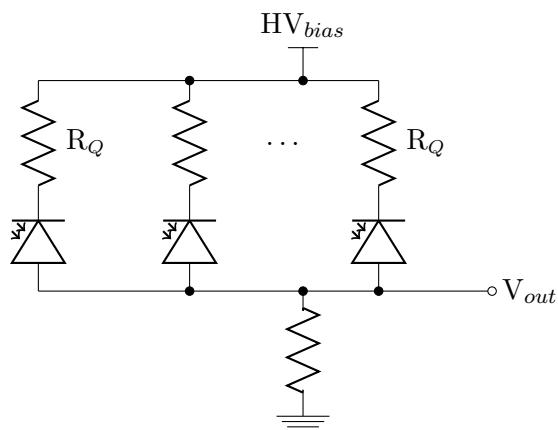

Figure 1. Electrical scheme of a SiPM showing the individual GM-APD and the quenching resistors R_Q . A small resistor (typically 50Ω) in series with the SiPM and the high voltage bias ($\approx 70 \text{ V}$ in the case of the MPPC) converts the current to voltage.

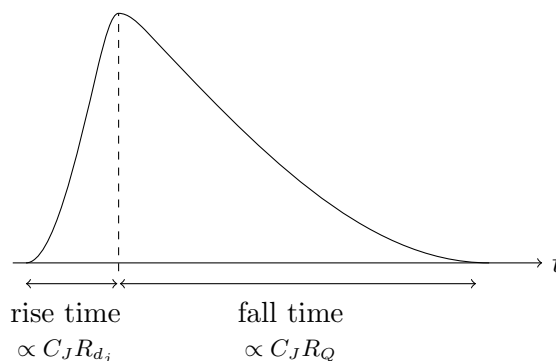

Figure 2. Typical current waveform crossing a GM-APD cell when photon is detected. A GM-APD pulse consists of two parts, rise and fall. The rise time depends to the value of the differential resistance R_{d_j} of the diode during the avalanche process and of the junction capacitor C_J , while the fall time depends to R_Q and C_J .

We determined the parameters V_{BD} , R_Q and C_J as a function of temperatures for a commercial SiPM, the Hamamatsu MPPC S10362-11-100C [2]. Most of parameters were extracted from the Current-Voltage characteristic ($I(V)$, see Fig. 3) from 300 K to 77 K. Only, junction capacitors is obtain from dynamic measurements. This allows us to know what kind of cryogenic operation we can expect from the photosensor in cooled environnements.

2. Quenching resistance extraction from the forward bias characteristic

Using the forward bias characteristic of the SiPM, it is possible to extract the value of the quenching resistor R_Q . We assume that N cells under forward bias are similar to a single diode in series with a R_Q/N resistor¹.

Following this method to extract R_Q , we have measured the forward characteristic of the MPPC S10362-11-100C from 300 K to 77 K. Figure 4 shows the $I(V)$ forward characteristics

¹ SiPM \equiv Diode + R_Q/N . Indeed, N diodes in parallel are equivalent to one diode with an area N times larger, where the small-signal equivalent resistance is always $r_d = \frac{kT}{qI}$ whatever N .

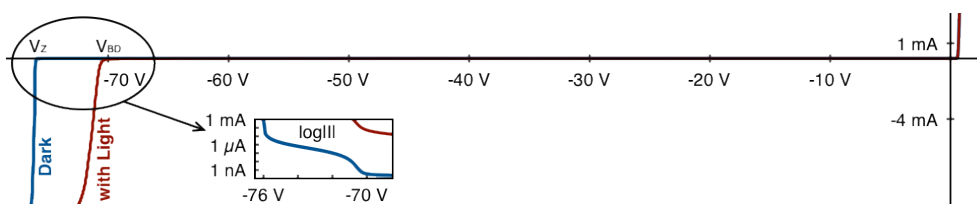

Figure 3. Typical SiPM $I(V)$ characteristic at 300 K with and without incident photons. A zoom around the breakdown voltage is also shown using a log scale of the current absolute value.

from room temperature to liquid nitrogen temperature. The slope of the curve is inversely proportional to the quenching resistance, so we clearly see that quenching resistance increases at low temperatures. Figure 5 shows the quenching resistance deduced from I(V) curves. It is noticeable that the quenching resistance increases more quickly as the temperature decreases and finally is 10 times larger at 77 K than at 300 K.

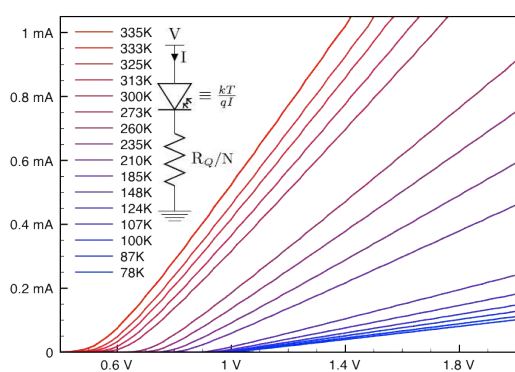

Figure 4. I(V) curves show that the quenching resistor increases at low temperature. Indeed, in an I(V) curve, the resistance is inversely proportional to the slope of the curve.

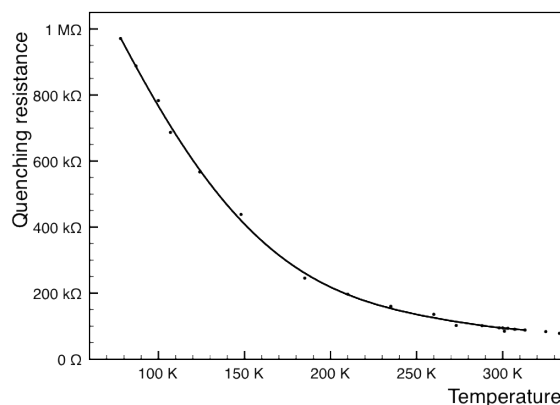

Figure 5. Quenching resistance R_Q as a function of the temperature. R_Q is extract from the figure 4 and by multiplying R_Q/N by the number of SiPM cells ($N=100$).

The quenching resistance (per cell) goes from 100 k Ω at room temperature to 1 M Ω at liquid nitrogen temperature. As a consequence, for a constant junction capacitance, the fall time will increase by an order of magnitude. This $R_Q(T)$ negative temperature coefficient could inhibit the quenching process. Indeed, during the fall time, the Joule heating could reduce the R_Q resistance and would lead to stay in the avalanche process. This is probably the effect that will be shown in the following section with the reverse bias characteristics (dashed line of Figure 6).

3. Breakdown voltage measurement from the reverse bias characteristic

Reverse bias characteristic is a common way to characterize SiPM and extract the breakdown voltage V_{BD} . As shown in figure 3, the measurement in the dark also allows us to know the maximum voltage biasing (V_Z^2) before SiPM self-triggering.

As it is shown in figure 6, at low temperature the photo-current is too small to be measured by our equipment (Agilent B1500A source measure unit with a noise floor ≈ 100 pA). Moreover, below 250 K, a "full SiPM latching process" trigs the overall cells unexpectedly above the breakdown voltage even without photon flux ("Dark"). The arbitrary voltage where this latching occurs suggests that it is a different phenomenon than the "Zener" threshold V_Z . Moreover, this phenomenon could be compatible with a positive electro-thermal feedback due to the negative temperature coefficient of the R_Q .

Nevertheless, using a light source to trigger the SiPM, it is possible to clearly see the breakdown voltage, as it shown in figure 6 - solid line. The breakdown voltage is measured and plotted as a function of the temperature in Figure 7. It appears that its evolution is close to a linear function ; with a temperature coefficient equal to -50 mV/K. V_{BD} decreases by more than 10 V (in absolute value) from room temperature to liquid nitrogen temperature.

² The Zener voltage V_Z corresponds to the breakdown voltage in the dark.

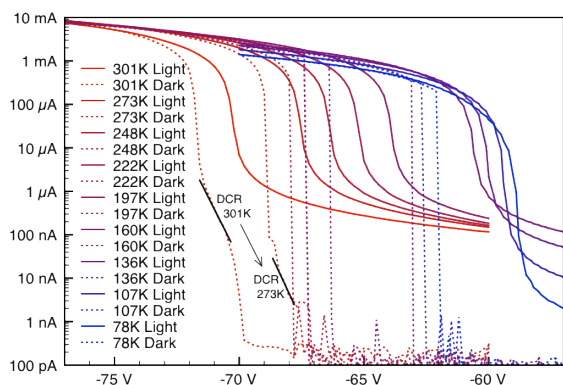

Figure 6. Reversed biased I(V) curves of the SiPM. To see small current phenomena a log scale is used, so in absolute value.

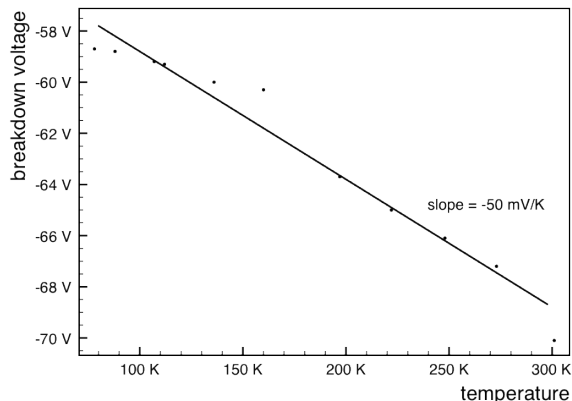

Figure 7. Breakdown voltage as a function of temperature. A linear fit gives a fluctuation of the breakdown voltage of -50 mV/K.

4. Dynamic characteristics

SiPMs are used to detect fast pulses, therefore a dynamic characterization is mandatory to determine the SiPM behavior. A small signal analysis allows one to extract the capacitance of the junction reverse biased.

Figure 8 shows the equivalent AC electrical model of the SiPM. R_{d_j} is the differential resistance of each junction and is only considered in presence of an avalanche process *ie* biased below V_{BD} (in absolute value). C_J is the junction capacitance, which is due to the depleted region of the APD. The thickness of this depleted layer is proportional to the reverse biasing, therefore the junction capacitor decreases as the reverse bias increases in absolute value. However, as is shown in figure 9, this value remains constant for voltage biases larger than 30 V. Moreover, above V_{BD} , the avalanche process prohibits the measurement of the junction capacitance due to the drop of the junction differential resistance.

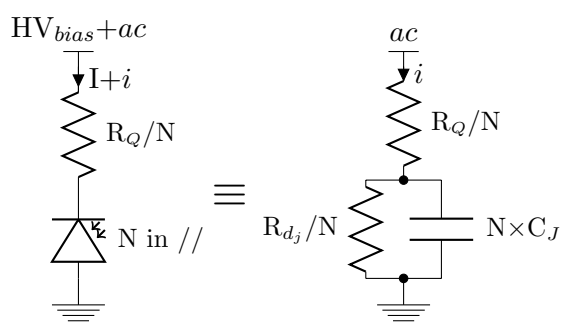

Figure 8. Small signal electrical schematic of a SiPM for *ac* measurement. R_{d_j} corresponds to the differential resistance of the GM-APD junction (without R_Q). C_J is the junction capacitor.

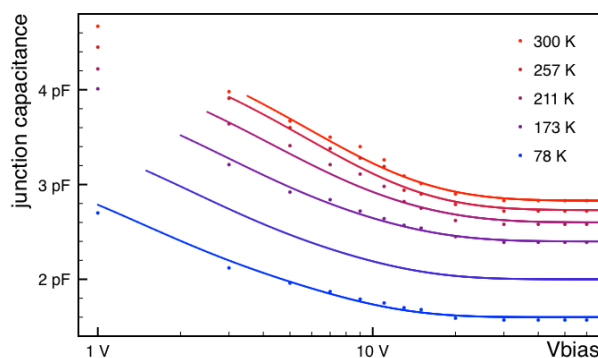

Figure 9. Evolution of the junction capacitance as a function of the voltage biasing and for different temperatures from room temperature to liquid nitrogen temperature.

The junction capacitance as a function of temperature, measured with a bias voltage of 60 V, is finally reported in figure 10. We clearly notice a decrease of the junction capacitance at low temperature. However, this decrease is less than a factor of 2 between 300 K and 77 K.

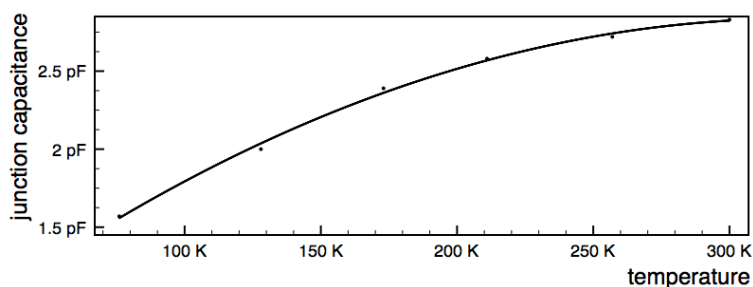

Figure 10. Junction capacitance as a function of the temperature. The measurement has been made with a 60 V biasing.

5. Conclusion

The breakdown voltage V_{BD} , the quenching resistance R_Q and the junction capacitance C_J of a commercial SiPM MPPC S10362-11-100C [2] have been measured at temperatures from 300 K to 77 K. A quasi-linear decreasing of the breakdown voltage with temperature is found, with a rate of -50 mV/K. The quenching resistance increases by a factor of 10 between 300 K to 77 K. Finally, the junction capacitance decreases by less than a factor of 2 in the same temperature range. These experimental results give a good idea of the voltage biasing required for MPPC cryogenic operation. Furthermore, they allow us to predict a fall time increase by a factor of 5 at liquid nitrogen temperature. Moreover, these tests clearly point out a phenomenon of "full triggering" of the tested SiPM at low temperature and for biasing just above the breakdown voltage. Therefore, the biasing voltage range seems to be strongly reduced at cryogenic temperatures.

Most of these results has been obtained by using "simple" I(V) measurements and are fully compatible with similar measurements using time response [3].

Acknowledgments

Measurements presented in this paper has been made with the help of B. Manceur during its master degree internship at APC. Authors are also grateful to M. Piat, who provided part of the cryogenic equipment needed for this study.

References

- [1] Cova S. et al 1996 *Avalanche photodiodes and quenching circuits for single-photon detection* (Applied Optics, Vol. 35 No 12)
- [2] HAMAMATSU datasheet, *MPPC (multi-pixel photon counter) - S10362-11 series*
- [3] Otono H. et al 2007 *Study of MPPC at Liquid Nitrogen Temperature* (International Workshop on new Photon-Detectors, Kobe, Japan)