



# A smart camera for High Dynamic Range imaging

Pierre-Jean Lapray, Barthélémy Heyrman  
and Dominique Ginjac  
LE2I, University of Burgundy, DIJON

**WASC'13:** WORKSHOP ON ARCHITECTURE OF SMART CAMERA  
3-4 JUNE 2013, SEVILLA - SPAIN





# HIGH DYNAMIC RANGE IMAGING (HDR)

- ✘ Dynamic range is the ratio between the maximum (white) and the minimum (black) measurable light intensities.

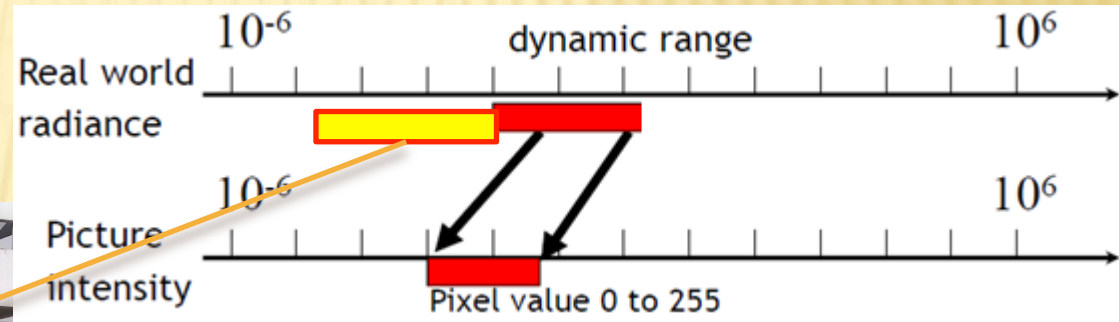

# HIGH DYNAMIC RANGE IMAGING (HDR)

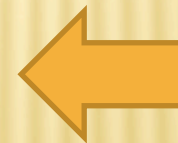
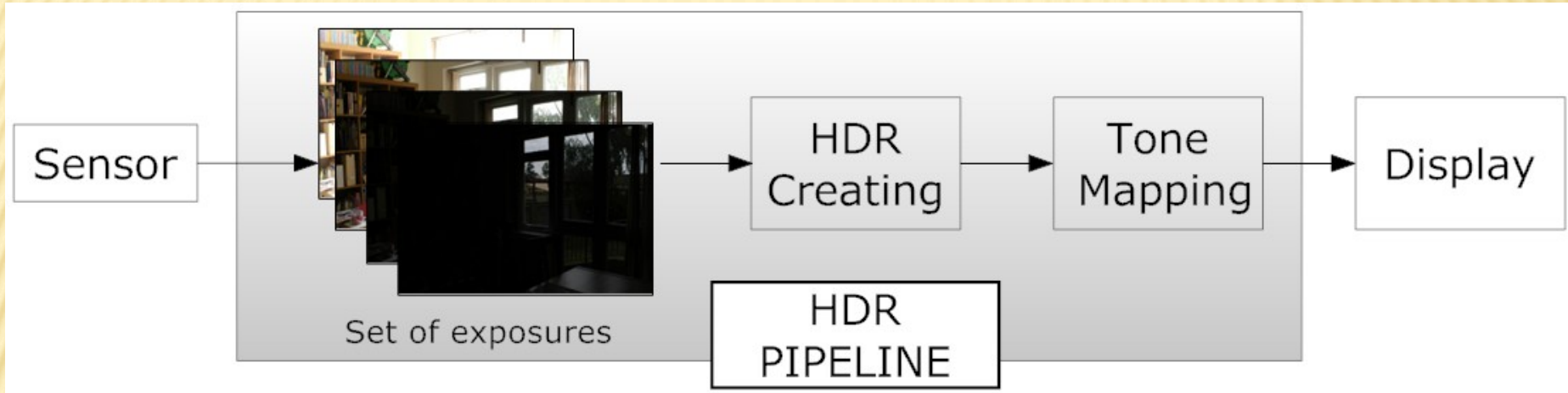

EXAMPLE of  
DISPLAYED  
RESULT



# SET OF EXPOSURES

EXP=1/125s



EXP=1/2s

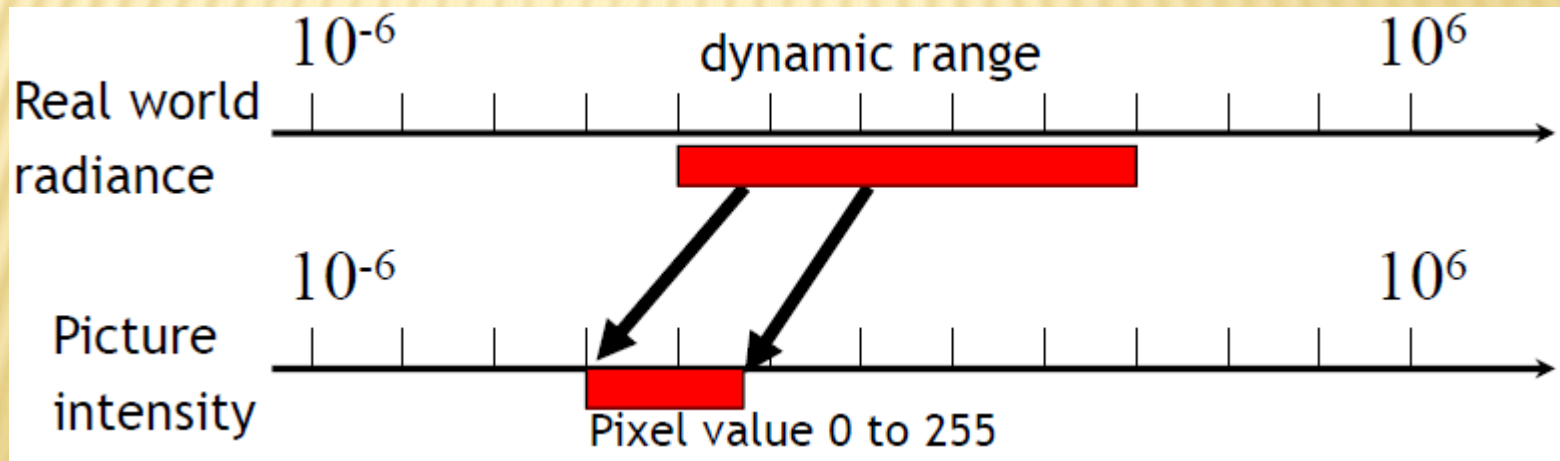

# HIGH DYNAMIC RANGE IMAGING (HDR)

## Example:

At left, an HDR image consisting of details in dark and illuminated areas

Below, the acquisitions made by a camera.

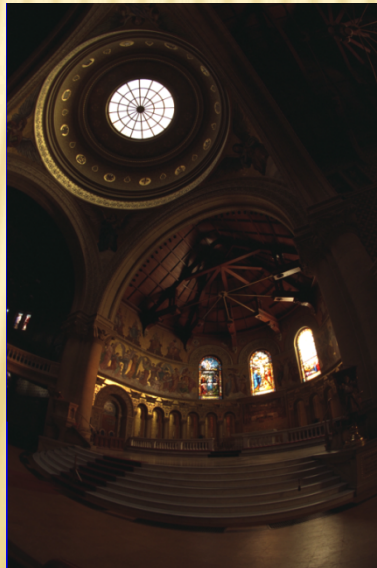



# HDR CREATING

- ▶ Paper by Debevec et. al.
- ▶ To recover dynamic range (radiance,  $E_i$ ) of the scene  $Z_{ij} = f(E_i \Delta t_j)$ 
  - ▶ To recover the response function of the imaging process

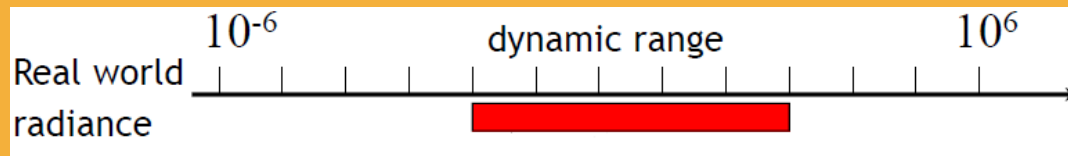

Digitization  
to obtain  $Z_{ij}$

$$Z_{ij} = f(E_i \Delta t_j)$$

$$\ln f^{-1}(Z_{ij}) = g(Z_{ij}) = \ln E_i + \ln \Delta t_j$$

$$\ln E_i = g(Z_{ij}) - \ln \Delta t_j$$

$$\ln E_i = \frac{\sum_{j=1}^P w(Z_{ij})(g(Z_{ij}) - \ln \Delta t_j)}{\sum_{j=1}^P w(Z_{ij})}$$

# tone mapping operator (TMO)

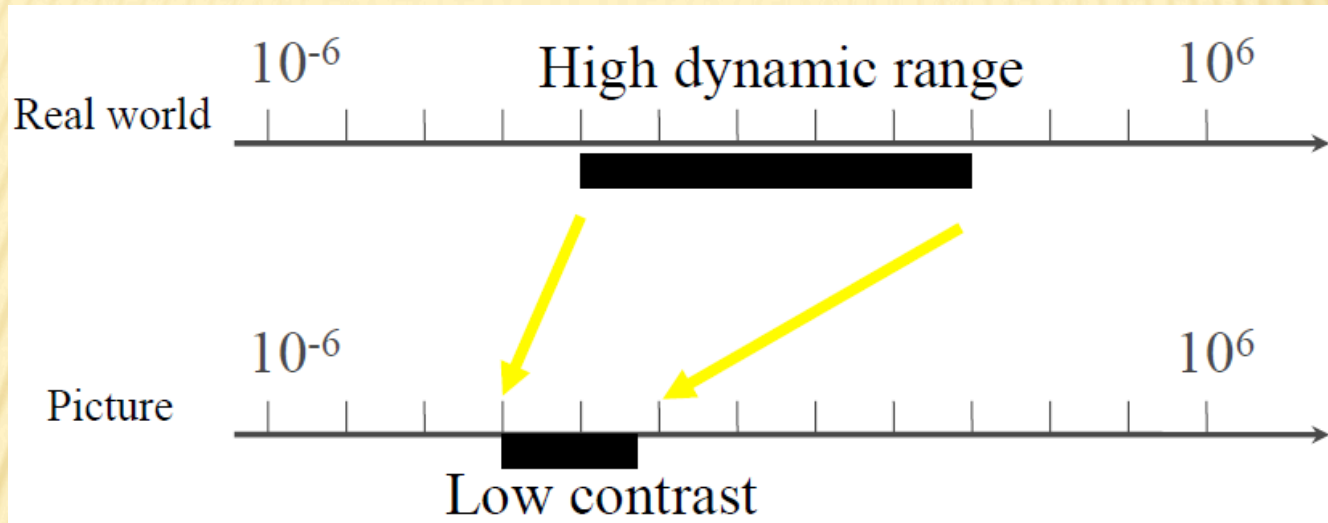

- ✘ To render the HDR data to match the dynamic of conventional hardware display
- ✘ Two types : Global and Local TMOs
- ✘ We choose a global TMO by Duan et al. to be implemented:

Displayable  
value

$$D_{ij} = C * (D_{max} - D_{min}) + D_{min}$$

$$\text{with } C = \frac{\log(E_{ij} + \tau) - \log(E_{ij(min)} + \tau)}{\log(E_{ij(max)} + \tau) - \log(E_{ij(min)} + \tau)}$$



# HARDWARE

- ✘ The prototyping platform : HDR video
- ✘ Virtex 6 FPGA development board (ml605)
- ✘ e2V LDR sensor
  - + 1.3 Megapixel at 60 fps
  - + high sensitivity, low power
  - + global shutter mode
- ✘ Several communication interfaces
  - + Ethernet
  - + DDR3 SDRAM
  - + serial interface
  - + DVI
- ✘ Design without processor

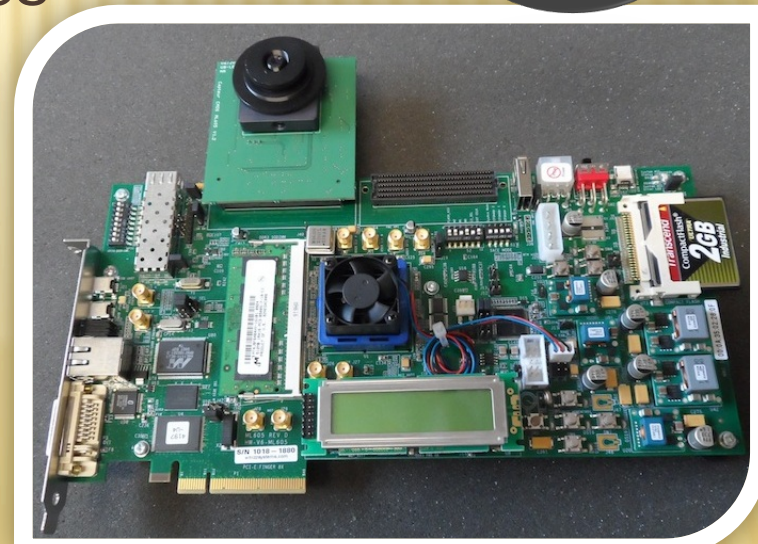

# DESIGN

- ✘ VHDL & VERILOG definition
- ✘ 3 images (low, middle and high exposures)
- ✘ Hardware modules
  - + Auto exposition control
  - + Memory management
  - + HDR+Tone mapping

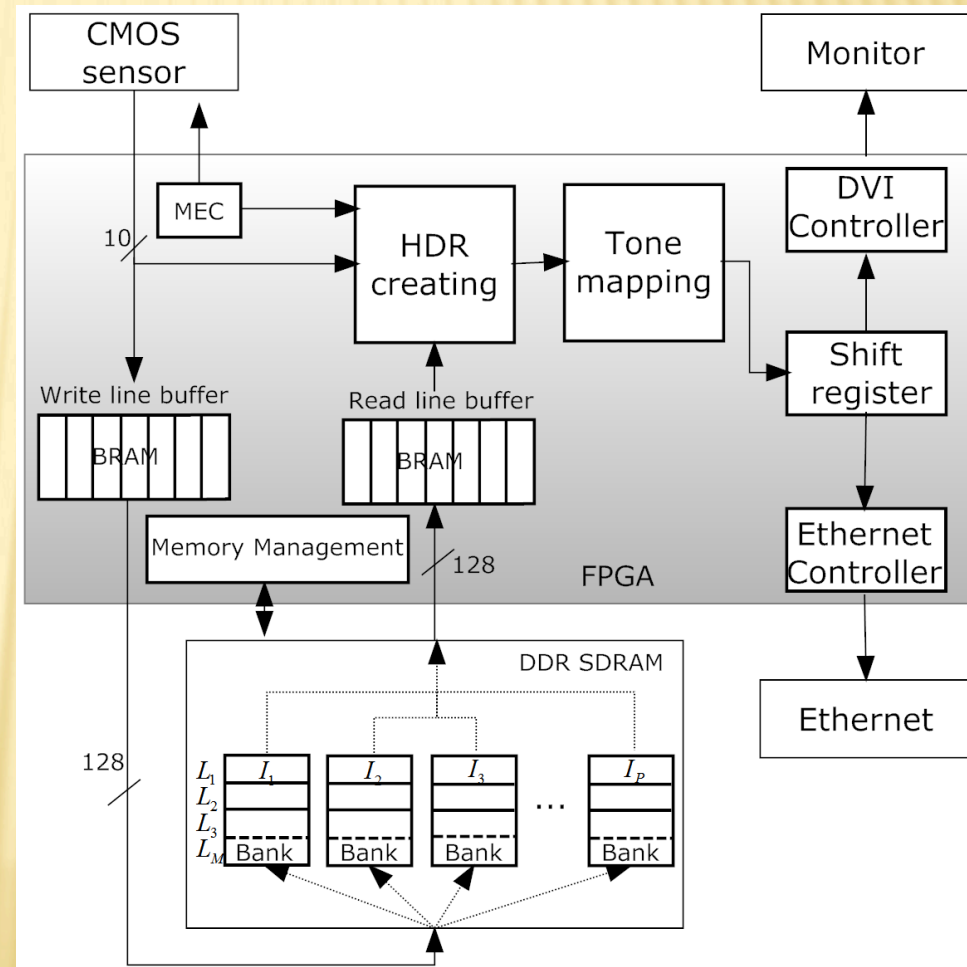



# MULTIPLE AUTO EXPOSURE CONTROL

- ✘ Adapted algorithm from Gelfand et al.
- ✘ Based on histogram calculations
  - + each of the three exposures are updated each time an image is captured by the sensor
- ✘ Exposure times choosen:
  - + For High exposure:  $\Delta t_H$ 
    - ✘ <10% of pixels are saturated in black
  - + For Low exposure  $\Delta t_L$ 
    - ✘ <10% of pixels are saturated in white
  - + For Middle exposure
    - ✘ : 
$$\Delta t_M = \sqrt{\Delta t_L \times \Delta t_H}$$

# MULTIPLE AUTO EXPOSURE CONTROL



IN REAL-TIME

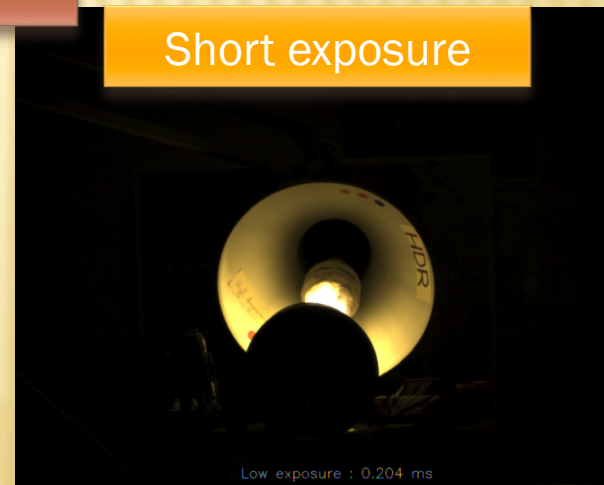
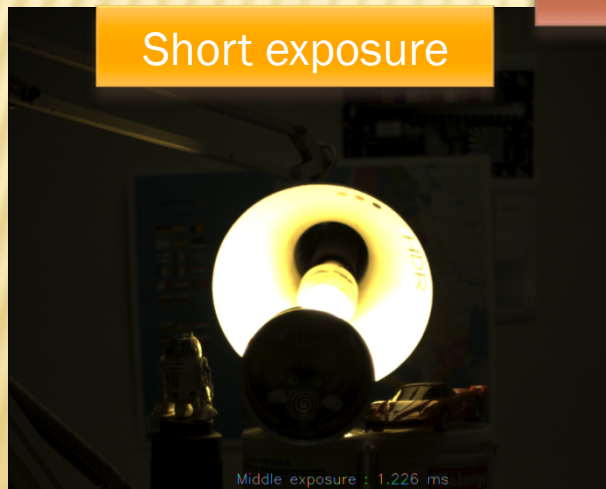











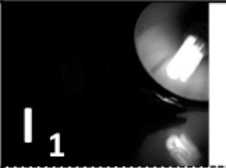
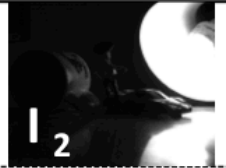

BEFORE auto exposure

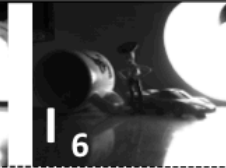
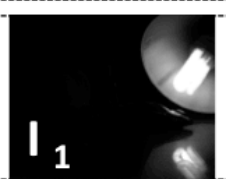
AFTER auto exposure

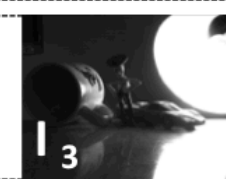
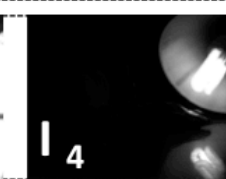
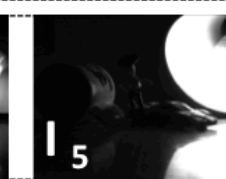
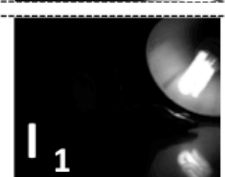
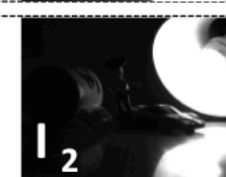
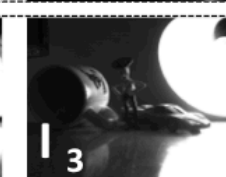
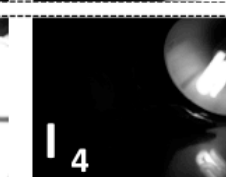

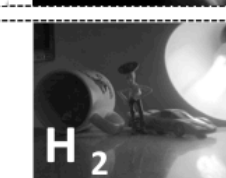
# THE SENSOR + MEMORY MANAGEMENT

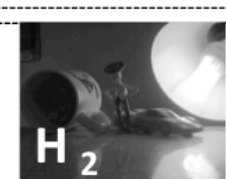
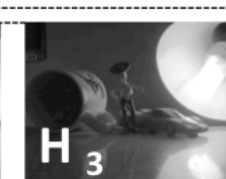
- ✘ Sends sequentially 3 exposure times (low, middle and high exposures)
- ✘ 3 video streams performed in parallel

Sensor Output						
Memory						
Memory						
Standard technique						
Our technique						

# IMPLEMENTATION

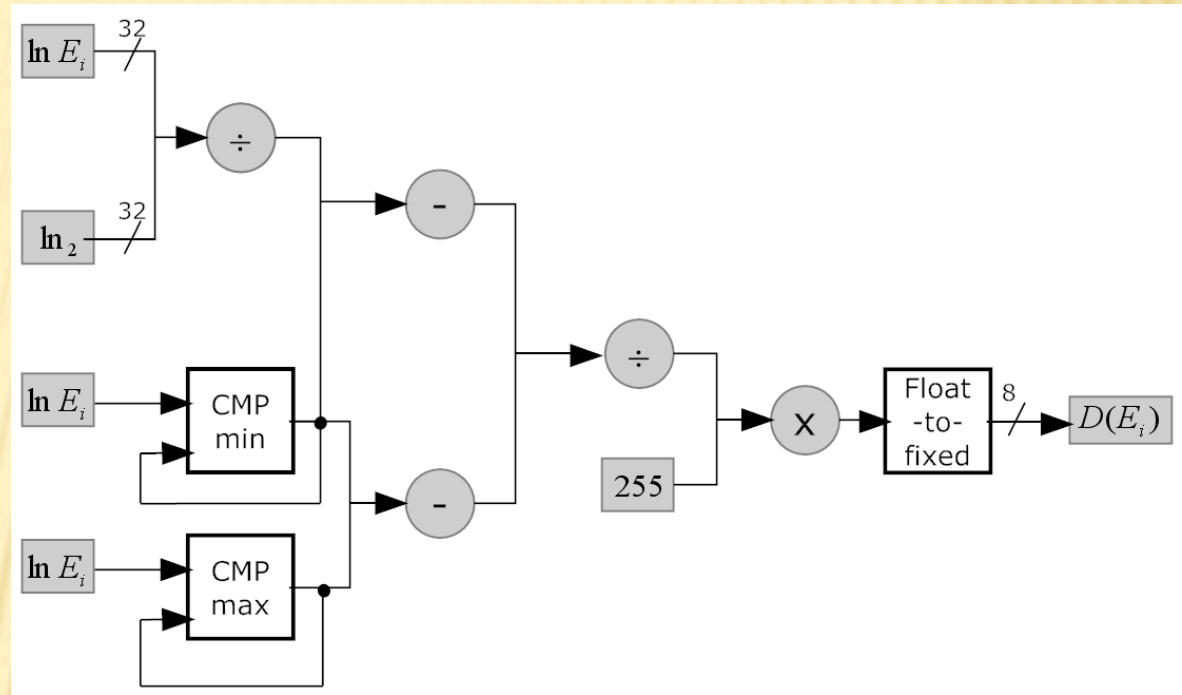
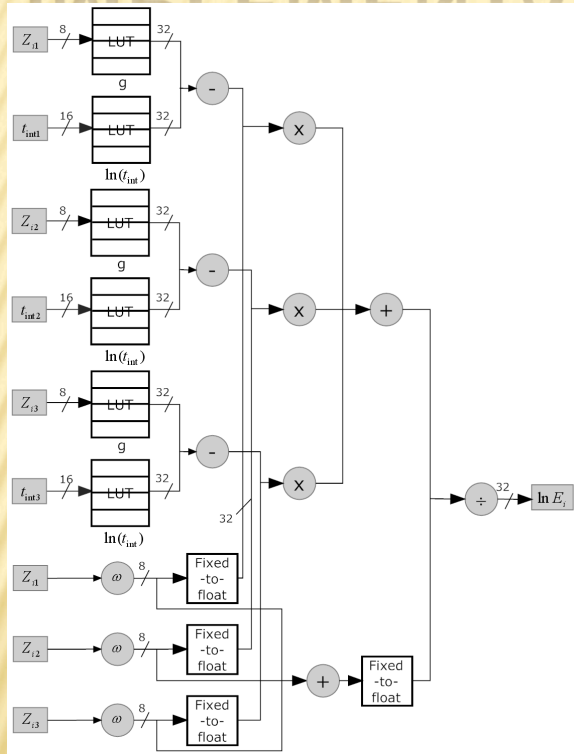

- ✘ Floating point IEEE754 implementation in VHDL
- ✘ 3 images in input



# HARDWARE SYNTHESIS AND IMPLEMENTATION

**Project Summary** x **Device** x

**Project Settings** Edit ^

Project name: project\_1  
Product family: Virtex-6  
Project part: [Virtex-6 ML605 Evaluation Platform \(xc6vlx240tff1156-1\)](#)  
Top module name: top\_test\_ezv

**Device**

✓ **Synthesis (Complete)** ^

Part: xc6vlx240tff1156-1  
Strategy: [TimingWithoutIOBPacking](#)  
Flow: [XST](#)  
Util: 14.0 %  
FMax: 167.322 MHz

**Messages**

Summary: 0 errors  
0 critical warnings  
! 4202 warnings  
Go To: [Messages](#)  
[Log](#)  
[Reports](#)

✓ **Implementation (Complete)**

Part: xc6vlx240tff1156-1  
Strategy: [MapTimingIgnoreKeepHierarchy](#)  
Flow: [ISE](#)  
Util: 12.0 %  
FMax: 122.504 MHz  
Timing Score: 0  
Unrouted: 0

**Resources**

RTL Estimation | Synthesis Estimation | Netlist Estimation | **Implemented Utilization**

Part: xc6vlx240tff1156-1

Resource	Utilization
Register	7%
LUT	12%
Slice	21%
IO	34%
Bonded IPAD	6%
Bonded OPAD	5%
RAMB36E1	2%

**Global utilization & FMax**

**Implemented Utilization**

# DEMONSTRATION

## ✘ Website: video demonstration

+ At <http://ginhac.com/research/hdr/>

Contact: [plapray@gmail.com](mailto:plapray@gmail.com)

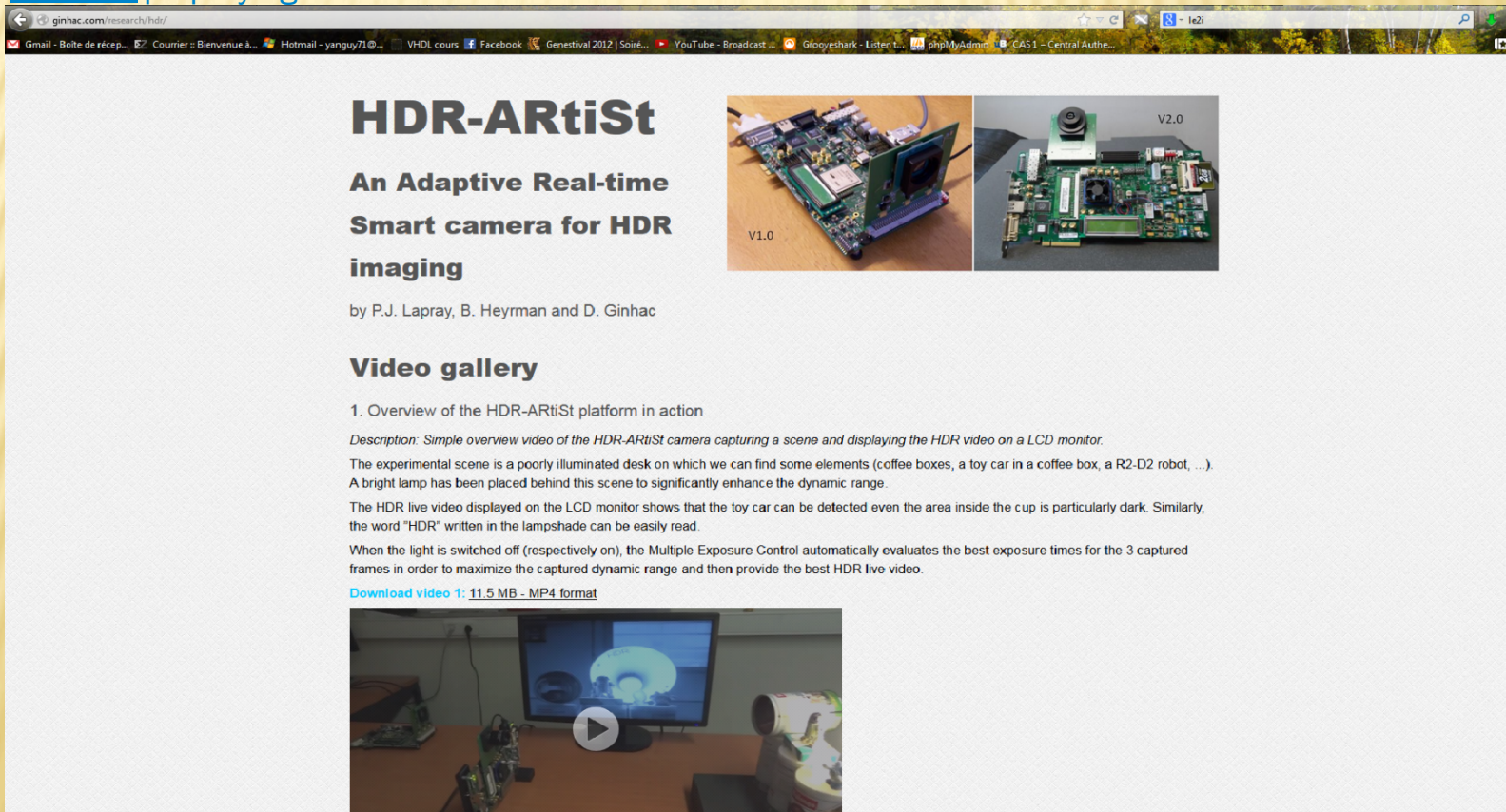

**HDR-ARTiSt**

**An Adaptive Real-time Smart camera for HDR imaging**

by P.J. Lapray, B. Heyrman and D. Ginhac

**Video gallery**

1. Overview of the HDR-ARTiSt platform in action

*Description: Simple overview video of the HDR-ARTiSt camera capturing a scene and displaying the HDR video on a LCD monitor.*

The experimental scene is a poorly illuminated desk on which we can find some elements (coffee boxes, a toy car in a coffee box, a R2-D2 robot, ...). A bright lamp has been placed behind this scene to significantly enhance the dynamic range.

The HDR live video displayed on the LCD monitor shows that the toy car can be detected even the area inside the cup is particularly dark. Similarly, the word "HDR" written in the lampshade can be easily read.

When the light is switched off (respectively on), the Multiple Exposure Control automatically evaluates the best exposure times for the 3 captured frames in order to maximize the captured dynamic range and then provide the best HDR live video.

[Download video 1: 11.5 MB - MP4 format](#)





Demonstration At <http://ginhac.com/research/hdr/>

---

## ✘ Rapid Overview of the system

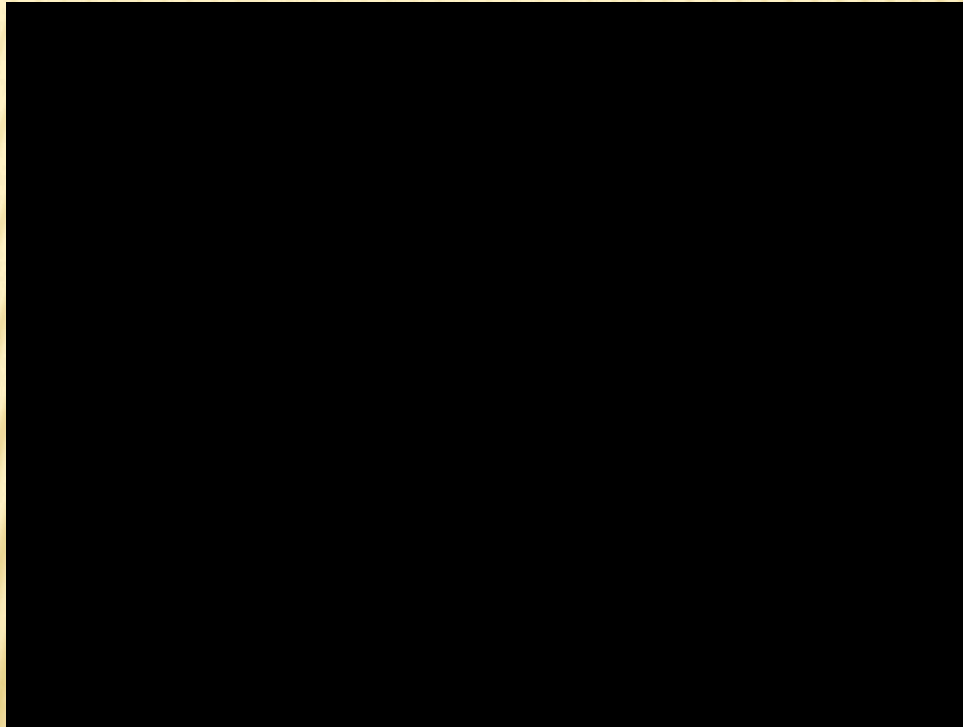

Demonstration At <http://ginhac.com/research/hdr/>

---

## ✘ 3 Live video streams

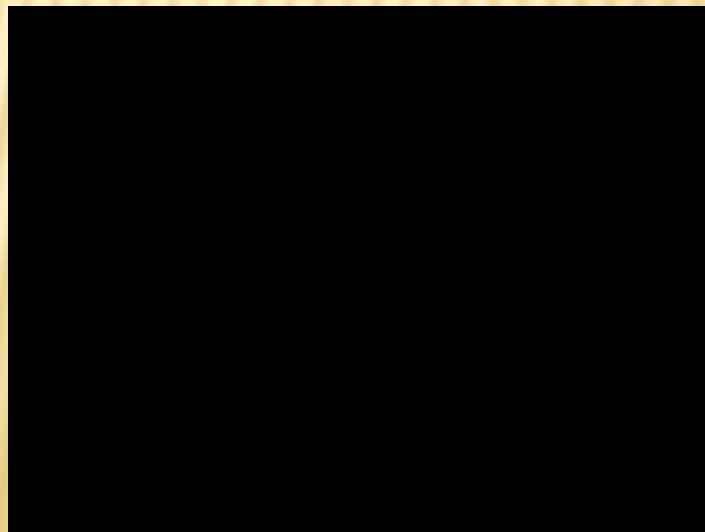



Demonstration At <http://ginhac.com/research/hdr/>

---

## ✘ Multiple Exposure Control (MEC)

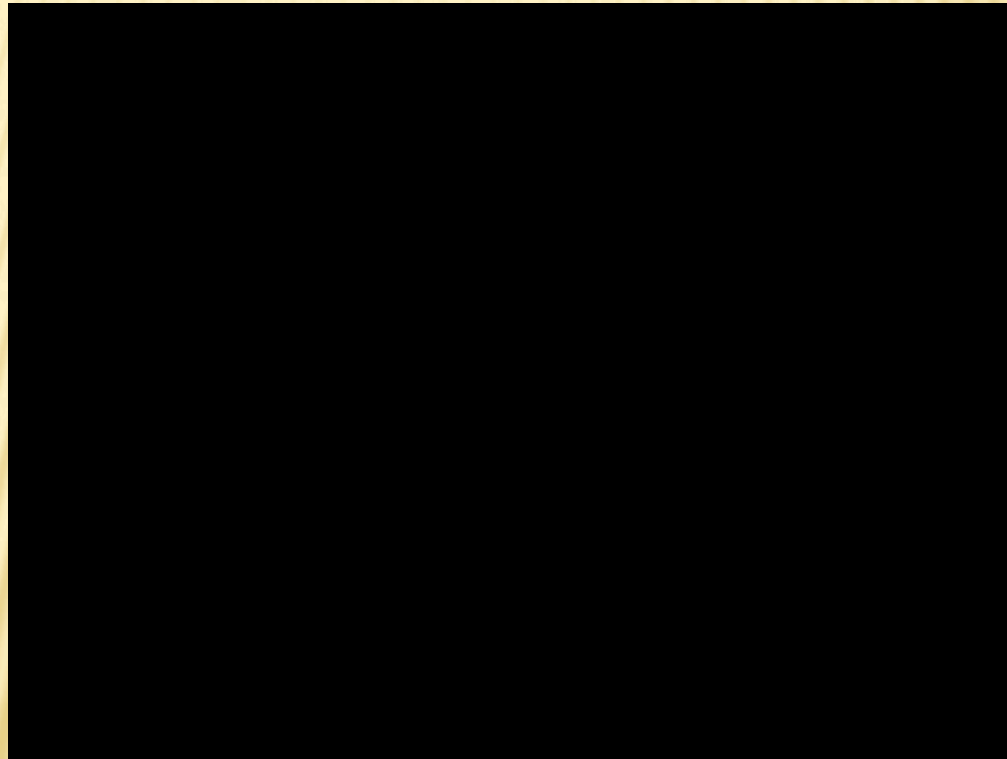

Demonstration At <http://ginhac.com/research/hdr/>

---

## × Multiple Exposure Control in detail

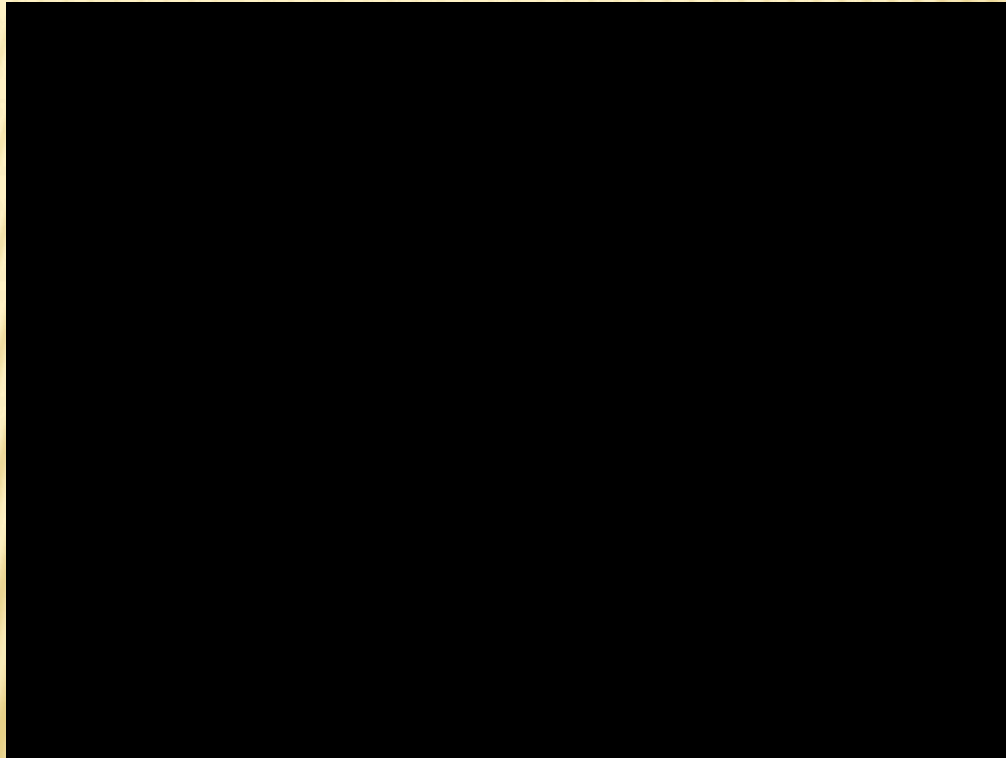



Demonstration At <http://ginhac.com/research/hdr/>

---

✘ Moving object

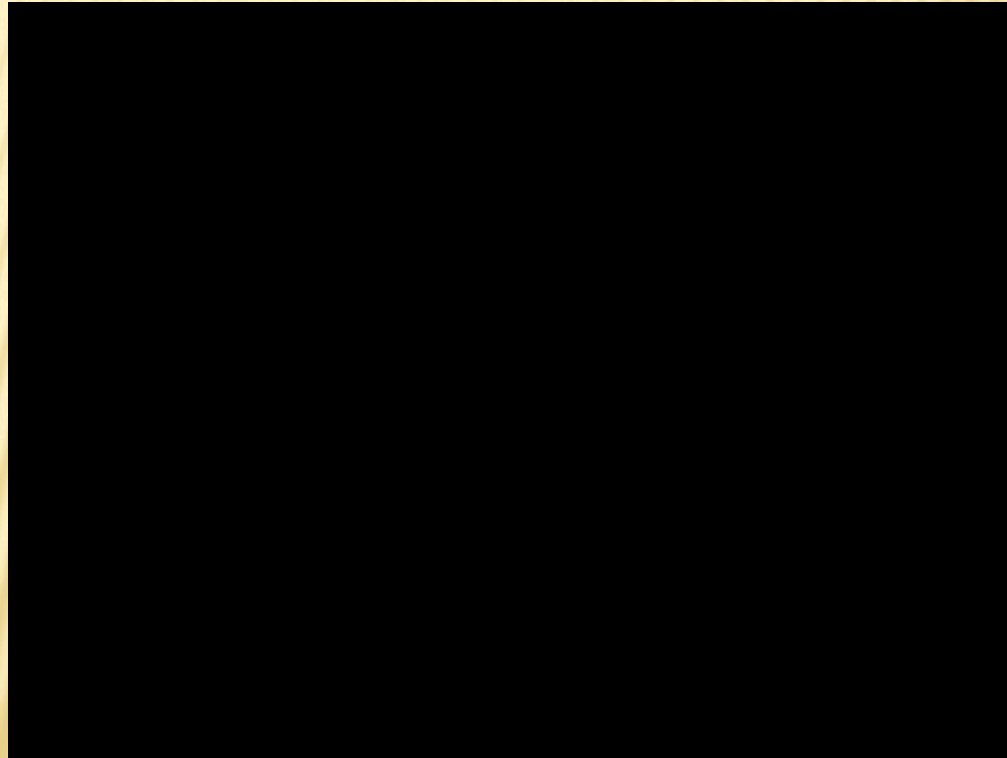

Demonstration At <http://ginhac.com/research/hdr/>

---

✘ Color implementation (in progress)

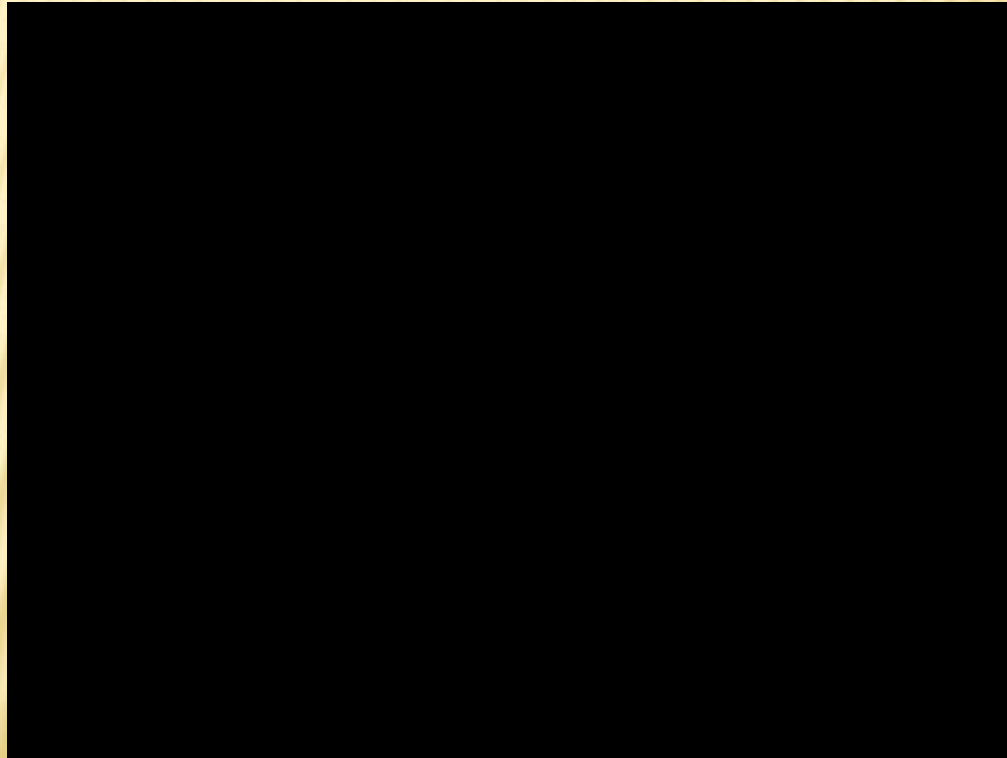



# REFERENCES

---

- ✘ Paul E. Debevec and Jitendra Malik, “Recovering high dynamic range radiance maps from photographs,” in Proc. of the 24th Annual Conference on Computer Graphics and Interactive Techniques, 1997.
- ✘ Reinhard, E., Stark, M., Shirley, P., Ferwerda, J.: Photographic tone reproduction for digital images. In: Proceedings of the 29<sup>th</sup> Annual Conference on Computer Graphics and Interactive Techniques, pp. 267–276 (2002)
- ✘ Drago, F., Myszkowski, K., Annen, T., Chiba, N.: Adaptive logarithmic mapping for displaying high contrast scenes. Computer Graphics Forum, In: 24th Annual Conference of the Eurographics Association, pp. 419–426 (2003)
- ✘ Jiang Duan, Marco Bressan, Christopher R. Dance, Guoping Qiu: Tone-mapping high dynamic range images by novel histogram adjustment. Pattern Recognition 43(5): 1847-1862 (2010)
- ✘ Z. Wang and A.C. Bovik. A universal image quality index. IEEE Signal processing Letters, vol. 9, no. 3:81-84, Mar. 2002
- ✘ Zhou Wang and Alan C. Bovik. Mean squared error: Love it or leave it? IEEE Signal Processing Magazine, 98-98-117, January 2009.
- ✘ Ureña, R., Gómez-López, J. M., Morillas, C., & Pelayo, F. (2012). Real-time tone mapping on GPU and FPGA. *EURASIP Journal on Image and Video Processing*, 2012(1), 1.
- ✘ Guthier, B., Kopf, S., & Effelsberg, W. (2012, July). Optimal shutter speed sequences for real-time HDR video. In *Imaging Systems and Techniques (IST), 2012 IEEE International Conference on* (pp. 303-308). IEEE.

THE END

---

Gracias  
MERCİ  
ARIGATO  
*thank you*