



HAL
open science

Towards a distributed framework for transportation planning: A food supply chain case study

Muhammad Ali Memon, Bernard Archimède

► To cite this version:

Muhammad Ali Memon, Bernard Archimède. Towards a distributed framework for transportation planning: A food supply chain case study. IEEE International Conference on Networking, Sensing and Control, Apr 2013, Paris-Evry, France. pp. 603-608. hal-00932429

HAL Id: hal-00932429

<https://hal.science/hal-00932429>

Submitted on 17 Jan 2014

HAL is a multi-disciplinary open access archive for the deposit and dissemination of scientific research documents, whether they are published or not. The documents may come from teaching and research institutions in France or abroad, or from public or private research centers.

L'archive ouverte pluridisciplinaire **HAL**, est destinée au dépôt et à la diffusion de documents scientifiques de niveau recherche, publiés ou non, émanant des établissements d'enseignement et de recherche français ou étrangers, des laboratoires publics ou privés.



Open Archive Toulouse Archive Ouverte (OATAO)

OATAO is an open access repository that collects the work of Toulouse researchers and makes it freely available over the web where possible.

This is an author-deposited version published in: <http://oatao.univ-toulouse.fr/>
Eprints ID: 10584

To cite this version:

Memon, Muhammad Ali and Archimede, Bernard *Towards a distributed framework for transportation planning: A food supply chain case study.* (2013) In: IEEE International Conference on Networking, Sensing and Control , 10 April 2013 - 12 April 2013 (Paris-Evry, France).

Any correspondence concerning this service should be sent to the repository administrator: staff-oatao@listes-diff.inp-toulouse.fr

Towards a Distributed Framework for Transportation Planning: A Food Supply Chain Case Study

Muhammad Ali Memon

University of Toulouse, INP-ENIT
47 Avenue d'Azereix
BP1629, F-65016 Tarbes Cedex, France,
Email: Muhammad-Ali.Memon@enit.fr

Bernard Archimede

University of Toulouse, INP-ENIT
47 Avenue d'Azereix
BP1629, F-65016 Tarbes Cedex, France,
Email: Bernard.Archimede@enit.fr

Abstract—Distribution and remoteness of production sites of enterprise networks, remoteness and multiplicity of distribution centers, the explosion of e-commerce has led to an increase in the number of requests for transportation around the world. This increase in the volume of transport of goods and cargo added to the growing number of passenger trips has led to an increase in transportation means (cars, planes, boats, etc.), with a consequent increase in the capacity of communication channels, which reached saturation (highways, airlines, shipping lanes), an expansion of storage areas (ports, airports, warehouses, etc.), and an increase in pollution impacting the environment sustainability. In this context, organization, management and transportation planning, become crucial, favored the emergence of many specialized companies (3PL) offering a pooling of transport and centralized management. The objective of this paper is to present a distributed architecture planning of transportation activities aimed at better utilize transport resources by grouping several orders of transport for each effective displacement.

Keywords: *Distributed Scheduling; Multi-Agent Systems; Collaborative Transportation Planning; Third Party Logistics.*

I. INTRODUCTION

The globalization of markets and the search of profit opportunities have led to the relocation of manufacturing firms in emerging countries for finding low-cost labor for work. Production is nowadays distributed over several manufacturing sites that are often at very distant distribution centers. The business is growing constantly and is not any longer limited to geographical boundaries. All this leads to an increase in the number and frequency of transport in the world and in the average length of traveling trips. Transportation costs are increasing due to the steady increase in oil prices. These costs have become a major concern for the industries, because it increases the cost of the raw materials that they procure as well as the distribution of products to consumers. The impact of transportation costs on products don't permit usually those companies which want to reach faraway clients and manage their own resources (vehicles, ships, aircraft, etc..) to transport their goods.

The effort to reduce the cost of transportation has encouraged the emergence of new third-party enterprises specializing in logistics and transport, commonly known as 3PLE (Third Part Logistics Enterprise)[5]. These 3PLEs mutualize the exploitation, warehousing and transportation resources between several companies. They take charge of whole process of trans-

portation from loading products since suppliers' warehouses to the distribution of goods to customers.

The increase in number of transportation orders, diversity of clients due to different kind of business activities, distance from production companies and distribution sites, the size of the transport network make it even very complicated for 3PLE to manage transportation planning. To fulfill customers demands and improve the performance of supply chains, it must manage its own resources and often collaborate with other companies 2PLE (carriers) and 3PLE.

The work presented in this paper focuses on planning transport activities by a 3PL enterprise in distributed manner resulting from transport requests from several customers. The objective is to evaluate the ability of the generic model of planning SCEP (Supervisor, Customer, Environment, and Producer) for transportation planning process. After a state of the art on the latest research on transportation planning, we describe the generic SCEP and its limits for the planning of transportation activities. We present here the new T-SCEP model and illustrate its application with a case study. Finally, we conclude with the future perspectives.

II. RELATED WORKS

Several approaches have been proposed to solve transportation planning problem. J. Sauer et al[7] proposed a centralized approach with a global scheduler, which schedules transportation planning activities. They model the problem by a 5-tuple(R, P, O, HC, SC), where R denotes the set of required resources, P the set of products, O the set of actual orders, and HC and SC the sets of hard and soft constraints, respectively. They use a rule-based approach and heuristics to produce several scheduling strategies. This approach is centralized and is limited to the planning of transportation activities of a single enterprise. Today, the enormous size of the transport networks requires, to realize the plan with collaboration of many transportation enterprises. These enterprises most often, wish to keep certain confidentiality of their organization, their models, their methods and their data. The need for confidentiality limits the scope of centralized approaches. A.Baykasoglu et al [2] proposed a multi-agent approach to address collaborative transportation problem. This approach is based on cooperation between transport-order agents and

truck agents, which propose grouping multiple orders together in a vehicle. Agents communicate with each other in order to choose the best economical way to transport the order. In this approach, transport order agent is bound to accept the proposition from one truck agent, which provide a nonstop delivery from origin to destination. However, in reality considering enormous size of the transport network, a truck rarely alone transports a transport order. A transport order requires, most often, several trucks.

R.Sprenger et al[9] proposed a multi-agent system for cooperative transportation planning. The system decomposes the overall transportation problem into sub problems and solve those sub problems on autonomous basis with Ant colony Optimization approach. This work neither explains suitably decomposition methodology and nor decomposition's effect on overall transportation problem. Additionally it does not consider privacy issues between manufacturers and they don't take into account multiple orders together while sharing vehicles. S. Zegordi and al [12] study integrating transportation and production scheduling by considering multiple sourcing in a two-stage supply chain scheduling problem. In which the first stage is composed of multiple suppliers distributed over various geographic zones. In the second stage, vehicles transport jobs from suppliers to a manufacturing company. This transportation scheduling is based on genetic algorithm. Manufacturing company splits the order between multiple suppliers according to quota. Then, each supplier transports its quota of raw material to the single manufacturing company, which achieves an assembling of all the received raw materials. Suppliers located in the same geographical zone could transport their raw material to the manufacturing company by sharing vehicles. This approach is a centralized approach which will face the confidentiality issue. Additionally, due to critical economic conditions, this is not acceptable that vehicles return empty to suppliers that is resulted from this method.

In further studies, a simulation framework is presented in[8] for assessing the performance of cooperative transportation planning and isolated transportation planning. Groupage systems[3] are introduced, which are defined as logistics inter-organization systems that interchange required information and manages capacity balances between different independent transporters. M.Mes et al [6] study the interaction between intelligent agent strategies for real-time transportation planning. A multi-agent theoretical approach on dynamic transportation planning is given in [4]. D.Yazan et al [11] examines the environmental impact of transportation and how it can be altered by showing current and reengineered supply chain through a case study.

III. SCEP MULTI-AGENT MODEL

A. Description of model

The SCEP multi-agent model (Figure. 1) is briefly a model developed for all types of planning activities[1], [10], which introduces an indirect cooperation between two communities of agents (customer agents called C and producer agents called P), leading to a high level of co-operation. Each customer

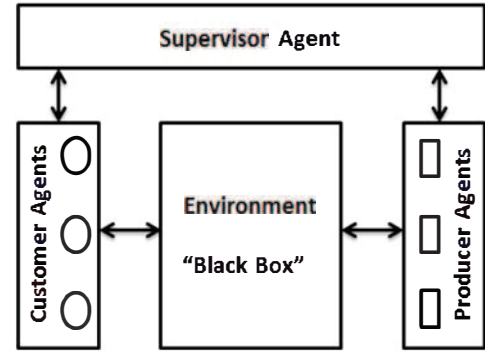

Fig. 1. SCEP model

agent manages one order from the customers; each producer agent manages one resource (machine, raw material or human) of the organization. The cooperation between customer agents and producer agents is performed synchronically through the background environment agent E. All the activities are controlled by the supervisor agent S. The detail working, procedures and dynamic of the model will be introduced in next section.

B. Dynamic of model

Each object in the environment is associated with one operation to be achieved in one customer order. The set of objects are related to the routing followed by the intervention domain of concerned agents. In perfect correlation with the model definition, each operation only concerns one customer agent. But some objects can belong to the intervention domains of several producer agents, because multi machines may achieve the same activity. The position format of object O is [(S, F), N], where (S, F) represents a continuous temporal interval between a starting date S and a final date F, and N represents the name of resource executing object O. Each object has four positions, wished position (WP), effective position (EP), potential position (PP), and confirmed position (CP). The WP is the position requested by the customer. The EP results from the scheduling of all the tasks associated with the propositions collected from the environment. The PP results from the scheduling of one task associated with a proposition collected from the environment. The CP is the final position after all the scheduling process.

The supervisor agent provides functions of creating the agent society, generating the inside objects and initializing the environment. Then, the supervisor agent triggers the cycle of cooperation process by activating the customer agents and telling the producer agents to wait. The customer agents firstly ask for EP and PP of the associated objects from the environment. The environment sends the results back, of course the result is null in the first cycle. The customer agents schedule the operations which have not been validated, and influence the associated objects by alternative WP. If the WP of one object is the same as the EP and PP, customer agents will make the confirmation. At last, the customer agents send CP and WP of the associated objects to the environment. Each customer agent

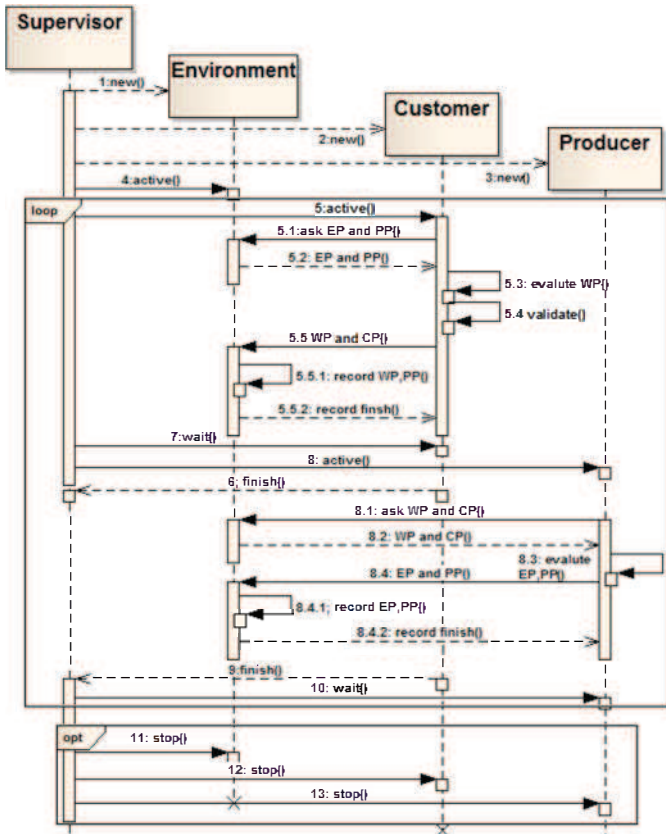

Fig. 2. Sequence diagram of SCEP model

performs its actions simultaneously but remains independently from others. It will inform the supervisor agent once its actions are finished.

Once the end of the action from the last customer agent has been recorded by the environment, the supervisor agent activates the producer agents and sends the wait signal to the customer agents. The producer agents firstly ask for the CP and WP of the objects belonging to its intervention domain from the environment. The environment sends the results back; the producer agents record the CP and schedule the tasks which are not definitely positioned. They influence these objects by alternative EP and PP to the environment. Each producer agent performs its actions independently and informs the supervisor agent as soon as its activities finished. When the end of the action from the last producer agent is recorded, the supervisor agent finishes the first cycle of the cooperation and starts the next cycle immediately. In each cycle (except the first one), at least one object should be confirmed to avoid the deadlock problem (Figure. 2).

The alternation cycle between the activation of customer agents and producer agents will repeated until the CP of all the environmental objects is fixed. When entire objects are confirmed, there are no WP from customer agents anymore. The alternative (opt) area will be executed and the supervisor agent will terminate the environment, customer and producer agents. The whole scheduling process is finished.

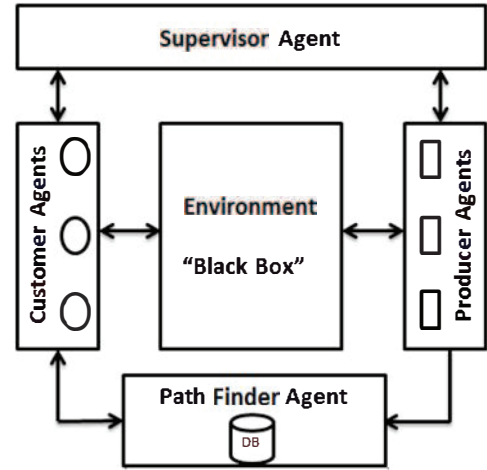

Fig. 3. T-SCEP model

The SCEP model has been used with success for production and maintenance scheduling. The use of model SCEP for transportation planning requires naturally association of transportation orders with customer agents and vehicles with producer agents. Transport activities are associated to elementary travellings achieved by vehicles. A transport activity is a non-stop travel from the loading location to the unloading location. However, transportation planning needs the definition of all sequential activities necessary between origin and destination for each transport order. This set of sequential activities is important for each customer agent for evaluating the predicted route to go from origin to destination. Additionally vehicles require most often the grouping of multiple orders according to their maximum loading capacity, while producer agents of SCEP model only execute one task at a time. For these reasons the SCEP model must be evolved.

C. T-SCEP Model

In order to take into account the problem stated in previous section, we propose T-SCEP model as shown in Figure. 3. In this model we added a 'Path Finder Agent' and introduced a rule for grouping transport orders at producer agents side. Each time when the planning process starts, Path Finder updates E3PL vehicles and their activities information in order to provide up to date best path to customer order agents. Based on transportation network information graph and 3PLE vehicle activities between cities stored in its database, Path Finder agent elaborate for the managed transport order the traveling route between pickup and delivery locations. This route is a sub-graph of the overall transportation network graph, where each arc corresponds to an activity achieved by 3PLE vehicle. Before starting the scheduling process, all customer orders are invited by the supervisor to contact the Path Finder in order to obtain their possible travelling routes from their own pickup to delivery locations. After this the scheduling process is achieved by the basic SCEP scheduling techniques described in previous section. At each cycle, the choice of the best path in the sub-graph is achieved by customer order agents

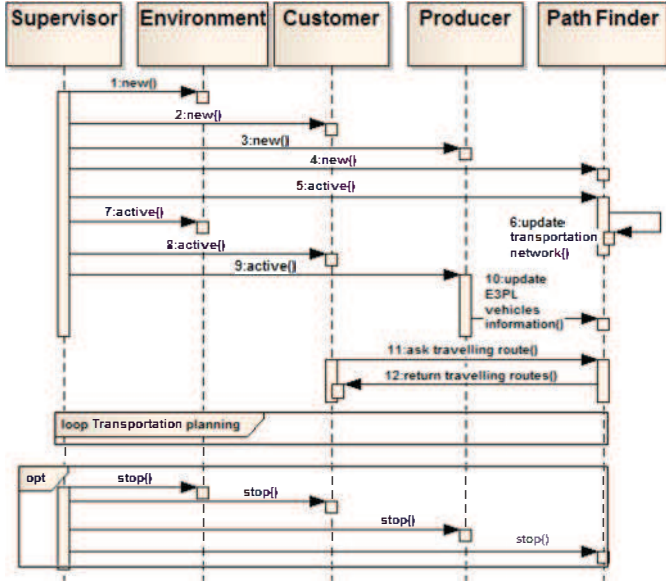

Fig. 4. Sequence diagram of T-SCEP model

regarding the criteria which may be shortest distance, earliest delivery or minimum cost to reach the delivery location. At each cycle the producer (vehicle) agents group the transportation tasks regarding their pickup time, associated quantity and achieve a plan based on Vehicle Routing Algorithm. Nevertheless these algorithms may introduce several empty travels. Figure. 4 illustrate the sequence diagram of T-SCEP model. Transportation Planning loop in the diagram is same as loop in the basic SCEP model(Figure. 2).

IV. APPLICATION ON T-SCEP MODEL

A. Case Study Description

We consider a simple case study of transporting dairy products from suppliers to supermarkets. We name this case study "Food Supply Case Study" (FSCS). A 3PLE is responsible to transport those dairy products. 3PLE transportation network is located in the south region of the France. The network comprises of eight sites Tarbes(TA), Pau(PA), Dax(DA), Auch(AU), Toulouse(TO), Montauban (MO), Marmande(MA)and Bordeaux(BO)(Figure. 5). From which two are Supplier sites(TA,BO represented by rectangles), three are Intermediate Distribution Centers(DA,AU,MO represented by triangles) and all of the eight sites are customers(represented by circles). Supplier at TA produces two products (P1:Yogurt and P2:Cheese). Supplier at BO also produces two products (P3:Milk and P4:Cream). All of these four products need to be delivered at each customer site. 3PLE uses these Intermediate distribution centers(IDCs) for transit purpose, to provide the facility to store the products on temporary basis. They are equipped with refrigeration facility and stock the products until they are picked by vehicles for delivery to another IDC or to supermarkets. 3PLE manages its own fleet of 7 transportation vehicles (V1,V2,V3,V4,V5,V6,V7), which are assigned default Start Locations(Loc), Avail(Availability Time

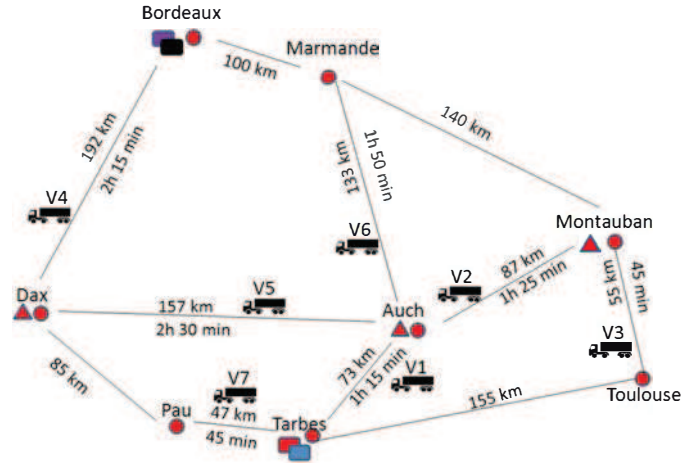

Fig. 5. Food Supply Case Study (FSCS)

TABLE I
3PL VEHICLES AND ACTIVITIES

Resource	Loc	Capacity	Avail	MWT	Rule	Activity
V1	Tarbes	200	7h	1h	FIFO-CUMUL	TarbesAuch
						AuchTarbes
V2	Auch	100	16:30h	1h	FIFO-CUMUL	AuchMontauban
						MontaubanAuch
V3	Montauban	100	19h	1h	FIFO-CUMUL	MontaubanToulouse
						ToulouseMontauban
V4	Bordeaux	200	7h	1h	FIFO, CUMUL	BordeauxDax
						DaxBordeaux
V5	Auch	150	13h	1h	FIFO, COMUL	AuchDax
						DaxAuch
V6	Auch	50	16:30h	1h	FIFO, CUMUL	AuchMarmande
						MarmandeAuch
V7	Pau	100	5h	1h	FIFO-CUMUL	PauTarbes
						TarbesPau

at Loc) and MWT(maximum waiting time for an order when it is taken into account by the vehicle) by its management. The activities represent a direct nonstop travel from origin to destination. For example, a direct travel from Tarbes to Auch is an activity TarbesAuch, which is performed by V1 as shown in Table I. A return travel from Auch to Tarbes is another activity AuchTarbes that is also performed by the same resource V1. Each vehicle follows the rule "FIFO-CUMUL". FIFO represents traditional "First in First Out" data structure, means vehicle will serve transport orders on FIFO basis. CUMUL represents cumulative, means vehicle can group more than one orders for delivery depending on its maximum capacity. Vehicles are also equipped with refrigeration facility. They charge different price for transportation, which is pre-negotiated between suppliers and 3PLE management.

Each vehicle has different load capacity. In FSCS we consider a standardized box for packaging, for which we undertake following assumptions.

Assumption 1: A box of same volume, dimension and size is used for all kinds of products. After packaging, box has the same weight for all products

Assumption 2: For all boxes, number of products is constant. However quantity that box can contain for each product

TABLE II
ESTIMATED DISTANCE AND TIME BETWEEN SITES OF TRANSPORTATION NETWORK

Sites	BO	MA	DA	AU	TA	PA	MO	TO
BO	-	-	192km (2h30)	-	-	-	-	-
MA	100km	-	-	133km (2h)	-	-	-	-
DA	192km (2h30)	-	-	157km (2h30)	-	-	-	-
AU	-	133km (2h)	192km (2h30)	-	73km (1h30)	-	87km (1h30)	-
TA	-	-	-	73km (1h30)	-	47km (1h)	-	-
PA	-	-	-	-	47(1h)	-	-	-
MO	-	-	-	73km (1h30)	-	-	-	45km (1h)
TO	-	-	-	-	-	-	45km (1h)	-

depend on the kind of product and, not on the box

Assumption 3: The number of boxes in a vehicle is always an integer constant.

Usually, in a 3PL enterprise, vehicles visit several sites. If the number of sites is superior to 2, the number of activities depends on the network organization. In our example, we assume that the number of sites visited by each vehicle is equal to 2. It means that each vehicle is reserved to perform two activities. Let us notice A and B the two sites and t_{AB} and t_{BA} the two activities. When a vehicle is at site A, t_{AB} is the next activity and t_{BA} is the return activity. When a vehicle is at site B, t_{BA} is the next activity and t_{AB} is the return activity.

For the Transportation network estimated distance and time between two sites are specified in the Table II. Transportation time between two sites may variate depending on several conditions. If D_{AB} represents transportation duration from site A to site B and D_{BA} from site B to site A, then $D_{AB} \neq D_{BA}$

- 1) If vehicle is loaded when going from A to B and is empty when coming back from B to A or vice versa. Loaded vehicle will take more time to travel than when it is empty.
- 2) If vehicle is fully loaded when going from A to B and it is partially loaded when coming back from B to A or vice versa. Fully Loaded vehicle will move slower than when it is partially loaded.
- 3) If vehicle drive through a route which is inclined, so going upwards to the route is slower than coming downwards from the same route.
- 4) If there might be disturbances of traffic jam or vehicle broken or bad weather in either of the direction of going to A from B or coming back to B from A.

In the context of this paper, we don't consider above time variation conditions. We use the same estimated time for going from site A to B and vice versa. In order to keep this case study simple, we consider that loading and unloading time of products to IDCs and supermarkets is included in traveling

duration.

B. Illustrative example

In our case study, we take a wallet of 4 Transportation Orders(TO) as shown in Table III. TO arrives in the system as 9-tuple(O,P, PL, DL, PT, DT, PD, DD, and PQ) of attributes. Where O is Objective(Less costly, early delivery), P is Product ID, PL stands for Pickup Location of supplier from where vehicle loads the product packages. DL represents Delivery Location of customer where order should be delivered. PD and PT stands for Pickup Date and Pickup Time. On this date and time, TO is ready for loading at supplier's warehouses. Similarly DD and DT are Delivery date and Delivery time. DD and DT are the latest date and time on which TO should be delivered at customer site. Finally PQ is the Product Quantity(number of boxes).

Path Finder Agent receives input PL and DL of an TO and elaborate the elementary traveling activities(sub-graph). Table IV describes the precise routing used by TO proposed by Path Finder Agent. For each step of the travel, task number, associated activity, color and estimated duration are given. (taken from Table II). Different color is assigned to each activity for illustration purpose to distinguish similar activities. Same color represents that two orders have two similar tasks that belong to a same activity, which can be regrouped and performed by the resource(s) together at the same time. For example first task of TO1 and TO2 belongs to same activity "TarbesAuch". These two tasks can be performed at the same time by the same resource.

Customer agents realize an infinite capacity planning for all tasks of their transport orders (TO1, TO2, TO3 and TO4) as shown in Figure. 6, and generate for them the wished position (see section 3 for detail). After, the wished positions are sent to environment. Taking into account their published basic activities, each producer agent perceives the different tasks to schedule. Then, producer agents realize simultaneously a finite capacity planning for all the perceived tasks considering vehicles capacity and maximum waiting time duration for a transport order. For this, firstly producer agent sorts the perceived tasks according to the corresponding activity. Tasks associated to the same activity are arranged in FIFO order taking into account the ascending pickup date. Secondly, producer agent groups the different tasks of an activity according to the maximum waiting time duration and the capacity of its associated vehicle.

If associated vehicle's current standing position is at the beginning of the next activity then vehicle executes the activity for this group of tasks. If associated vehicle is not present at the next activity but it is at the beginning of another return activity, then producer agent first executes displacement from return activity and then generates the transportation plan for that next activity. Tasks that could not become part of the group in first place due to vehicle's finite capacity limitation are planned later on its return to the same activity. Tasks which are planned later may arrive late at their delivery location.

TABLE III
TRANSPORTATION ORDERS

NO	O	P	PL	DL	PD	PT	DD	DT	PQ
1	Less Costly	P1	TA	MA	1/1/13	6h	1/1/13	19h	50
2	Early	P2	TA	TO	1/1/13	7h	1/1/13	20h	50
3	Less Costly	P3	BO	MA	1/1/13	6h	1/1/13	19h	50
4	Early	P4	BO	TO	1/1/13	7h30	1/1/13	20h	50

TABLE IV
ROUTING

TO	Routing	Task	Activity	color	Time
1	1	1	TarbesAuch	Red	1h30
		2	AuchMarmande	Green	2h
2	2	1	TarbesAuch	Red	1h30
		2	AuchMontauban	Yellow	1h30
		3	MontaubanToulouse	Blue	1h
3	3	1	BordeauxDax	Cyan	2h30
		2	DaxAuch	Black	2h30
		3	AuchMarmande	Green	2h
4	4	1	BordeauxDax	Cyan	2h30
		2	DaxAuch	Black	2h30
		3	AuchMontauban	Yellow	1h30
		3	MontaubanToulouse	Blue	1h

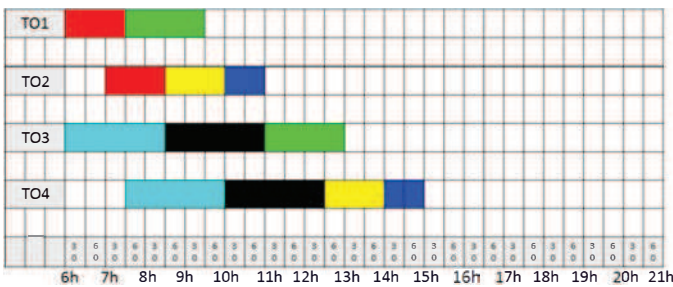

Fig. 6. Wish position for all sequential tasks of Transport Orders

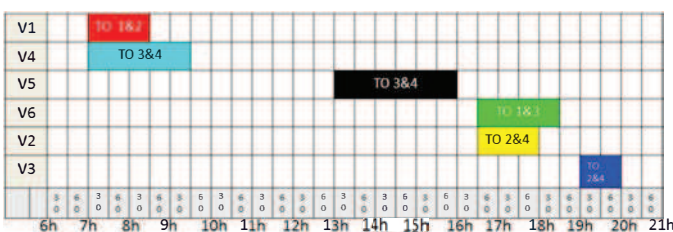

Fig. 7. Grouped planification of Transport Orders

After all the planning process is finished, we can see the gantt result of all four TOs in Figure. 7 computed by T-SCEP.

V. CONCLUSION AND FUTURE WORK

In this paper we discussed a collaborative transportation planning problem and to solve that, proposed a distributed multi-agent framework called "T-SCEP". Cooperation between two communities of agents (customer agents and producer agents). Customer agents offer transport jobs through sequential auctions and vehicle agents compete with each other to serve those jobs. In T-SCEP, we extend SCEP model:

firstly with a Path Finder Agent elaborates, when solicited for each order the traveling routes between pickup and delivery locations. Secondly with a rule for grouping transport orders at producer agents side. There are several directions for future research. Instead of one 3PL, multiple 3PL enterprises can collaborate with each other to deliver the orders and how these 3PLE(s) will collaborate with each other needs to be investigated. Other parameters like size, type and weight of the products have to be considered and how much they effect the overall planning process. Agility is a very important factor in such kind of dynamic systems that need to be addressed effectively. Issues like traffic delays, vehicle breakdown and penalties have to be researched. To keep the case study simple and to facilitate the method understanding, we restricted the number of sites visited by a vehicle to two. The taking into account of more than two sites is also one of our future study.

ACKNOWLEDGEMENT

The research work presented in this paper has been achieved in the framework of TECCAS project. The aim of this project is to develop technologies in order to promote collaboration between the actors of food supply chains. This project is funded by the European program POCTEFA which is at service of the pyrenean area.

REFERENCES

- [1] B. Archimede and T. Coudert, "Reactive scheduling using a multi-agent model: the scep framework," *Engineering Applications of Artificial Intelligence*, vol. 14, no. 5, pp. 667–683, 2001.
- [2] A. Baykasoglu and V. Kaplanoglu, "A multi-agent approach to load consolidation in transportation," *Advances in Engineering Software*, 2011.
- [3] M. Hülsmann, H. Kopfer, P. Cordes, and M. Bloos, "Collaborative transportation planning in complex adaptive logistics systems: A complexity science-based analysis of decision-making problems of groupage systems," *Complex Sciences*, pp. 1160–1166, 2009.
- [4] J. Kozlak, J. Créput, V. Hilaire, and A. Koukam, "Multi-agent environment for dynamic transport planning and scheduling," *Computational Science-ICCS 2004*, pp. 638–645, 2004.
- [5] A. Marasco, "Third-party logistics: A literature review," *International Journal of Production Economics*, vol. 113, no. 1, pp. 127–147, 2008.
- [6] M. Mes, M. van der Heijden, and P. Schuur, "Interaction between intelligent agent strategies for real-time transportation planning," *Central European Journal of Operations Research*, pp. 1–22, 2010.
- [7] J. Sauer and H. Appelrath, "Integrating transportation in a multi-site scheduling environment," *System Sciences, 2000. Proceedings of the 33rd Annual Hawaii International Conference*, pp. 9–pp, 2000.
- [8] R. Sprenger and L. Mönch, "A simulation framework for assessing the performance of cooperative transportation planning algorithms," *Proceedings of the 40th Conference on Winter Simulation*, pp. 2769–2776, 2008.
- [9] R. Sprenger and L. Monch, "icomas: an agent-based system for cooperative transportation planning in the food industry," *Holonic and Multi-Agent Systems for Manufacturing*, pp. 175–184, 2011.
- [10] J. Xu, B. Archimede, and A. Letouzey, "A distributed multi-agent framework for shared resources scheduling," *Information Control Problems in Manufacturing*, vol. 14, no. 1, pp. 775–780, 2012.
- [11] D. Yazan, A. Petruzzelli, and V. Albino, "Analyzing the environmental impact of transportation in reengineered supply chains: A case study of a leather upholstery company," *Transportation Research Part D: Transport and Environment*, 2011.
- [12] S. Zegordi and B. Nia, "A multi-population genetic algorithm for transportation scheduling," *Transportation Research Part E: Logistics and Transportation Review*, vol. 45, no. 6, pp. 946–959, 2009.