



HAL
open science

Applications of Integrated Near-field Antennas for Diagnosis of Electromagnetic Noises in Hybrid Electronic Architectures

Jean-Marc Dienot

► **To cite this version:**

Jean-Marc Dienot. Applications of Integrated Near-field Antennas for Diagnosis of Electromagnetic Noises in Hybrid Electronic Architectures. *Electronic Control, Measurement, Signals and their application to Mechatronics*, Jun 2013, Toulouse, France. hal-00932428

HAL Id: hal-00932428

<https://hal.science/hal-00932428>

Submitted on 17 Jan 2014

HAL is a multi-disciplinary open access archive for the deposit and dissemination of scientific research documents, whether they are published or not. The documents may come from teaching and research institutions in France or abroad, or from public or private research centers.

L'archive ouverte pluridisciplinaire **HAL**, est destinée au dépôt et à la diffusion de documents scientifiques de niveau recherche, publiés ou non, émanant des établissements d'enseignement et de recherche français ou étrangers, des laboratoires publics ou privés.



Open Archive Toulouse Archive Ouverte (OATAO)

OATAO is an open access repository that collects the work of Toulouse researchers and makes it freely available over the web where possible.

This is an author-deposited version published in: <http://oatao.univ-toulouse.fr/>
Eprints ID: 10577

To cite this version:

Dienot, Jean-Marc *Applications of Integrated Near-field Antennas for Diagnosis of Electromagnetic Noises in Hybrid Electronic Architectures*. (2013) In: *Electronic Control, Measurement, Signals and their application to Mechatronics*, 24 June 2013 - 26 June 2013 (Toulouse, France).

Any correspondence concerning this service should be sent to the repository administrator: staff-oatao@listes-diff.inp-toulouse.fr

Applications of Integrated Near-field Antennas for Diagnosis of Electromagnetic Noises in Hybrid Electronic Architectures

Jean-Marc Dienot ^{1,2}

¹Laboratoire Génie de Production, 47 avenue d'Azereix, F-65000 Tarbes, FRANCE

² Université P. Sabatier, Labceem, 1 rue Lautréamont, F-65000, Tarbes, FRANCE
jm.dienot@iut-tarbes.fr

Abstract— In modern electronic devices, increase of switching performances and integration design with new techniques and material make the compliances with the internal and external radiated behavior more and more critical. This paper present a synthetic state of challenging works to deal with this constraint. Different techniques and prototypes have been studied and developed to integrate electromagnetic sensors and probes in hybrid technology circuits. A good realistic and real-time evaluation of electromagnetic activity of these circuits should help for EMC background and designing, but also should be convenient to optimize the electromagnetic behavior during the real activity of the electronics.

Keywords-- *electromagnetic; near-field; probe; switching noise; electronic devices.*

I. INTRODUCTION

With the increase of the operating frequencies, switching rates and high level of integration in electronics devices, electromagnetic interferences (EMI) and unwanted couplings (EMC) are becoming serious [1]. For most of actual embedded applications, electronics 'architectures are established around high-level integrated power module and switching modes. These modules are relatively complex objects, consisting in association of power transistors as Insulated Gate Bipolar Transistor (IGBT) or Power Metal-Oxide-Silicon (MOS) chips, with signal and power diode devices, bond-wires, bump-wires and copper printed tracks[2]. The reduction of the integration volume and the design impact, as path length and height affect significantly the global system behavior and lead to new EMC couplings issues. For electronic circuit diagnoses and knowledge of the internal signal integrity and the closed electromagnetic environment, near-field measurement techniques have attracted a great deal of attention because of their high temporal and spatial resolutions, and local sensitivity [3][4]. There are two types of scanning probes and techniques that can be used: electric field probes constituted of small dipoles or monopole antennas, and magnetic field probes consisting of small loop antennas. For example, rigid-coaxial electric field probe, represented in Fig. 1, and loop-coaxial magnetic field probe, represented in Fig. 2, are accurately placed overhead the pads and the packaging of an IGBT and show the most important radiation source.

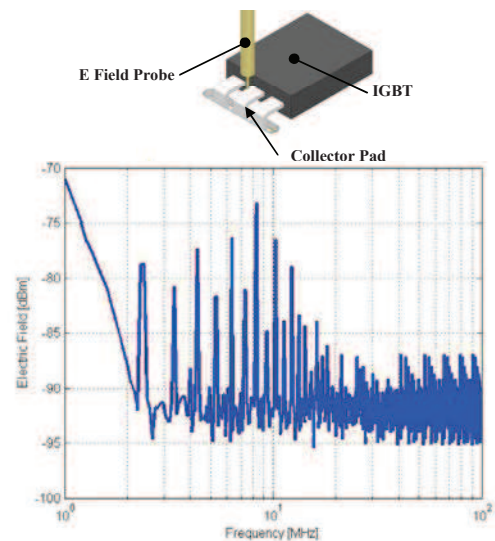

Fig. 1. Electric-field characterization with an IGBT package.

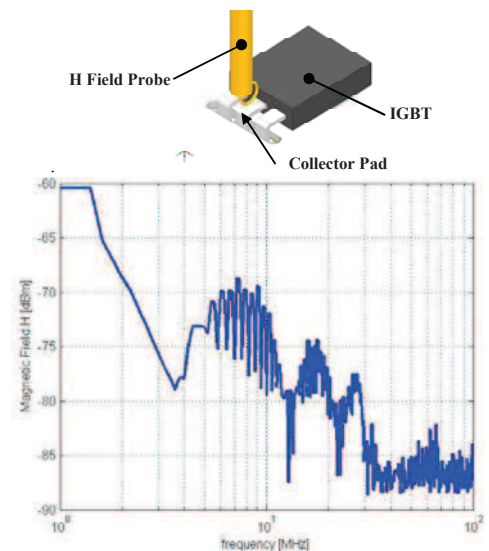

Fig. 2. Magnetic-field characterization with an IGBT package.

But the use a single probe with a cumbersome mechanical positioning system is inappropriate for devices at electrical and circuit level. For hybrid or integrated electronic modules,

impressive reductions in measurement capability for electromagnetically behaviors and conveniences in real-time acquisitions can be achieved via the use of a closed antenna matrix or array constituted by several integrated electromagnetic probes [5]. This is the main topic of this work presented here, with the state and perspectives of new sensors modules adapted to hybrid power electronic applications. After a quick review of the techniques for electromagnetic near-field sensors, the design for new devices is presented. With the effective realization of the prototypes, simulation and experimental results are presented. In conclusion, discussion for advantages and drawbacks of such a device for the evaluation of intra-EMI at circuit and PCB levels are presented.

II. PRINCIPLES AND PILOT STUDIES

A. Near-field Probe Principles

In actual modern devices, using high performance transistors and chips, the main switching behavior is driven by high current variations. In these works, we focus on magnetic field generation, whose principle is based on Faraday's law

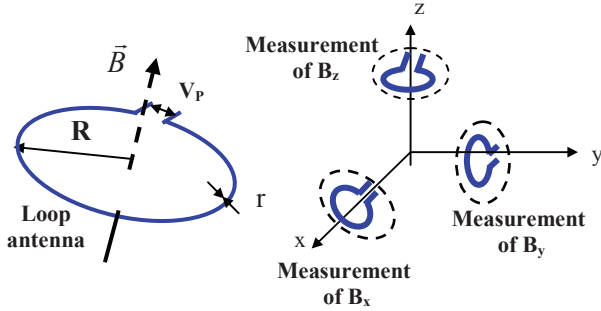

Fig. 3. Principles of magnetic field coupling and probing.

A magnetic field passing a loop generates a voltage proportional to the rate of change of magnetic flux through the circuit loop [6]. The induced current I flowing in such a loop is thus related to the open-circuit voltage V_0 :

$$V_0 = -\frac{d\Phi(t)}{dt} = -\frac{d}{dt} \int_S \vec{B} \cdot d\vec{S} \quad (1)$$

The probe's output voltage V_p is proportional to the perpendicular component of the impinging RF magnetic field and provides qualitative information about emission sources distribution. This procedure involves the determination of the performance factor F_m , defining the sensitivity as the ratio of the field strength in which the probe is immersed and the output voltage across the load connected to the probe. In these cases, the antenna factor is generally defined in far field condition. However, in near field mode, there exist some problems related to the spatial distribution of fields such as the difficulty to realize plane wave condition [7]. This frequency-dependent parameter does not devolve on the device under test or on probe position. Indeed, the different loop sizes allow the user to select the optimum probe for a given frequency.

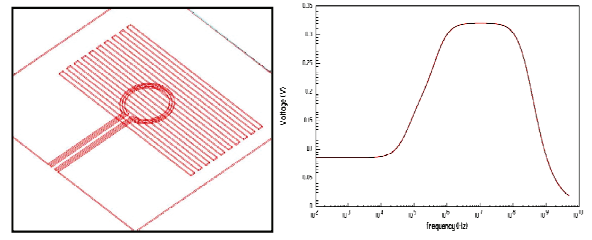

Fig. 4. Variation of field probe sensitivity according to different source positions (simulation).

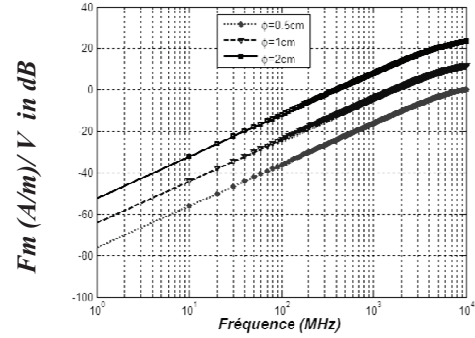

Fig. 5. Variation of field probe sensitivity according to different loop diameters (simulation).

In this study, we consider the probe size small enough compared to the wavelength at the frequency of interest, so that the current around the loop is assumed to be uniform [8]. So, an approximate method based on the knowledge of essential probe's characteristics, as input impedance and geometrical parameters, is used to determine this antenna factor.

$$F_m = 20 \log \left(\frac{V_p}{B} \right) = 20 \log \left(\frac{|-j\omega S|}{1 + \frac{R_R}{Z_L} - \omega^2 L_p C_p + j\omega \left(R_p C_p + \frac{L_p}{Z_L} \right)} \right) \quad (2)$$

The probe frequency characteristic stays linear until 1GHz with 20 dB/decade variation, which means that at this operating bandwidth, the sensor output qualitatively replicates the waveform of the incident magnetic field. Furthermore, this result allows us to determine quantitatively the transverse magnetic field radiated by any component [9].

III. FIRST APPLICATION: NT PROTOTYPE

We use a first application in a hybrid 3D structure with power chips based on Insulated Gate Bipolar Transistors (IGBT) and Diodes. This prototype has switching voltages and currents that can reach up to 6.5 kV and 3.6 kA respectively under 300ns. At these ratings, the parasitic electromagnetic coupling effects inside a module can drastically affect the EMC and nominal performances.

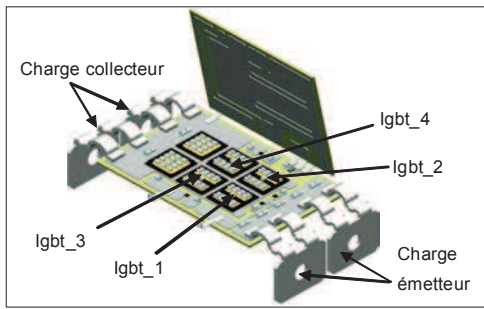

Fig. 6. Overview of a power switch NT.

At this point, we have to know how to place the probes to obtain the best coupling. The objective is to measure the H - field, close to power switching, so to know at first distributions of the currents in the power track below. Starting with CAD 3D design of the prototype, electromagnetic simulations have been driven to have a view and test on probe's placement and dimensions.

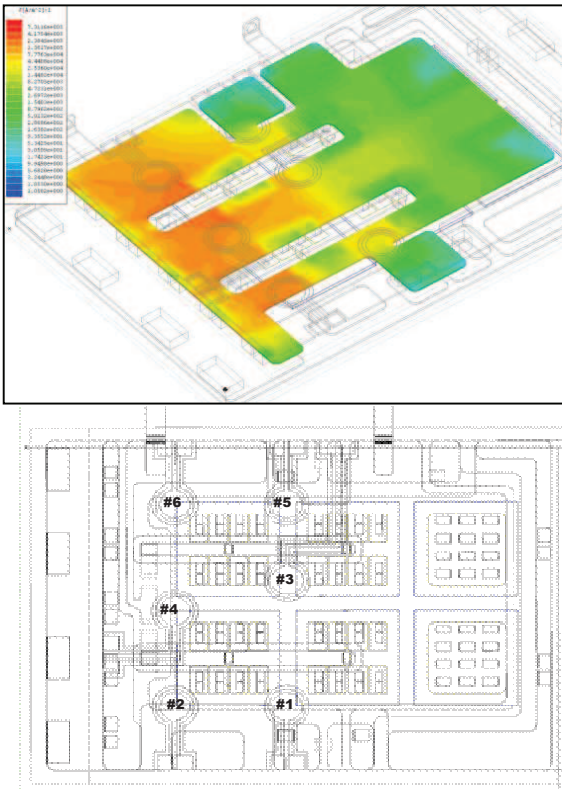

Fig. 7. CAD and EM simulations(example of surface current J in A/m²) of the NT prototype with probe's design.

Some implementation has been realized, with the probe's design etched on the upper DBC substrate of the NT prototype [10]. The bumping technology realizes a 3D balanced passive network, which corresponds to the range of electrically dimensions of propagation and radiations emissions phenomena's present in the system. This is a main contributor to resultant waveforms shapes and switching noise observed on internal and external connections. As current consumption

is observed at each switching time (rise and fall), parasitic oscillations are superposed in time domain representation of the electrical signals, and equivalent spectrum spread also give an indication of EMC consequences of the 3D power semiconductor integration process [5].

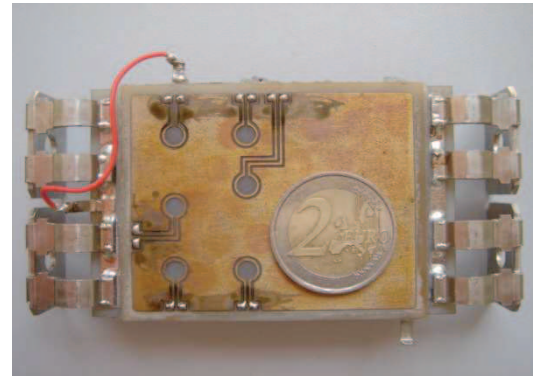

Fig. 8. Views of an elementary 3D hybrid switch (NT prototype) and the configuration of integrated probe's design over.

These results are obtained with two configurations for two kinds of the command drive: on emitter-loop, on gate-loop, with good concordances observed between calculated and measured noise and fields evaluations over the power structure.

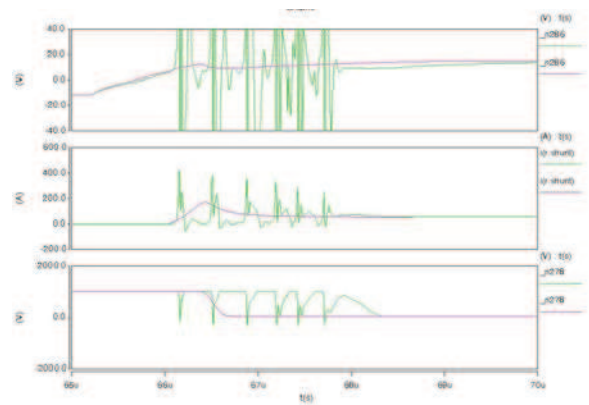

Fig. 9. Global waveforms of Gate-Emmitter voltage, Collector current and Collector-Emmitter voltage before and after oscillation's correction.

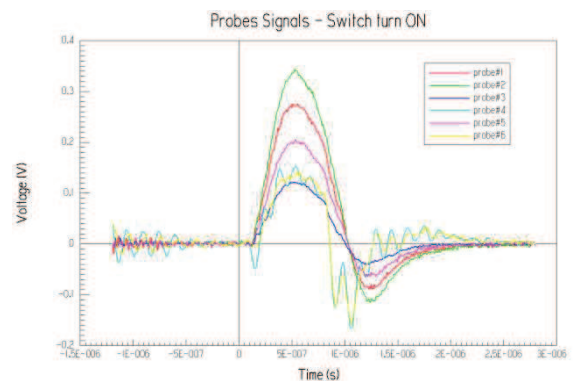

Fig. 10. Examples of time-domain responses of probe's signals.

IV. SECOND APPLICATION: EM-MATRIX

A. Design of the EM-Matrix prototype

A new probe design has been developed, with a matrix of elementary loops. The design is constituted of 20 loop probes with a diameter of $\phi=5\text{mm}$ each, printed on the upper side of a Direct Bond Copper (DBC) ceramic substrate of size (64mmx50mm). The conductor thickness is related to the substrate choice corresponding to $300\mu\text{m}$ for DBC substrate. In this configuration, the loop probes are etched on one side of the DBC substrate, the other side will be the ground plane of the matrix. With this new repartition of the elementary loops, the scanning acquisition time in this case can be divided by 20, depending on the number of elements, compared to the use of a single probe moving over the device

To validate this design before using it directly over electronic chips, a metallic strip is printed on a dielectric substrate, whose height is $h=0.8\text{mm}$ and relative permittivity $\epsilon_r=4.4$. The length of the microstrip line is $L=60\text{mm}$ and its width is $w=1.5\text{mm}$. A high power signal (equivalent frequency bandwidth about 100MHz) is injected at the port 1 of the microstrip line, with a current level $I=300\text{A}$.

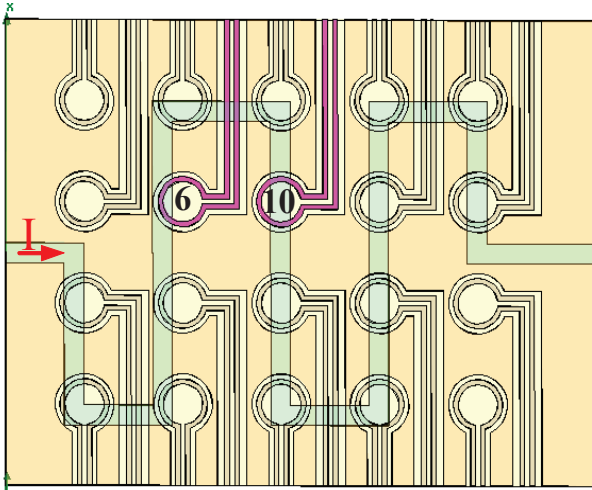

Fig. 11. Planar view of EM-Matrix design with test strip.

The EM-matrix configuration that we propose allows only the measurement of the normal component H_z of magnetic field. Indeed, the orientation to transverse direction doesn't allow obtaining a field mapping at a constant height. The ensemble consisting of the circuit in test and the EM-matrix is then simulated to reproduce the behavior of a measurement configuration. For a complete filled mapping above the test line, we simulate the voltage collected in longitudinal and transverse directions (O_x, O_y).

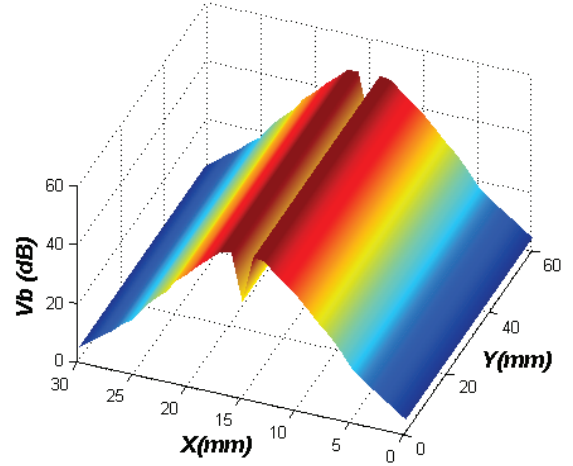

Fig. 12. Simulation of output EM-matrix voltage V_b along x-y plane due to current excitation of the test line (height 1mm).

The qualitative performance of the EM-matrix is carried out by studying the influence of its geometric parameters on the nature of the signal that they capture. The comparison of the signals received by EM-Matrix constituted of loops having two different diameters: 3mm and 5mm, points out a real improvement in the spatial resolution of the small EM-matrix.

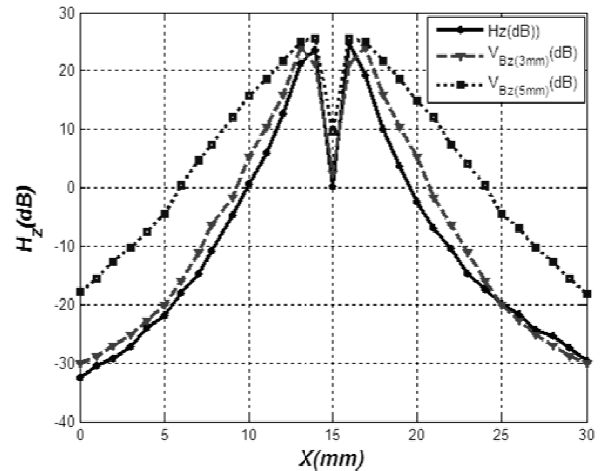

Fig. 13. Spatial resolution comparison of two EM-matrix configurations with theoretical model (probe #10).

We use the concept of Partial Electrical Equivalent Circuit (PEEC) method to extract and validate the electric parameters, including the value of coupling energy transfers between elementary loop and nodes in an electrical multi-pole configuration [12]. The metallic strip is excited by a power current source having a waveform similar to collector current of an IGBT during turn-off. Indeed, the voltage induced in each probe depends on the coupling with metallic strip and time variation of the current which flows below, di/dt .

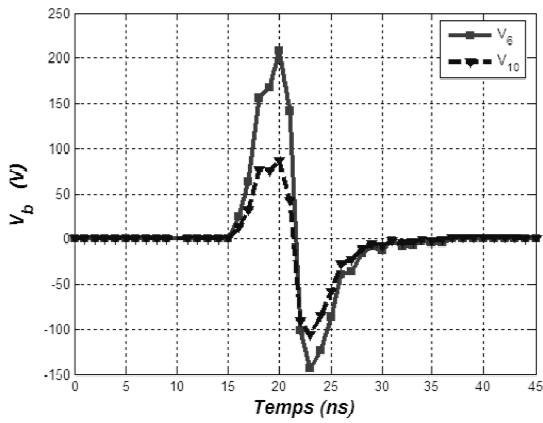

Fig. 14. Time transient simulation of voltage and coupling between probes of EM-Matrix and metallic strip.

B. Characterization of the EM-Matrix

Different versions have been realized with the aid of Labceem (Institute of Technology- University) for Copper-on-Epoxy prototypes, and Alstom Transports Company for the Copper-on Ceramic versions[11]. Two kinds of connecting for testing have been used for injection of reference signals: Coaxial RF frequency connectors and SMA High-frequency connectors



Fig. 15. View of EM-Matrix prototype #1: Ceramic substrate, diameter 3mm, BNC test connector.

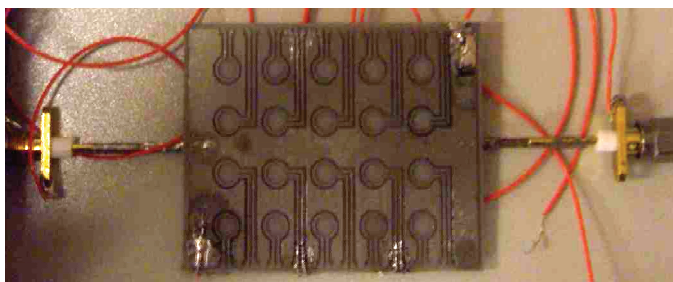

Fig. 16. View of EM-Matrix prototype #3: Ceramic substrate, diameter 5mm, SMA test connector.

We use a versatile generator producing different waveforms as high-power RF signals, electrostatic discharge (ESD), electrical fast transient (EFT) and surge[13].

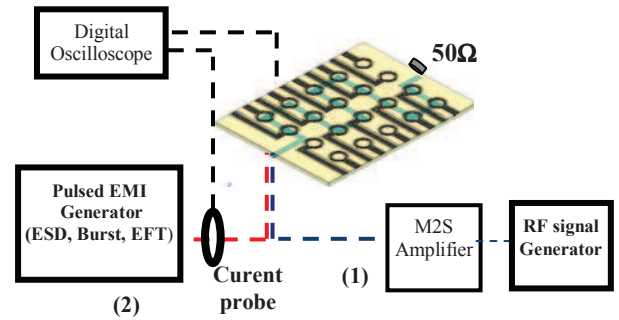

Fig. 17. Schematic diagram of the two measurement set-ups with : (1) the RF signal generator loaded on a 50Ω -resistance and (2) the Pulsed EMI Generator.

The injected current is measured by a high speed probe and digital oscilloscope system. The measurement of the time derivative of the magnetic field is carried out, for example, by both probes #6 and #10 to highlight different coupling configurations with the radiated source . These experimental results validate all the study and design of our antenna's modules.

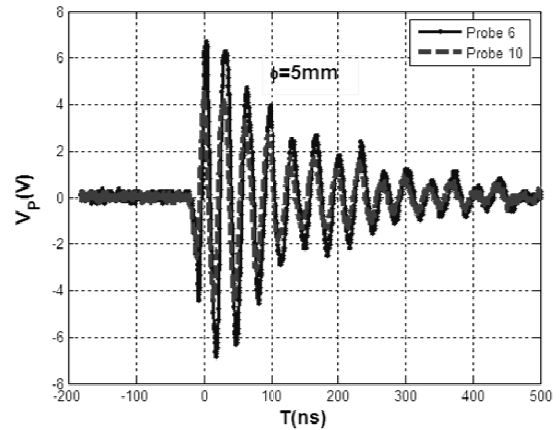

Fig. 18. Comparison of the time derivative of the B-field for two different probe positions on the EM-Matrix.

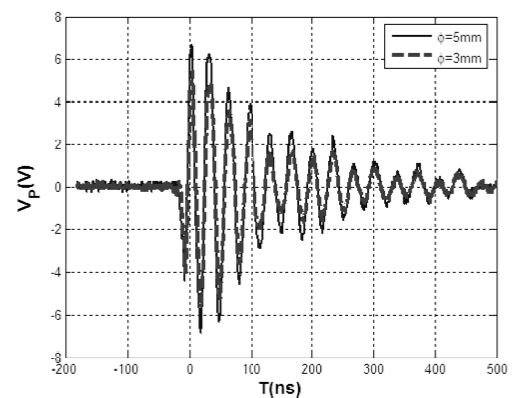

Fig. 19. Comparison of the time derivative of the B-field for two different size of probe (3mm and 5mm).

V. CONCLUSIONS

A. Synthetisis of the works

We presented a state of advanced technical works dedicated to diagnose the EMI (Electromagnetic Interference) in electronic modules. With high-speed current switching in chips and short microstrip in integrated structure, internal electromagnetic fields become very intensive and can produce severe cross talks and magnetic couplings. It is necessary to have some techniques to evaluate these near-field emissions over the structure of the device, and during its nominal activity. New antenna structure is proposed to improve time and spatial acquisition with transient near-field phenomena's. Another feature is the ability to be adapted and integrated to a large range of modern electronic chips, as hybrid power switches.

The principle is a two-dimensional array of radio-frequency magnetic field probes printed on a ceramic substrate. This substrate can be placed and integrated very closely over the power module. Theoretical and technical studies have been presented for the determination and the optimization of electrical and geometrical parameters of the probes integrated on a solid substrate, as PCB or Ceramic.

To comply with, both electrical modeling and measurements were performed to highlight electrical performances of the integrated probes as sensitivity, spatial resolution and coupling factors. Many test show the adaptability to different types applications and electromagnetic noises generated.

B. Perspectives and works in progress

A perspective and future development of these works is to extend its use to sense transient magnetic fields in real time, with the device is in nominal and real activity. So, a complete spatial scan over the surface (ex: 8cmx4.5cm) of hybrid devices will give a realistic evaluation of magnetic emission during the electrical activity of the circuit.

For this, we actually work on two developments to achieve these goals[14]:

-The synchronous connecting of the 20 ports of the EM-Matrix module, dealing with the problem of differential/common modes in transmission lines connected to the EM-Matrix modules.

-The acquisition and the treatment of the 20 voltages equivalent to the 20 images of the field over the circuits. architecture of a signal processor dedicated and calibrated for this operation is in study.

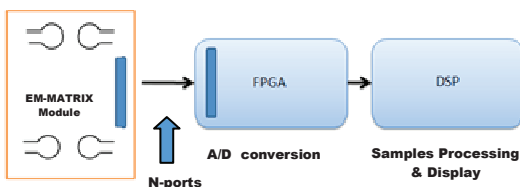

Fig. 20. Diagram of Multi-ports Embedded Acquisition system proposed for EM-Matrix modules [14].

Some special procedures for correct calibration of the 20 loops, including all the losses of the connectors and wires have also to be considered. The main future challenge of the global EM-Matrix project is to achieve the complete embedded acquisition system. Coupled to a signal processor, it should be a convenient system for both real time calibration and control of the chips under the module, so to optimize the switching noise and EM fields generated by the transient behavior of electronic circuits.

REFERENCES

- [1] R. Redl, "Power electronics and electromagnetic compatibility", in Proc. 27th Annual IEEE Power Electronics Specialists Conference, 1996, pp. 15– 21.
- [2] N. Mohan, T.M. Undeland and W.P. Robbins, Power Electronics Converters: Applications and Design, 2nd ed., J. Wiley & Sons, 1995.
- [3] J.C. Bolomey, "Introduction to near-field techniques for EMC applications: state of the art and prospectives", in Proc. IEEE International Symposium on Electromagnetic Compatibility, 2001, Vol.1, pp. 356.
- [4] M. Kanda, "Standard probes for electromagnetic field measurements", IEEE Transactions on Antennas and Propagation, Vol. 41(10), pp.1349–1364, Oct. 1993.
- [5] G. Lourdel and J.M. Dienot, "Study, design and validation of an integrated close field-probe system for EMC investigations on a power hybrid structure", in Proc. IEEE International Symposium on Electromagnetic Compatibility, 2004, Vol. 2, pp. 353-356.
- [6] L. Bouchelouk, Z. Riah, D. Baudry, M. Kadi, A. Louis and B. Mazari, "Characterization of electromagnetic fields close to microwave devices using electric dipole probes", International Journal of RF and Microwave Computer Aided Design, pp. 146-156, Feb. 2008.
- [7] Ishii M.; Komiyama K., "A measurement method for the antenna factor of small loop antenna by measuring the input impedance" Conference on Precision Electromagnetic Measurements Digest, pp. 80-81, June 2004.
- [8] IEEE Std 1309-2005, "IEEE standard for calibration of electromagnetic field sensors and probes, excluding antennas, from 9 kHz to 40 GHz", Revision of IEEE Std 1309-1996, pp.1-104, 2005.
- [9] T. Harada, N. Masuda and M. Yamaguchi, "Near field magnetic measurements and their applications to EMC of digital equipment", IEICE-Transactions on Electronics, Vol. E89-C (1), pp. 9-15, Jan. 2006.
- [10] G. Lourdel, J.M. Dienot, E. Dutarde, "Integrated Near-field probes for power switch Aln structure", Brevet FRA0405299, Mai 2004, International Patent Extension, USA, June 2005.
- [11] E. Batista, J.M. Dienot, "EMC characterizations for Switching Noise Investigation on Power Transistors", IEEE International Symposium on Electromagnetic Compatibility, Detroit, USA, August 18-23, 2008.
- [12] A. E. Ruehli, and al., "Non-orthogonal PEEC formulation for time- and frequency-domain EM and circuit modeling", IEEE Transactions on Electromagnetic Compatibility, Vol. 45, pp. 167-176, May 2003.
- [13] Electromagnetic Compatibility (EMC), Part 4: Testing and Measurement Techniques, Section 5: Surge Immunity Test, EN 61000-4-5 Std, 1995.
- [14] J.Tanchon, J.M. Dienot, J. Gonzalo, "Développement d'un système d'acquisition numérique pour modules EM-Matrix", Technical Report , Labceem-Tarbes, 2010