



HAL
open science

Modeling and analysis of railway GSMK reception vulnerability to electromagnetic interference

Souheir Mili, David Sodoyer, Virginie Deniau, Marc Heddebaut

► **To cite this version:**

Souheir Mili, David Sodoyer, Virginie Deniau, Marc Heddebaut. Modeling and analysis of railway GSMK reception vulnerability to electromagnetic interference. *International Journal of Advances in Computer Science and Technology*, 2013, 2 (7), p115-118. hal-00911676

HAL Id: hal-00911676

<https://hal.science/hal-00911676>

Submitted on 29 Nov 2013

HAL is a multi-disciplinary open access archive for the deposit and dissemination of scientific research documents, whether they are published or not. The documents may come from teaching and research institutions in France or abroad, or from public or private research centers.

L'archive ouverte pluridisciplinaire **HAL**, est destinée au dépôt et à la diffusion de documents scientifiques de niveau recherche, publiés ou non, émanant des établissements d'enseignement et de recherche français ou étrangers, des laboratoires publics ou privés.



Modeling and analysis of railway GSM-R reception vulnerability to electromagnetic interference

Souheir Mili¹, David Sodoyer¹, Virginie Deniau¹, Marc.Heddebaut¹

¹ Univ. Lille Nord de France- F-59000 Lille, IFSTTAR, LEOST, F-59650 Villeneuve d'Ascq, France
{souheir.mili, david.sodoyer, virginie.deniau, marc.heddebaut}@ifsttar.fr

ABSTRACT

In this paper, we investigate the impact of electromagnetic interference (EMI) on the quality of a Global System for Mobile communications - Railways (GSM-R) ground to train radio link. Scenarios of radiated electromagnetic (EM) disturbances applied to a Gaussian minimum shift keying (GMSK) based receiver, potentially impairing the communication quality are assessed. The objective is to establish a link between the disturbance characteristics of the interference and the received communication quality; the physical layer is considered. A GSM-R communication chain is modeled. Radiated EMI perturbations are injected to study, at the receiver, the bit error rate (BER). The signal plus interference characteristics are analyzed to detect the interference. In a second step, this work will be used to identify suitable criteria to implement an automatic EMI detection and identification system.

Key words : GSM-R, GMSK, electromagnetic interference (EMI), railway, detection.

1. INTRODUCTION

The European Commission, railway operators and the whole railway industry, answering to the critical issue of railway interoperability throughout Europe, designed a new, unique control command system named European Train Control System (ETCS), which is a part of the European Rail Traffic Management System (ERTMS). ETCS makes rail transport safer and more competitive. It also guarantees a common standard that enables train to cross national borders and also enhances effectiveness [1].

ETCS considers two important components: the train to wayside digital radio system named "Euroradio". Euroradio is based on the GSM-Railway system for voice and data communications and the "Eurobalise" system dedicated to short range track to trains communications as well as to train absolute localization [2]. GSM-R is based on the GSM cellular radio standard with some specific railway modifications. As for GSM, GSM-R uses a Gaussian Minimum Shift Keying (GMSK) modulation. The railway common European frequency band uses a lower extension of

the 900MHz band, between 876 MHz and 915 MHz for the uplink and between 921 MHz and 960 MHz for the downlink. An infrastructure based GSM-R network is installed along the railway track consisting notably of consecutive Base to Transceiver Stations (BTS) [3]. Due to the distance of about 3 or 4 km between consecutive BTS, the GSM-R received power varies continuously and potentially quickly as the train moves. The received power at the train antenna level ranges typically between -35 dBm and -92 dBm [4]. In Europe only, in excess of 150,000 km of railway track are expected to be equipped with GSM-R in the coming years.

On GSM conventional cellular networks, one of the most important sources of interference disturbing the communication is the signal coming from another Base Transceiver Station (BTS) operating in the same channel or using carrier frequencies in the vicinity of the desired transmission [5]. Knowing that GSM-R shares most of the technical characteristics of GSM, this type of disturbance also affects the GSM-R system.

Moreover, the specific railway environment introduces supplementary disturbances that produce interference noise in the GSM-R allocated channels, this EM environment could also lead to a degradation of the quality of the communication service. Studies have shown that, in a railway environment, significant EM interferences are also provided by the sliding pantograph to catenary contact. This generates wide band interference covering up to the GSM-R frequencies [6].

In order to assess the impact of the presence of these interferences on the receiver, and possibly to detect and identify some characteristics associated to these interferences, we have performed a study presented in this contribution. This paper is organized in six sections. The second section introduces the simulation model used for the study. The third section details the communication chain and its associated parameters. The fourth section presents some possible railway interference as well as the considered pulse used in this work. In section 5, we analyze the BER and then, in section 6, the analysis model used to detect the presence of an interfering signal. Finally, section 7 concludes this article and suggests some perspectives.

2. SIMULATION MODEL

In order to analyze the impact of the interference, a model of a GSM-R emission - reception chain was developed. Since the

GSM-R communication system uses the GSMK modulation, our model uses a GMSK modulator and demodulator. Then, the study will mainly focuses on the impact of the interference signals on this receiver GMSK demodulator.

Detailed information concerning the effects of external electromagnetic interference in GSM-R systems are not yet widely published [7]. Therefore, concentrating on the one hand, on the GMSK modulation and demodulation schemes and, on the other hand, on the characteristics of the interference, we decided to look for possible relationships between the Bit Error Rate (BER) and the characteristics of some specific railway electromagnetic disturbances.

To evaluate these relationships, transient EM interference signals are modeled and introduced in the communication chain, at the receiver antenna input level. We evaluate their effects. Responses are then analyzed trying to detect the presence of the interference.

3. COMMUNICATION CHAIN

For the simulations, a NRZ burst comprising 156 bits is generated, lasting for a standard GSM time burst of 577 μ s. Figure 1 shows this burst. Therefore, each bit has a transmission duration time (T_b) of 3.7 μ s [8].

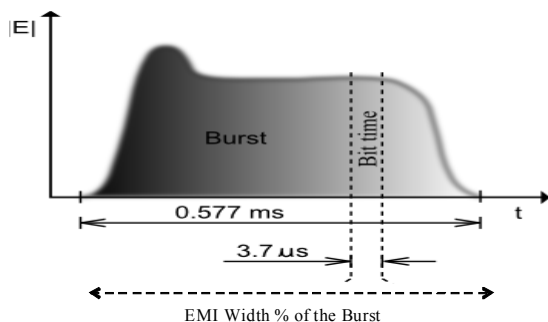

Figure 1: GSM-R Burst.

This time slot is modulated and then sent in a pure Additive White Gaussian Noise (AWGN) propagation channel.

In the GSM standard, Gaussian Minimum Shift Keying with a time-bandwidth product of 0.3 was chosen as a compromise between spectral efficiency and intersymbol interference. With this value, 99% of the power spectrum is within a bandwidth of 250 kHz. Considering these values, the GSM spectrum is divided into 200 kHz channels for multiple access, with a transmission speed of 271 kb/s [9].

Figure 2 depicts the used communication chain.

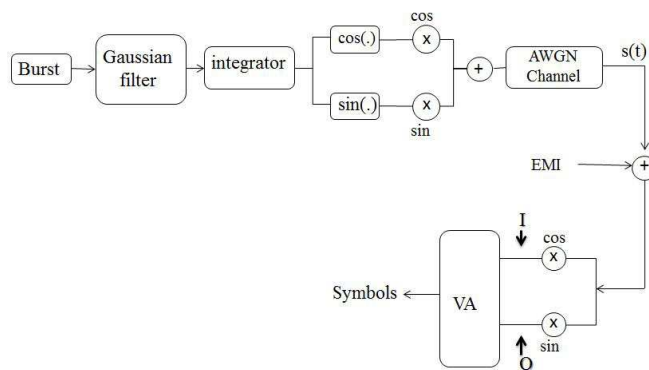

Figure 2: Communication chain (quadratic representation).

At the emission chain, there are no EM interferences introduced. Therefore, the formulation of the signal according to the principle of GMSK modulation can be written using the following equation:

$$s(t) = \sqrt{\frac{2E}{T_b}} [a_n C(t) \cos(2\pi f_c t) + b_n S(t) \sin(2\pi f_c t)] + b(t) \quad (1)$$

Where T_b is the bit time duration, $b(t)$ represents the noise corresponding to the AWGN signal, $C(t) = \cos \frac{\pi t}{2T_b}$ and

$S(t) = \sin \frac{\pi t}{2T_b}$ are the effective I and Q pulse shapes, and a_n and b_n are the effective I and Q binary data sequences. Where $a_n = \cos x_n = \pm 1$ and $b_n = \alpha_n \cos x_n = \pm 1$, and where x_n is a phase constant required to keep the phase continuous at the data transition points $t = nT_b$ and $t = (n+1)T_b$.

As an illustration, a corresponding frequency magnitude representation, in applying $f_c = 900$ MHz, is given in Figure 3.

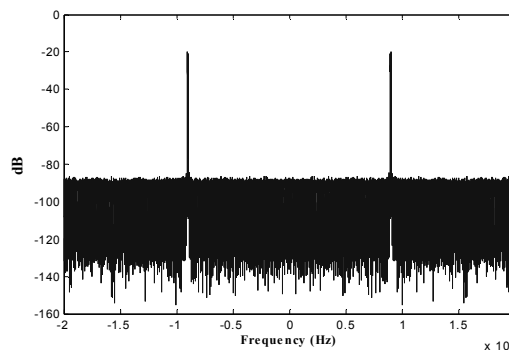

Figure 3: DSP representation of transmitted signal (perfect mode).

4. RAILWAY INTERFERENCE

The pantographs on the trains and the catenary, installed all along the track, form a sliding complex mechanical system. On a high speed train, several MW of electric power feed the train through this sliding system. Train pantographs and track catenary are coupled via the contact force between the pantograph heads and the catenary wire. Too large contact

force variation can lead to loss of contact, arcing and wear as well as damage to the system. Therefore, it becomes clear that the contact between the catenary wire and the pantograph is at the heart of the arcing phenomenon [10]. Erratic detachments and attachments occur frequently. They are related to the speed of the train as well as the lifting force of the pantograph and to the weather conditions (ice, fog...). This leads to the creation of electric arcs. The radio frequency range covered by these arcs extends up to 1 GHz and therefore covers the GSM-R allocated bands.

We model this interference by a Gaussian waveform pulse of variable characteristics (time occurrence, repetition rate, power...). Any other waveform corresponding to the above mentioned arcs or other interfering signals could be easily introduced in the model. As for the AWGN, the interfering pulses are superimposed on the GSM-R signal received by the train antenna. A frequency magnitude representation of the disturbed signal is given Figure 4.

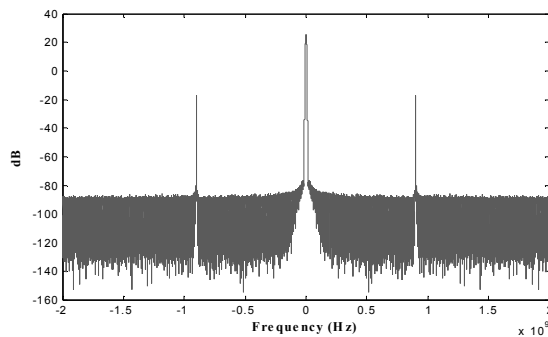

Figure 4: DSP representation of a specific generated interfering signal (peak amplitude of the Gaussian disturbance= 10^5 V).

5. BER EVALUATION

The received signals are demodulated using a Viterbi algorithm (VA). The VA employs the magnitude of the complex correlation. That is, of all possibility merging at a state, only the one with the maximum correlation magnitude is retained as the effective state.

We start the exploitation of the model by evaluating the quality of the communication in terms of BER and considering that the synchronization at the reception is perfect. The BER is evaluated transmitting a random sequence of data and analyzing the received signals after the VA observing that the interferences don't disturb the communication synchronization.

Figure 5 represents the 2 Dimensions variation of the BER, according to the amplitude and the pulse width. The "pulse width" corresponds to the time duration of the Gaussian interference. This disturbance duration is expressed as a percentage of the bit width. In the same time, we also consider the variation of the amplitude of the disturbance. Considering a fixed width pulse and varying in the first time the amplitude of the disturbance, we carried out the medium value of the BER for 100 runs. Each medium value represents the error of

the communication system for a given amplitude and width. Thereafter, we varied simultaneously the width and the amplitude, and we calculate the average BER value obtained for the 100 runs.

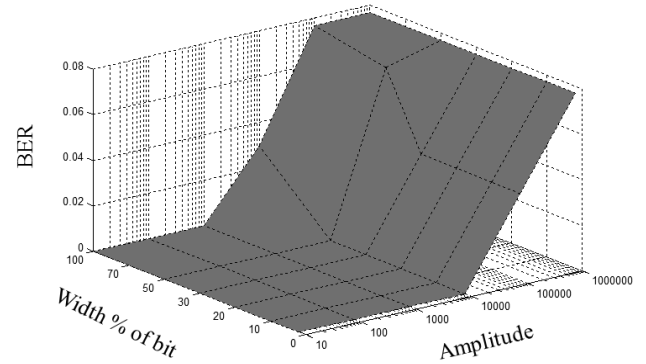

Figure 5: BER in terms of percentage of the disturbance bandwidth and amplitude

The "amplitude" axe represents the peak value of the Gaussian disturbance, while the signal amplitude is constant and equal to 1.

We notice that the disturbance peak values have to be very high to induce errors on the communication signal, due to the noise induced on the GSM frequency channel by the Gaussian disturbance being very low. The poor impact of the Gaussian disturbance on the frequency channel is illustrated in Figure 4 with a 105 V peak value Gaussian disturbance.

6. ANALYSIS MODEL

The second part of this work deals with an analysis model which could permit to quickly distinguish a disturbed mode from a good communication. Two modes of operation are then considered. The first mode is a normal mode without interference, thus considering only the AWGN present in the channel. This situation represents the system in usual exploitation with, for example, a perfect catenary wire to pantograph contact. In the second mode, called the disturbed mode, the transient EM interference signal is superimposed on the GSM-R channel, at the input of the receiver. From Figure 2, we extract the following receiver subset presented in Figure 6.

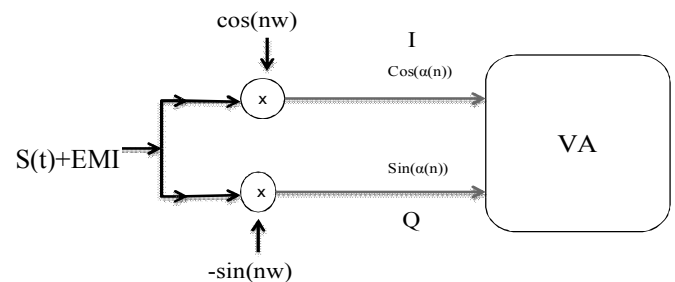

Figure 6: A quadratic representation of the demodulation chain

A quadratic analysis of the received signal using the in-phase signal noted I, and the quadratic signal noted Q is now performed. I and Q signals are extracted from the demodulated chain. I and Q signals are the input parameters of the Viterbi algorithm. Figure 7 represents I and Q signals without and in presence of the transient disturbance.

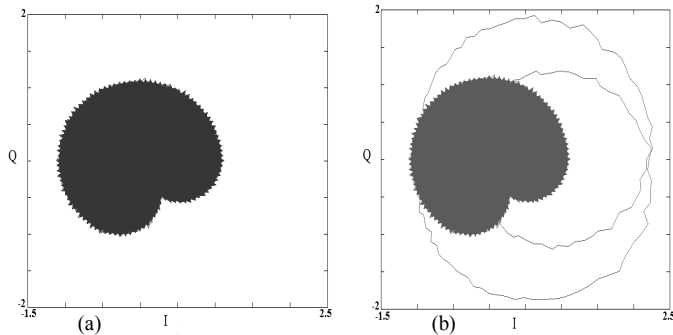

Figure 7: Quadratic representation of signals, (a): perfect mode, (b): Disturbed mode.

Figure. 7 shows significant differences between the representations of the disrupted and normal operating mode. The disturbance induced a strong distortion altering the I-Q pattern. This clear distinction between the two modes could then be exploited in order to detect the presence of specific disturbances in the communication system. Obviously, the differences between curves (a) and (b) are directly associated to the waveform and level of the interfering signal. In consequence, we have to confirm these observations in applying new disturbing signals.

7. CONCLUSION

In this paper, we contributed to the detection of the presence of an interfering signal in a GSM-R communication channel. We modeled a GSM-R communication channel and considered the GMSK demodulator and its associated Viterbi algorithm. Using this model, we assessed the quality of service (QoS) of this communication chain based on BER calculation. BER values were calculated as a function of the characteristics of the interfering signals.

The introduction of a variable impulsion in the system of communication allowed us to check the impact of the EM disturbance on the BER, according to the amplitude and the width of the disturbing impulsion.

In a second step, we tried to find an effective representation to detect the presence of a disturbance in the communication system. The selected quadratic evaluation method shows an effective graphic representation able to detect the presence disturbance.

In a future work, we will continue to investigate if this representation or any other one has also the capability of identifying accurately some specific disturbances present in the communication channel.

ACKNOWLEDGEMENT

The research leading to these results has received funding from the European Community's Framework Program FP7/2007-2013 under grant agreement n°285136".

REFERENCES

1. **The European Railway Traffic Management System (ERTMS)**. (2011, Aug. 22). Online Available. <http://www.ertms.com/>
2. S. Midya and R. Thottappillil. **An Overview of Electromagnetic Compatibility Challenges in European Rail Traffic Management System**, Journal of Transportation Research Part C: Emerging Technologies, Elsevier, (Ed.), Vol.16C, pp. 515-534, 2008.
3. D. Mansson, R. Thottappillil, M. Bäckström and O. Lundén. **Vulnerability of European Rail Traffic Management System to Radiated Intentional EMI**, IEEE Transactions on Electromagnetic Compatibility, vol. 50, no. 1, pp. 101–109, 2008.
4. T. Hammi, N. Ben Slimen, V. Deniau, J. Rioult and S. Dudoyer. **Comparison between GSM-R coverage level and EM noise level in railway environment**, in Proc. ITST, Lille, France, 2009, pp. 123–128.
5. R. Adriano, N. Ben Slimen, V. Deniau, M. Berbineau and P. Massy. **Prediction of the BER on the GSM-R communications provided by the EM transient disturbances in the railway environment**, Proc. EMC Europe, pp.771 -775 Sep. 2008.
6. Q. Shan and Y. H. Wen. **Research on the BER of the GSM-R communications provided by the EM transient interferences in high-powered catenary system environment**, in Conf. ICEAA, Sydney, Australia, 2010, pp. 757–760.
7. S. Theodore, Rappaport. **Wireless Communications Principles and Practice**, Publishing House of Electronics Industry, Beijing.
8. X. Iagrange, P. Godlewski and S. Tabbane, Eds. **Réseaux GSM-DCS - Des principes à la norme**, Paris: Hermès, 1996.
9. J.G. Sempere. **An overview of the GSM system by Javier Gozalvez Sempere**, April 1998.
10. P. V. Verschraegen. **A Model of the Pantograph Arc Impedance for 50 Hz Catenary Voltage**, Master of Science Thesis, Stockholm Univ, Sweden 2010.