

Fiber ring resonators with Q factors in excess of 10^{10} for Time and Frequency Applications

K. Saleh, A. Fernandez, O. Llopis

CNRS ; LAAS ; Université de Toulouse
7 av. du Colonel Roche, BP 54200, 31031 Toulouse, France

G. Cibiel

CNES, 18 avenue Edouard Belin, 31410 Toulouse, France

Abstract—The design of ultra high Q factor fiber ring resonators is described. The resonators are characterized with a microwave frequency modulation technique, which allows a precise measurement of their performance. Optoelectronic oscillators are then realized. The phase noise performance is compared to the results obtained with lower Q factor resonators, and the relatively high intra-cavity bandwidth noise is discussed.

Keywords—Microwave-optics; optoelectronic oscillator; optical resonator; optical fiber; phase noise

I. INTRODUCTION

In the field of low phase noise microwave sources, the opto-electronic oscillator (OEO) is now very popular. Since the first delay line feedback OEOs in the 1990s [1,2], based on optical fiber spools of a few kilometers, the design of these systems has evolved towards more compact oscillators based on optical resonators. These resonators can be whispering gallery mode resonators, such as mini disk monocrystalline resonators [3-5], passive fiber loop resonators [6,7] or active fiber loops resonators, i.e. coupled optical and electronic oscillator (COEO) [8,9].

Recent work [7] has shown the capability of fiber ring resonators (FRRs) of featuring very high optical quality factors (Q_{opt}). These FRRs are compact and easy to use. However, their high quality factor, combined with significant intra-cavity power enhancement factor, lead to the generation of nonlinear optical effects inside the resonator, especially Rayleigh and Brillouin scattering [10]. When the FRR is used to stabilize the frequency of an optoelectronic oscillator (OEO), these nonlinear optical effects degrade the OEO phase noise. In order to eliminate a great part of these effects, an optical isolator has been inserted inside a 100 m long FRR that featured a Q_{opt} of $2 \cdot 10^9$. The use of this FRR to stabilize the frequency of a 10 GHz OEO has resulted in a phase noise level as low as -52 dBc/Hz at 10 Hz offset frequency [7]. The investigations described in this paper tried to extend the performance of such a system to higher Q factors, in order to reach a lower phase noise level for the OEO. However, even if we have been successful in increasing the Q factor of our resonators above 10^{10} , the resulting phase noise is higher than the one obtained with the resonator with Q_{opt} of $2 \cdot 10^9$. This problem is discussed and some hypothesis on the origin of this noise are given.

II. OEO BASED ON FIBER RING RESONATORS

The fiber ring resonator structure is depicted in Figure 1. It uses one or two optical couplers, preferably two if a filtered output is needed (resonator used in transmission mode). The parameters which can be optimized to get the desired Q factor and insertion losses values are the coupling coefficients (and couplers residual losses), the residual losses of all the elements of the loop (including fiber splices) and the fiber type. Of course, a trade-off has to be found between high Q factor and low insertion losses.

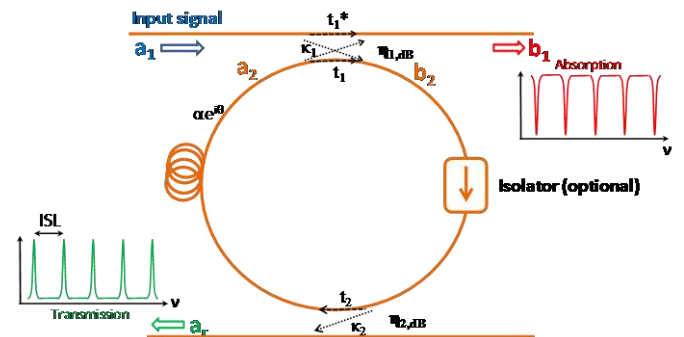

Figure 1 : Fiber ring Resonator topology

The previously realized ring resonators were in the range of 20 m to 100 m length. Because it is the optical resonator bandwidth which is preserved in the microwave application, the microwave Q factor of the OEO is degraded by the ratio of the microwave to optical carrier frequency, which is about 20 000 for a 10 GHz application (optical carrier at 194 THz, or 1550 nm). Therefore Q_{opt} must be higher than 10^9 in order for this technology to be competitive with the best microwave resonators, which means a fiber ring larger than 10 m and a low coupling factor, or a fiber ring of 100 m if lossy elements are included in the loop. With this approach, most of our designs were based on 20 m fiber rings, featuring Q factors of about $3 \cdot 10^9$, using either SMF fiber or PM fiber. A 100 m ring has also been designed, using PM fiber and including an isolator in order to prevent the growing up of Stimulated Brillouin Scattering (SBS), which appears at relatively low input power because of the large intra cavity power enhancement factor inside the resonant loop.

These resonators have been used to stabilize various OEOs. All the OEOs have the same topology, which is described in previously published papers [7,10] and depicted in Figure 2. The laser is first locked to the resonator frequency thanks to a Pound Drever Hall (PDH) feedback loop ; the oscillation is started thanks to a second loop which is a microwave loop including one or two amplifiers, a phase shifter and a dielectric resonator filter centered at 10.2 GHz.

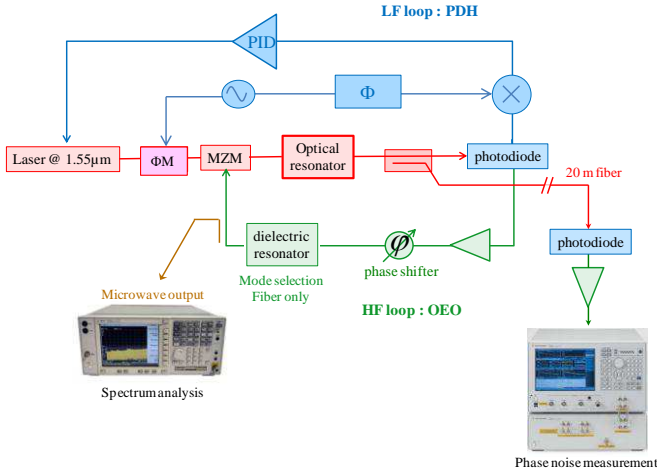

Figure 2 : OEO topology, including a PDH laser stabilization loop and an microwave oscillation loop.

The phase noise results obtained on 10.2 GHz OEOs realized using this system are depicted in Figure 3. In each case, the oscillator system is the same and only the optical resonator is removed and replaced by another. Three types of resonators are used in the OEOs described in this Figure : a mini-disk of CaF_2 , a 20 m ring resonator (two spectra plotted, for different optical input power in the resonator) and the 100 m ring resonator which includes an isolator.

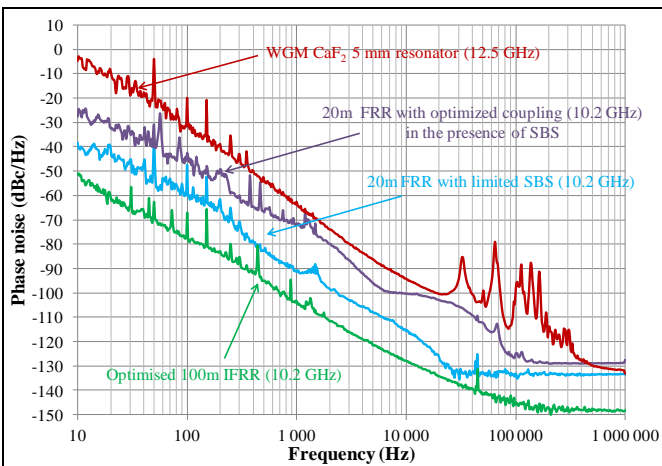

Figure 3 : Phase noise of previously realized OEOs, stabilized with the same PDH circuit, including one OEO based on a CaF_2 mini-disk ($Q = 10^8$), one OEO realized with a 20 m FRR ($Q = 3.5 \cdot 10^9$) and one OEO stabilized with a 100 m FRR which includes an isolator ($Q = 2 \cdot 10^9$).

The best result is obtained with the 100 m FRR OEO, featuring -52 dBc/Hz at 10 Hz offset, and -128 dBc/Hz at 10 kHz. With this resonator, we have been able to remove the main nonlinear optical effects limiting the performance of the

20 m FRR OEO. The phase noise of this oscillator is only limited by the RF amplifiers phase noise, and the measured spectrum can be described by a Leeson type approach.

III. ULTRA HIGH Q RESONATORS DESIGN

Our goal was then to increase again the Q factor of our FRR, above 10^{10} (which means an equivalent Q factor at 10 GHz above 500 000). To this purpose, two ways can be followed : realizing a 100 m long FRR without isolator in the loop, or realizing a much longer FRR, such as a 1000 m FRR, and keeping the isolator which prevents some of the optical nonlinear effects (particularly the growing up of SBS).

In such a design, a trade-off has to be found between Q factor enhancement and the optical losses through the resonator (high Q means low coupling, which induces losses). Optical losses higher than 5 dB means RF losses higher than 10 dB, which are added to the losses of the microwave to optical and optical to microwave conversion which are generally high. We have thus chosen to limit optical IL to about 5 dB. The resonator is modeled either using an equivalent circuit approach on ADS software, or using a dedicated Matlab approach (both give the same results). The resonator performance is simulated varying the coupling factors of the optical couplers (the other parameters being the residual losses of the optical devices provided by the devices manufacturers).

For the 100 m resonator without isolator, a coupling factor close to 1 % meets our requirements in Q and insertion losses (IL). In the case of the 1000 m resonator, a coupling factor of about 10 % is necessary to maintain relatively low IL. This coupling factor also corresponds to the maximum intra cavity power enhancement factor.

The resonators have then been realized, and included in metallic boxes with passive thermal isolation. The devices characterization is performed still using the PDH stabilization loop : the laser is stabilized on one resonance, and the lateral resonances are measured using a microwave vector network analyser (VNA), i.e. the green loop in Figure 2 is replaced by the VNA.

Figure 4 depicts the transmission curve (S_{21}) obtained on the 100 m resonator (actually, more precisely, it is a 120 m resonator). A Q_{opt} of $1.25 \cdot 10^{10}$ has been measured, with optical IL of 7.5 dB (a bit degraded compared to our simulation).

Figure 5 depicts the same measurement performed on the 1000 m resonator. In this case, a Q_{opt} of $1.7 \cdot 10^{10}$ has been reached, with optical IL of 4.1 dB, which was perfectly in agreement with our simulated data. The measured S_{21} phase curve is also depicted in this figure (it is this parameter which stabilizes the oscillator), and the high slope looks very clean and can be easily measured using our microwave modulation technique.

IV. OEOs WITH Q IN EXCESS OF 10^{10}

These two resonators have then been included in the OEO system described in Figure 2. A 10.2 GHz oscillation has been obtained, and its phase noise has been measured.

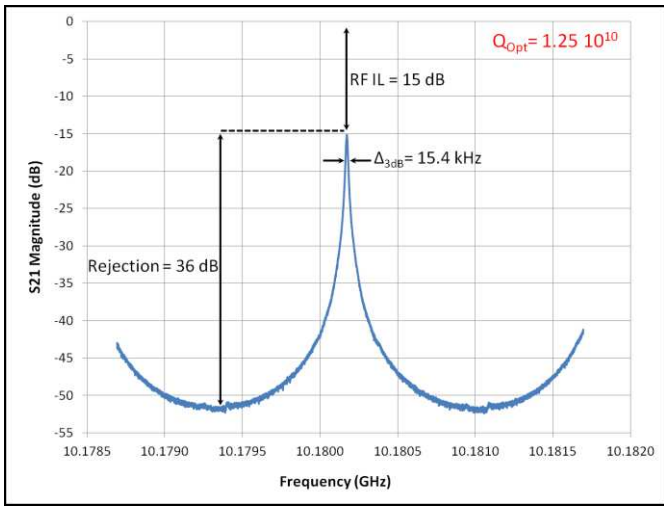

Figure 4 : Measurement of the transmission response near 10.2 GHz of the 120 m resonator, using the PDH lock and a frequency modulation approach (microwave network analyser).

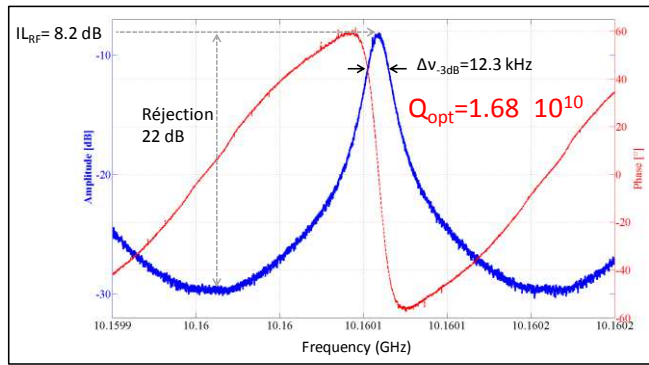

Figure 5 : Measurement of the transmission response of the 1000 m resonator, using the PDH lock and a frequency modulation approach (vector network analyser). The measured Q factor and IL are in this case identical to the ones simulated. The S_{21} phase response is also depicted in this figure.

The phase noise of the 120 FRR OEO is depicted in Figure 6. As shown in the figure, a sudden increase of the noise is observed inside the resonator half bandwidth. We were expecting such a phenomenon, because this resonator is not protected against optical nonlinear effects, and the intra cavity power enhancement factor is huge. We have attempted to reduce its influence by reducing the resonator optical input power, but the best phase noise level we could get with the PDH locking still going on was -40 dBc/Hz @ 10 Hz, which has to be compared to the -52 dBc/Hz @ 10 Hz obtained with the preceding 100 m FRR with a Q factor 6 times lower (but made of PM fiber and including an isolator).

We were more confident in the 1000 m FRR OEO, because of the isolator in the loop, but once again a sudden increase of the noise is observed inside the resonator half bandwidth, has shown in Figure 7. Also shown in this figure is the effect of a reduction of the resonator input power : the changes observed in the carrier to noise ratio outside the resonator bandwidth are proportional to this power, but the phase noise improvement inside the cavity is not (but there is effectively an improvement at low power). The FSR for this resonator is also very small :

200 kHz, which means that the dielectric resonator filter is no more sufficient to filter only one resonant mode. However, at low optical power, we still were able to get a single oscillation, even if the lateral modes can be seen on the spectra every 200 kHz offset.

For this 1000 m FRR OEO, the best phase noise results is -27 dBc/Hz @ 10 Hz and -105 dBc/Hz @ 10 kHz, which is still far from the best result described in section II. The reason may lie in two points : either the 1000 m section between two isolators is too large to prevent the built up of Rayleigh scattering noise, or a polarization noise is predominant because conventional SMF fiber has been used in this design instead of PM fiber (because of the cost of 1000 m PM fiber).

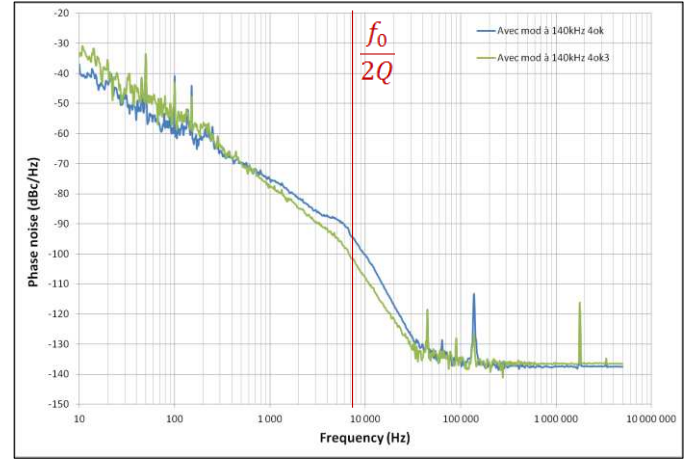

Figure 6 : Phase noise of the 10.2 GHz OEO based on the 120 m resonator ($Q = 1.25 \cdot 10^{10}$). The two curves correspond to two different loop parameters. A large increase of the noise is clearly seen inside the resonator half bandwidth.

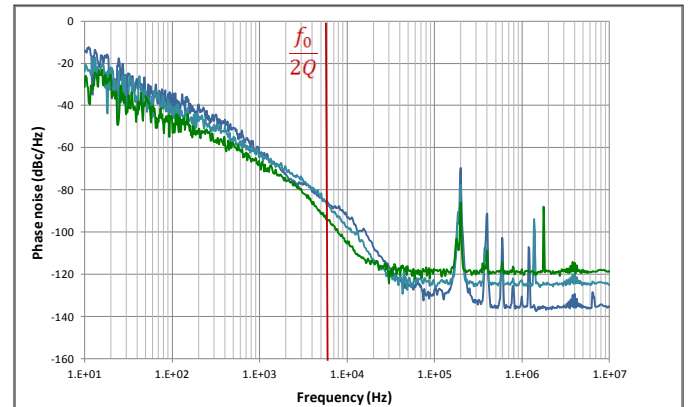

Figure 7 : Phase noise of the 10.2 GHz OEO based on the 1000 m resonator ($Q = 1.7 \cdot 10^{10}$). Again, a large increase of the noise is clearly seen inside the resonator half bandwidth, in spite of an attempt of reducing the intra cavity power (the three spectra presented correspond to different optical power levels at the resonator input).

V. CONCLUSION

Optical resonators with Q factor in excess of 10^{10} have been successfully designed and realized using the fiber ring resonator approach. The stabilization of a laser on one resonance has been demonstrated, using the Pound Drever Hall

technique. The measurement of the resonators characteristics have thus been performed thanks to a microwave modulation and a vector network analyser. The measured data (Q factor, insertion losses, out of band rejection...) are very close to the simulated data for these ultra high Q resonators.

OEOs have then been realized with these two resonators and an approach based on the PDH laser stabilization on the resonator. The measured phase noise spectra show a sudden increase of the noise inside the resonator half bandwidth, which is the signature of a noise induced by the resonator itself.

Further studies will try to cancel this parasitic noise contribution, and also to improve the performance of the best OEO realized up to now, which was based on a $2 \cdot 10^9$ Q factor resonator.

ACKNOWLEDGMENT

This study is sponsored by the French National Space Centre (CNES) and the "Direction Générale de l'Armement" (DGA), French MoD procurement agency, under the contract ANR-11-ASTR-0029 MINOTOR.

REFERENCES

- [1] X.S. Yao, L. Maleki, "High frequency optical subcarrier generator," *Electronics Letters*, vol. 30, Issue 18, pp. 1525-1526, Sept. 1994.
- [2] X.S. Yao, D. Eliyahu, L. Maleki, "Progress in the optoelectronic oscillator – a ten year anniversary review," *IEEE Microwave Theory and Tech. Symp. Digest*, vol. 1, pp. 287-290, Jun. 2004.
- [3] A. A. Savchenkov, E. Rubiola, A. B. Matsko, V. S. Ilchenko, L. Maleki, "Phase noise of whispering gallery photonic hyper-parametric microwave oscillators", *Optics Express*, March 2008, Vol. 16, No. 6, pp. 4130-4144.
- [4] V. S. Ilchenko, J. Byrd, A. A. Savchenkov, A. B. Matsko, D. Seidel, L. Maleki, "Miniature Oscillators Based on Optical Whispering Gallery Mode Resonators", *Proc. of the 2008 IEEE Int. Freq. Control Symp.*, pp. 305-308.
- [5] P.-H. Merrer, K. Saleh, O. Llopis, S. Berneschi, F. Cosi, G. Nunzi Conti, "Characterization technique of optical whispering gallery mode resonators in the microwave frequency domain for optoelectronic oscillators", *Applied Optics*, Vol. 51, Issue 20, pp. 4742-4748, July 2012.
- [6] P. H. Merrer, A. Bouchier, H. Brahimi, O. Llopis, and G. Cibiel, "High-Q Optical Resonators for Stabilization of High Spectral Purity Microwave Oscillators", *proc. of the 2009 IEEE EFTF-IFCS*, pp. 866-869, (2009).
- [7] K. Saleh, P.H. Merrer, O. Llopis, G. Cibiel, "Optoelectronic oscillator based on fiber ring resonator: overall system optimization and phase noise reduction", *2012 IEEE International Frequency Control Symposium (IFCS)*, 21-24 may 2012.
- [8] X. S. Yao, L. Davis, L. Maleki, "Coupled optoelectronic oscillators for generating both RF signal and optical pulses", *Journal of Lightwave Technology*, Vol. 18, Issue 1, Jan. 2000, pp. 73 – 78.
- [9] N. Yu, E. Salik, L. Maleki, "Ultralow-noise mode-locked laser with coupled optoelectronic oscillator configuration", *Optics Letters*, May 2005, pp. 1231-1233.
- [10] K. Saleh, O. Llopis, G. Cibiel, "Optical Scattering Induced Noise in Fiber Ring Resonators and Optoelectronic Oscillators", *Journal of Lightwave Technology*, vol. 31, no. 9, pp. 1433,1446, May 1, 2013.