



HAL
open science

Electrochemical performances of vitreous materials in the system $\text{Li}_2\text{O}-\text{V}_2\text{O}_5-\text{P}_2\text{O}_5$ as electrode for lithium batteries

Gaëlle Delaizir, V. Seznec, Patrick Rozier, C. Surcin, Philippe Salles, Mickaël Dollé

► **To cite this version:**

Gaëlle Delaizir, V. Seznec, Patrick Rozier, C. Surcin, Philippe Salles, et al.. Electrochemical performances of vitreous materials in the system $\text{Li}_2\text{O}-\text{V}_2\text{O}_5-\text{P}_2\text{O}_5$ as electrode for lithium batteries. *Solid State Ionics*, 2013, 237, pp.22-27. <10.1016/j.ssi.2013.02.006>. <hal-00908853>

HAL Id: hal-00908853

<https://hal.science/hal-00908853v1>

Submitted on 21 Oct 2019

HAL is a multi-disciplinary open access archive for the deposit and dissemination of scientific research documents, whether they are published or not. The documents may come from teaching and research institutions in France or abroad, or from public or private research centers.

L'archive ouverte pluridisciplinaire **HAL**, est destinée au dépôt et à la diffusion de documents scientifiques de niveau recherche, publiés ou non, émanant des établissements d'enseignement et de recherche français ou étrangers, des laboratoires publics ou privés.



HAL Authorization



Open Archive Toulouse Archive Ouverte (OATAO)

OATAO is an open access repository that collects the work of Toulouse researchers and makes it freely available over the web where possible

This is an author's version published in: <http://oatao.univ-toulouse.fr/24437>

Official URL: <https://doi.org/10.1016/j.ssi.2013.02.006>

To cite this version:

Delaizir, Gaëlle and Seznec, Vincent and Rozier, Patrick  and Surcin, Christine and Salles, Philippe and Dollé, Mickael *Electrochemical performances of vitreous materials in the system Li₂O–V₂O₅–P₂O₅ as electrode for lithium batteries*. (2013) *Solid State Ionics*, 237. 22-27. ISSN 0167-2738

Any correspondence concerning this service should be sent to the repository administrator: tech-oatao@listes-diff.inp-toulouse.fr

Electrochemical performances of vitreous materials in the system $\text{Li}_2\text{O}-\text{V}_2\text{O}_5-\text{P}_2\text{O}_5$ as electrode for lithium batteries

G. Delaizir ^a, V. Seznec ^b, P. Rozier ^c, C. Surcin ^b, P. Salles ^c, M. Dollé ^{c,*}

^a Sciences des Procédés Céramiques et de Traitements de Surface, SPCTS UMR CNRS 7315, Centre Européen de la Céramique, 12 rue Atlantis, 87068 Limoges, France

^b Laboratoire de réactivité et chimie des solides (LRCS), Université de Picardie Jules-Verne, 33 rue Saint-Leu, 80039 Amiens, France

^c Centre d'Elaboration des Matériaux et d'Etudes Structurales, CEMES-CNRS, UPR 8011, 29 rue Jeanne Marvig, BP 94347, 31055 Toulouse cedex 4, France

ARTICLE INFO

Keywords:

Oxide glasses

Synthesis

Electrical properties

Electrochemistry

ABSTRACT

Glass composition $25\text{Li}_2\text{O} \cdot 50\text{V}_2\text{O}_5 \cdot 25\text{P}_2\text{O}_5$ has been investigated as a potential material for electrode. Electrical properties as well as electrochemical performances of this glass composition have been characterized and results show a capacity less than 80 mAh g^{-1} when tested in the [3–4.5 V] potential window. To the best of our knowledge, this is the first lithiated amorphous material reported as a potential positive electrode material. Glasses, due to their wide available compositions in a given system and their easy processing, pave the way to new type of electrode material.

1. Introduction

The materials investigated to find new suitable intercalation host structures for applications in Li or Li ion batteries are essentially crystalline materials. Glass compositions have also been investigated as potential electrode material but mainly as solid electrolyte essentially for all solid state batteries in the 80's [1–4] and, as shown by papers in the last 10 years, these glassy materials are still under interest [5–9]. Only few glass systems have been investigated for their potentiality as positive electrode material among which we can cite the $\text{V}_2\text{O}_5 \cdot \text{P}_2\text{O}_5$ system which exhibits high capacity and a good reversibility [10] or the $\text{TeO}_2 \cdot \text{V}_2\text{O}_5$ system [1]. To the best of our knowledge most of ternary glasses including lithium have been studied essentially for their electronic/ionic conductivity like in many oxide glasses such as $\text{Li}_2\text{O} \cdot \text{B}_2\text{O}_3 \cdot \text{V}_2\text{O}_5$ [11], $\text{Li}_2\text{O} \cdot \text{MoO}_3 \cdot \text{P}_2\text{O}_5$ [12], $\text{Li}_2\text{O} \cdot \text{V}_2\text{O}_5 \cdot \text{TeO}_2$ [13] or in chalcogenide glasses [14]. These studies have been more recently extended to the glass ceramics and on the effect of nano crystallization on the conductivity [15,16]. However, they have never been tested as electrode material.

In our study, the $\text{Li}_2\text{O} \cdot \text{P}_2\text{O}_5 \cdot \text{V}_2\text{O}_5$ ternary system has been selected as possible electrode materials for rechargeable lithium batteries. This ternary system exhibits a large vitreous domain leading to a wide choice of glass compositions [15] allowing, once understood, the relationship structure properties to adjust their composition to optimize the desired properties. Despite taking place in air, during the synthesis, a spontaneous reduction of V^{5+} down to V^{4+} is observed leading to samples

including both Li^+ and V^{4+} ions. Therefore, some electrochemical activity in charge can be expected. Moreover these samples exhibit mixed ionic/electronic conductivity [17] the former occurring via transport of Li^+ while the latter consists in the electron hopping between V^{4+} and V^{5+} centers. Some studies [18] have revealed that the conductivity switches from mainly electronic for high vanadium content samples to mainly ionic for high lithium content samples. Intermediate compositions correspond to mixed electronic/ionic conductivity. Then, to combine both possibilities of lithium extraction via V^{4+} oxidation and the advantage of mixed conductivity, the special composition $25\text{Li}_2\text{O} \cdot 50\text{V}_2\text{O}_5 \cdot 25\text{P}_2\text{O}_5$ has been selected to investigate the electrochemical properties of such this glass. Samples are prepared and their thermal behavior as well as electrical properties has been determined. Electrochemical behavior both in oxidation and reduction modes are investigated while soft chemistry routes are used to mimic fully oxidized and reduced samples. The interpretation of all the different results confirms the potentiality of such ternary glasses as possible candidate for electrode materials in Li ion batteries.

2. Experimental

2.1. Glass synthesis

Glass composition $25\text{Li}_2\text{O} \cdot 50\text{V}_2\text{O}_5 \cdot 25\text{P}_2\text{O}_5$ (molar fraction) is prepared by mixing in a mortar a batch of 2 g of appropriate amount of commercially Li_2CO_3 (Alfa Aesar, 98%), $(\text{NH}_4)_2\text{HPO}_4$ (Merck, 98%) and V_2O_5 (Aldrich, 99.6%). The precursors are heated at 400°C in a platinum crucible to decompose the carbonate and the di ammonium hydrogen phosphate. The product is then mixed again for a better homogenization

* Corresponding author.

E-mail address: mickael.dolle@cemes.fr (M. Dollé).

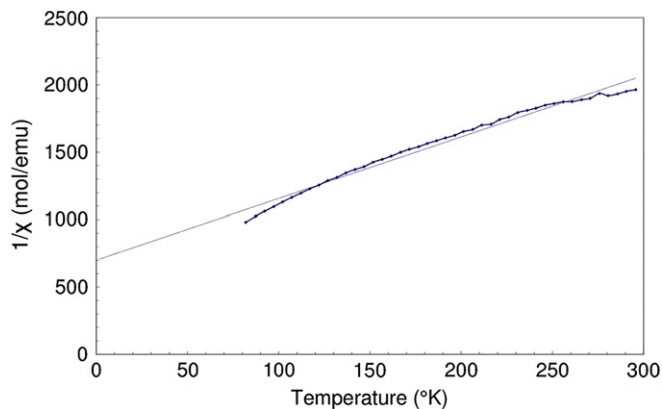

Fig. 1. The thermal variation of the inverse magnetic susceptibility in the 25Li₂O-50V₂O₅-25P₂O₅ glass composition measured with a field of 7600 G. The dashed line represents the Curie-Weiss law.

and the temperature is increased to 900 °C for melting. The melt is kept for 1 h at this temperature and then quenched between two stainless steel plates to obtain glassy sample. For conductivity measurements, samples are molded in a circular shape and annealed 1 h at T_g 10 °C to remove the mechanical stress occurring during quenching. The temperature is then decreased slowly to room temperature. The chemical composition of the glass after synthesis is checked by microprobe SX 100 CAMECA. Thin platinum layer are then pasted on each face of pellets to ensure good electrical contact.

2.2. Physical measurements

Thermal characteristics of the glass (glass transition temperature, T_g and crystallization temperature, T_c) are determined using a DSC Mettler equipment (heating rate: 10 °C/min).

XRD patterns have been recorded using a D8 Bruker equipment in the range 10 55° (2θ). Ex situ measurements on charged/discharged materials have been performed using a cell with Be window.

Impedance measurements are performed in the range of temperature 300 K 470 K under helium using a HP4192A Impedance Analyzer working in the frequency range 5 5 × 10⁶ Hz. Prior to the measurements, a Pt layer is deposited on each side of the glass bulk.

The influence of ball milling on the glass particle size have been observed using Scanning Electron Microscopy (FEG SEM JEOL 7400 F).

The presence of mixed valence is determined according to the magnetic susceptibility experiment based on the Faraday's method in the range of temperature 73 K 300 K.

2.3. Electrochemical tests

For electrochemical tests, the 25Li₂O 50V₂O₅ 25P₂O₅ glass is ground with 15%wt of SP carbon (Black carbon from MM, Belgium) in a planetary ball mill (Fritsch) for 2 h using tungsten carbide (WC) bowl and balls. The mixture (7 10 mg) is used as positive electrode and placed in a Swagelok™ cell using a Whatman GF/D borosilicate glass fiber sheet saturated with a 1 M LiPF₆ electrolyte solution in 1:1 dimethyl carbonate (DMC)/ethylene carbonate (EC) and a Li foil as negative electrode. Electrochemical characterizations are carried out in galvanostatic mode using VMP 2 multichannel potentiostat/galvanostat (Biologic Co, Claix, France). A cycling rate of C/10 (1 lithium in 10 h) is used. In potential composition curves, x corresponds to the number of moles of Li involved in the discharge/charge of the electrode.

Chemical extraction or lithiation of 25Li₂O 50V₂O₅ 25P₂O₅ glass are performed to mimic the electrochemical oxidation or reduction process. One mole lithium is extracted from the pristine glass by

using 1 M NO₂BF₄ acetonitrile solution as the oxidizing agent; the NO₂⁺/NO₂ couple being the active redox couple, while the BF₄⁻ ions solely act as spectators. Up to six moles of lithium are inserted in the pristine glass by using butyllithium (C₄H₉Li) in cyclohexane as the reducing agent. The experiments are conducted at 80 °C in an argon dry box by placing in a glass vessel 0.5 g of glass and pouring the exact amount of oxidizing or reducing agent. The solutions are stirred for 48 h.

3. Results and discussion

3.1. Magnetic measurements

The magnetic susceptibility χ (T) is measured in a field of 7600 G in the temperature range 80 300 K. The thermal variation of 1/χ (Fig. 1) follows a Curie Weiss law with a paramagnetic Curie temperature θ_p ≈ -153 K. The magnetic measurements (Faraday balance) show a mixed valence V⁴⁺/V⁵⁺ for the 25Li₂O 50V₂O₅ 25P₂O₅ glass composition. The total Curie constant, C_t, is calculated from the relationship χ = C_t/T with T, the temperature in °K. At 295 K under 7600 G, the total Curie constant, C_t is equal to 0.151. The Curie constant of V⁴⁺ is 0.375 which leads to an amount (atomic %) of V⁴⁺ of about 40% in the 25Li₂O 50V₂O₅ 25P₂O₅ composition. Thus, this composition can be written as following Li₂(V⁴⁺_{0.4}V⁵⁺_{0.6})₄P₂O_{15.2} and more generally as

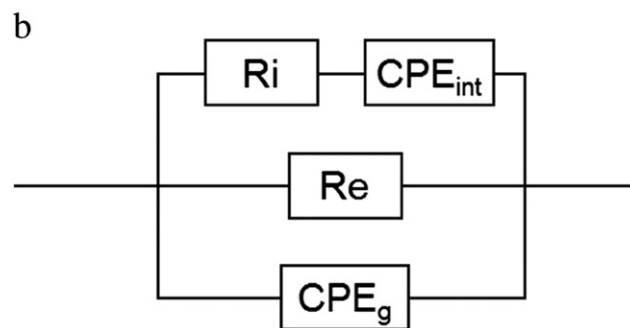
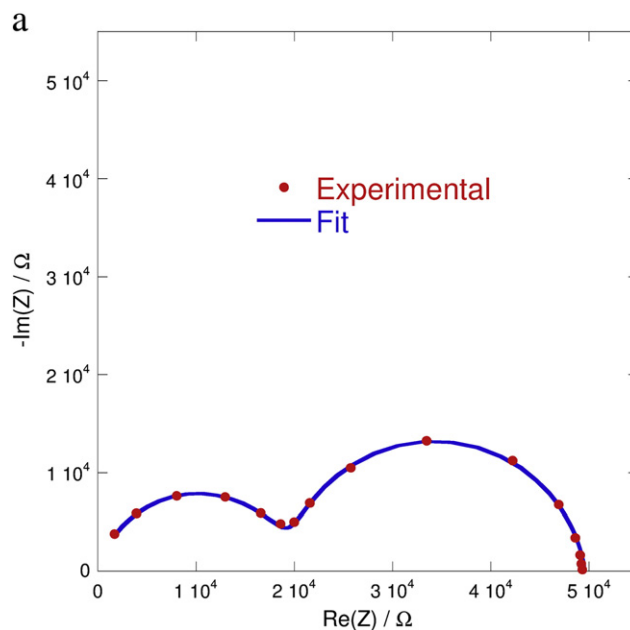

Fig. 2. (a) Impedance measurements of glass bulk composition 25Li₂O-50V₂O₅-25P₂O₅: experimental data and fit taking into consideration the Weppner model [20], (b) Maxwell's equivalent circuit.

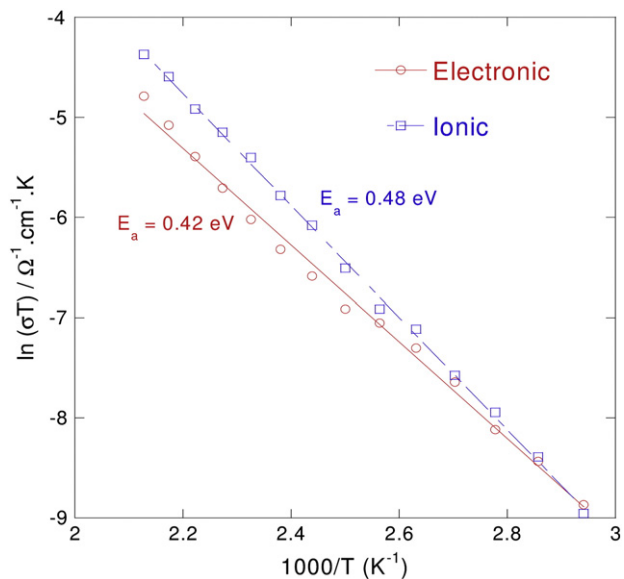

Fig. 3. Arrhenius plots of electrical (ionic and electronic) conductivity of glass bulk composition 25Li₂O-50V₂O₅-25P₂O₅.

Li₂(V⁴⁺_yV⁵⁺_{1-y})₄P₂O_{16-2y} to take into account the charge compensation due to vanadium spontaneous reduction. Microprobe analysis confirms the homogeneity of the glass and the ratio V/P. To be more precise, our glass therefore belongs to the quaternary system Li₂O V₂O₅ V₂O₄ P₂O₅.

3.2. Electrical measurements

An example of the results of the AC measurements is shown in Fig. 2a. The Nyquist plots may be decomposed into two semicircles in the mid and high frequencies domain, while there is only a single point on the real axis at the low frequency end. Such diagram is characteristic of a mixed ionic/electronic conductor and it may be represented by the Maxwell's equivalent circuit as reported in Fig. 2b [19 21]. In this circuit, R_e corresponds to the electronic resistance, R_i is the ionic resistance, C_g is the geometrical capacitance, and C_{int} is the interfacial capacitance associated to the ionically blocking Pt electrodes (which is shunted by the electronic current at low frequencies). The non linear least squares fitting program Equivcrt [22] was used to fit the experimental data with this equivalent circuit. The comparison between experimental and fitting data using the Weppner model is reported in Fig. 2a. The R_e and R_i values obtained at each temperature were used to calculate the electronic and ionic conductivity and the corresponding Arrhenius plots are shown in Fig. 3. The results confirm that the base glass composition 25Li₂O 50V₂O₅ 25P₂O₅ is a mixed electronic/ionic conductor with activation energy of 0.42 eV and 0.48 eV for the electronic and ionic contributions respectively. These values are in good agreement with previously published data on the same composition [18]. However, the extrapolation at room temperature indicates the ionic and electronic conductivities are relatively low about 5 × 10⁻⁸ S.cm⁻¹, which will be a drawback for the electrochemical performances of this glass. It then appears necessary to optimize the electronic conductivity of the electrode by a homogeneous mixing with carbon black, while small particles size would allow circumventing the low ionic conductivity.

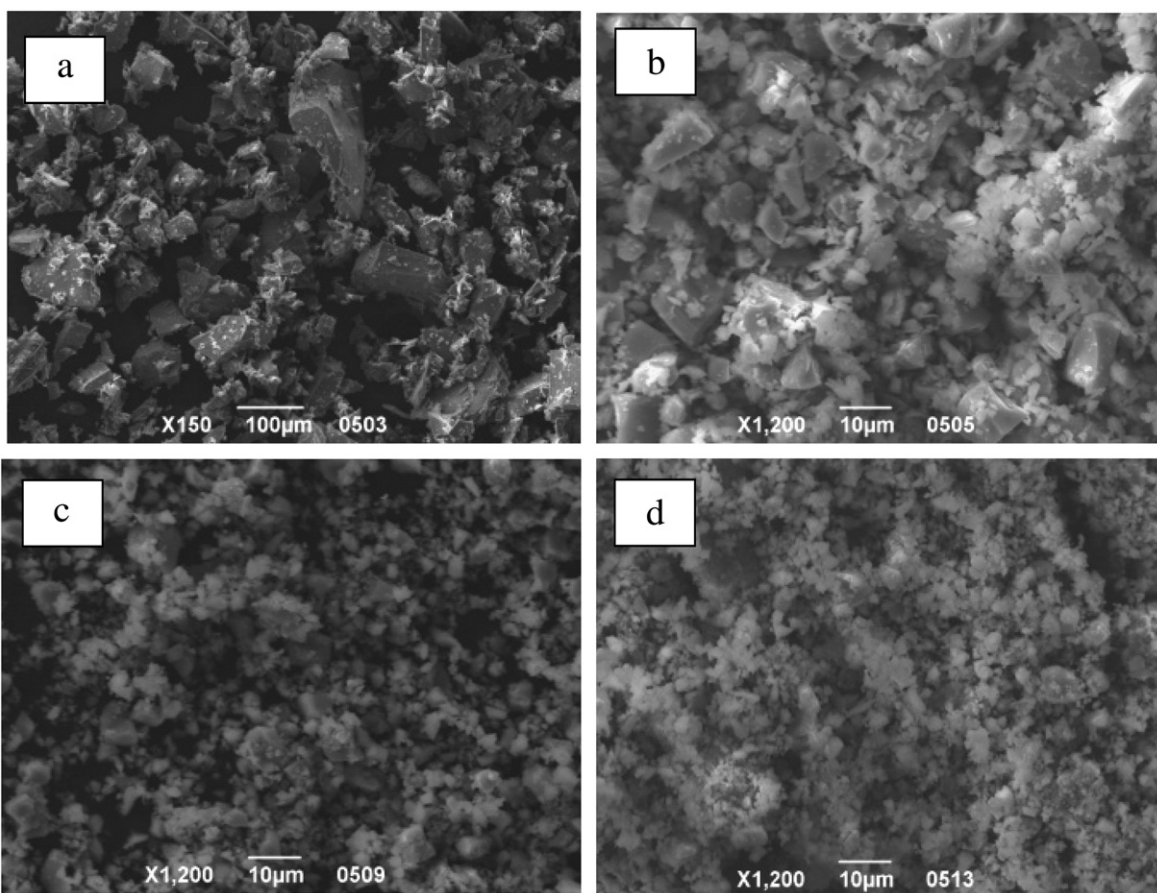

Fig. 4. SEM pictures of the 25Li₂O-50V₂O₅-25P₂O₅ glass composition (a) after hand grinding (b) 30 min planetary ball milling (tungsten carbide jars) (c) 1 h planetary ball milling (tungsten carbide jars) (d) 2 h planetary ball milling (tungsten carbide jars).

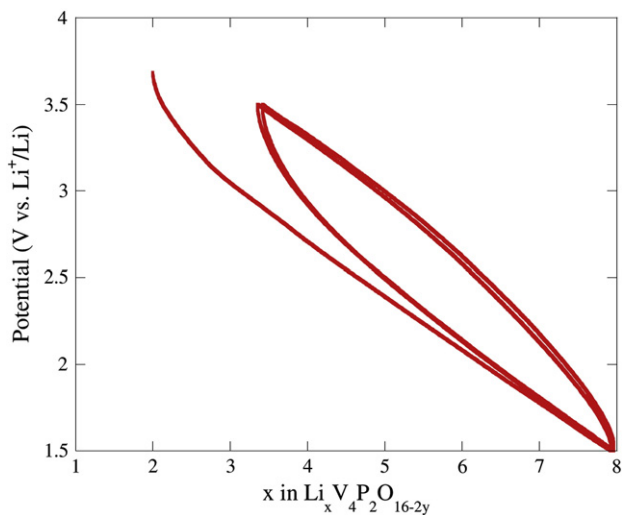

Fig. 5. Galvanostatic charge/discharge curves of the $25\text{Li}_2\text{O}-50\text{V}_2\text{O}_5-25\text{P}_2\text{O}_5$ glass composition + 15%wt C for a voltage window [1.5-3.5 V].

3.3. Electrochemical performances of the $25\text{Li}_2\text{O}-50\text{V}_2\text{O}_5-25\text{P}_2\text{O}_5$ glass ($\text{Li}_2\text{V}_4\text{P}_2\text{O}_{15.2}$)

Glass pieces are first hand ground in an agate mortar to obtain glass powder (Fig. 4a). Then ball milling is performed on this powder under argon using tungsten carbide (WC) bowl and balls. The SEM pictures revealed after 30 min very big particle size ($> 10 \mu\text{m}$) as well as an inhomogeneous particle size distribution (Fig. 4b). After 1 or 2 h ball milling, the particle size distribution becomes homogeneous and the mean particle size is less than $3 \mu\text{m}$ (Figs. 4c, 4d). The glass is then mixed with 15%wt. of Carbon SP (Timcal) in a ball milling equipment and tested electrochemically in Swagelok™ type cells against Li metal with 1 M LiPF_6 electrolyte solution in 1:1 (w/w) of dimethyl carbonate/ethylene carbonate. A VMP2 automatic cycling/data recording system (Biologic SA, Claix, France) operating in galvanostatic mode at C/10 regime, is used for the electrochemical experiments. The glass is tested at low potential in the voltage window [1.5–3.5 V] and at high potential in the voltage window [3–4.5 V].

Fig. 5 shows the galvanostatic charge/discharge curves of the first three cycles of the glassy electrode with the cut off voltage 1.5–3.5 V. The capacity reaches $320 \text{mAh}\cdot\text{g}^{-1}$ upon the first discharge with an uptake of six lithium per formula unit, leading to a material with almost all the vanadium in the +3 oxidation state. These results are in good agreement with the ones previously obtained on amorphous $\text{V}_2\text{O}_5-\text{P}_2\text{O}_5$ electrode discharged down to 1.5 V vs Li^+/Li [23]. The first charge up to 3.5 V is associated to the extraction of only 4.6 Li per formula unit, which are then reversibly exchanged during the cycles leading to a capacity of $245 \text{mAh}\cdot\text{g}^{-1}$. The specific shape of the voltage composition curve indicates, as usually observed for amorphous samples (structural randomness), that no drastic structural changes occur even for large intercalation ratios [24].

Fig. 6a shows the galvanostatic charge/discharge curves of the glassy electrode with the cut off voltage 3.0–4.5 V.

Upon the first oxidation up to 4.5 V, about 1 lithium ion is removed from the glass while an uptake of 1.5 lithium ions is observed in the following discharge down to 3 V against Li metal. The lithium removal/uptake is maintained constant upon the following cycles with an associated discharge capacity of about $72 \text{mAh}\cdot\text{g}^{-1}$ at an average potential of 3.7 V (Fig. 6b).

To mimic the glass behavior in the charged as well as in the discharged state, chemical extraction or lithiation has been performed on the glass powder. As mentioned in the literature [15], the composition $25\text{Li}_2\text{O}-50\text{V}_2\text{O}_5-25\text{P}_2\text{O}_5$ is amorphous. To confirm the total amorphous state of the extracted powder which is of interest

in this study, ex situ XRD measurements were performed on the initial glass powder and after a charge at 5 V. The results are shown in Fig. 7b. No difference in diffraction patterns is observed between the two powders, which confirm the material remains glassy in the charged state. It is noteworthy that the observed peaks correspond to the Al coated Be window from the ex situ XRD cell (black arrows).

Glass transition temperature T_g and crystallization temperature T_c of the base glass and the chemically extracted/lithiated powder have been determined by DSC measurements (Fig. 7a). The $25\text{Li}_2\text{O}-50\text{V}_2\text{O}_5-25\text{P}_2\text{O}_5$ composition has a glass transition temperature of $T_g=285 \text{ }^\circ\text{C}$ and a crystallization temperature of $T_c=385 \text{ }^\circ\text{C}$. The chemically extracted and lithiated powders also shows a glass transition temperature indicating the presence of a glassy phase. The difference $\Delta T=T_c-T_g$ equal or more than $100 \text{ }^\circ\text{C}$ is a good criterion to define the glass stability (Hruby's criterion). During lithiation and delithiation, we respectively observe a ΔT of $75 \text{ }^\circ\text{C}$ and $169 \text{ }^\circ\text{C}$, ΔT being equal to $100 \text{ }^\circ\text{C}$ for the pristine glass. Therefore the lithiation phenomenon destabilizes the glass whereas the delithiation seems to stabilize the glass toward the crystallization phenomenon. As previously mentioned, our glass is located in the $\text{Li}_2\text{O}-\text{V}_2\text{O}_5-\text{V}_2\text{O}_4-\text{P}_2\text{O}_5$ quaternary system. It is noteworthy that V_2O_5 like P_2O_5 was considered as a possible glass former by Zachariasen [25]. Depending of

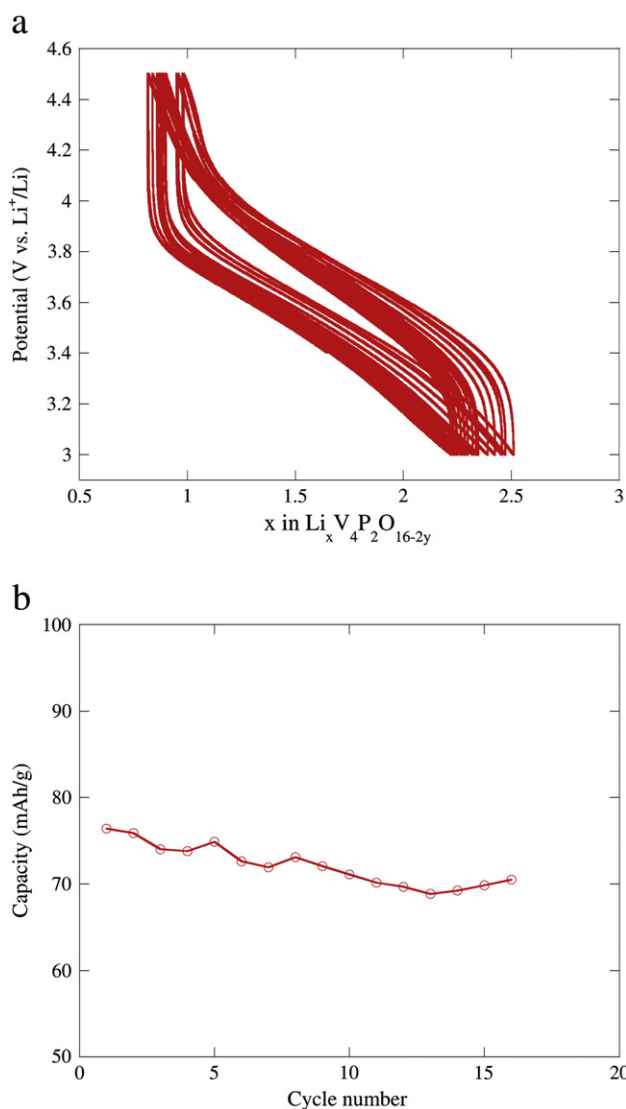

Fig. 6. (a) Galvanostatic charge/discharge curves of the $25\text{Li}_2\text{O}-50\text{V}_2\text{O}_5-25\text{P}_2\text{O}_5$ glass composition + 15%wt C for a voltage window [3-4.5 V], (b) Corresponding discharge capacity versus the cycle number of the cell.

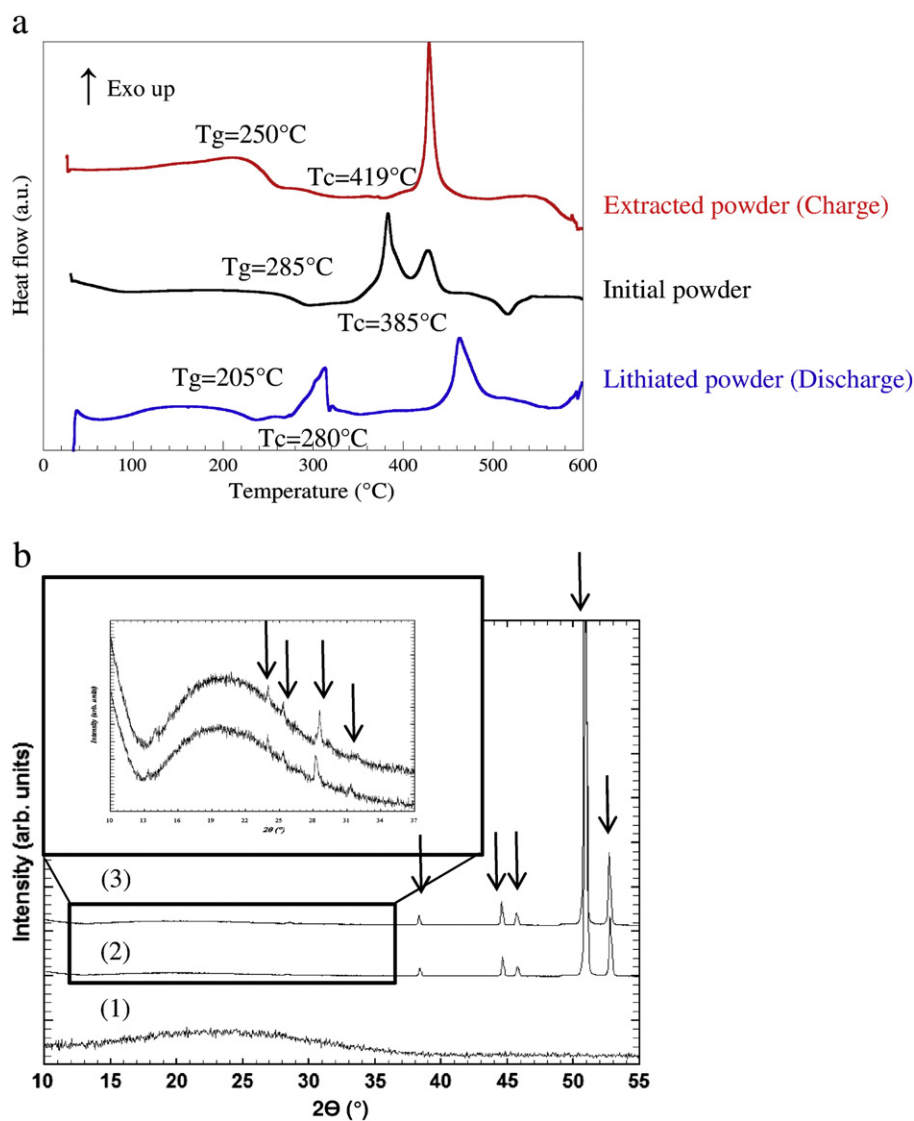

Fig. 7. (a) DSC measurements of the glass composition $25\text{Li}_2\text{O}-50\text{V}_2\text{O}_5-25\text{P}_2\text{O}_5$ and the chemically extracted (charged) and lithiated (discharged) glass. Glass transition temperature T_g and crystallization temperature T_c of the initial base glass $25\text{Li}_2\text{O}-50\text{V}_2\text{O}_5-25\text{P}_2\text{O}_5$ and the chemically extracted and inserted glass (DSC measurements) are mentioned by an arrow. (b) (1) Initial $25\text{Li}_2\text{O}-50\text{V}_2\text{O}_5-25\text{P}_2\text{O}_5$ glass powder, ex-situ XRD measurements of the initial $25\text{Li}_2\text{O}-50\text{V}_2\text{O}_5-25\text{P}_2\text{O}_5$ glass powder (2) and the same powder charged at 5 V (3). Diffraction peaks mentioned by an arrow correspond to the Al coated Be window.

the discharge depth, the insertion of Li into the glass tends to modify its composition toward the $\text{Li}_2\text{O}-\text{V}_2\text{O}_4/\text{V}_2\text{O}_3-\text{P}_2\text{O}_5$ system. The increase of Li amount in the glass, as well as the increase of V_2O_4 (or V_2O_3), are known to destabilize the glass network. On the contrary, upon charge, we move to the ternary $\text{Li}_2\text{O}-\text{V}_2\text{O}_5-\text{P}_2\text{O}_5$ system, with a decrease of Li content and the increase of V_2O_5 , which will stabilize the glasses.

3.4. Discussion

As shown experimentally, the glass $25\text{Li}_2\text{O}-50\text{V}_2\text{O}_5-25\text{P}_2\text{O}_5$ exhibits interesting electrochemical properties when used at low potential, but also at high potential. While the use of non lithiated glassy electrodes as electrode material has already been investigated in the literature, the report of lithiated glassy material with electrochemical activities upon charge has, to our knowledge, not been widely considered. Moreover, it is difficult to find in the literature any crystalline oxophosphate compounds with a mixed valence ($\text{V}^{4+}/\text{V}^{5+}$) in the Li-V-P-O systems. Amongst the existing materials, LiVOPO_4 [26,27], $\text{Li}_4\text{VO}(\text{PO}_4)_2$ [28] or $\text{Li}_2\text{VOP}_2\text{O}_7$ [29] can be considered for comparison. These crystalline materials require a multi step synthesis (precipitation + carbothermal

reduction, preliminary chemical lithiation or ion exchange of hydrated or Na precursors). The obtained materials display electrochemical capacity from $30 \text{mAh}\cdot\text{g}^{-1}$ for $\text{Li}_2\text{VOP}_2\text{O}_7$, which presents an irreversible capacity associated to a structural modification to $70 \text{mAh}\cdot\text{g}^{-1}$ for $\text{Li}_4\text{VO}(\text{PO}_4)_2$ in presence of 50%wt of carbon, which is necessary to compensate the poor electronic conductivity of this material. Only β LiVOPO_4 displays a capacity of $135 \text{mAh}\cdot\text{g}^{-1}$ with some kinetic limitations and it requires cycling at low rates. It was shown how a small amount of V^{4+} in the α VOPO_4 increases its electronic conductivity and its electrochemical behavior [30]. The mixed valence of our glass plays an important role to guarantee the promising electrochemical performances. Such kind of glassy electrode materials offer many advantages, they are easy and fast to prepare with a large domain of existence, which allows modifying simply the chemical composition in comparison to crystalline phases. Moreover, the material remains glassy upon charge or discharge, with stabilization (large T_c T_g value) of the glass upon oxidation. The difference in glass transition temperatures between the initial base glass ($T_g=250^\circ\text{C}$) and the corresponding extracted glass ($T_g=285^\circ\text{C}$) is limited to only 35°C (Fig. 7a) showing limited changes in the glass structure [31]. This could explain the good cycling of this glass composition when tested at high potential. Indeed,

there exists a strong correlation between the glass structure and the corresponding electrochemical performances [23].

4. Conclusion

The glass composition $25\text{Li}_2\text{O}$ $50\text{V}_2\text{O}_5$ $25\text{P}_2\text{O}_5$ has been tested as electrode material. This glassy material exhibits stabilized cycling behavior over 15 cycles with a capacity of 75 mAh.g^{-1} when tested in the [3 4.5 V] potential windows. It is noteworthy that the glass remains amorphous upon cycling from 1.5 to 4.5 V. The ease and processing of glassy materials as well as the ability to modify slightly the composition without disturbing drastically the structure are great advantages over crystalline materials. Based on this preliminary study, the structure of this glass composition and other glasses in the Li_2O V_2O_5 V_2O_4 P_2O_5 system are now under investigation to select the optimized composition ensuring interesting electronic/ionic conductivities and a large content of lithium and vanadium to increase the capacity upon charge. Glass ceramics with the presence of nano crystals inside the glassy matrix are also under investigations to enhance the electronic properties.

Acknowledgements

Authors would like to thank V. Impens and A. Pellaroque for their contribution to this work and E. Leroy from ICMPE for microprobe analysis.

References

- [1] M. Levy, F. Rousseau, M.J. Duclot, *Solid State Ionics* 28–30 (1988) 736–738.
- [2] M. Levy, J.L. Souquet, *Mater. Chem. Phys.* 23 (1989) 171–188.
- [3] M. Menetrier, V. Levasseur, C. Delmas, J.F. Audebert, P. Hagenmuller, *Solid State Ionics* 14 (1984) 257–261.
- [4] D. Ravaine, *J. Non-Cryst. Solids* 38–39 (1980) 353–358.
- [5] F. Mizuno, A. Hayashi, K. Tadanaga, M. Tatsumisago, *Solid State Ionics* 177 (2006) 2721–2725.
- [6] K. Minami, A. Hayashi, S. Ujiie, M. Tatsumisago, *J. Non-Cryst. Solids* 356 (2010) 2670–2673.
- [7] T. Okada, T. Honma, T. Komatsu, *Mater. Res. Bull.* 45 (2010) 1443–1448.
- [8] M. Goswami, S.K. Deshpande, R. Kumar, G.P. Kothiyal, *J. Phys. Chem. Solids* 71 (2010) 739–744.
- [9] M. Duclot, J.L. Souquet, *J. Power Sources* 97–98 (2001) 610–615.
- [10] Y. Sakurai, J. Yamaki, *J. Electrochem. Soc.* 132 (1985) 512–513.
- [11] Y.-I. Lee, J.-H. Lee, S.-H. Hong, Y. Park, *Solid State Ionics* 175 (2004) 687–690.
- [12] L. Bih, M. El Omari, J.-M. Réaud, M. Haddad, D. Boudlich, A. Yacoubi, A. Nadiri, *Solid State Ionics* 132 (2000) 71–85.
- [13] P. Rozier, T. Dubois, P. Salles, *J. Non-Cryst. Solids* 311 (2002) 241–249.
- [14] Z. Nagamedianova, E. Sánchez, *Solid State Ionics* 177 (2006) 3259–3265.
- [15] H. Takahashi, T. Karasawa, T. Sakuma, J.E. Garbarczyk, *Solid State Ionics* 181 (2010) 27–32.
- [16] J.E. Garbarczyk, M. Wasiucione, P. Jozwiak, J.L. Nowinski, C.M. Julien, *Solid State Ionics* 180 (2009) 531–536.
- [17] P. Jozwiak, J.E. Garbarczyk, *Solid State Ionics* 176 (2005) 2163–2166.
- [18] J.E. Garbarczyk, M. Wasiucione, P. Jozwiak, L. Tykarski, J.L. Nowinski, *Solid State Ionics* 154–155 (2002) 367–373.
- [19] J.R. Macdonald, D.R. Franceschetti, in: J.R. Macdonald (Ed.), *Impedance Spectroscopy Emphasizing Solid Materials and Systems*, Wiley, New York, 1987, p. 98.
- [20] V. Thangadurai, R.A. Huggins, W. Weppner, *J. Power Sources* 108 (2002) 64–69.
- [21] M. Wasiucione, J.E. Garbarczyk, B. Wnetrzewski, P. Machowski, W. Jakubowski, *Solid State Ionics* 92 (1996) 155–160.
- [22] B.A. Boukamp, *Equivalent Circuit*, University of Twente, Department of Chemical Technology, 1989.
- [23] Y. Sakurai, J.-I. Yamaki, *J. Electrochem. Soc.* 135 (1988) 791–796.
- [24] V.I. Gavriljuk, *Tech. Phys.* 42 (1997) 121–123.
- [25] W.H. Zachariasen, *J. Am. Chem. Soc.* 54 (1932) 3841–3851.
- [26] J. Barker, M.Y. Saidi, J.L. Swoyer, *J. Electrochem. Soc.* 151 (2004) A796–A800.
- [27] J. Gaubicher, T. Le Mercier, Y. Chabre, J. Angenault, M. Quarton, *J. Electrochem. Soc.* 146 (1999) 4375–4379.
- [28] M. Satya Kishore, V. Pralong, V. Caignaert, U.V. Varadaraju, B. Raveau, *Electrochem. Commun.* 8 (2006) 1558–1562.
- [29] M. Satya Kishore, V. Pralong, V. Caignaert, U.V. Varadaraju, B. Raveau, *Solid State Ionics* 10 (2008) 1285–1291.
- [30] N. Dupré, J. Gaubicher, T. Le Mercier, G. Wallez, J. Angenault, M. Quarton, *Solid State Ionics* 140 (2001) 209–221.
- [31] A. Feltz, B. Hunger, *J. Non-Cryst. Solids* 72 (1985) 335–343.