



HAL
open science

A stereotaxic atlas and technique for nuclei of the diencephalon of rainbow trout (*Salmo gairdneri*)

Roland Billard, R.E. Peter, J.L. Barbrel, Anne-Marie Escaffre, Chantal Cauty

► **To cite this version:**

Roland Billard, R.E. Peter, J.L. Barbrel, Anne-Marie Escaffre, Chantal Cauty. A stereotaxic atlas and technique for nuclei of the diencephalon of rainbow trout (*Salmo gairdneri*). *Reproduction Nutrition Développement*, 1982, 22 (1A), pp.1-25. <10.1051/rnd:19820101>. <hal-00897932>

HAL Id: hal-00897932

<https://hal.science/hal-00897932v1>

Submitted on 11 May 2020

HAL is a multi-disciplinary open access archive for the deposit and dissemination of scientific research documents, whether they are published or not. The documents may come from teaching and research institutions in France or abroad, or from public or private research centers.

L'archive ouverte pluridisciplinaire **HAL**, est destinée au dépôt et à la diffusion de documents scientifiques de niveau recherche, publiés ou non, émanant des établissements d'enseignement et de recherche français ou étrangers, des laboratoires publics ou privés.



HAL Authorization

A stereotaxic atlas and technique for nuclei of the diencephalon of rainbow trout (*Salmo gairdneri*)

R. BILLARD, R.E. PETER (*)

with the technical assistance of J. L. BARBREL, Anne-Marie ESCAFFRE and Chantal CAUTY

*Laboratoire de Physiologie des Poissons, I.N.R.A.
78350 Jouy-en-Josas, France.*

() Department of Zoology, University of Alberta,
Edmonton, Alberta T6G 2E9, Canada.*

Summary. A stereotaxic apparatus and technique for electrode placement in diencephalic nuclei of sexually immature rainbow trout of 120-140 g body weight is described. An atlas of nuclei in the diencephalon is also presented.

Introduction.

A stereotaxic atlas and technique for forebrain nuclei of the goldfish *Carassius auratus* (Peter, 1970 ; Peter and Gill, 1975) and the killifish, *Fundulus heteroclitus* (Peter *et al.*, 1975) have previously been described. For these stereotaxic techniques specially designed head holders were developed to maintain the head of the fish rigid in a certain position, and zeroing was by a point on the exposed surface of the brain. These techniques have been successfully used in studies on neuroendocrinology and behaviour in goldfish (*e.g.* Peter, 1970, 1977 ; Billard and Peter, 1977 ; Peter and Paulencu, 1980) and killifish (Macey *et al.*, 1974). In other studies a modified mammalian stereotaxic apparatus has been used for implantation of electrodes in the exposed brain of several teleost species for stimulation or recording in behavioural studies (*e.g.*, Demski, 1978). The present study describes a stereotaxic atlas and technique for the diencephalon of rainbow trout (*Salmo gairdneri*) of 120-140 g body weight in which the classical approach of skull coordinates was used. During its development, this technique was used in neuroendocrine studies (Crim *et al.*, 1981) and it has been an essential tool for additional studies in progress (R. Billard, L. Crim, H. Goos and R. Peter, unpublished results).

Materials and methods.

The stereotaxic apparatus is illustrated in figures 1a, b. This stereotaxic technique is applicable to sexually immature rainbow trout of 130 ± 10 g. The head holder is a 3-point system of attachment, consisting of 2 orbital bars, one inserted on the upper rim of each orbital bone ring (fig. 1b), and a mouth bar against the roof of the mouth. The apparatus consists of a metal base plate supporting a vertical tube on which are fixed two horizontal bars (left horizontal bar shown in fig. 1a, both are shown in fig. 1b) that serve to support the head holder and electrode holder. Both horizontal bars are square and are mounted in such a manner that an edge is towards the base plate. The horizontal bars are marked with a mm scale. An orbital bar is fixed to the underside of each

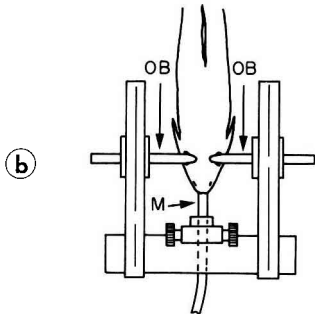
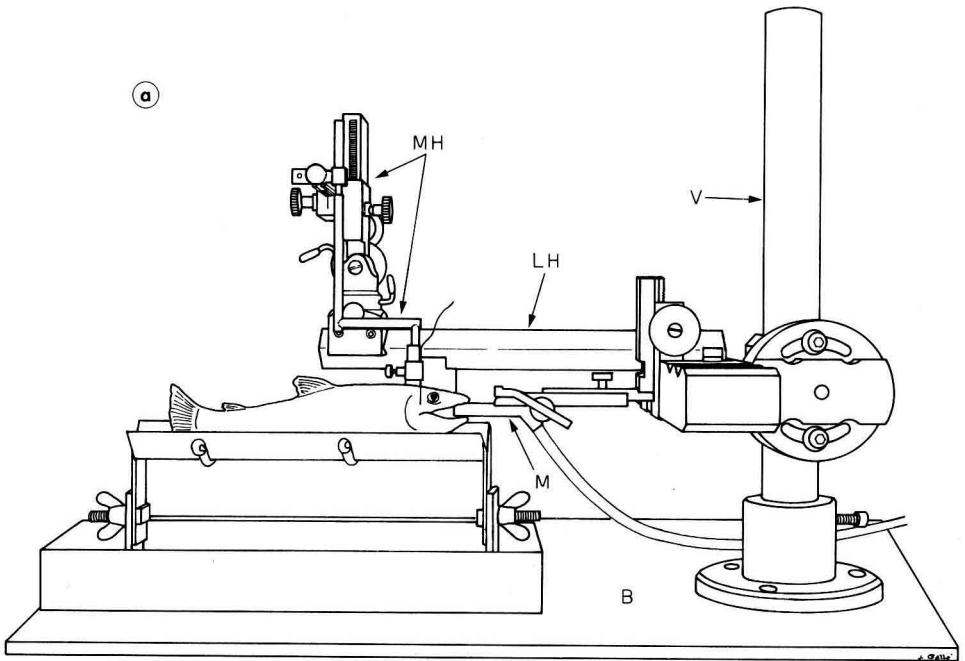

FIG. 1a. — Lateral view of the stereotaxic apparatus, shown without the right horizontal bar and right orbital bar. B, base plate; LH, left horizontal support bar; M, mouth bar; MH, micromanipulator with electrode holder; J, vertical support tube. FIG. 1b. — Dorsal view of a trout showing the orbital bars (OB) and mouth bar (M) in place.

horizontal bar equidistant from the main vertical support tube. The distal ends of the orbital bars are rectangular and can slide laterally in the clamps attached to the horizontal bars, allowing them to be clamped in any lateral position. The orbital bars and their respective clamps are marked with mm scales to allow clamping the bars in similar positions. The proximal end of each orbital bar is grooved according to the dimensions given in figure 2a. The upper surface of each orbital bar has a shallow groove (fig. 2b) that is used for zeroing (see below). The mouth bar is attached medially between the two horizontal bars to the same structure that supports the horizontal bars, and it can be moved vertically. For this technique the top of the mouth bar is set 7 mm below the top of the orbital bars and the tip of the mouth bar is 2.5 mm from the center of the orbital bars (fig. 2a, b) for each fish. The mouth bar is a hollow tube 10 mm in diameter (fig. 2a) and also serves as the inlet to the mouth for perfusion of the gills with anesthetic water. The electrode holder, in this apparatus a Narishige micromanipulator, is attached to a vertical rod that is itself attached to the left horizontal bar (fig. 1a). The three planes of operation of the electrode holder are squared to the horizontal and vertical planes of the head holder. The horizontal bar and the clamp attaching the electrode holder to it are marked with mm scales so that the electrode holder can be moved measured distances along the horizontal bar.

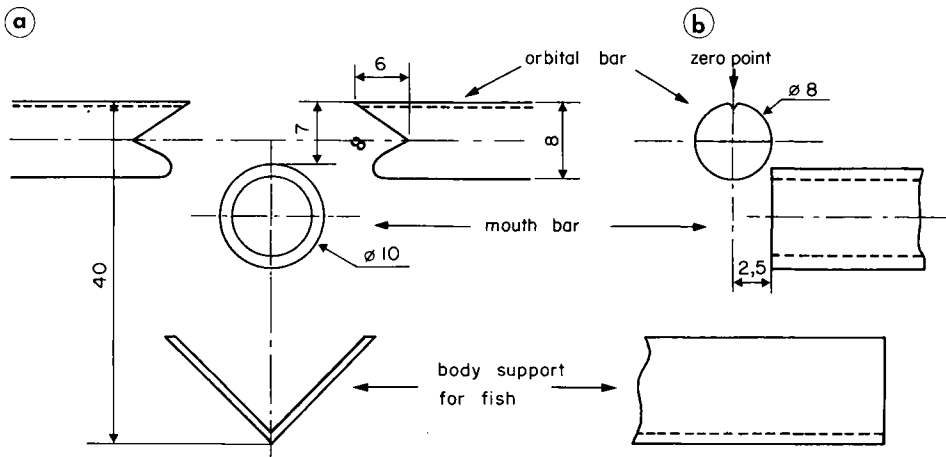

FIG. 2a. — Lateral view, to scale in mm, of the orbital bars and end views of the mouth bar and body support for the fish. 2b. — End view, to scale in mm, of an orbital bar and lateral view of the mouth bar and body support for the fish.

The fish, anesthetized in water containing 0.3-0.5 ml 2-phenoxyethanol/l, is supported by a V-shaped trough that sits inside a basin to collect the anesthetic water (fig. 1a). The mouth of the fish is centered over the mouth bar, and the orbital bars moved into position and clamped; the top of the skull should be approximately horizontal. The fish is perfused during the remainder of the

procedure with anesthetic water (0.3 ml 2-phenoxyethanol/l), which is recirculated and continuously aerated.

The horizontal and anterior-posterior zero (fig. 3) of the stereotaxic procedure is the shallow groove on the upper surface of the orbital bars (fig. 2b). The midline zero is the midpoint between the proximal ends of the orbital bars. After zeroing and noting the position of zero on the scales of the micromanipulator and the horizontal bar, the electrode is raised and moved posteriorly a measured distance, according to the atlas coordinates. For the final placement of the electrode, a hole big enough for it to pass is drilled in the skull, the electrode lowered to the horizontal zero position, and then down the appropriate vertical distance for placement in the desired position. After the electrode is withdrawn, the hole is filled with surgical wax and closed with a drop of cyanoacrylic glue. The fish is then removed from the apparatus and returned to anesthetic-free water for recovery.

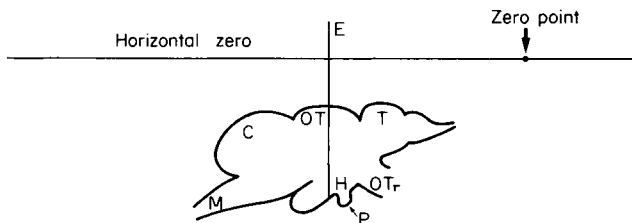

FIG. 3. — Outline drawing of a sagittal section of the trout brain showing the location of the zero point and the angle of intervention of an electrode (E) into the brain. C : cerebellum, H : hypothalamus, M : medulla, OT : optic tectum, OT_r : Optic tract, T : telencephalon.

Preparation of the atlas.

Ten sexually immature one year old rainbow trout, weighing 130 g after 3 days of starvation, were used. The fish were raised in earthen raceways and fed pelleted food twice daily. Each fish was placed on the stereotaxic apparatus, the top of the skull cut with a circular saw blade, and the brain exposed. In four of the fish, the brain was cross-sectioned at the level of the cerebellum using a razor blade attached to the electrode holder, and the anterior portion of the brain removed, with the pituitary attached, and fixed in Bouin's solution for 3 days. At embedding, the cerebellum section of the brain was placed against the bottom of the paraffin cup, and the angle of the cerebellum cross-section used as the guide for the angle for cutting sections in the same vertical plane as the electrodes in the stereotaxic apparatus (fig. 3). The other approach used was to leave electrodes in place in the brain during fixation, and use the electrodes as a guide for the plane of sectioning. After embedding, the top of two of these brains were cut off (horizontally cut) at a right angle to the plane of the electrodes, and then frontal sections were cut in the plane of the electrodes to enable correct vertical positioning of the sections relative to each other. Sections were cut at 8 μ m and stained with Epple's technique (1967). Pictures were taken of sections at intervals every 0.5, 0.1 or 0.2 mm, and drawings made of selected sections. Tissue

shrinkage of 3 p. 100, calculated by measurement in the sections of distances between electrode paths, was taken into account when tracing the grids with lines 0.5 mm apart on the left-hand side of the drawings. Posterior of the pituitary, the brain lies flat against the floor of the cranium ; in addition to using the horizontally cut brains to get the vertical positioning of the grids relative to each other and the horizontal zero, measurements were made in several fish to confirm the depth from horizontal zero to the bottom of the brain where the electrode hit bone.

The atlas is given in Plates 1-38. The distance posterior from the anterior-posterior zero is given in mm at the top of each drawing. The distance between the atlas drawings is either 0.1, 0.15, 0.2, 0.25 and 0.4 mm so that major conformation changes are illustrated, without undue repetition of regions that are not changing greatly. The numbers on the grid on each drawing show the depth from the midline in mm. The nomenclature for diencephalic nuclei, given in table 1, is the same as used for the goldfish (Peter and Gill, 1975).

TABLE 1

Nomenclature and list of abbreviations.

AC, anterior commissure	NPGI, <i>nucleus preglomerulosus pars lateralis</i>
AP, area pretectalis	NPGm, <i>nucleus preglomerulosus pars medialis</i>
CM, <i>Corpus mamillare</i>	NPO, <i>nucleus preopticus</i>
NAH, <i>nucleus anterioris hypothalami</i>	NPP, <i>nucleus preopticus periventricularis</i>
NAPv, <i>nucleus anterioris periventricularis</i>	NPPv, <i>nucleus posterioris periventricularis</i>
NAT, <i>nucleus anterior tuberis</i>	NPT, <i>nucleus posterior tuberis</i>
NC, <i>nucleus corticalis</i>	NR, <i>nucleus rotundus</i>
NCH, <i>nucleus cerebellosus hypothalami</i>	NRL, <i>nucleus recessus lateralis</i>
NDL, <i>nucleus dorsolateralis thalami</i>	NRP, <i>nucleus recessus posterioris</i>
NDLI, <i>nucleus diffusus lobi inferioris</i>	NSV, <i>nucleus saccus vasculosus</i>
NDM, <i>nucleus dorsomedialis thalami</i>	NTP, <i>nucleus posterioris thalami</i>
NDTL, <i>nucleus diffusus tori lateralis</i>	NVL, <i>nucleus ventralis lateralis</i>
NE, <i>nucleus entopeduncularis</i>	NVM, <i>nucleus ventromedialis thalami</i>
NG, <i>nucleus glomerulosus</i>	OC, optic chiasma
NH, <i>nucleus habenularis</i>	Pit, pituitary
NLG, <i>nucleus lateral geniculatus</i>	PC, posterior commissure
NLT, <i>nucleus lateral tuberis</i>	SCO, subcommissural organ
NP, <i>nucleus pretectalis</i>	SV, <i>saccus vasculosus</i>
	Tel, telencephalon

Discussion.

Although the procedure uses points of attachment to hold the head that are similar to other fish stereotaxic techniques, this procedure differs in that skull references were used for the zero point instead of a point on the dorsal surface of the exposed brain. The advantage of the present technique is that there is probably less chance of trauma to the brain. However, the skull coordinates are less precise ; there was about 70 p. 100 of success of placements of a hormone pellet in the NLT in the pituitary stalk region of rainbow trout (Crim *et al.*, 1981 ; Billard and Peter, unpublished results) compared to 84 and 80 p. 100 for comparable placements in *Fundulus* and goldfish, respectively (Peter and Gill,

1975 ; Peter *et al.*, 1975). The difficulty in the present technique is to place accurately in the mid-line of the brain ; the trout encephale can be slightly asymmetrical (Ridet *et al.*, 1974), which creates this problem. Finding the mid-line accurately can be improved by drilling a hole about 1 cm diameter with a circular saw to enable visualization, but this exposure of the brain causes additional trauma and is also more difficult.

Because this technique is based on use of a population of rainbow trout available to us, and another population may have a somewhat different skull size and shape due to strain or rearing conditions, using a new population of fish may require some adjustment in the coordinates of the atlas, particularly the distances posterior of zero. This can be done by determining if some structure, such as the pituitary or posterior commissure, can be reached precisely by the atlas coordinates. Another means of testing the accuracy of placement is to fix the entire head of a fish, cut it longitudinally in half, and then place half of the head in the apparatus to directly visualize the accuracy of placements. Also, for fish of a body size outside the range of application of this technique, the latter procedure can be used to make same adjustment of coordinates. However, rainbow trout of a very different size (less than 100 g, greater than 160 g) require another atlas because the size of the brain is not in proportion to size of the head (Bauchot *et al.*, 1973).

The nomenclature used for the diencephalic nuclei is the same as for goldfish (Peter and Gill, 1975). Some additional subdivisions of nuclei in the trout brain have been made by Ridet *et al.* (1974) and Ekengren and Terlou (1978), particularly in the NLT and NPO. Dubois *et al.* (1978, 1979) found that perikarya containing immunoreactive somatostatin were present in the NLT and NPP, but not in the NPO ; this confirms the distinction between the NPP and NPO, as suggested by Peter and Gill (1975). The trout NPO, as in other teleosts, is subdivided into the pars parvocellularis, containing small perikarya, and the pars magnocellularis, containing large perikarya ; Gomori-positive material appears earlier in the large NPO cells during ontogenesis (Plytycz, 1974), suggesting some functional differences between these two subdivisions of the NPO. Undoubtedly functional subdivisions in many nuclei will become evident with further studies. We hope that this stereotaxic atlas and technique will contribute to such studies.

*Reçu en mars 1981.
Accepté en juillet 1981.*

Acknowledgements. — This work was supported by NATO grant 1305, NSERC Canada, C.N.R.S. France Exchange Scientist grants to R. Billard and R. E. Peter, NSERC Canada grant A6371 to R. E. Peter, and INSERM grants to R. Billard. The drawings were made by J. Gallé.

Résumé. Le présent article décrit un appareil de stéréotaxie et une technique pour le positionnement d'électrodes dans les noyaux du diencephale de la truite Arc-en-ciel pesant entre 120 et 140 g, et sexuellement immature. Les noyaux du diencephale sont identifiés sur un atlas établi à partir de coordonnées stéréotaxiques externes.

References

- BAUCHOT R., PLATEL R., RIDET J., THIREAU M., 1973. L'encéphale de *Salmo gairdneri* Richardson (truite arc-en-ciel) (Pisces, Teleostei, Salmonidae). Recherche d'une grandeur de référence pour des études quantitatives. *Acta. zool.*, **54**, 53-64.
- BILLARD R., PETER R. E., 1977. Gonadotropin release after implantation of antiestrogens in the pituitary and hypothalamus of goldfish, *Carassius auratus*. *Gen. comp. Endocr.*, **32**, 213-220.
- CRIM L. W., PETER R. E., BILLARD R., 1981. Onset of gonadotropic hormone accumulation in the immature trout pituitary gland in response to estrogen or aromatizable androgen steroid hormones. *Gen. comp. Endocr.*, **44**, 374-381.
- DEMSKI L. S., 1978. Neuroanatomical substrates of reproductive behavior in male sunfish (Genus *Lepomis*). *Ann. Biol. anim. Bioch. Biophys.*, **18**, 831-836.
- DUBOIS M. P., BILLARD R., BRETON B., 1978. Use of immunofluorescence for localization of somatostatin-like antigen in the rainbow trout (*Salmo gairdneri*). Comparative distribution of LH-RF and neurophysin. *Ann. Biol. anim. Bioch. Biophys.*, **18**, 843-850.
- DUBOIS M. P., BILLARD R., BRETON B., PETER R. E., 1979. Comparative distribution of somatostatin, LH-RH, neurophysin and α -endorphin in the rainbow trout: an immunocytochemical study. *Gen. comp. Endocr.*, **37**, 220-232.
- EKENGREN B., TERLOU M., 1978. Hypothalamic centers and innervation of the hypophysis in the Atlantic salmon (*Salmo salar*) and the rainbow trout (*Salmo gairdneri*). *Ann. Biol. anim. Bioch. Biophys.*, **18**, 837-842.
- EPPLE A., 1967. A staining sequence for A, B and D cells of pancreatic islets. *Stain Techn.*, **42**, 53-61.
- MACEY M. J., PICKFORD G. E., PETER R. E., 1974. Forebrain localization of the spawning reflex response to exogenous neurohypophysial hormones in the killifish, *Fundulus heteroclitus*. *J. exp. Zool.*, **190**, 269-280.
- PETER R. E., 1970. Hypothalamic control of thyroid gland activity and gonadal activity in the goldfish, *Carassius auratus*. *Gen. comp. Endocr.*, **14**, 334-356.
- PETER R. E., 1977. Effects of midbrain tegmentum and diencephalon lesions on swimming and body orientation in goldfish. *Exp. Neurol.*, **57**, 922-927.
- PETER R. E., GILL V. E., 1975. A stereotaxic atlas and technique for forebrain nuclei of the goldfish, *Carassius auratus*. *J. comp. Neurol.*, **159**, 69-102.
- PETER R. E., MACEY M. J., GILL V. E., 1975. A stereotaxic atlas and technique for forebrain nuclei of the killifish, *Fundulus heteroclitus*. *J. comp. Neurol.*, **159**, 103-128.
- PETER R. E., PAULENCU C. R., 1980. Involvement of the preoptic region in gonadotropin release-inhibition in goldfish, *Carassius auratus*. *Neuroendocrinology*, **31**, 133-141.
- PLYTYCZ B., 1974. Ontogenesis of the hypothalamic neurosecretory system in the trout (*Salmo trutta trutta* L.). *Bull. Acad. Pol. Sci.*, **22**, 709-712.
- RIDET J. M., DIAGNE M., BAUCHOT R., PLATEL R., 1974. Etude quantitative de la variabilité intraspécifique des principales subdivisions encéphaliques de la truite arc-en-ciel *Salmo gairdneri* Richardson (Pisces, teleostei, salmonidae). *Bull. Museum nat. Hist. nat.*, **224**, 674-703.

PLATES 1-38

Atlas of the diencephalon. The number at the top of each drawing gives the distance in mm posterior of the zero point (see fig. 3). The lines of the grid were drawn to scale 0.5 mm apart. The numbers on the vertical (left) side of each grid give the distances down from the horizontal zero point. The numbers on the bottom side each grid give the distances from the midline.

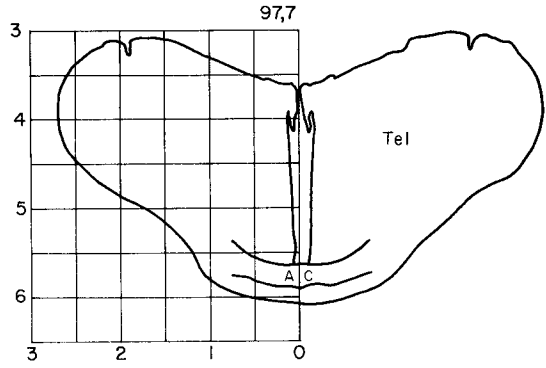

PLATE 1

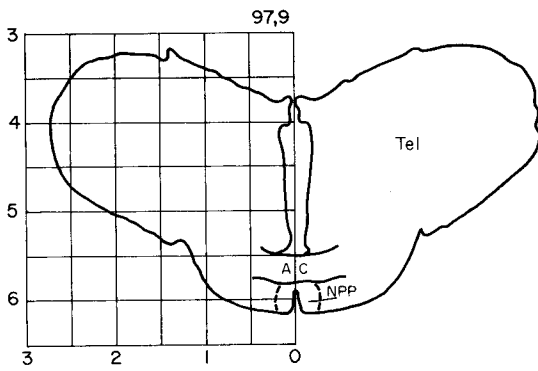

PLATE 2

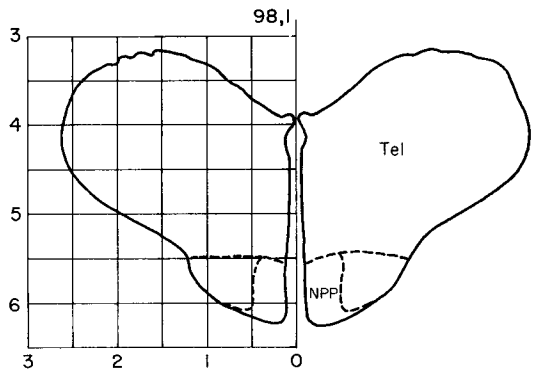
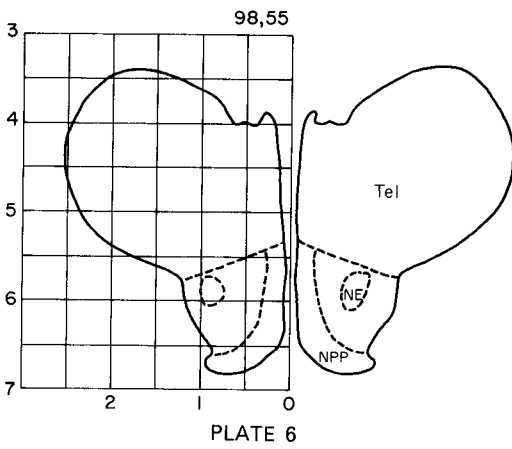
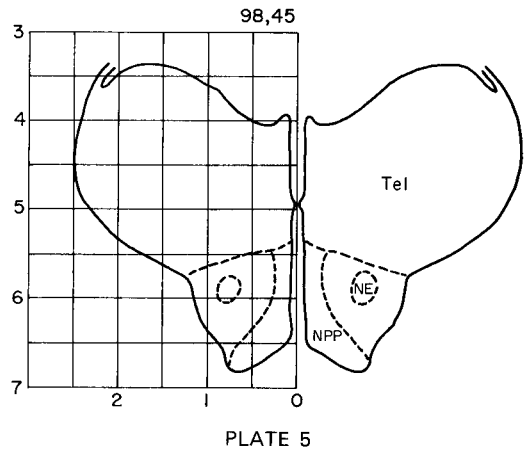
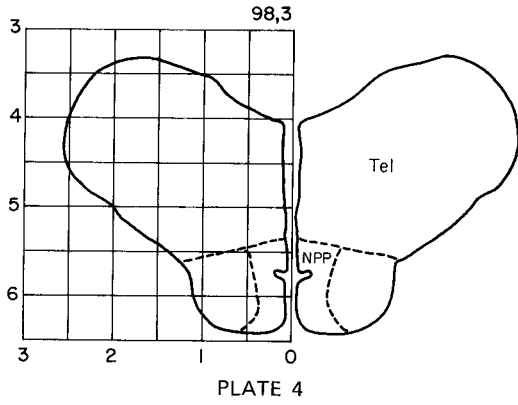
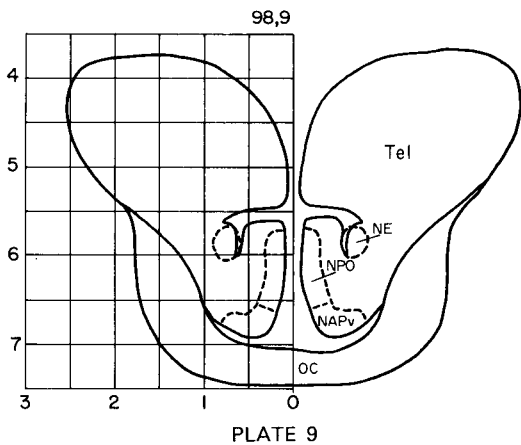
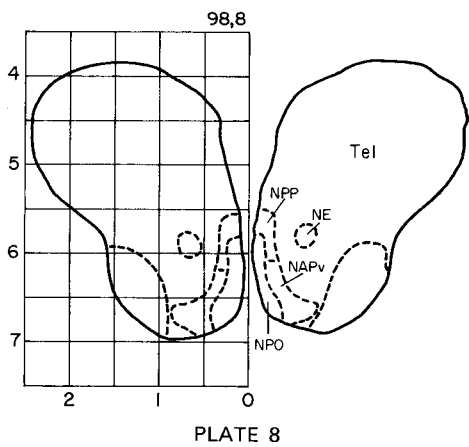
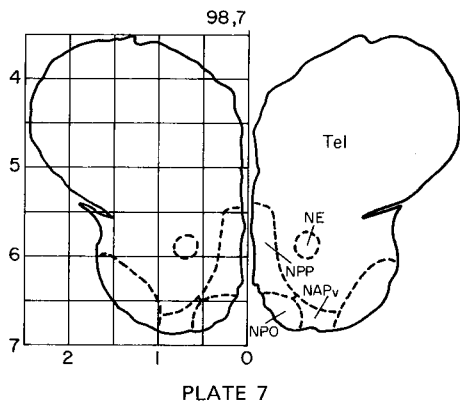

PLATE 3





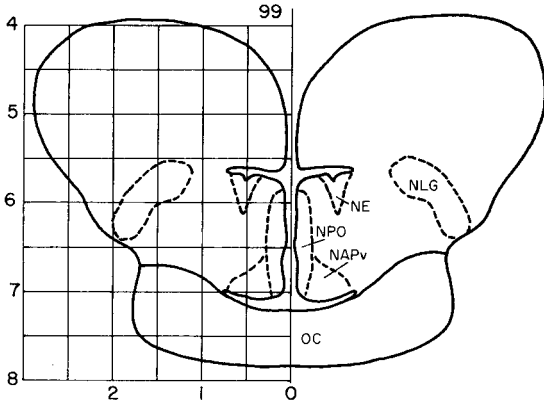

PLATE 10

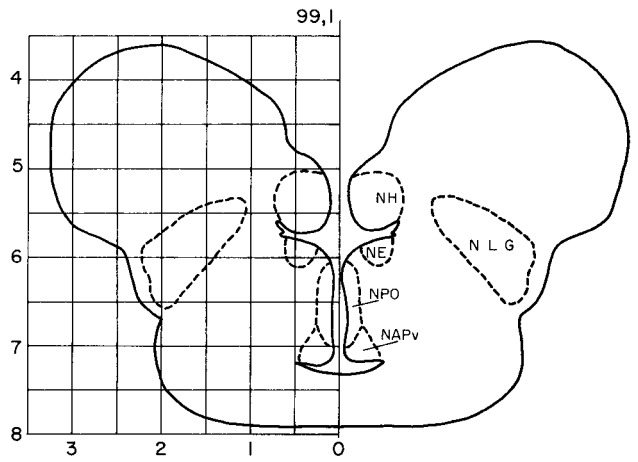

PLATE 11

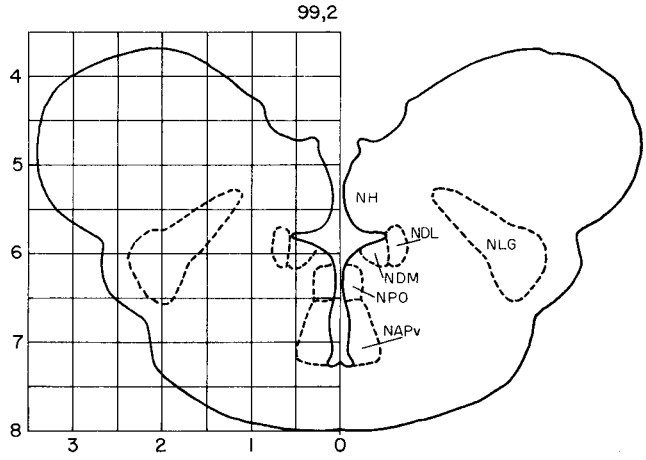

PLATE 12

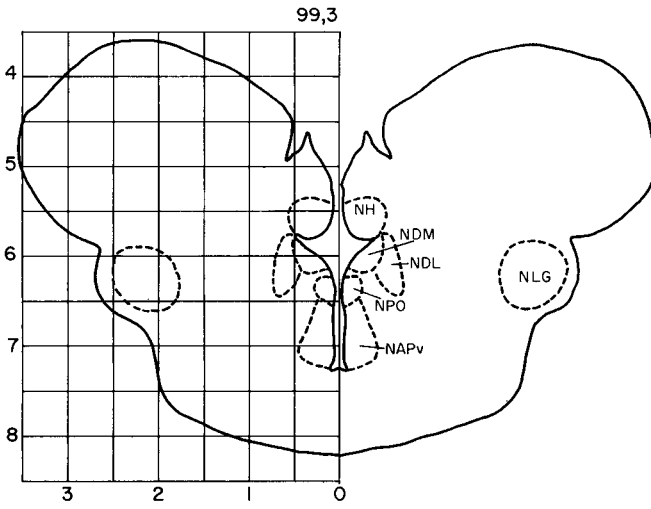

PLATE 13

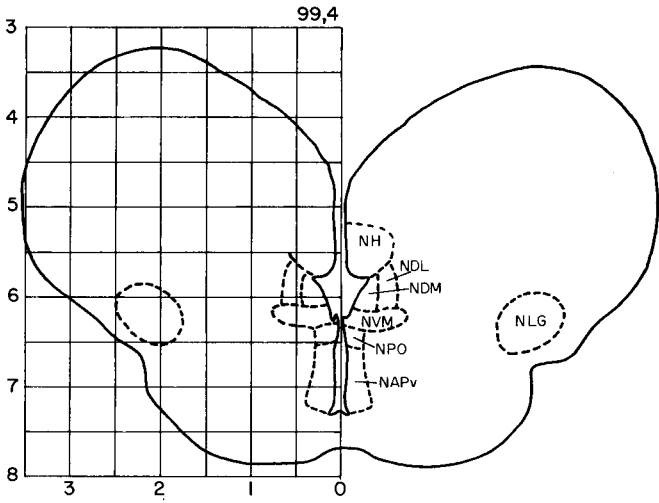

PLATE 14

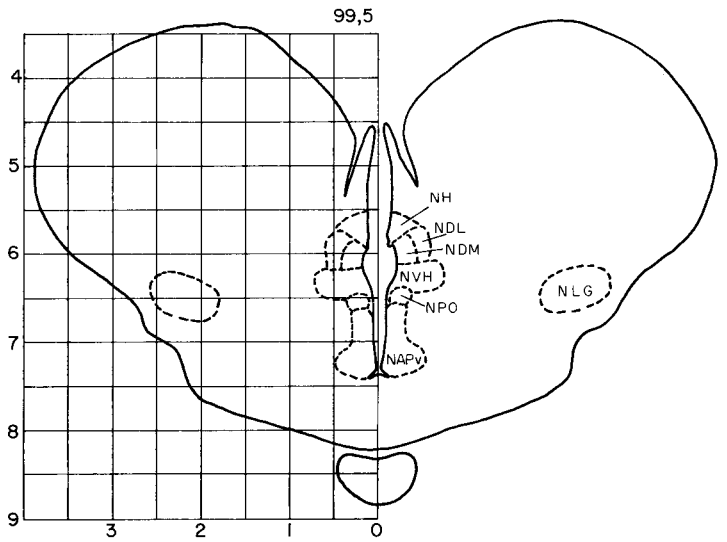

PLATE 15

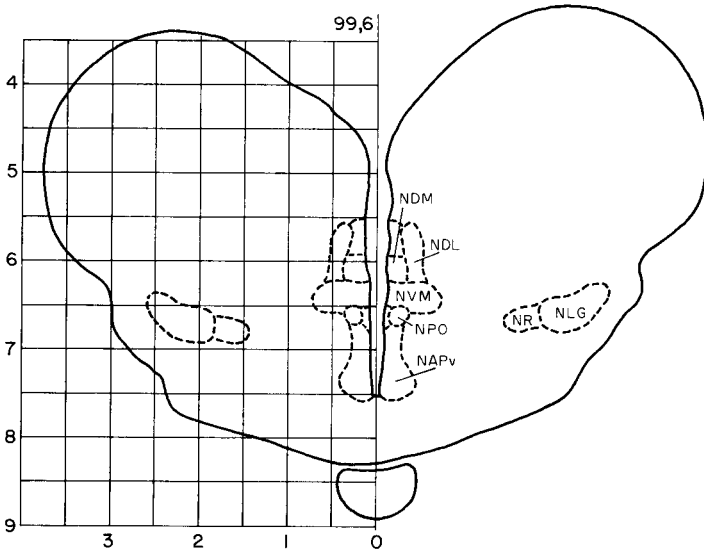

PLATE 16

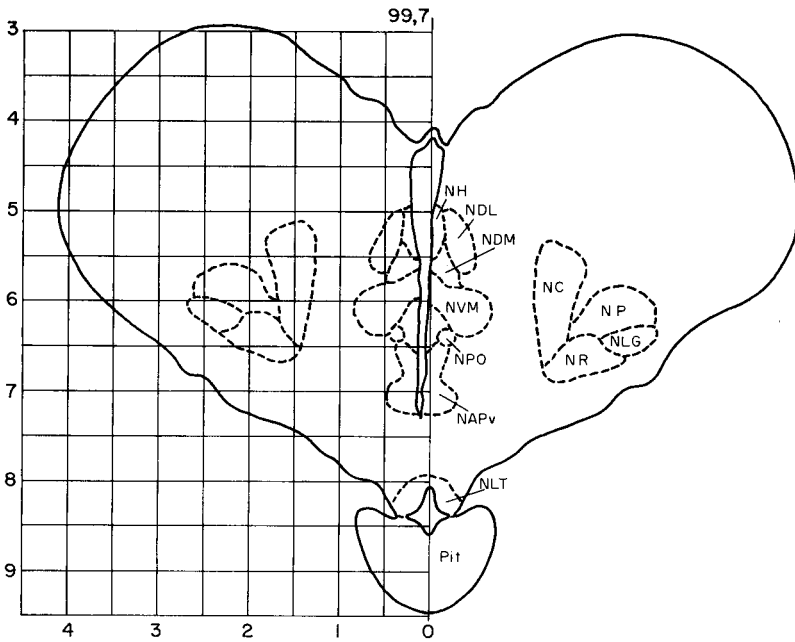
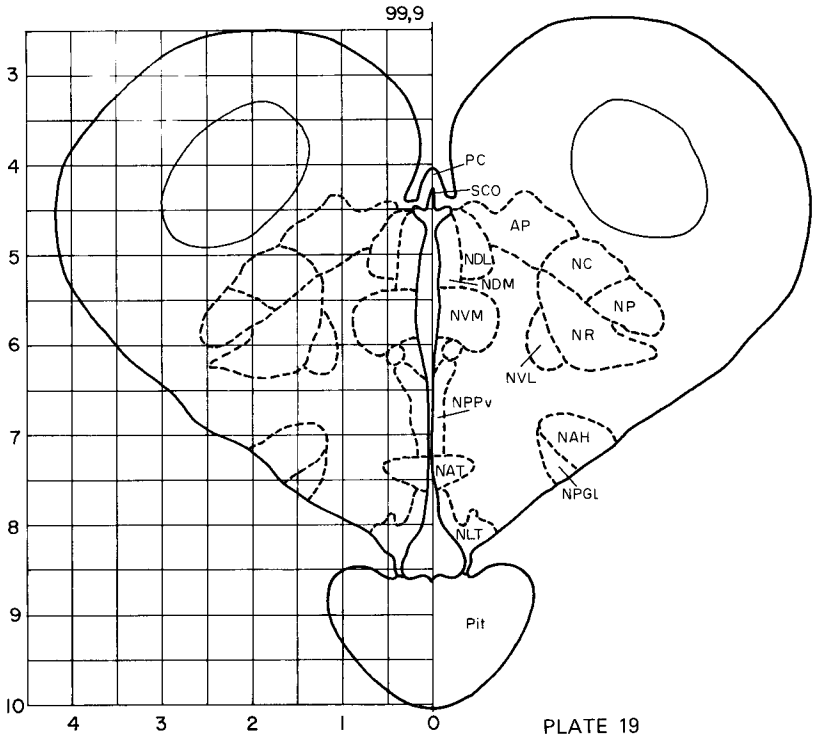
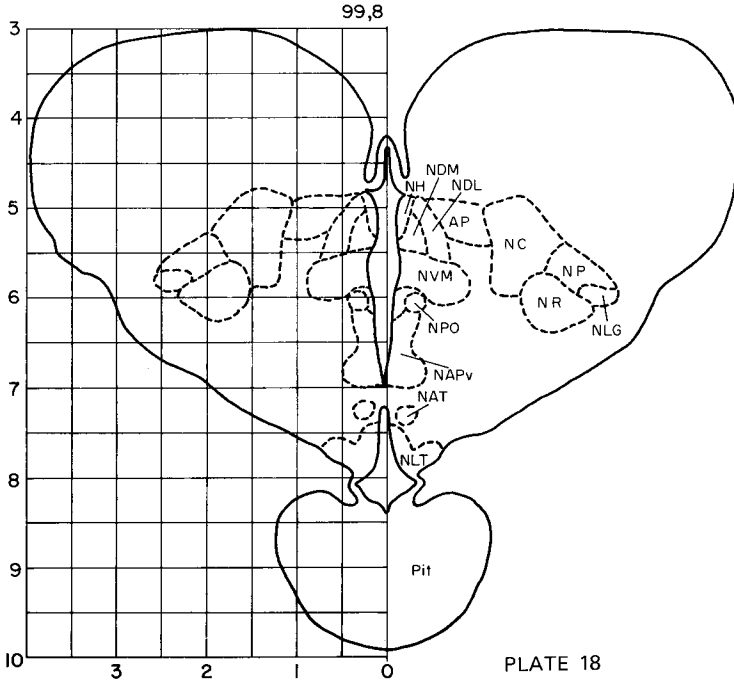

PLATE 17



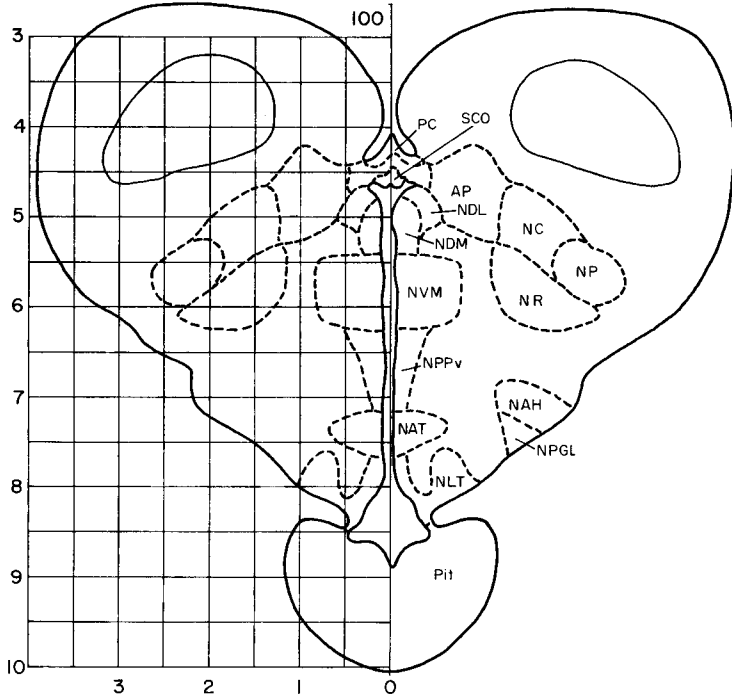

PLATE 20

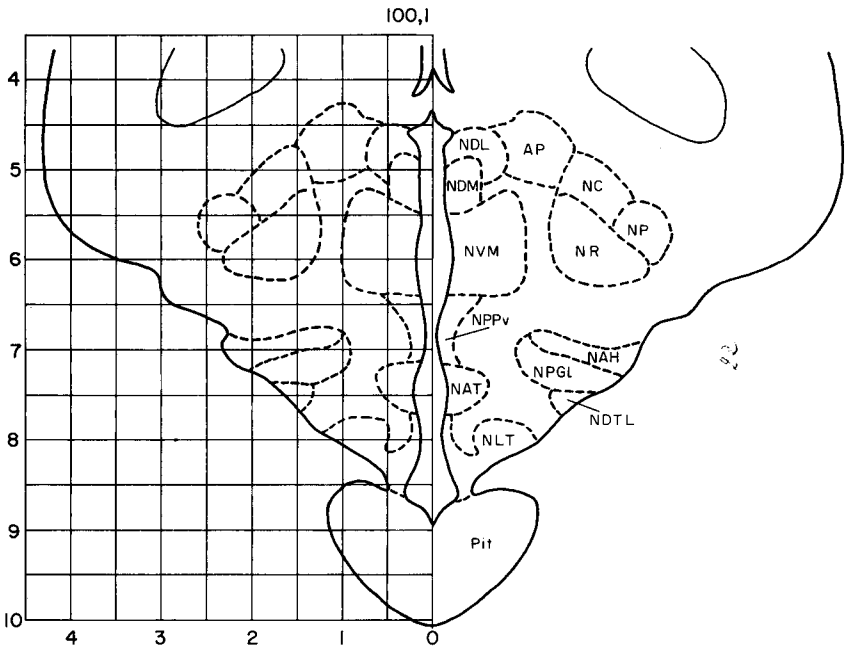

PLATE 21

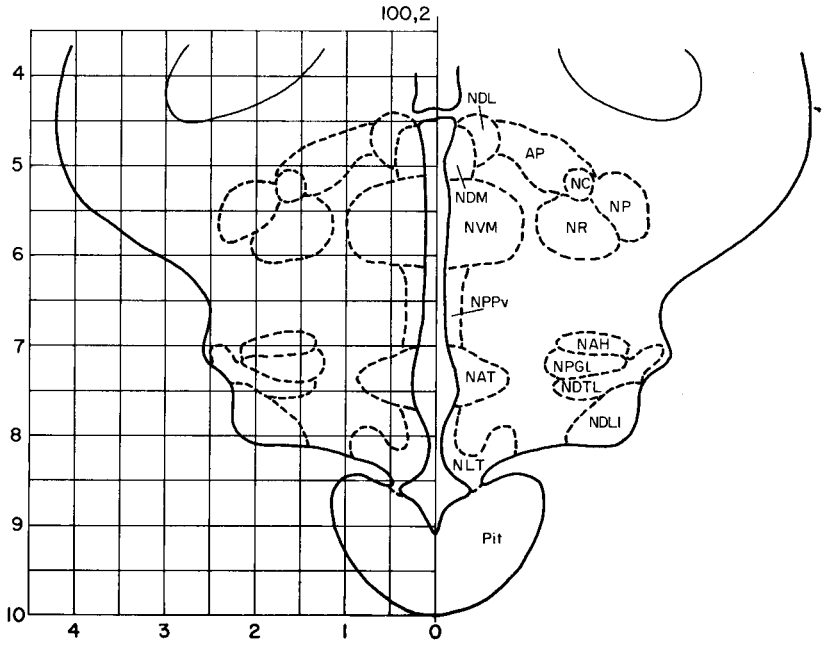

PLATE 22

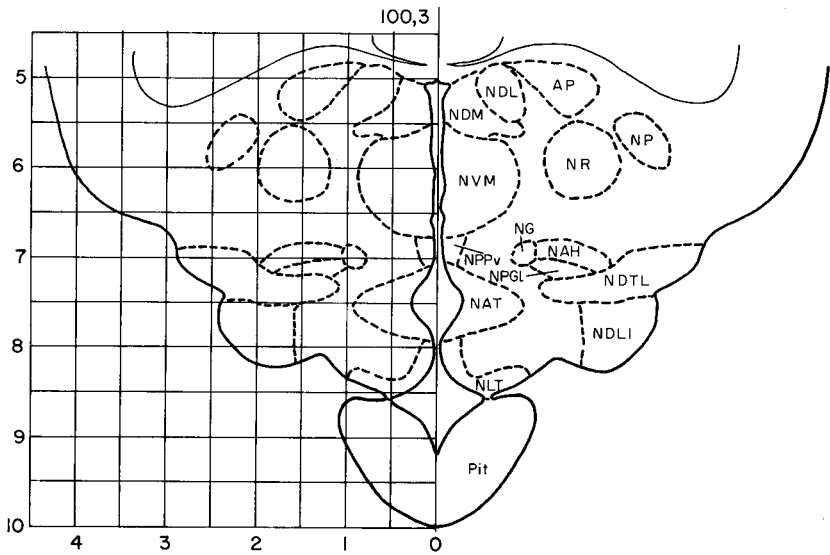

PLATE 23

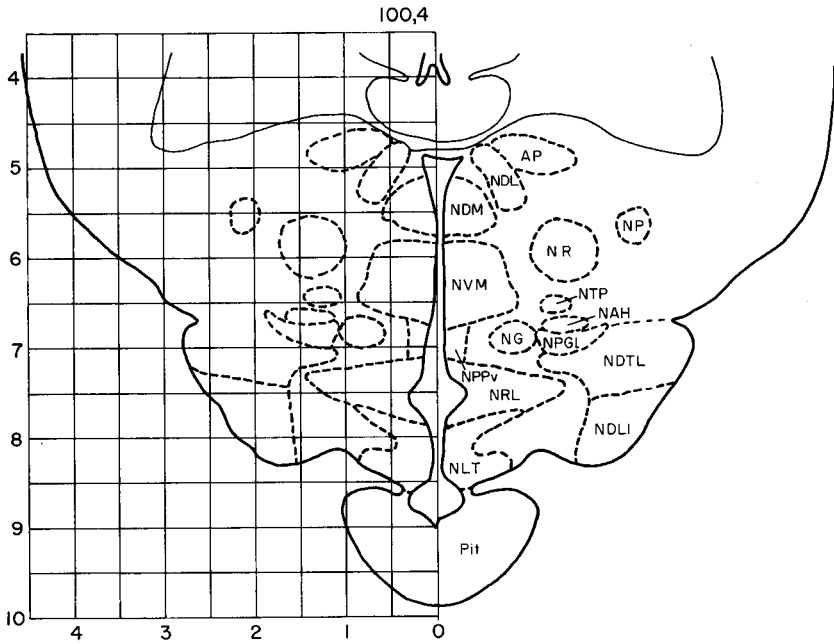

PLATE 24

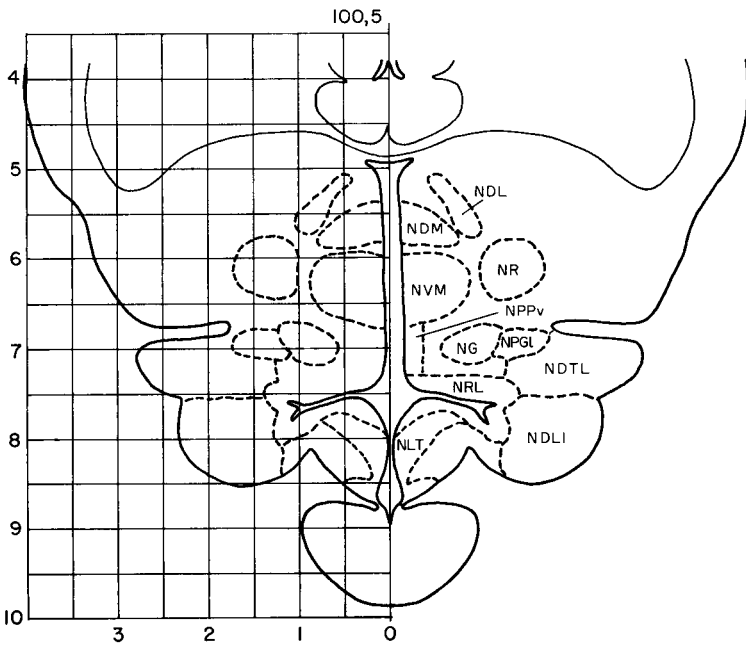

PLATE 25

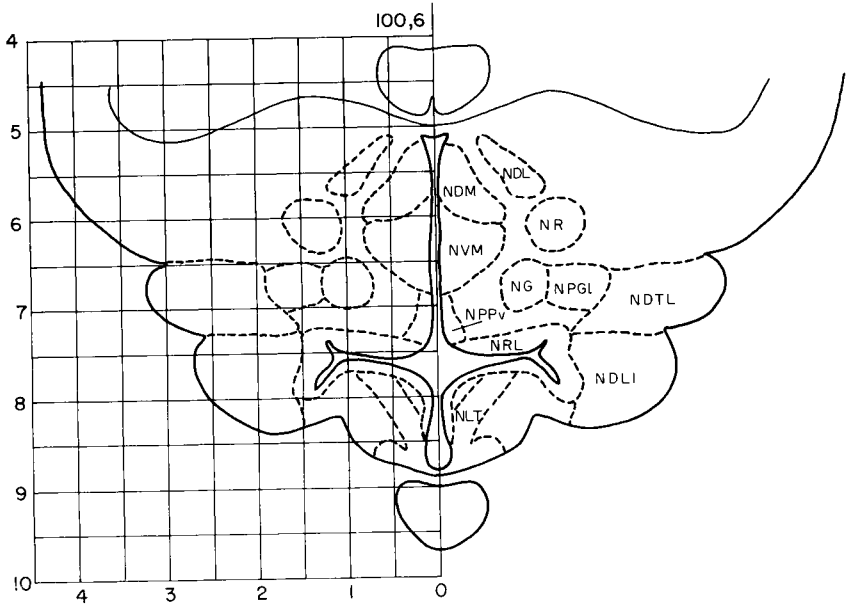

PLATE 26

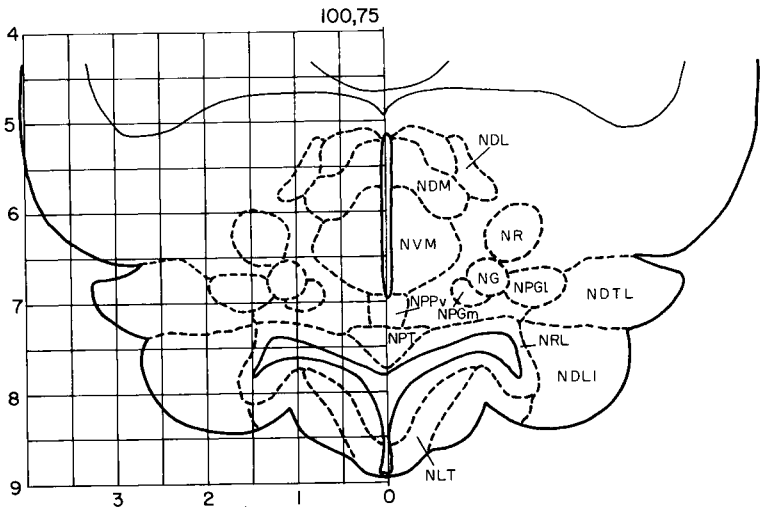

PLATE 27

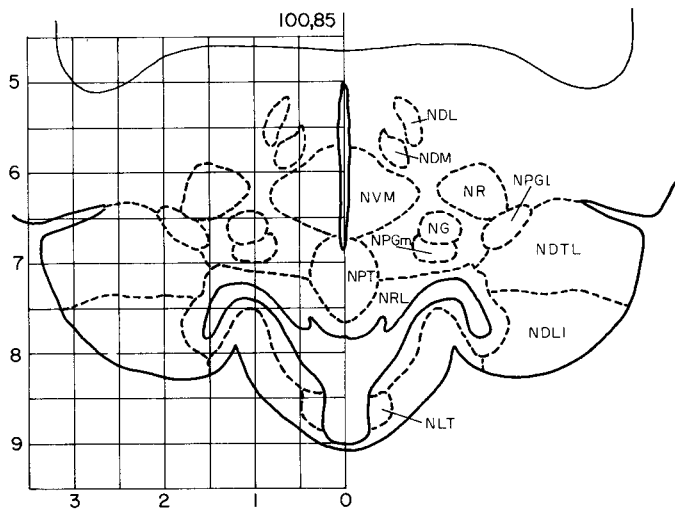

PLATE 28

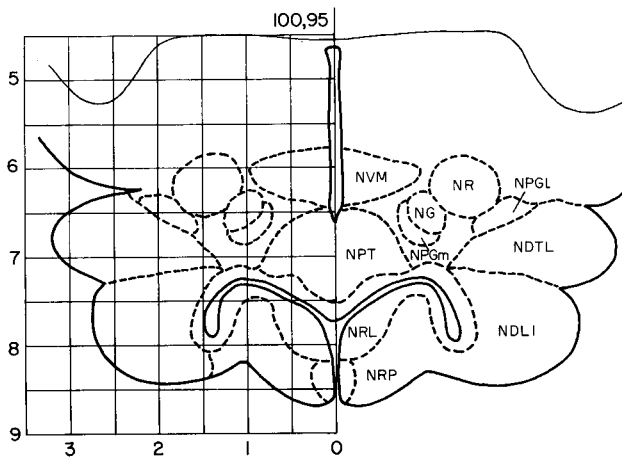

PLATE 29

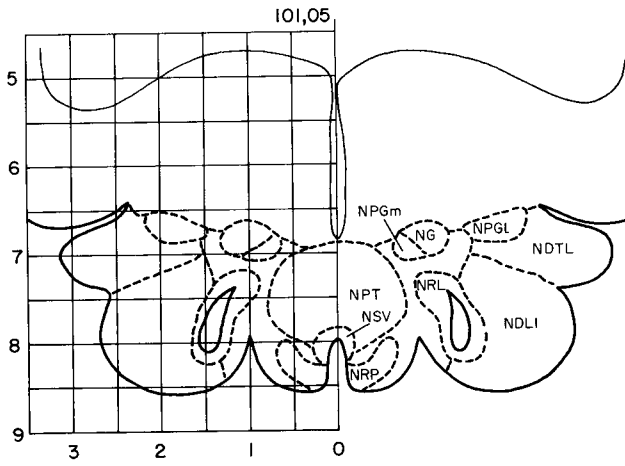

PLATE 30

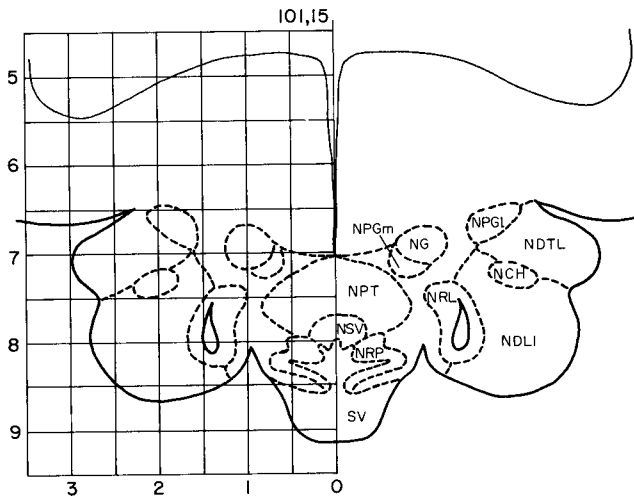

PLATE 31

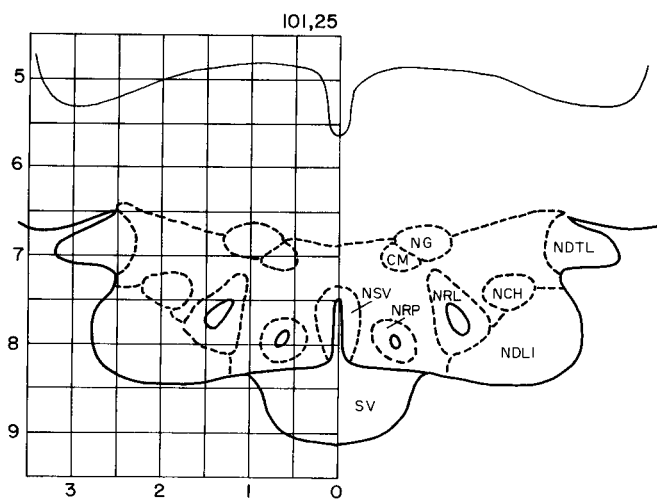

PLATE 32

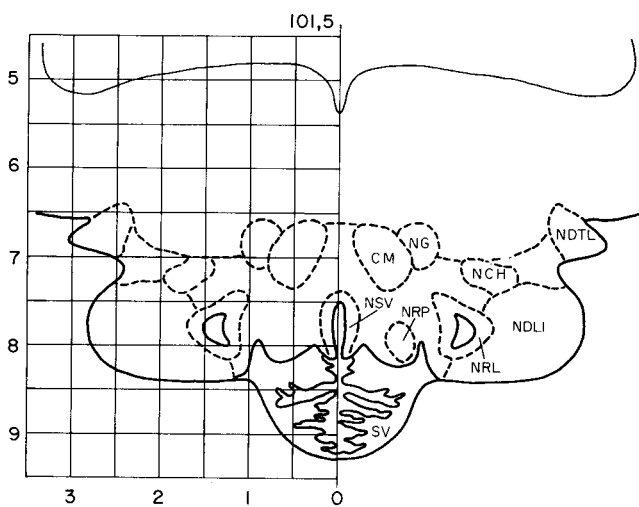

PLATE 33

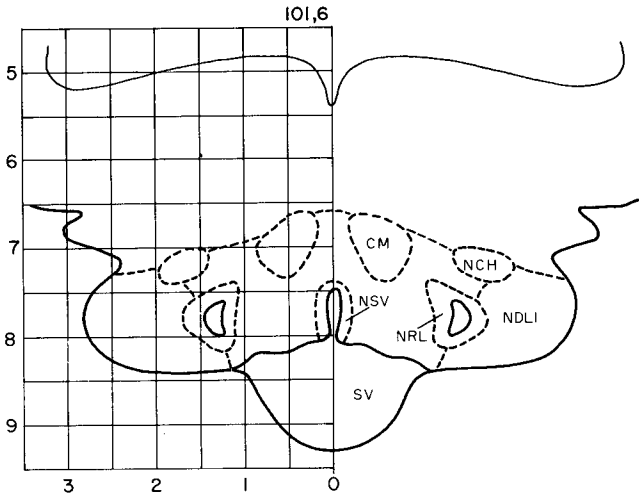

PLATE 34

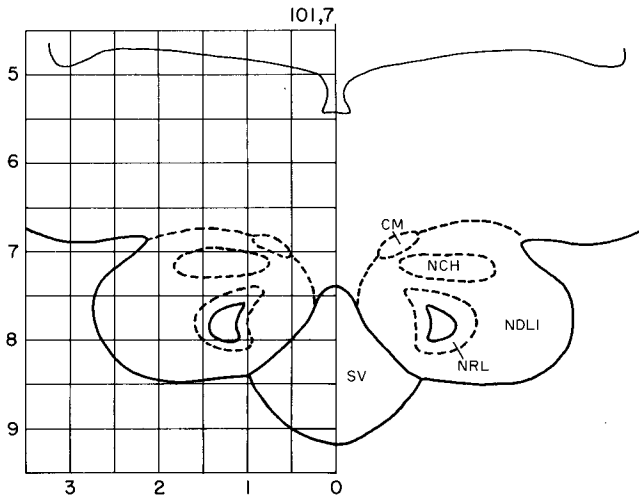

PLATE 35

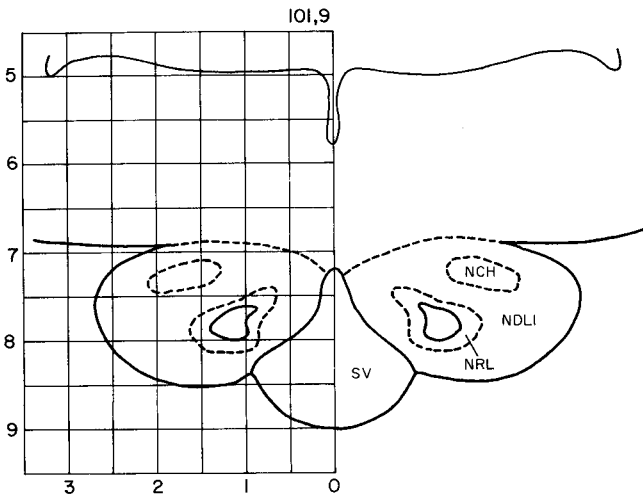

PLATE 36

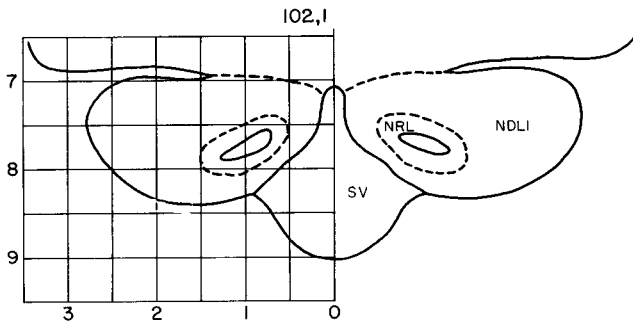

PLATE 37

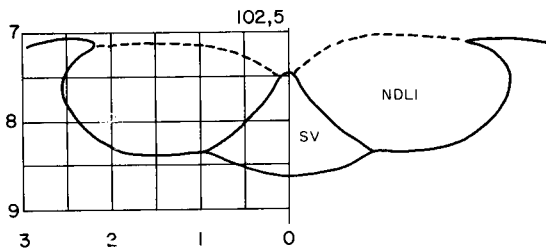

PLATE 38