



**HAL**  
open science

## Splash drift on light sandy soils: a field experiment

Dirk Goossens, Jean Poesen, Jens Gross, Wim Spaan

► **To cite this version:**

Dirk Goossens, Jean Poesen, Jens Gross, Wim Spaan. Splash drift on light sandy soils: a field experiment. *Agronomie*, 2000, 20 (3), pp.271-282. <10.1051/agro:2000126>. <hal-00886035>

**HAL Id: hal-00886035**

**<https://hal.science/hal-00886035v1>**

Submitted on 11 May 2020

**HAL** is a multi-disciplinary open access archive for the deposit and dissemination of scientific research documents, whether they are published or not. The documents may come from teaching and research institutions in France or abroad, or from public or private research centers.

L'archive ouverte pluridisciplinaire **HAL**, est destinée au dépôt et à la diffusion de documents scientifiques de niveau recherche, publiés ou non, émanant des établissements d'enseignement et de recherche français ou étrangers, des laboratoires publics ou privés.



HAL Authorization

## Splash drift on light sandy soils: a field experiment

Dirk GOOSSENS<sup>a,b\*</sup>, Jean POESEN<sup>b,d</sup>, Jens GROSS<sup>c</sup>, Wim SPAAN<sup>a</sup>

<sup>a</sup> Erosion and Soil and Water Conservation Group, Wageningen Agricultural University, Nieuwe Kanaal 11,  
NL-6709 PA Wageningen, The Netherlands

<sup>b</sup> Laboratory for Experimental Geomorphology, Katholieke Universiteit Leuven, Redingenstraat 16 bis, B-3000 Leuven, Belgium

<sup>c</sup> Institute of Soil Technology, Friedrich-Missler-Strasse 46-50, D-28211 Bremen, Germany

<sup>d</sup> Fund for Scientific Research, Flanders, Belgium

(Received 9 June 1999; revised 10 January 2000; accepted 3 February 2000)

**Abstract** – Vertical splash drift profiles and horizontal splash drift amounts were measured during a very wet week on a 7.5 ha agricultural field in Grönheim, Germany. Splash was measured on 45 plots distributed all over the field, at seven (or eight) heights above the surface. The data show that the vertical splash drift profile is best described by a power function of the form  $G = a \cdot z^b$  (or, alternatively,  $G = c \cdot z^b - 1$ ), where  $G$  is the total mass of sediment splashed up to a height  $z$  and  $a$ ,  $b$  and  $c$  are empirical parameters. The decrease of  $G$  with height  $z$  is highly variable within the field, even for one and the same rain shower. Also, the total horizontal splash drift amounts show significant differences within the field. There is no clear relationship between these splash characteristics on the one hand and the topographic position or the properties of the topsoil on the other. It is suggested that spatial variations in rainfall during the rain events are the major cause of the differences in splash drift over the field. Total horizontal splash flux is fairly well predicted by a theoretical splash transport model developed earlier by the second author. Due to the effect of the wind (causing oblique rainfall and an extra-displacement of the soil particles in the downwind direction) the observed fluxes are somewhat higher than the predicted ones, but both are of the same order. The difference indicates the significance of the inclination of the rain with respect to the process of hydraulic splash.

**splash / splash drift / wind**

**Résumé** – **Déplacement par éclaboussures sur sols sablonneux légers : étude au champ.** Des profils verticaux et des flux horizontaux de déplacements par éclaboussures ont été mesurés pendant une semaine pluvieuse sur 7,5 ha de champs agricoles à Grönheim, Allemagne. Les mesures ont été faites sur 45 sites répartis sur tout le champ, à sept ou huit hauteurs au-dessus du sol. Les données montrent que le profil vertical du déplacement par éclaboussures est bien décrit par une fonction de la forme  $G = a \cdot z^b$  (ou  $G = c \cdot z^b - 1$ ), dans laquelle  $G$  est la masse totale de sédiments éclaboussés à une hauteur  $z$  et  $a$ ,  $b$  et  $c$  sont des paramètres empiriques. La diminution de  $G$  avec la hauteur  $z$  varie considérablement dans le champ, y compris pour une même averse. Aussi, le flux total du déplacement horizontal par éclaboussures

---

Communicated by Jim Douglas (Penicuik, UK)

---

\* Correspondence and reprints  
dirk.goossens@geo.kuleuven.ac.be

présente-t-il des différences significatives au sein du champ. Ces variations spatiales ne s'expliquent pas par des différences dans la position topographique ni par les propriétés de la couche arable du sol, mais résultent très probablement des variations spatiales dans les précipitations (spécialement l'intensité de pluie) au cours des averses. Le flux total horizontal est assez bien prédit par un modèle théorique de transport par éclaboussures, développé précédemment par le second auteur. À cause des effets du vent, qui provoque une pluie en oblique et un déplacement supplémentaire des particules du sol dans le sens du vent, les flux observés sont un peu plus élevés que ceux prédits, mais restent du même ordre. La différence entre les deux flux donne une indication de l'importance de l'inclinaison de la pluie en relation avec le processus d'éclaboussure par l'eau.

## déplacement par éclaboussure / vent / transport de sédiment

### 1. Introduction

In various studies, splash erosion of topsoils has received considerable attention [10, 18, 21, 25]. With respect to sediment transport by raindrop splash, data on detached masses as well as on lateral particle transport (under vertical rain, i.e., without wind) are available [20, 28]. However, little is known about the vertical displacement distances of sediment by raindrop splash and about the transport of the grains by wind-driven rain. De Ploey [5] and Jungerius et al. [12], studying wind erosion on sand dunes during rainy periods in Belgium and The Netherlands, already pointed to the importance of raindrop impact as a major mechanism bringing sediment into the airflow. Rutin [23] termed the combined effect of raindrop detachment and sediment transport by wind 'splash drift'. In this study, the term 'splash drift' is used to indicate wind transport of sediment particles that have been detached by wind-driven rain.

Quantitative data about splash drift are scarce. Moeyersons [14] measured splash-saltation fluxes under oblique rain. Gabriëls et al. [8] measured horizontal splash drift distances in a wind tunnel equipped with a rainfall simulator. In the field, de Lima et al. [4] and van Dijk et al. [31] used saltiphones to measure sediment transport under different rain intensities. Their data, however, did not provide information regarding the vertical distribution of the transported sediment nor about the total sediment flux in the downwind direction. No information is available of the effect of local field parameters such as topography, or the sedimentological

characteristics of the topsoil, on the splash drift and the splash drift profile.

Despite the small number of splash drift studies, aeolian splash drift is a process that occurs during nearly every rain storm. It causes a significant net displacement of matter and is thus important with respect to the long-term soil erosion in a field, especially in areas where wind direction is fairly constant. On the other hand, and probably even more important, splash drift is a major mechanism for moving soil-borne contaminants (pathogens, dioxins, radionuclides, etc.) to plants, or for the exchange of these or other contaminants between the plants [7, 27]. It thus plays a very important role in the spreading of plant diseases within a field, or even between adjacent fields. Aeolian splash drift thus deserves considerable attention, both from a sedimentological and a phytopathological point of view.

Although the initiation of aeolian sand erosion is caused by aerodynamic lift due to vertical pressure differences near the soil surface, the erosion process becomes rapidly dominated by the bombardment of the top layer by impacting sand grains [2]. The impact process, which has been termed (aeolian) splash [29], shows similarities with the hydraulic splash caused by impacting raindrops although the energy balance differs greatly between these processes. In general, dry aeolian splash is a much more elastic process than hydraulic splash. The transfer of energy from the impacting material (grains or drops) to the soil surface is of the order of 40% for aeolian splash [34] but is 80–95% for impacting raindrops [9, 15, 30]. The kinetic energy of impacting raindrops is much

larger than that of impacting sand grains, however, and the relative importance (with respect to sediment transport) of both processes in areas susceptible to wind erosion is currently unknown. Also unknown is the vertical evolution of the splash drift, i.e., the vertical splash drift profile. Are vertical splash drift profiles similar to vertical aeolian sediment transport profiles or are they fundamentally different due to the differences in the energy balance? As quoted above, this information is quite important with respect to the movement of soil-borne contaminants to plants and other objects present on or near the earth's surface.

This paper investigates splash drift measured on an agricultural field in NW Germany during a rainy week in June 1998. Vertical splash drift profiles and horizontal splash drift amounts are calculated, and relationships between the static properties of the soil surface (topography, grain size, cohesive fraction, organic matter) and the amount of horizontal splash drift are investigated.

## 2. The study area

The splash drift experiment was carried out on an agricultural field in Grönheim, Lower Saxony,

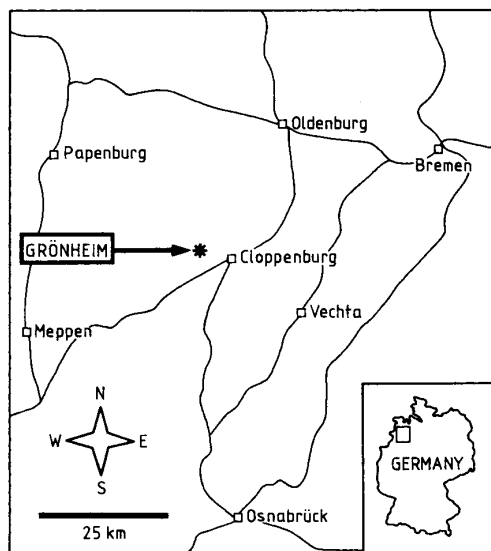

Figure 1. Situation of the Grönheim site.

Germany (Fig. 1). The field is located about 14 km west of the town of Cloppenburg and has a size of approximately 320 × 230 m (area: 7.55 ha). The landscape in this part of Germany is predominantly flat, with a slightly undulating microtopography (slopes usually < 2%).

Figure 2A is a topographical map of the test field. The northern and southern part of the field are rather flat, with differences in height of the order of a few decimetres. A small valley (depth of incision: approximately 1.5 m) occurs in the W corner of the field, and another depression (of the same depth) in the E corner. In general, the test field is situated at an absolute height of approximately 34 m.

Characteristics of the topsoil in the test field (upper 5 cm) are given in the Figures 2B–D and also in Figure 3. The topsoil is predominantly sandy, with a considerable amount of silt and clay at several locations. In the USDA textural classification it belongs to the classes ‘sand loam’ and ‘loam sand’. The sand itself is very fine (median diameter around 125 µm) and well sorted. It is mainly of glacial origin. In the SW part of the field, and particularly in the SW corner, very small rock fragments 2–5 mm in size occur in the sand. Their cover percentage is smaller than 1%. Large boulders of erratic granite are found all over the field, but most of them have been removed from the land by the farmers.

The proportion of silt and clay is considerable in the NW part of the test area (Fig. 2C). In the SE part, the sand is better sorted and the silt + clay fraction is less than 20%. The sand is predominantly composed of quartz, with some enrichment of ferruginous minerals.

The organic matter content is relatively high, with large differences within the test field (Fig. 2D). Highest values are observed in the SW, whereas in the NE the topsoil contains less organic matter.

Annual average rainfall at Grönheim is 750 mm. There are no specially dry or wet periods in the year, although the wettest months are normally in summer (July, August). Short, heavy rain storms may occur at any time in the year, but May, June and July are very typical for these events. During

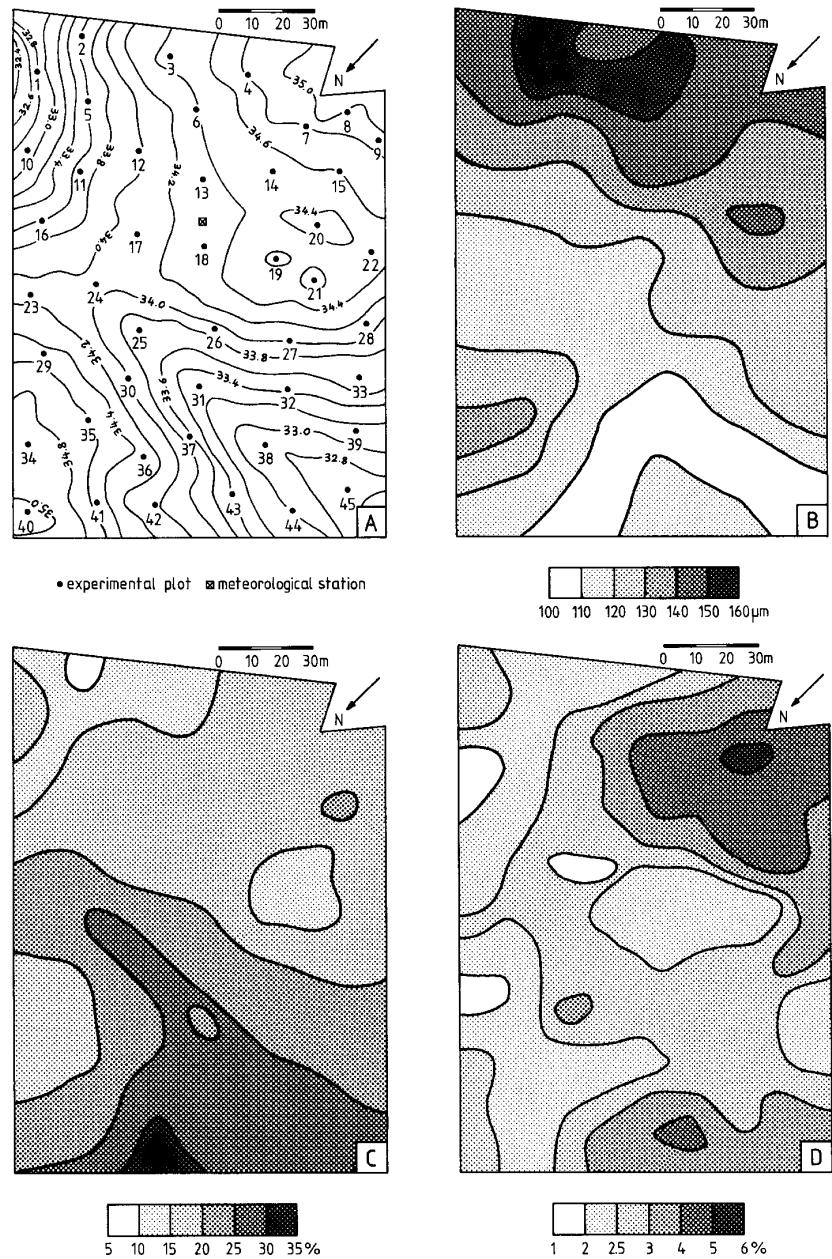

**Figure 2.** Characteristics of the test field: **A)** Topographical map with an indication of the 45 test plots; **B)** median particle diameter  $D_{50}$ ; **C)** mass percentage of the silt+clay fraction; **D)** mass percentage of organic matter.

such storms, the wind usually blows from the SW, W or NW.

### 3. Instrumentation and methodology

Forty-five locations, more or less uniformly distributed over the test field, were selected from the

topographical map. Their position is indicated in Figure 2A. In each plot, a vertical mast containing a set of 7 (or 8) sediment catchers was erected (Fig. 4). The catchers were originally installed to measure dry aeolian sand transport over the test field, but since in the test period only splash erosion occurred, they provided an excellent opportunity to study the horizontal splash drift.

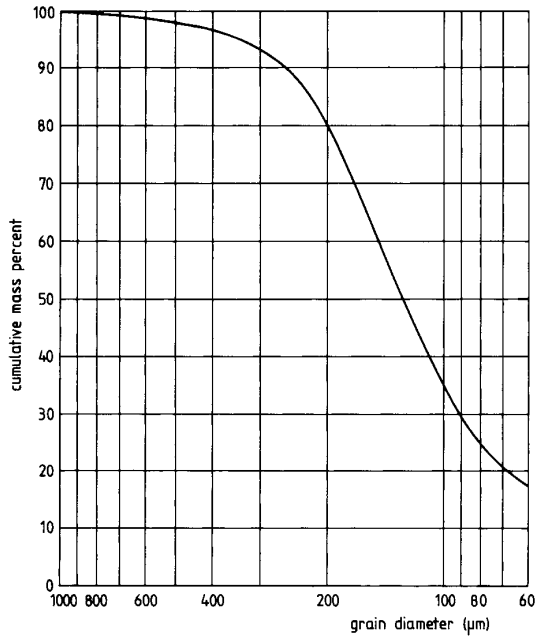

**Figure 3.** Typical grain-size distribution curve of the Grönheim topsoil.

Thirty-three masts had a length of 140 cm, whereas the 12 remaining masts were 240 cm long. All masts were positioned in a vertical plastic cylinder driven 40 cm deep in the ground. The catchers consisted of a 9.4 cm long, horizontal plastic bottle 4.8 cm in diameter, with a horizontal inlet and a horizontal outlet made of glass (inner diameter: 0.75 cm). A technical scheme is shown in Figure 5. The catcher is known as the Modified Wilson And Cooke Catcher (or MWAC), and was first described by Wilson and Cooke in 1980 [35]. Sediment transported by splash drift enters the inlet and settles in the tube or in the bottle; due to the pressure drop inside the bottle only clean air is evacuated via the outlet. By cleaning the exterior of the bottle and the tubes, the horizontal splash drift flux through the inlet tube can be determined provided the orifice of the tube is perpendicular to the wind. This is accomplished by adding a wind vane to the mast (Fig. 4) and allowing the mast to rotate freely in the plastic cylinder.

The MWACs were installed at the following heights above the soil surface (values refer to the centre of the inlet tubes): 5, 12, 19, 26, 45, 70, and

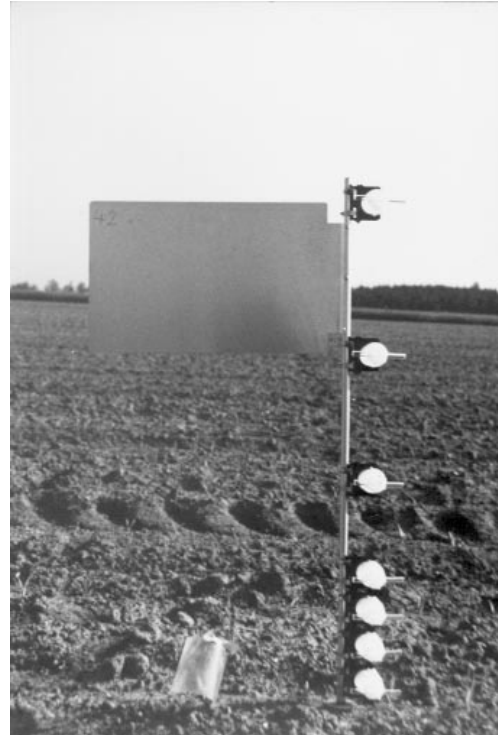

**Figure 4.** Mast with the MWAC catchers.

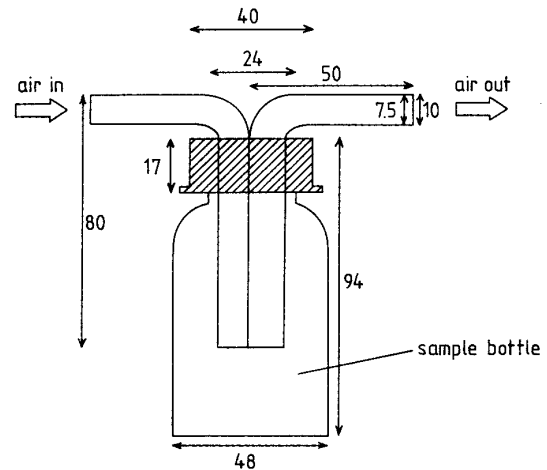

**Figure 5.** Technical scheme of the MWAC sediment catcher. All dimensions are in mm.

100 cm. An extra MWAC was attached to the 240-cm masts at a height of 200 cm. After the experiment it appeared that hardly any sediment had been collected by these 200-cm MWACs.

Results presented later in this paper therefore refer to the splash drift up to 100 cm above the soil surface, and no distinction was made between the 140-cm masts and the 240-cm masts in Figure 2A.

The sediment caught by each MWAC was weighed on a Mettler balance (accuracy: 0.001 g) after the catchers (and the sediment) had been dried at 110 °C. Horizontal splash drift near the inlet of each MWAC collector was then calculated by dividing the sediment amounts through the inlet size of the catchers.

Wind (speed and direction) and rainfall were measured from a small meteorological station located in the SE part of the test field (see Fig. 2A). Wind data were obtained as 10-min averages whereas rainfall was measured hourly. Wind speed was recorded at a height of 2 m, wind direction at 10 m. The inlet of the rain gauge was at 1 m above ground-level.

During the experiment, small (< 20 cm) maize plants sown in rows about 80 cm apart were present in the field. Near the splash plots the crops

had been locally removed two weeks earlier; the influence of the maize on the splash drift was, therefore, very small, and it is reasonable to assume that it did not have any substantial effect on the splash drift results presented in this paper.

#### 4. Meteorology

Measurements were made during a very wet week (total rainfall amount: 77.0 mm) in June 1998. The plots were installed on 3 June (around noon) and taken from the field on 11 June (also around noon). Figure 6 shows that seven rain events occurred during the experiment. For each event, the 10-min wind data (and the rain data) are shown in detail in the upper part of the figure. Most rain fell during three events on 5 and 6 June, with a maximum hourly average of 8.8, 6.7 and 17.9 mm, respectively. Highest intensity was reached during the last event, which lasted for approximately 10 min only. Maximum rainfall

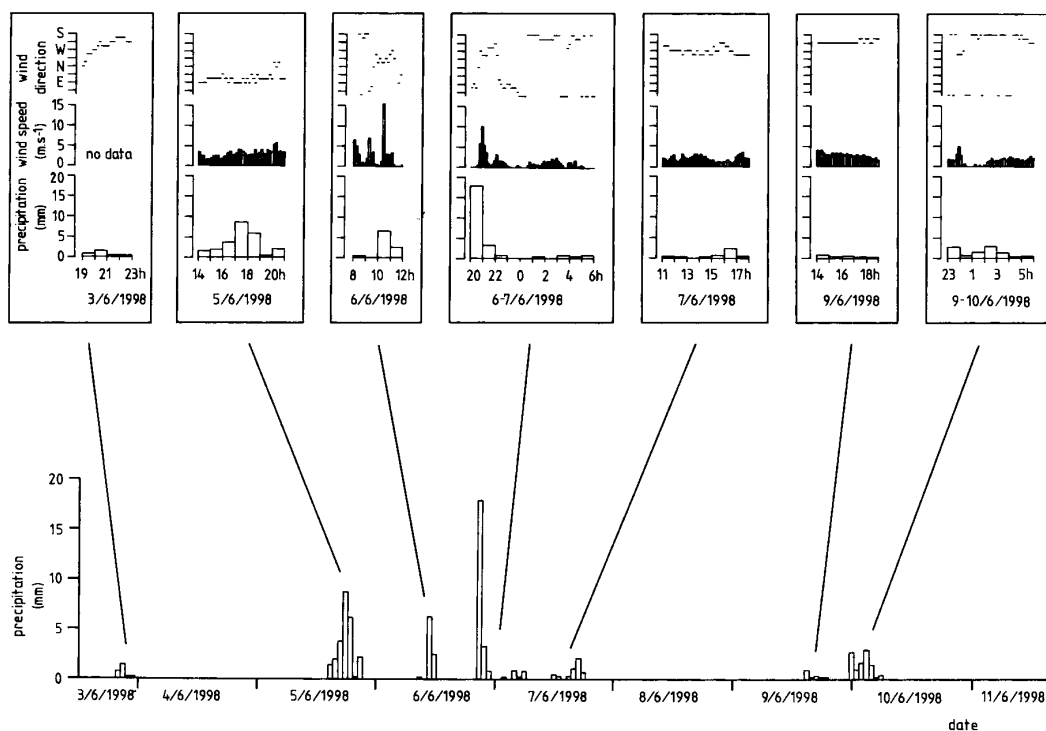

Figure 6. Wind and rain characteristics during the 8-day experiment.

intensity during the experiment was therefore of the order of about  $100 \text{ mm}\cdot\text{h}^{-1}$ , based on 10-min intervals. During the peaks of the two events on 6 June, wind speed was rather high ( $> 10 \text{ m}\cdot\text{s}^{-1}$ ; see Fig. 6), with the wind blowing from the NW. The event on 5 June was less turbulent, with wind speeds below  $5 \text{ m}\cdot\text{s}^{-1}$ . The other four events were of minor importance, with rain values of less than 10 mm and intensities below  $3 \text{ mm}\cdot\text{h}^{-1}$ .

With respect to the splash drift, it is particularly the 10-min event around 21 h on 6 June that is important, and to a lesser extent, the secondary event around 10.30 h on 6 June.

### 5. Results and discussion

To obtain a general idea of the vertical profile of the horizontal splash drift and its variation over the test field, we first calculated the average profile by averaging, for each height, the amounts of horizontal splash drift that were measured by the 45 plots. Figure 7 shows the profile up to a height of 100 cm (recall that no sediment was caught by the MWACs at 200 cm). The sharp decrease (as a function of height) of the horizontal splash drift is prominent, but the spread in the data is large, indicating large differences (up to 37 times) between the plots. Average maximum splash drift height is almost 80 cm, but again there are differences between the plots. At several plots, slightly negative splash val-

ues were measured at the highest levels due to sampling problems. In general, the accuracy of the measurements is around  $\pm 0.05 \text{ g}\cdot\text{cm}^{-2}$  (see Fig. 7).

To investigate the large variation in splash drift between the plots, we first characterise the splash drift profile by means of two parameters: the total horizontal splash drift for the whole plot, and the rate of decrease of the splash drift with height.

In the literature, very little information is provided with respect to the splash drift profile. It is usually assumed that the splash profile is best described by an exponential function:

$$G = a \cdot e^{bz} \tag{1}$$

where  $G$  is the total mass of sediment splashed up to a height  $z$  and  $a$  and  $b$  are empirical parameters [7, 27]. However, statistical analysis of the Grönheim data revealed that they are much better described by a power function of the form:

$$G = a \cdot z^b \tag{2}$$

than by an exponential function. Not only is the correlation much higher when using the power function (42 out of the 45 plots), but a power function is more logical since many aeolian sediment concentration and transport profiles are also best described by power functions [3, 11, 16]. To obviate problems with slightly negative  $G$ -values at higher levels (as indicated earlier), the splash profile can also be calculated in the form:

$$G = c \cdot z^b - 1 \tag{3}$$

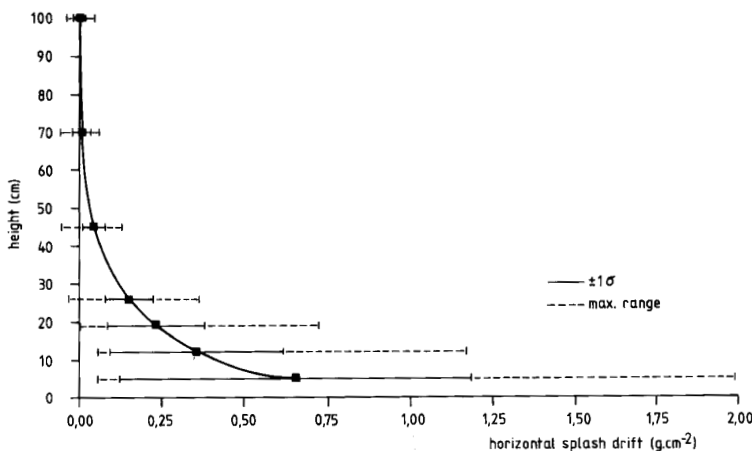

**Figure 7.** Average horizontal splash drift profile. Standard deviation and range of data are also shown; (—)  $\pm 1\sigma$ ; (---) max. range.

where  $c$  is another empirical parameter and the exponent  $b$  is equal to the one in the original power equation (2).

The exponent  $b$  describes the rate of splash drift decrease with height. The other parameter describing the profile, the total horizontal splash drift for the whole plot ( $S$ ), is calculated by integrating the profile from ground-level to the maximum splash drift height ( $h$ ):

$$S = \int_0^h (c \cdot z^b - 1 + p) dz$$

$$= c(b + 1)^{-1} \cdot (h)^{b+1} + h(p - 1) \quad (4)$$

where  $p$  is the (possible) negative value of  $G$  that might be observed at height  $h$  in the fitted splash profile (due to measuring errors, as mentioned earlier). If there are no negative  $G$ -values,  $p$  is equal to zero.  $S$  represents the total mass of sediment passing through a unit length perpendicular to the wind direction.

Table I shows the parameters  $S$  and  $b$  for the 45 plots.  $S$  varies from less than  $5 \text{ g}\cdot\text{cm}^{-1}$  (plot No. 7) to more than  $49 \text{ g}\cdot\text{cm}^{-1}$  (plot No. 13), whereas  $b$  varies from  $-0.021$  (plot No. 7) to  $-0.185$  (plot No. 20).

The large spread in splash drift characteristics between the plots can be caused by differences in the properties of the topsoil, by spatial differences in the meteorological parameters (rain and wind) during the experiment, by the topographical position of the plots, or by a combination of two or more of these factors. Topography may affect the magnitude of splash drift because it has a considerable effect on the speed of the wind near the surface (resulting in higher (or lower) horizontal splash drift compared to flat terrain) and also because it affects the angle of impact of the raindrops relative to the soil surface. Between 3 and 11 June 1998, wind direction during the heavy splash drift events was NW to W (Fig. 6). As can be seen in Figure 2A, surface winds (in the splash zone) during these events should have been highest on the upper part of the northern slope of the valley (for NW winds) and, to a lesser extent, in the valley head and on the upper part of the southern valley slope (for W winds). Looking at the splash drift amounts in Table I, we observe that the highest drifts ( $S > 30 \text{ g}\cdot\text{cm}^{-2}$ ) almost exclusively occur on the plateaus (plots No. 13, 19, 20, 23, 24, 40) or near plateau borders (plot No. 27). All windward slopes are characterised by low splash drift amounts (Tab. I), except

**Table I.** Total horizontal splash drift ( $S$ ) and rate of vertical decrease of splash drift ( $b$ ) for the 45 plots ( $R^2$  is the coefficient of determination).

Plot No.	$S$ ( $\text{g}\cdot\text{cm}^{-1}$ )	$b$	$R^2$	Plot No.	$S$ ( $\text{g}\cdot\text{cm}^{-1}$ )	$b$	$R^2$	Plot No.	$S$ ( $\text{g}\cdot\text{cm}^{-1}$ )	$b$	$R^2$
1	19.959	-0.083	0.960	16	15.125	-0.064	0.904	31	24.950	-0.102	0.731
2	12.195	-0.052	0.870	17	11.041	-0.047	0.699	32	14.064	-0.059	0.912
3	14.709	-0.064	0.845	18	16.366	-0.069	0.671	33	13.314	-0.056	0.937
4	12.316	-0.053	0.750	19	48.582	-0.181	0.852	34	24.677	-0.099	0.819
5	22.591	-0.094	0.970	20	45.643	-0.185	0.819	35	23.445	-0.098	0.901
6	18.500	-0.077	0.801	21	11.839	-0.050	0.472	36	6.239	-0.027	0.904
7	4.825	-0.021	0.733	22	20.484	-0.087	0.824	37	12.107	-0.052	0.943
8	7.582	-0.033	0.899	23	31.523	-0.132	0.721	38	15.875	-0.069	0.743
9	25.739	-0.107	0.943	24	47.975	-0.183	0.762	39	11.080	-0.048	0.974
10	14.339	-0.060	0.897	25	9.534	-0.041	0.854	40	33.795	-0.139	0.901
11	8.139	-0.035	0.837	26	17.464	-0.074	0.972	41	20.850	-0.090	0.160
12	22.989	-0.096	0.939	27	48.273	-0.184	0.815	42	18.616	-0.079	0.956
13	49.380	-0.183	0.839	28	22.452	-0.094	0.949	43	8.586	-0.037	0.416
14	12.927	-0.055	0.776	29	6.302	-0.028	0.716	44	20.245	-0.091	0.949
15	10.377	-0.044	0.852	30	47.191	-0.180	0.808	45	8.241	-0.036	0.916

Mean values: total horizontal splash drift ( $S$ ):  $20.277 \text{ g}\cdot\text{cm}^{-1}$ ; rate of vertical decrease of splash drift ( $b$ ):  $-0.083$ .

for the plots No. 27 and 30. The effect of the impact angle is more difficult to assess since oblique rains transfer less energy to the soil than vertical rains, but stimulate the downwind displacement (by splash) of soil particles. If the impact angle plays a crucial role, then the splash amounts on the plateau in the southern part of the test field should have been more or less comparable, which is clearly not the case (see Tab. I). Topography, therefore, does not seem to be the crucial factor explaining the splash drift pattern in Grönheim. It can further be mentioned that there are no obstacles in the area W (i.e., upwind) of the test field which could have affected the wind field (or the sediment fluxes) during the splash drift events.

To investigate the influence of the topsoil characteristics, three soil parameters were selected: median grain size ( $D_{50}$ ), the fraction silt + clay (i.e., grains  $< 63 \mu\text{m}$ ), and organic matter content. Cross-correlations were calculated between these three soil factors on the one hand and the splash drift factors S and b on the other hand (Tab. II). There is no relationship between the topsoil characteristics and the splash drift: for all six combinations investigated, correlation coefficients are very close to zero. Hence, the spatial differences in splash drift observed in Grönheim are not related to differences in the properties of the topsoil.

For topsoils with a dominance of textural porosity such as the sandy soil in Grönheim, texture (and, more particularly, grain-size) largely controls the resistance of the soil material to detachment by raindrop splash. Poesen [18] showed that well-sorted soils with a median grain-size ranging between 90 and 150  $\mu\text{m}$  have the lowest resistance to splash erosion (Fig. 8). For a unit rainfall amount they produce the highest masses of splashed sediment, and the variation in  $D_{50}$  in the Grönheim field ( $D_{50}$

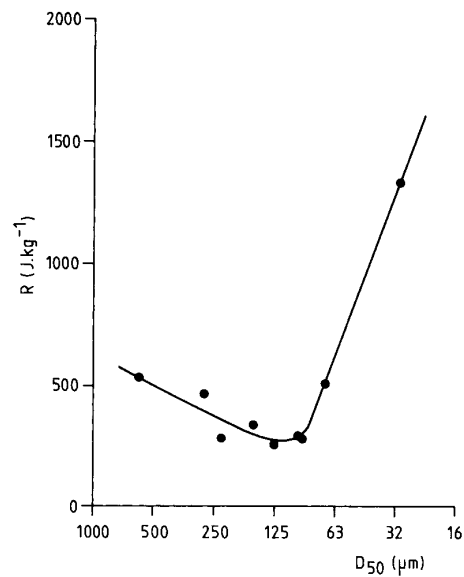

**Figure 8.** Relationship between median grain size ( $D_{50}$ ) of loose sediments and their mean resistance (R) to raindrop detachment (modified from [18]).

always between 100 and 154  $\mu\text{m}$ ) does not have any significant impact upon the splash quantities (see Fig. 8). Because of the dominance of the sand fraction in the Grönheim soil (usually  $> 70\%$ ; see Fig. 3) the other parameters (silt + clay content and organic matter) have little effect on S.

Since neither the topographic position, nor the topsoil properties explain the differences in splash drift between the plots, it is reasonable to assume that the spread in the data must be caused by local spatial variations in the meteorological parameters, especially wind and rain. In the Grönheim case, the effect of the wind is presumably less important than the effect of the rain. Due to the very high concentration of raindrops (original rain + splashed-up droplets) in the splash layer, much of

**Table II.** Correlations between sediment properties and splash drift characteristics. All correlation coefficients are close to zero, indicating no relationship between the parameters.

Splash drift	Grain-size $D_{50}$ ( $\mu\text{m}$ )	Silt + clay Fraction $< 63 \mu\text{m}$ (%)	Organic matter Content (%)
Total splash drift ( $\text{g.cm}^{-1}$ )	0.04	-0.07	0.09
Exponent b	-0.03	0.05	0.09

the wind's energy is transferred to the raindrops. This causes a significant reduction of wind speed and (especially) turbulence in the splash zone. Moreover, most soil particles are transported by splash droplets with diameters in the range 200–1000  $\mu\text{m}$  [33]. Such droplets are usually airborne for less than a second, and they are also too large to be seriously affected by turbulence [1]. Therefore we consider that local variations in the characteristics of the wind probably had only a minor effect on the variations in the splash drift. The local variation in rainfall might be a more important parameter, as has already been suggested by Shaw [26]. Earlier studies [6, 19] have shown that local variation in rainfall within a field during one and the same rain shower can be very high, especially during heavy rains. Since there are no data available with respect to the spatial variation of the rainfall characteristics in the Grönheim field, this assumption cannot be verified for the Grönheim experiment however.

Although there are difficulties in explaining the spatial pattern of the splash drift amount, it is possible to predict fairly accurately the total splash drift  $S$ . In the splash transport model proposed by Poesen [18] it is shown that:

$$S = s \cdot d \quad (5)$$

where  $s$  is the mass of sediment detached per surface unit ( $\text{kg} \cdot \text{m}^{-2}$ ) for a given rain period and  $d$  is the mean weighed splash transport distance (m) in a given direction on a horizontal soil surface. The mass of sediment  $s$  can be calculated from the equation:

$$s = (E_k)/R \quad (6)$$

where  $E_k$  is the kinetic energy of the rain ( $\text{J} \cdot \text{m}^{-2}$ ) and  $R$  is the resistance of the topsoil to detachment by raindrop impact ( $\text{J} \cdot \text{kg}^{-1}$ ).

Although no detailed information about the rainfall intensity causing the splash drift in Grönheim is known, an assessment of  $E_k$  can be made by:

$$E_k = (M \cdot v^2)/2 \quad (7)$$

where  $M$  is the mass of rain per soil surface unit ( $\text{kg} \cdot \text{m}^{-2}$ ) and  $v$  is the terminal fall velocity of the raindrops ( $\text{m} \cdot \text{s}^{-1}$ ).

During the measuring period, a total of 77.0 mm rain was recorded. Assuming this rain mass to fall with a mean terminal fall velocity of  $6 \text{ m} \cdot \text{s}^{-1}$  (which corresponds to the terminal velocity of a median drop having a diameter of 1.6 mm [13], which is a typical median value for late spring or early summer rains in NW Europe) the corresponding kinetic rain energy equals  $1386 \text{ J} \cdot \text{m}^{-2}$ .

When wet, a fine sandy topsoil similar to that in Grönheim has an  $R$ -value of about  $170 \text{ J} \cdot \text{kg}^{-1}$  and  $d$  is approximately 0.14 m [18].

Substituting these  $E_k$ ,  $R$  and  $d$ -values in the equations (6) and (5) results in an  $S$ -value of  $1.123 \text{ kg} \cdot \text{m}^{-1}$ , or  $11.2 \text{ g} \cdot \text{cm}^{-1}$ . This value is of the same order of magnitude as the  $S$ -values measured in the field (average field value:  $20 \text{ g} \cdot \text{cm}^{-1}$ ; range:  $5\text{--}49 \text{ g} \cdot \text{cm}^{-1}$ ).

The fact that the calculated  $S$ -value is somewhat lower than the observed  $S$ -values can be attributed to three facts:

1) kinetic energy was calculated assuming vertical rain. If, during the rain, wind velocity is different from zero (such as in the Grönheim experiment), the resultant terminal fall velocity of the raindrops will be higher compared to vertical rain [17];

2) the calculated  $d$ -value is for vertical rain too. Obviously, when the rain is wind-driven,  $d$  will be larger (because of the wind drift of the splashed particles). However, no experimental data are presently available to predict  $d$ -values for wind-driven splash;

3) because of the high wind speeds during the periods of maximum rain, the rainfall amounts recorded by the rain gauge are an underestimation of the real rain amounts (see [24] for a more detailed discussion of this topic).

It can be reasonably assumed that, in the calculation, both  $d$  and  $E_k$  have been underestimated because of the assumption of vertical rain hitting a horizontal soil surface whereas in the field, the rain was oblique (since it was wind-driven). This explains why the  $S$ -values measured in the field are somewhat larger than those calculated from the model.

## 6. Conclusions

The Grönheim experiment showed that the vertical splash drift profile is best described by a power function of the form  $G = a \cdot z^b$  (or, alternatively,  $G = c \cdot z^b - 1$ ), where  $G$  is the total mass of sediment splashed up to a height  $z$  and  $a$ ,  $b$  and  $c$  are empirical parameters. The experiment also showed that, within a same field, the rate of decrease of  $G$  with height (represented by the exponent  $b$ ) is highly variable. Similarly the total horizontal splash drift  $S$  for a plot (i.e., the vertically integrated sediment mass passing through a unit length perpendicular to the wind) varies significantly within a field, even during one and the same rain event. There is no clear relationship between these spatial variations and topographic position or the properties of the topsoil. The spatial variations in splash drift are presumably caused by spatial variations in the rainfall (especially rainfall intensity) during the rain events. Such spatial differences in rainfall can be very important, even at very short distances, as has been shown earlier [6, 19].

The total horizontal splash drift  $S$  can be fairly well predicted using the theoretical splash transport model developed by Poesen [18]. The measured splash drift amounts are somewhat higher, but of the same order of magnitude as the predicted ones. The main reason for the underestimation of the splash drift values is that the splash transport model has been developed for vertical rains whereas in the Grönheim experiment, the raindrops impacted obliquely. The numerical difference between the measured and the predicted splash drift amounts gives a good indication of the significance of the inclination of the rain with respect to the process of hydraulic splash.

## References

- [1] Anderson R.S., Eolian sediment transport as a stochastic process: the effects of a fluctuating wind on particle trajectories, *J. Geol.* 95 (1987) 497–512.
- [2] Bagnold R.A., *The Physics of Blown Sand and Desert Dunes*, Methuen, London, 1941.
- [3] Chepil W.S., Woodruff N.P., Sedimentary characteristics of dust storms: II. Visibility and dust concentration, *Am. J. Sci.* 255 (1957) 104–114.
- [4] De Lima J.L.M.P., van Dijk P.M., Spaan W.P., Splash-saltation transport under wind-driven rain, *Soil Technol.* 5 (1992) 151–166.
- [5] De Ploey J., Some field measurements and experimental data on wind-blown sands, in: M. De Boodt, D. Gabriëls (Eds.), *Assessment of Erosion*, Wiley, Chichester, UK, 1980, pp. 143–151.
- [6] Evenari M., *Runoff-Farming in the Negev Desert of Israel (5th Progress Report). Part II: General Developments*, Dept. of Botany, Hebrew Univ. Jerusalem, 1979.
- [7] Foster G.R., White G.C., Hakonson T.E., Dreicer M., A model for splash and retention of sediment and soil-borne contaminants on plants, *Trans. ASAE* 28 (1985) 1511–1520.
- [8] Gabriëls D., Tack K., Erpul G., Cornelis W.M., Norton D., Biesemans J., Effect of wind-driven rain on splash detachment and transport of a silt loam soil: a short slope wind-tunnel experiment, in: *Proc. Int. Workshop on Technical Aspects and Use of Wind Tunnels for Wind-Erosion Control. Combined Effect of Wind and Water on Erosion Processes*, Int. Centre Eremology, Univ. Ghent, 1998, pp. 87–93.
- [9] Ghadiri H., Payne D., A study of soil splash using cinephotography, in: M. De Boodt, D. Gabriëls (Eds.), *Assessment of Erosion*, Wiley, Chichester, UK, 1980, pp. 185–192.
- [10] Gilley J.E., Finkner S.C., Estimating soil detachment caused by raindrop impact, *Trans. ASAE* 28 (1985) 140–146.
- [11] Goossens D., Meteorological and sedimentological analysis of the severe dust storm in the Negev desert on 2 November 1994, *J. Meteorol.* 21 (1996) 273–286.
- [12] Jungerius P.D., Verheggen A.J.T., Wiggers A.J., The development of blowouts in 'De Blink', a coastal dune area near Noordwijkerhout, The Netherlands, *Earth Surf. Processes and Landforms* 6 (1981) 375–396.
- [13] Laws J.O., Measurement of the fall-velocity of water-drops and raindrops, *Trans. Am. Geophys. Union* 22 (1941) 709–721.
- [14] Moeyersons J., Measurements of splash-saltation fluxes under oblique rain, *Catena Suppl.* 4 (1983) 19–31.
- [15] Mutchler C., Young R., Soil detachment by raindrops, in: *Present and Prospective Technology for*

Predicting Sediment Yields and Sources, Agric. Res. Serv. Rep. ARS-S-40, 1975, pp. 113–117.

- [16] Nickling W.G., Eolian sediment transport during dust storms: Slims River Valley, Yukon Territory, Can. J. Earth Sci. 15 (1978) 1069–1084.
- [17] Pedersen H.S., Hasholt B., Influence of wind speed on rainsplash erosion, Catena 24 (1995) 39–54.
- [18] Poesen J., An improved splash transport model, Z. Geomorphol. 29 (1985) 193–211.
- [19] Poesen J., Field measurements of splash erosion to validate a splash transport model, Z. Geomorphol. 58 (1986) 81–91.
- [20] Poesen J., Savat J., Detachment and transportation of loose sediments by raindrop splash. Part II: Detachability and transportability measurements, Catena 8 (1981) 19–41.
- [21] Poesen J., Torri D., The effect of cup size on splash detachment and transport measurements. Part I: Field measurements, Catena (Suppl.) 12 (1988) 113–126.
- [22] Poreh M., Mechrez E., The combined effect of wind and topography on rainfall distribution, J. Hydrol. 72 (1984) 1–23.
- [23] Rutin J., Erosional Processes on a Coastal Sand Dune, De Blink, Noordwijkerhout, Laboratory of Physical Geography and Soil Science, Univ. Amsterdam, The Netherlands, 1983.
- [24] Sevruk B., Hertig J.-A., Spiess R., The effect of a precipitation gauge orifice rim on the wind field deformation as investigated in a wind tunnel, Atmos. Environ. 25A (1991) 1173–1179.
- [25] Sharma P.P., Gupta S.C., Rawls W.J., Soil detachment by single raindrops of varying kinetic energy, Soil Sci. Soc. Am. J. 55 (1991) 301–307.
- [26] Shaw M.W., Assessment of upward movement of rain splash using a fluorescent tracer method and its application to the epidemiology of cereal pathogens, Plant Pathol. 36 (1987) 201–213.
- [27] Shaw M.W., Variation in the height to which tracer is moved by splash during natural summer rain in the UK, Agric. For. Meteorol. 55 (1991) 1–14.
- [28] Torri D., Poesen J., The effect of soil surface slope on raindrop detachment, Catena 19 (1992) 561–578.
- [29] Ungar J., Haff P.K., Steady state saltation in air, Sedimentology 34 (1987) 289–299.
- [30] van Asch T, Roels J., Een beginpoging tot het opstellen van een splashmodel en de resultaten van enkele metingen, Berichten Fysisch Geografische Afdeling der R.U. Utrecht 12 (1979) 59–69.
- [31] van Dijk P.M., Stroosnijder L., de Lima J.L.M.P., The influence of rainfall on transport of beach sand by wind, Earth Surf. Processes and Landforms 21 (1996) 341–352.
- [32] Van Heerden W.M., Splash erosion as affected by the angle of incidence of raindrop impact, PhD thesis, Purdue Univ., West-Lafayette, Ind., USA, 1964.
- [33] Walklate P.J., Vertical dispersal of plant pathogens by splashing. Part I: The theoretical relationship between rainfall and upward rain splash, Plant Pathol. 38 (1989) 56–63.
- [34] Willetts B.B., Rice M.A., Collisions of quartz grains with a sand bed: the influence of incident angle, Earth Surf. Processes and Landforms 14 (1989) 719–730.
- [35] Wilson S.J., Cooke R.U., Wind erosion, in: M.J. Kirkby, R.P.C. Morgan (Eds.), Soil Erosion, Wiley, Chichester, UK, 1980, pp. 217–251.