



**HAL**  
open science

## An experimental study on the effects of lubrication in form tapping

Guillaume Fromentin, Aleksandra Bierla, Clotilde Minfray, Gérard Poulachon

► **To cite this version:**

Guillaume Fromentin, Aleksandra Bierla, Clotilde Minfray, Gérard Poulachon. An experimental study on the effects of lubrication in form tapping. *Tribology International*, 2010, 43, pp.1726-1734. 10.1016/j.triboint.2010.04.005 . hal-00880327

**HAL Id: hal-00880327**

**<https://hal.science/hal-00880327>**

Submitted on 5 Nov 2013

**HAL** is a multi-disciplinary open access archive for the deposit and dissemination of scientific research documents, whether they are published or not. The documents may come from teaching and research institutions in France or abroad, or from public or private research centers.

L'archive ouverte pluridisciplinaire **HAL**, est destinée au dépôt et à la diffusion de documents scientifiques de niveau recherche, publiés ou non, émanant des établissements d'enseignement et de recherche français ou étrangers, des laboratoires publics ou privés.



## Science Arts & Métiers (SAM)

is an open access repository that collects the work of Arts et Métiers ParisTech researchers and makes it freely available over the web where possible.

This is an author-deposited version published in: <http://sam.ensam.eu>  
Handle ID: <http://hdl.handle.net/10985/7461>

### To cite this version :

Guillaume FROMENTIN, Aleksandra BIERLA, Clotilde MINFRAY, Gérard POULACHON - An experimental study on the effects of lubrication in form tapping - Tribology international - Vol. 43, p.1726-1734 - 2010

Any correspondence concerning this service should be sent to the repository

Administrator : [archiveouverte@ensam.eu](mailto:archiveouverte@ensam.eu)

# An experimental study on the effects of lubrication in form tapping

G. Fromentin (1), A. Bierla (1), C. Minfray (2), G. Poulachon (1)

(1) LaBoMaP, Arts et Metiers ParisTech Cluny, Rue porte de Paris, F-71250 Cluny,  
France

(2) LTDS, Ecole Centrale de Lyon, 36 avenue Guy de Collongue, F-69134 Ecully Cedex,  
France

Corresponding author:

Guillaume FROMENTIN, Arts et Metiers ParisTech Cluny, Rue Porte de Paris, F-71250 CLUNY, FRANCE, Tel.: + 33 385 595 330, Fax: + 33 385 595 370, email:

[guillaume.fromentin@ensam.eu](mailto:guillaume.fromentin@ensam.eu)

**Abstract:** This paper presents the results of a study of lubrication in form tapping and aims at a better understanding of its effect. It appears that lubrication is of paramount importance. Oil with efficient high pressure additives can reduce considerably the torque necessary to form the thread. Lubricants reduce the tool / work material friction during the forming process and, as a consequence, the resulting strain distribution and the strain hardening of the thread are affected. This investigation includes an analysis on the effects of additives in lubricants on the temperature during tapping, enabling correlation with the appearance of chemical elements of the oil which react with the thread material and contribute to lubrication.

**Key words:** Metal working Fluids; Form tapping; Additives Performance Testing

*Ms. Ref. No.: TRIBINT-D-09-00062*

*Title: An experimental study on the effects of lubrication in form tapping  
Tribology International*

Corresponding author:

Guillaume FROMENTIN, Arts et Metiers ParisTech Cluny, Rue Porte de Paris, F-71250

CLUNY, FRANCE, Tel.: + 33 385 595 330, Fax: + 33 385 595 370,

email: [guillaume.fromentin@ensam.eu](mailto:guillaume.fromentin@ensam.eu)

### **Answer to reviewers:**

Reviewers comments were taken into account and the modifications incorporated in the article.

Nevertheless one remark from 1<sup>st</sup> review was not understood. Our study duly shows that results from tapping test and metallurgical analysis are coherent. The higher the tapping torque is the more strain hardening is appeared. Effectively it also shows that sulphur percentage on thread surface, analyzed by EDS, cannot be correlated to MFW friction reducing performance. It is understandable because this analysis only characterized chemical composition of tribological film. **Then we complete our study with introducing XPS analysis in order to debate on chemical compounds of sulphured layer (sulphide or sulphate).** Two new authors have also been added.

I would like to mention that, concerning the form tapping test, it allow discriminating MFW which cannot be by cut tapping.

About “formation torque”, it is named like this because is the torque needed for the thread formation. I think if we named it “forming torque”, it may be confused with tapping torque in form tapping.

The conclusion was also modified for more details.

I must acknowledge the painstaking efforts of the reviewers for the reviewing the article. I thank them for improving the understanding of the paper. I think the additions and modifications made in the article address all issues raised by the esteemed reviewers.

1  
2  
3  
4  
5  
6  
7  
8  
9  
10  
11  
12  
13  
14  
15  
16  
17  
18  
19  
20  
21  
22  
23  
24  
25  
26  
27  
28  
29  
30  
31  
32  
33  
34  
35  
36  
37  
38  
39  
40  
41  
42  
43  
44  
45  
46  
47  
48  
49  
50  
51  
52  
53  
54  
55  
56  
57  
58  
59  
60  
61  
62  
63  
64  
65

# An experimental study on the effects of lubrication in form tapping

G. Fromentin (1), A. Bierla (1), C. Minfray (2), G. Poulachon (1)

(1) LaBoMaP, Arts et Metiers ParisTech Cluny, Rue porte de Paris, F-71250 Cluny,  
France

(2) LTDS, Ecole Centrale de Lyon, 36 avenue Guy de Collongue, F-69134 Ecully  
Cedex, France

## Corresponding author:

Guillaume FROMENTIN, Arts et Metiers ParisTech Cluny, Rue Porte de Paris, F-71250 CLUNY, FRANCE, Tel.: + 33 385 595 330, Fax: + 33 385 595 370, email: [guillaume.fromentin@ensam.eu](mailto:guillaume.fromentin@ensam.eu)

**Abstract:** This paper presents the results of a study of lubrication in form tapping and aims at a better understanding of its effect. It appears that lubrication is of paramount importance. Oil with efficient high pressure additives can reduce considerably the torque necessary to form the thread. Lubricants reduce the tool / work material friction during the forming process and, as a consequence, the resulting strain distribution and the strain hardening of the thread are affected. This investigation includes an analysis on the effects of additives in lubricants on the temperature during tapping, enabling correlation with the appearance of chemical elements of the oil which react with the thread material and contribute to lubrication.

**Key words:** Metal working Fluids; Form tapping; Additives Performance Testing

## 1. Introduction

1 Form tapping is a thread forming process used more and more in manufacturing. This  
2 process is very interesting and economically beneficial compared to cut tapping because it  
3 leads to much longer tool life, improved reliability, and better cleanliness (no chip).  
4 Although form tapping has existed for decades, very few studies have been published on  
5 the subject. The interest in this process is growing, due to its importance for the  
6 manufacturing industry, particularly in the automotive sector. Thus, new and advanced  
7 research on this process is significant.  
8

9  
10  
11  
12  
13  
14 During form tapping, the thread is formed by displacing of the work material, whereas in  
15 cut tapping it is created by chip removal. Therefore, the internally formed thread is  
16 characterized by the split crest at its top, as shown later. The thread percentage depends  
17 on the hole diameter. A. Agapiou [1] gives an analytical formula for this relationship. The  
18 smaller the hole diameter, the higher the thread percentage. Thus, the procedure needs  
19 higher torque, and it is necessary to monitor and control the hole making operation in order  
20 to avoid tool breakage. Thread formers are mostly sintered high speed steel taps with  
21 appropriate treatments and coatings to produce the required and favourable  
22 characteristics of toughness and hardness. They are designed with lobes which make  
23 them more difficult to grind and they have no flute which makes them less brittle. The  
24 complicated geometry of these thread formers has lead to several studies [2-4]. Also, the  
25 work material has to be ductile enough to be thread formed, and most studies deal with  
26 non ferrous alloys [1,5-6]. Nevertheless, hardened steel can be thread formed [4,7-8]. In  
27 this case, from the economic point of view, form tapping, due to longer tool life, is much  
28 more beneficial than cut tapping. Analytical models for the thread forming process have  
29 also been proposed [5-6,9]. However, they show a lack of knowledge about friction  
30 between the tool and the work material. A thorough understanding of frictional conditions is  
31 important in thread forming to achieve a correct use of fluids as lubricants, coolants, or  
32 both.  
33

34  
35  
36  
37  
38  
39  
40  
41  
42  
43  
44  
45  
46  
47  
48  
49 Tapping is a very harsh machining process that is quite sensitive to lubrication or cooling.  
50 Thus, the tapping test has been proposed as a standard test [10,11] for cutting fluid  
51 evaluation and comparison.  
52

53  
54  
55  
56  
57  
58  
59  
60  
61  
62  
63  
64  
65  
66  
67  
68  
69  
70  
71  
72  
73  
74  
75  
76  
77  
78  
79  
80  
81  
82  
83  
84  
85  
86  
87  
88  
89  
90  
91  
92  
93  
94  
95  
96  
97  
98  
99  
100  
101  
102  
103  
104  
105  
106  
107  
108  
109  
110  
111  
112  
113  
114  
115  
116  
117  
118  
119  
120  
121  
122  
123  
124  
125  
126  
127  
128  
129  
130  
131  
132  
133  
134  
135  
136  
137  
138  
139  
140  
141  
142  
143  
144  
145  
146  
147  
148  
149  
150  
151  
152  
153  
154  
155  
156  
157  
158  
159  
160  
161  
162  
163  
164  
165  
166  
167  
168  
169  
170  
171  
172  
173  
174  
175  
176  
177  
178  
179  
180  
181  
182  
183  
184  
185  
186  
187  
188  
189  
190  
191  
192  
193  
194  
195  
196  
197  
198  
199  
200  
201  
202  
203  
204  
205  
206  
207  
208  
209  
210  
211  
212  
213  
214  
215  
216  
217  
218  
219  
220  
221  
222  
223  
224  
225  
226  
227  
228  
229  
230  
231  
232  
233  
234  
235  
236  
237  
238  
239  
240  
241  
242  
243  
244  
245  
246  
247  
248  
249  
250  
251  
252  
253  
254  
255  
256  
257  
258  
259  
260  
261  
262  
263  
264  
265  
266  
267  
268  
269  
270  
271  
272  
273  
274  
275  
276  
277  
278  
279  
280  
281  
282  
283  
284  
285  
286  
287  
288  
289  
290  
291  
292  
293  
294  
295  
296  
297  
298  
299  
300  
301  
302  
303  
304  
305  
306  
307  
308  
309  
310  
311  
312  
313  
314  
315  
316  
317  
318  
319  
320  
321  
322  
323  
324  
325  
326  
327  
328  
329  
330  
331  
332  
333  
334  
335  
336  
337  
338  
339  
340  
341  
342  
343  
344  
345  
346  
347  
348  
349  
350  
351  
352  
353  
354  
355  
356  
357  
358  
359  
360  
361  
362  
363  
364  
365  
366  
367  
368  
369  
370  
371  
372  
373  
374  
375  
376  
377  
378  
379  
380  
381  
382  
383  
384  
385  
386  
387  
388  
389  
390  
391  
392  
393  
394  
395  
396  
397  
398  
399  
400  
401  
402  
403  
404  
405  
406  
407  
408  
409  
410  
411  
412  
413  
414  
415  
416  
417  
418  
419  
420  
421  
422  
423  
424  
425  
426  
427  
428  
429  
430  
431  
432  
433  
434  
435  
436  
437  
438  
439  
440  
441  
442  
443  
444  
445  
446  
447  
448  
449  
450  
451  
452  
453  
454  
455  
456  
457  
458  
459  
460  
461  
462  
463  
464  
465  
466  
467  
468  
469  
470  
471  
472  
473  
474  
475  
476  
477  
478  
479  
480  
481  
482  
483  
484  
485  
486  
487  
488  
489  
490  
491  
492  
493  
494  
495  
496  
497  
498  
499  
500  
501  
502  
503  
504  
505  
506  
507  
508  
509  
510  
511  
512  
513  
514  
515  
516  
517  
518  
519  
520  
521  
522  
523  
524  
525  
526  
527  
528  
529  
530  
531  
532  
533  
534  
535  
536  
537  
538  
539  
540  
541  
542  
543  
544  
545  
546  
547  
548  
549  
550  
551  
552  
553  
554  
555  
556  
557  
558  
559  
560  
561  
562  
563  
564  
565  
566  
567  
568  
569  
570  
571  
572  
573  
574  
575  
576  
577  
578  
579  
580  
581  
582  
583  
584  
585  
586  
587  
588  
589  
590  
591  
592  
593  
594  
595  
596  
597  
598  
599  
600  
601  
602  
603  
604  
605  
606  
607  
608  
609  
610  
611  
612  
613  
614  
615  
616  
617  
618  
619  
620  
621  
622  
623  
624  
625  
626  
627  
628  
629  
630  
631  
632  
633  
634  
635  
636  
637  
638  
639  
640  
641  
642  
643  
644  
645  
646  
647  
648  
649  
650  
651  
652  
653  
654  
655  
656  
657  
658  
659  
660  
661  
662  
663  
664  
665  
666  
667  
668  
669  
670  
671  
672  
673  
674  
675  
676  
677  
678  
679  
680  
681  
682  
683  
684  
685  
686  
687  
688  
689  
690  
691  
692  
693  
694  
695  
696  
697  
698  
699  
700  
701  
702  
703  
704  
705  
706  
707  
708  
709  
710  
711  
712  
713  
714  
715  
716  
717  
718  
719  
720  
721  
722  
723  
724  
725  
726  
727  
728  
729  
730  
731  
732  
733  
734  
735  
736  
737  
738  
739  
740  
741  
742  
743  
744  
745  
746  
747  
748  
749  
750  
751  
752  
753  
754  
755  
756  
757  
758  
759  
760  
761  
762  
763  
764  
765  
766  
767  
768  
769  
770  
771  
772  
773  
774  
775  
776  
777  
778  
779  
780  
781  
782  
783  
784  
785  
786  
787  
788  
789  
790  
791  
792  
793  
794  
795  
796  
797  
798  
799  
800  
801  
802  
803  
804  
805  
806  
807  
808  
809  
810  
811  
812  
813  
814  
815  
816  
817  
818  
819  
820  
821  
822  
823  
824  
825  
826  
827  
828  
829  
830  
831  
832  
833  
834  
835  
836  
837  
838  
839  
840  
841  
842  
843  
844  
845  
846  
847  
848  
849  
850  
851  
852  
853  
854  
855  
856  
857  
858  
859  
860  
861  
862  
863  
864  
865  
866  
867  
868  
869  
870  
871  
872  
873  
874  
875  
876  
877  
878  
879  
880  
881  
882  
883  
884  
885  
886  
887  
888  
889  
890  
891  
892  
893  
894  
895  
896  
897  
898  
899  
900  
901  
902  
903  
904  
905  
906  
907  
908  
909  
910  
911  
912  
913  
914  
915  
916  
917  
918  
919  
920  
921  
922  
923  
924  
925  
926  
927  
928  
929  
930  
931  
932  
933  
934  
935  
936  
937  
938  
939  
940  
941  
942  
943  
944  
945  
946  
947  
948  
949  
950  
951  
952  
953  
954  
955  
956  
957  
958  
959  
960  
961  
962  
963  
964  
965  
966  
967  
968  
969  
970  
971  
972  
973  
974  
975  
976  
977  
978  
979  
980  
981  
982  
983  
984  
985  
986  
987  
988  
989  
990  
991  
992  
993  
994  
995  
996  
997  
998  
999  
1000

This study deals with the influence of lubricants during thread forming on hardened steel. In order to achieve a clear understanding, several fields of investigation are included:

1 lubricant characterization, tapping forces, temperatures measurements and metallurgical  
2 aspects, and surface analysis on formed thread.  
3  
4  
5  
6

## 7 **2. Characteristics of lubricants**

8  
9 During this study, a total of 9 oils and 2 water-based emulsions from 6 different  
10 manufacturers have been tested in form tapping.  
11

12  
13 These fluids are recommended by their manufacturers as suitable for the tapping process  
14 or forming processes. They contain extreme pressure additives mainly based on either  
15 sulphur or chlorine. Their viscosities are known. In order to identify all chemical additives,  
16 oil is put on a substrate made of aluminium copper alloy and the samples are analysed  
17 with a Scanning Electron Microscope (SEM) equipped with a Energy Dispersive  
18 Spectrometer (EDS). This method does not enable determination of the content of each  
19 element present in different oils, because the intensity of the EDS peak depends mainly on  
20 the thickness of the oil film on the substrate. Nevertheless, ranking of the amount of  
21 different elements within a lubricant can be analysed and they are quoted in Table 1 in  
22 decreasing order. Oils no. 1, 2, 3 & 6 are mentioned as chlorine-free and only oils no. 4,  
23 5 & 7 are chlorinated oils. Fig. 1 shows the spectrum of oil no. 3; except for the Al and Cu  
24 peaks due to the substrate, all the other peaks are linked to chemical elements of the oil.  
25

26  
27 The quantities of different elements included in each oil are unknown, and moreover an  
28 element such as sulphur may appear in the oil in different molecules [12,13]. It can be  
29 contained in overbased sulfonates (sodium sulfonate and calcium sulfonate), sulphured-  
30 ester, and/or poly-sulphur. These compositions are only known to the oil manufacturer.  
31 Sulphured or chlorinated additives may react with iron from the worked steel at the contact  
32 surface with the tool, and they may then contribute to lubrication.  
33

34  
35 Concerning the emulsions tested, the concentrates are analysed by the same method.  
36 Two water-based emulsions are investigated, with 5% and 20% oil respectively. The  
37 appearance of potassium is explained by the fact that it is a surface active agent  
38 facilitating the emulsion of oil in water.  
39  
40  
41  
42  
43  
44  
45  
46

## 47 **3. Tapping tests**

### 48 **3.1. Experimental procedure**

49  
50  
51  
52  
53  
54  
55  
56  
57  
58  
59  
60  
61  
62  
63  
64  
65

1 The work material used in this study is C70 carbon steel. Its structure is mostly perlitic due  
2 to the carbon content value, and its ultimate strength is 900 MPa.  
3

4 The tapping experiments were performed on a DMC65V Deckel Maho Gildemeister 3 axis  
5 vertical machining centre equipped with a spindle controlled both in speed and position.  
6 After drilling, a boring operation is performed to calibrate the hole and to achieve an  
7 accurate hole axis straightness. Blind holes are tapped with a semi-rigid holder in order to  
8 reduce axial force due to axis synchronisation errors. The thread former is a M12x1.5 6HX  
9 tap, made of HSS-E and TiN-coated. Its design is composed of 5 lobes and a short entry  
10 taper with 3 pitches. Concerning the tapping conditions, the spindle speed is fixed at 370  
11 rpm in all the tests, which corresponds to a tangential speed of 14 m/min at the nominal  
12 diameter. The hole diameter before tapping is equal to 11.31 mm, which leads to a thread  
13 percentage of 87%.  
14  
15  
16  
17  
18  
19  
20  
21  
22

23 New taps, all coming from the same batch and cleaned with acetone, are used for each  
24 lubricant, and each is tested several times. All cylindrical samples are machined in rolled  
25 bars coming from the same batch, implying that the samples have the same hardness.  
26 The blind hole is filled with the lubricant and the thread former is covered with lubricant  
27 before tapping. During tapping, the torque and the thrust force are measured on the  
28 tapped sample with a 9273 Kistler piezo-electric dynamometer.  
29  
30  
31  
32  
33  
34  
35  
36

### 37 **3.2. Torque measurement analysis**

38 During the form tapping operation the torque varies until the spindle reverses for different  
39 reasons. Fig. 2 shows torque as a function of time, and Fig. 3 shows the tap during  
40 working in a sample at different positions. The torque increases from time  $T_1$  to  $T_2$  when  
41 the entry taper of the tool penetrates the workpiece. At time  $T_2$ , all the lobes of the entry  
42 taper are working the material, and the first thread is completely formed. The value of the  
43 torque at this moment is named the *Formation Torque*. Even beyond  $T_2$ , the torque would  
44 continue to increase due to the increasing contact surface between the workpiece and the  
45 tool resulting from springback of the deformed material. This is the reason why thread  
46 formers are designed with a back clearance angle. The reduction of the tool diameter on  
47 the back taper is a few hundredths of a millimeter for a 10 mm length. At time  $T_3$ , the  
48 spring back of the deformed material is equal to the back clearance of the tap and  
49 consequently the area of the surface contact will not increase beyond  $T_3$ . If the lubricant  
50  
51  
52  
53  
54  
55  
56  
57  
58  
59  
60  
61  
62  
63  
64  
65



1 still remains active, the torque will subsequently remain constant as shown in Fig. 2. And  
2 finally, at time  $T_4$ , the tap stops and travels out of the workpiece, the torque is becoming  
3 negative. The increase of the torque from  $T_2$  to  $T_3$  is called *Friction Torque*. It is clear that  
4 there is friction between the work material and the tool in the entry taper during formation  
5 of the thread by the plastic flow. Nevertheless, the term *Friction Torque* applies to the  
6 torque caused by the contact of the work material with the back taper which is not involved  
7 in the formation of the thread. The *Mean Torque* is calculated during the steady state, from  
8  $T_3$  to  $T_4$ .

### 17 3.3. Effect of lubricant on torque

18 Different tests show that the torque does not always reach and remain at a constant level  
19 even though the area of the contact surface between the tool and the workpiece reaches a  
20 constant value. Fig. 4 shows the comparison of different lubricants used in tapping. The  
21 torque curves for oils no. 2 & 4 and emulsion no. 2 reach a steady-state as seen  
22 previously in Fig. 2 with emulsion no. 1. However, two other scenarios are possible:  
23  
24  
25  
26  
27  
28  
29  
30

- 31 (a) The torque may increase monotonically while the tap is working, as shown in the  
32 curve for oil no. 9. In this case it may be explained by the oil losing its lubrication  
33 due to increased temperature.  
34  
35  
36
- 37 (b) The torque increases under the effect of springback of the deformed material, after  
38 which the torque decreases somewhat to reach a steady-state at a lower mean  
39 torque as seen by the curve with oil no. 1. The oil may need a higher temperature or  
40 more time to allow its additives to react, in order to increase its efficiency.  
41  
42  
43  
44  
45  
46

47 If the torque curve does not reach a steady-state, the *Mean Torque* is calculated from  $T =$   
48  $1.5$  s to  $T_4$ , then the *Friction Torque* is defined in Equation (1).

$$49 \text{Friction Torque} = \text{Mean Torque} - \text{Formation Torque} \quad (1)$$

50  
51  
52  
53  
54  
55 Fig. 4 shows the significance of the lubricant in form tapping. The *Mean Torque* with the  
56 least effective oil, is 53% higher than the *Mean Torque* with the most effective one, i.e., oil  
57 no. 1. Emulsion no. 2 shows a 73% increase compared to oil no. 1. It is seen that an  
58  
59  
60  
61  
62  
63  
64  
65

1 efficient lubricant reduces not only the *Friction Torque* on the back taper of the tool, but  
2 also the *Formation Torque*. This is an interesting point, because the *Formation Torque*  
3 concerns the entry taper, which is the active zone of the tool where the pressures between  
4 the tool and the work material are higher than in the back taper.  
5  
6

7  
8 All results are presented in Fig. 5. Lubricants are ranked from best to worst by considering  
9 the *Mean Torque* as the criterion. This ranking would be a little different if the criterion  
10 taken into account is the *Formation Torque*, the maximum torque, or the tapping energy.  
11  
12

13 The first four lubricants show a decreasing efficiency, where oils no. 5 to no. 7 have a  
14 comparable mean torque and the last four also present a decreasing efficiency. The *Mean*  
15 *Torque* of oil no. 9 is only 10% lower than the emulsion no. 1. Oils with chlorine additives  
16 do not rank well. Chlorinated additives are used less and less due to health and  
17 environmental issues. This means that it is possible to replace chlorinated oils with better  
18 ones. Concerning the emulsions, emulsion no. 1 is a little more efficient although it is a 5%  
19 water-based emulsion against 20% for emulsion no. 2. If the two emulsions are compared  
20 with water, it appears that the emulsions do not have any ability to lubricate during form  
21 tapping of high strength steels.  
22  
23

24 Friction percentage and formation percentage are respectively defined in equations (2)  
25 and (3).  
26  
27

$$28 \text{ \% Friction} = \text{Friction Torque} / \text{Mean Torque} \quad (2)$$

$$29 \text{ \% Formation} = \text{Formation Torque} / \text{Mean Torque} \quad (3)$$

30  
31  
32  
33  
34  
35  
36  
37  
38  
39  
40  
41 All oils reduce *Friction Torque* compared to emulsions; moreover powerful oils decrease  
42 *Formation Torque*. The trend is that the better the oil is, the lower the *Friction* and  
43 *Formation Torque* are, but the *Friction Percentage* rises (i.e., the *Formation Percentage*  
44 decreases). As a result, it appears easier to decrease the friction on the back taper of the  
45 tool than on the entry taper. This may confirm the fact that generally the stresses are much  
46 higher in this second zone. Concerning the lubrication conditions on each lobe of the entry  
47 taper, two hypotheses may be proposed. The first is that efficient oil reduces the force on  
48 each lobe of the entry taper. The second is that it reduces only forces on the first lobes  
49 and not on the last lobes of the entry taper, where stresses would be much higher because  
50 of strain-hardening and higher depth of penetration.  
51  
52  
53  
54  
55  
56  
57  
58  
59  
60  
61  
62  
63  
64  
65

1 It would be interesting to determine which properties of a lubricant make it adequate for  
2 the form tapping process. A simple comparison can be done between the kinetic viscosity  
3 and the *Mean Torque* during tapping. However, as seen in Fig. 6 there is no correlation  
4 between these two measurements. Oil with a viscosity up to 20 mm<sup>2</sup>/s may lead to a low  
5 torque as with oil no. 2, but also to a large torque as shown with oil no. 8. As a result,  
6 additives contained in the oil may have a significant effect on the torque during the forming  
7 operation.

8  
9  
10  
11  
12  
13 In order to confirm this conclusion, the manufacturer of oil no. 2 agreed to produce this oil  
14 with two other values of viscosity. It means that they are made from different base oils but  
15 contain the same additives, as it is recapitulated in Table 2. The torque measurements in  
16 Fig. 7 show that there is no significant difference between these oils. The *Mean Torque* is  
17 the same, only the torque between  $T_2$  and  $T_3$  appears to change a little, which can be  
18 explained by the fact that there is an interaction between the base oil and the additives. As  
19 a consequence, these tests confirm that the viscosity does not influence the torque during  
20 form tapping, and that the additives are the elements responsible for making a successful  
21 oil.

### 3.4. Lubrication and temperature

22  
23  
24  
25  
26  
27  
28  
29  
30  
31  
32  
33  
34 Heat generation and the associated temperature rise in manufacturing processes are  
35 significant topics of research. The rise in temperature leads to thermal softening of the  
36 work material which would be beneficial in manufacturing operations, but too high a  
37 temperature decreases mechanical properties of the tool material, and contributes to its  
38 rapid wear by different mechanisms. The lubricant is also affected by the temperature  
39 which is necessary to make the chemical reaction of additives contained in the oil possible,  
40 but excessive temperatures may cause burning of the oil. Thus, the oil is affected by the  
41 elevated temperature, and the reverse has to be considered. The operating temperatures  
42 are decreased by an efficient lubricant which would considerably reduce friction between  
43 the tool and the work material. This would lead to less energy generated directly by  
44 friction, and the stress distribution being changed, the heat created in the deformed zones  
45 is also reduced.

46  
47  
48  
49  
50  
51  
52  
53  
54  
55  
56  
57  
58  
59  
60  
61  
62  
63  
64  
65  
The mechanical energy applied to the thread former during tapping is considered to be  
entirely converted into heat. This energy  $E$  is calculated by equation (4), where  $\omega$  is the

1 spindle speed (rad/s). Thus, the higher the tapping torque is, the more heat is created.  
2  
3 However, this reasoning does not allow us to know whether the temperature is locally  
4  
5 higher or not.  
6

$$7 \quad E = \int_{T_1}^{T_2} M_z(t) \times \omega \times dt \quad (4)$$

10 Since it is not possible to measure directly the temperature of the lubricant at the tool/work  
11 material interface, it was decided to measure it with a thermocouple (TC1) 1 mm from the  
12 root to the 3<sup>rd</sup> thread, i.e., 4.5 mm from the top of the sample. It is not feasible to place it  
13 close by the root because it would be inside the deformed zone with the risk of being  
14 destroyed. A second thermocouple (TC2) measures the temperature in the oil contained at  
15 the bottom of the tapped sample, as shown in Fig. 8.  
16  
17

18 TC1 measures two maxima in temperature at time 1 s and time 4 s as shown in Fig. 9.  
19 Heat appears mainly in the deformed zones of the work material and at the tool interface  
20 due to friction. Then, the heat is partially transferred to the tool, and another portion is  
21 evacuated by the lubricant which is removed out of the tapped sample. However, most of  
22 the heat is generated and conducted into the work material. The temperature at the  
23 measurement point TC1 is the consequence of different heat fluxes as shown in Fig. 8 with  
24 a simplified approach. The first maximum temperature, at time 1 s, is reached due to the  
25 heat flux  $F_2$  caused by the forming of the nearest thread. Other contributions are flux  $F_1$   
26 coming from the upper formed thread and flux  $F_3$  which goes to the bottom of the sample  
27 where temperatures are lower. The conjunction of these different fluxes explains the  
28 second maximum 3 s later. Generally, due to the sample's geometry, the heat is  
29 conducted to the bottom of the sample. As a result, the temperature of the oil, which is not  
30 removed from the hole by the tool, increases over a long time, as registered by the  
31 thermocouple TC2 and shown in Fig. 10.  
32  
33

34 The first maximum in temperature, called TC1max on Fig. 9, may be considered as being  
35 a characteristic temperature of the lubrication effect. Results of the temperature  
36 measurements are summed up in Fig. 11. With oil no. 2, which was classified as the  
37 second best oil in efficiency (Fig. 5), has a peak temperature of 111°C. In comparison,  
38 emulsion no. 1, which is an inefficient lubricant if the tapping torque is considered, reaches  
39 a temperature of 153°C. Thus, the temperature is correlated with the efficiency of the  
40  
41  
42  
43  
44  
45  
46  
47  
48  
49  
50  
51  
52  
53  
54  
55  
56  
57  
58  
59  
60  
61  
62  
63  
64  
65

1 lubricant. The temperature of oil no. 9 is higher than the one of oil no. 8 which is higher  
2 than the one of oil no. 2.  
3  
4

5  
6  
7 The site of the lubricant temperatures TC2 shown in Fig. 10 does not correspond to the  
8 workpiece temperature shown in Fig. 9. The temperature of emulsion no. 1 is lower than  
9 those of the three oils, whereas the emulsion leads to more heat generated. This is  
10 explained by the fact that emulsions have a higher specific heat than oils.  
11  
12  
13

14  
15  
16 There is an equilibrium linked to different interactions between temperature, lubricant  
17 reaction and torque. Torque creates a thermal energy increase, the temperature allows  
18 chemical reactions of additives, and the lubricant reaction reduces the torque, as  
19 explained in Fig. 12. These measurements show that efficient lubricants become active at  
20 lower temperatures than poor lubricants.  
21  
22  
23  
24

## 25 26 27 **4. Investigation of tapped samples**

28  
29 The tested oils have an important effect on torque, and particularly, they may change the  
30 *Formation Torque*. This means that oils may change metallurgical aspects in the formed  
31 thread. It has been shown that the additives are involved in the lubrication process. Thus,  
32 the additives must have reacted and the chemical elements which composed them would  
33 be traceable on the thread surface.  
34  
35  
36  
37  
38  
39

### 40 41 42 **4.1. Metallurgical analysis of the formed thread**

43  
44 With form tapping, the thread is obtained by the displacement of the work material. This  
45 plastic flow leads to strain-hardening of the material. The analysis of the photo micrograph  
46 of the sample shows different deformed zones such as the flank and the root of the thread.  
47 Hardness measurements were performed in order to observe the influence of the lubricant  
48 on the strain within the work material. A chemical nickel coating is used in order to  
49 measure the hardness as close as possible to the root. Fig. 13 presents Vickers  
50 microhardness measurements from 15  $\mu\text{m}$  to 250  $\mu\text{m}$  of the root for oil no. 2 and emulsion  
51 no. 1.  
52  
53  
54  
55  
56  
57  
58  
59  
60  
61  
62  
63  
64  
65

1 This data shows that the strain-hardening in the thread is higher when using a poor  
2 lubricant. This point is correlated with the *Mean Torque*, i.e., the higher the torque is during  
3 tapping, the higher is the strain-hardening. All hardness measurements taken on different  
4 samples tapped with the other lubricants confirm this point. Regarding the form of the split  
5 crest in Fig. 14, it appears that lubrication influences the formation process. So the level of  
6 friction between the thread former and the work material is affected by the lubricant and,  
7 as a result, it clearly changes the strain distribution within the deformed material. This  
8 would also mean that the strength of the thread depends on the lubricant used during  
9 tapping.  
10

11 This analysis can be supported by examining the strain-hardening resulting from each lobe  
12 of the entry taper. If the bottom of the blind tapped hole is observed every 72° (i.e., 360°  
13 divided by the 5 lobes of the tool), the thread can be analyzed at different stages of  
14 formation. This method was previously explained [7]. Fig. 15 presents the Vickers  
15 microhardness at 30 μm distance from the root as a function of the number of lobes having  
16 worked. The first 10 lobes are in the entry taper, and each one deforms the work material  
17 to a harder state than the previous one. The 11<sup>th</sup> lobe is the first lobe in the back taper of  
18 the tool, and there is no more strain-hardening. The curves drawn concern emulsion no. 1  
19 and oil no. 2 as in Fig. 13. It appears that for the emulsion the strain-hardening along the  
20 thread formation is much higher than for oil no. 2. This confirms the previous results.  
21  
22  
23  
24  
25  
26  
27  
28  
29  
30  
31  
32  
33  
34  
35  
36  
37  
38  
39  
40  
41  
42  
43  
44  
45  
46  
47  
48  
49  
50  
51  
52  
53  
54  
55  
56  
57  
58  
59  
60  
61  
62  
63  
64  
65

## 4.2. EDS analysis on the thread surfaces

It has been established that the viscosity of the oil does not influence the torque during tapping and as a result additives contained in lubricants may be the main cause affecting the torque. This hypothesis would be confirmed if high pressure additives based on sulphur and chlorine appear at the surface of the threads.

The percentage of sulphur and the appearance of chlorine on the root of the 3 pitches in the middle samples are measured with SEM equipped with EDS. Unfortunately, the SEM used is not calibrated to quantify the percentage of chlorine. The steel used has a higher machinability due to inclusions of manganese sulphide. However, the presence of these sulphides in the work material does not interfere with the measurements on the root of the thread of sulphur coming from the oil. The EDS spectrums show that there is a high peak of sulphur without the appearance of manganese, thus the measurement is not related to manganese sulphide.

Fig. 16 shows the results concerning each lubricant. The percentage of sulphur measured on the root of the sample tapped with emulsions is insignificant compared to the one tapped with oil. Thus, the poor ability of emulsions to lubricate during processing is confirmed. Sulphur is detected by EDS on the thread tapped with oil containing sulphured additives, i.e., oil no. 1 to 3 and oil no. 6 to 9. In the case of thread tapped with oil no. 4, 5 and 7 containing chlorinated additives, the appearance of chlorine is revealed by EDS analysis. Regarding the oils based mainly on sulphured additives, the weight percentage of sulphur on the thread is between 0.7% and 0.8% except for the two less efficient oils. Concerning the oils no. 8 and no. 9, the rate rises to 1.4%. These measurements are reliable, and the presence of sulphur on the thread seems to be in contradiction with the fact that its use leads to the highest torques. Several hypotheses may be proposed. The chemical reaction time for additives with iron could be too long and the tap travels out when the reaction starts. Another hypothesis is that the sulphides, which are produced by the chemical reaction of the additive, do not reduce friction. The last hypothesis is that the lubricant would be degraded by too high temperature. In the case of oil no. 9 it would be confirmed with the increasing torque after  $T_3$  and moreover, on the last formed thread, 7% sulphur is measured. Thus, in the case of oil no. 9, no correlation is noted between the torque, the created heat and the lubricant reaction.

1 Analysis of sulphur percentage on the thread with its formation is conducted on a tapped  
2 sample with oil no. 2. Fig. 17 shows an increasing percentage with the number of lobes  
3 having worked. This is correlated with the strain-hardening previously measured. During  
4 the deformation of the work material, strain energy is converted into heat and it results in a  
5 temperature rise. The strain-hardening during thread formation, resulting from higher strain  
6 energy, shows that the temperature is increasingly high on the lobe in the entry taper. This  
7 corresponds to the increase from the ambient temperature to the maximum TC1  
8 temperature on Fig. 9. The increasing temperature causes a more and more efficient  
9 chemical reaction, implying that the sulphur percentage on the root of the thread grows.

### 19 **4.3. XPS analysis of thread surfaces**

21 It has been shown by EDS that the sulphur percentage on threads tapped with different  
22 oils is not characterizing the lubrication efficiency of the oil. Further understanding can be  
23 obtained by analyzing the sulphured layer on the threads with other devices than EDS.  
24 Thus, the analysis of the threads, tapped with two chosen oils no. 2 and 6, is realized by  
25 means of the X-ray Photoelectron Spectroscopy (XPS), which is a surface analysis  
26 technique. These two oils have quite different additive formulation (cf. §2) and show a  
27 distinct lubrication efficiency in tapping possibly related to various chemical bonds created  
28 during form tapping. This kind of surface analysis should reveal the information about the  
29 sulphur form and bring to light the possible scenario of physico-chemical reactions that  
30 took place.

31 Before introducing them into the analysis vacuum chamber, the threads are cut (dry  
32 machining) and washed ultrasonically in a bath of pure heptane. The oils residues have to  
33 be removed to guarantee the very investigation of the chemical reaction products of  
34 additives with the metallic surface. The zone of analysis is localized at the root of the  
35 totally formed part of thread which is the zone subjected to the heaviest contact with the  
36 tap.

37 The XPS analysis is carried out with a Mg K (1253.4 eV) line excitation source (VG XR2)  
38 and the detection is made by the VG ESCALAB 220i spectrometer. The X-ray power and  
39 analyzer resolution are 180 W and 0.72 eV, respectively. Advantage® software is  
40 employed for the recording and processing of XPS spectra and a Shirley background is  
41 used for their fitting. Constraints such as L/G ratio (60%) and FWHM are applied to border



1 them. The relative intensities of the spin-orbit features for the  $S2p_{3/2}$  and  $S2p_{1/2}$  peaks are  
2 considered during the fitting of the sulphur spectra.  
3

4 Determination of sulphur form (peak position) is vital in this case in comparison to  
5 gathering precise information about the atomic percentages of each chemical element  
6 individually. So, the adventitious carbon and any other surface contaminants were not  
7 removed by argon ion: an ion sputtering may accidentally modify the position of sulphur  
8 peak on XPS spectra.  
9

10 The four common chemical elements discerned on XPS spectra of the tapped threads  
11 surfaces with oils no. 2 and 6 are carbon, oxygen, iron and sulphur. Among them, only  
12 sulphur spectrum is significantly different on the surfaces of the two analyzed specimens  
13 (threads tapped with oil no. 2 and 6). This observation agrees with the assumption put  
14 forward above: various chemical phenomena occurred, in which the atoms of sulphur  
15 contained in the two different blends took part.  
16

17 Electron binding energies in the XPS spectrum were calibrated against the carbon  $C1s$   
18 main peak which is considered granted at 285 eV (bonds C-C, C-H). Two other binding  
19 energies of  $C1s$  at 287 eV and 289 eV observed for both analyzed specimens can be  
20 attributed to different carbon-oxygen bonds (C-O, O-C=O, carbonate). The binding  
21 energies of  $O1s$  indicate the presence of oxides (among others, iron oxides) and confirm  
22 the presence of carbon-oxygen groups on the surfaces. The iron is easily noticeable by  
23 XPS analysis on these two samples. The most intense peaks of iron are assigned to be at  
24 around 709.5 eV-710 eV and 711 eV corresponding to iron oxides of  $Fe^{2+}$  type and/or  
25 sulphides and iron oxides of  $Fe^{3+}$  type respectively. Another one, significantly less intense,  
26 at 707 eV can be attributed to the metallic iron ( $Fe^0$ ). The surface of tapped threads is  
27 widely covered by iron oxides as it was confirmed by the presence of oxides on oxygen  
28 spectra. Fig. 18 shows the XPS spectra of sulphur. An important peak of sulphides at  
29 161.3 eV and another one at 168 eV assigned to sulphates are discerned on the surface of  
30 thread formed with oil no. 6. On the surface of thread formed with oil no. 2, only one peak  
31 close to 168 eV is observed and corresponds to sulphates. Furthermore, there is no other  
32 significant peak which could be attributed to another form of sulphur existing on the  
33 surface of the thread formed with oil no. 2.  
34

35 Surprisingly, even if metallic sulphides are well known for their anti-seizure properties, it  
36 looks like that in fact they are not the best-adapted lubricating reaction product of sulphur  
37  
38  
39  
40  
41  
42  
43  
44  
45  
46  
47  
48  
49  
50  
51  
52  
53  
54  
55  
56  
57  
58  
59  
60  
61  
62  
63  
64  
65

1 for form tapping (oil no. 6 is less efficient than oil no. 2). At first sight, it is possible that any  
2 other element contained in oil no. 6 could somehow affect and decrease the overall  
3 lubrication efficiency of this blend. Nevertheless, due to the complexity of its formulation, it  
4 is hardly possible to determine the exact chemical reactions involving all the components.  
5 This hypothesis however seems to be less probable regarding the similar quantity of  
6 sulphur detected on the surface of the thread realized with oil no. 6 in comparison to the  
7 specimen obtained with oil no. 2; the reactivity of sulphur in the case of oil no. 6 is rather  
8 comparable to the one of oil no. 2.  
9

10 On the other hand, the presence of sulphates on the surface is often attributed to oxidation  
11 of sulphides or other sulphur species [14]. This explanation is probably true for the  
12 specimen tapped with oil no. 6. In the case of specimen tapped with oil no. 2, the peak of  
13 sulphates is too intense to be only due to oxidation; in the meantime, any other residual  
14 sulphur species which could be the source of oxidation is not observed. Additionally, the  
15 analysis of Na1s peak (1071 eV) shows the presence of sodium sulphate/sulphonate on  
16 the surface that obviously can be assigned to the oxygenated form of sulphur as shown on  
17 the sulphur spectra of specimen tapped with oil no. 2.  
18

19 Form tapping is a severe machining operation but the temperature and the velocity of the  
20 sliding matter still remain lower than in the case of any cutting operation. Indeed, it can be  
21 supposed that in the case of the sulphur additive enclosed in blend no. 6, its atoms are  
22 very mobile and can be easily liberated during form tapping to promote the formation of  
23 sulphides (for example polysulfure). Contrary to the previous case, the sulphur additive  
24 added to oil no. 2 contains sulphur, which in the range of thermal and mechanical  
25 solicitations in form tapping, does not decompose completely and participates to the  
26 formation of chemically adsorbed layer of sulphates/sulphonates. In form tapping, the layer  
27 formed by oil no. 2 has a better anti-friction behaviour expressed by a lower tapping torque  
28 than the layer of sulphides, which is essentially characterized by its capacity of preventing  
29 the welding wear.  
30

## 31 **5. Conclusions**

32 The present study evaluates the ability of 9 oils and 2 water-based emulsions to reduce  
33 friction in form tapping. From this study, important differences are shown to exist between  
34  
35  
36  
37  
38  
39  
40  
41  
42  
43  
44  
45  
46  
47  
48  
49  
50  
51  
52  
53  
54  
55  
56  
57  
58  
59  
60  
61  
62  
63  
64  
65

1 these lubricants, and consequently the choice of suitable oils for form tapping is necessary  
2 to obtain success with this process.  
3

4 An efficient oil may reduce not only the friction on the back taper of the thread former, but  
5 also the friction force on the entry taper. As a result, the metallurgical aspects of the  
6 formed thread are affected, as the profile of the split crest and the work hardening during  
7 formation. The efficiency of oil depends mostly on its additives and less on its viscosity,  
8 and lubrication mechanism in form tapping of high strength steels is mainly achieved by  
9 chemical way. Surface analysis on the threads confirms the reaction of the fluid additives,  
10 based on sulphur, with the work material. XPS analysis points out the formation of different  
11 sulphured species on the surfaces of the threads formed with two distinct oils; the  
12 efficiency of these two lubricants in form tapping seems to be essentially affected by the  
13 chemical reactions involving sulphur and probably much less by its quantity (the sulphur  
14 percentage detected by EDS on the surfaces formed with both tested oils is quite similar).  
15 In addition, the surfaces of the threads formed with the oils that contributed to the poorest  
16 lubrication in form tapping were twice and more abounding in sulphur than those analyzed  
17 by XPS. Thus, the key to performance of a given lubricant in form tapping is surely  
18 determined by the molecular structure of the sulphur additive and its thermal behaviour.  
19  
20  
21  
22  
23  
24  
25  
26  
27  
28  
29  
30  
31

32 Furthermore, it would be interesting to qualify other lubrication technologies, such as  
33 Minimum Quantity of Lubricant (MQL) or solid lubricant coatings, for form tapping  
34 applications in hardened steel.  
35  
36  
37  
38  
39  
40  
41  
42  
43  
44  
45  
46  
47  
48  
49  
50  
51  
52  
53  
54  
55  
56  
57  
58  
59  
60  
61  
62  
63  
64  
65

1  
2  
3  
4  
5  
6  
7  
8  
9  
10  
11  
12  
13  
14  
15  
16  
17  
18  
19  
20  
21  
22  
23  
24  
25  
26  
27  
28  
29  
30  
31  
32  
33  
34  
35  
36  
37  
38  
39  
40  
41  
42  
43  
44  
45  
46  
47  
48  
49  
50  
51  
52  
53  
54  
55  
56  
57  
58  
59  
60  
61  
62  
63  
64  
65

## **6. Acknowledgments**

The authors gratefully acknowledge the Walter Prototyp and PSA Peugeot Citroën companies for their support to this research. They would like also to acknowledge Thierry Le MOGNE and Jean-Michel MARTIN for XPS analyses.

## References

- [1] Agapiou JS. Evaluation of the effect of high speed machining on tapping. Journal of Manufacturing Science & Engineering Technology ASME 1994;116:457-462.
- [2] Zhitnitskii SI, Andreichikov OS. Rolling tool for rolling internal thread. Machine & Tooling 1965;36(10):33-36.
- [3] Urlapov GP. Fluteless taps. Machine & Tooling 1969;15(10):46-48.
- [4] Ivanov V, Kirov V. Rolling of internal threads: Part 1. Journal of Materials Processing Technology 1996;72:214-220.
- [5] Chowdhary S, Burak Ozdoganlar O, Kapoor SG, DeVor RE. Modeling and analysis of internal thread rolling. Transactions of the NAMRI of SME 2002;329-336.
- [6] Chandra R, Das SC. Forming taps and their influence on production. Journal of Indian Engineering 1975;55:244-249.
- [7] Fromentin G, Poulachon G, Moisan A. Metallurgical Aspects in Cold Forming Tapping. Proceedings of the 18th International Conference on Manufacturing Research, 10-12 September 2002. Leeds Metropolitan University, England. Editor by K. Cheng and D. Webb, ISBN 1860583784, 373-377.
- [8] Fromentin G, Etude mécanique et technologique du taraudage par déformation : application aux aciers prétraités (in french), PhD defended 22th September 2004, ENSAM Cluny, France.
- [9] Henderer WE, BF von Turkovich. Theory of the cold forming tap. Annals of the CIRP 1974;23:51-52.
- [10] NordTest MECH 039. Tapping torque test for cutting fluid evaluation. NordTest Method. 1998.
- [11] ASTM D5619-00. Standard test method for comparing metal removal fluids using the tapping torque test machine, American Society for Testing and Materials. 2000.
- [12] Hong H. Machinability of steels and titanium alloys under lubrication. Wear 1993;162-164:34-39.
- [13] Haigang C. The tribological behaviours of various metallic cations in tapping of titanium alloy. Wear 2001;247:120-123.

1  
2  
3  
4  
5  
6  
7  
8  
9  
10  
11  
12  
13  
14  
15  
16  
17  
18  
19  
20  
21  
22  
23  
24  
25  
26  
27  
28  
29  
30  
31  
32  
33  
34  
35  
36  
37  
38  
39  
40  
41  
42  
43  
44  
45  
46  
47  
48  
49  
50  
51  
52  
53  
54  
55  
56  
57  
58  
59  
60  
61  
62  
63  
64  
65

[14] Pratt A.R., Muir I.J., Nesbitt H.W., X-ray photoelectron and Auger electron spectroscopic studies of pyrrhotite and mechanism of air oxidation, *Geochimica et Cosmochimica Acta* 1994; 58(2):827-841.

ig. captions

Fig. 1. EDS Spectrum of oil no. 3.

Fig. 2. Evolution of the torque during a form tapping operation.

Fig. 3. Different positions of the tap during processing.

Fig. 4. Torque curves for different lubricants.

Fig. 5. Synthesis of torque results for all lubricants

Fig. 6. Mean torque versus oil viscosity.

Fig. 7. Effect of the viscosity of oil no. 2 on torque.

Fig. 8. Thermocouple localisations and heat fluxes designation.

Fig. 9. Temperatures measured at 1mm from the thread root by TC1.

Fig. 10. Temperature measured in the fluid by TC2.

Fig. 11. Summary of the temperatures measured.

Fig. 12. Mechanical, thermal, and chemical interactions.

Fig. 13. Microhardness at the root of the thread.

Fig. 14. Photo micrographs of samples made with emulsion no. 1 and oil no. 2.

Fig. 15. Strain hardening along the thread formation.

Fig. 16. Sulphur weight percentage on tapped samples.

Fig. 17. Sulphur weight percentage evolution during the thread formation with oil no. 2.

Fig. 18. Chemical shifts of sulphur peak on the surfaces of formed threads with oils no. 2 and 6 (XPS analysis)





## Table captions

Table 1. Values of the kinetic viscosities and designations of the chemical elements.

Table 2. Oil characteristics for testing the viscosity effect.

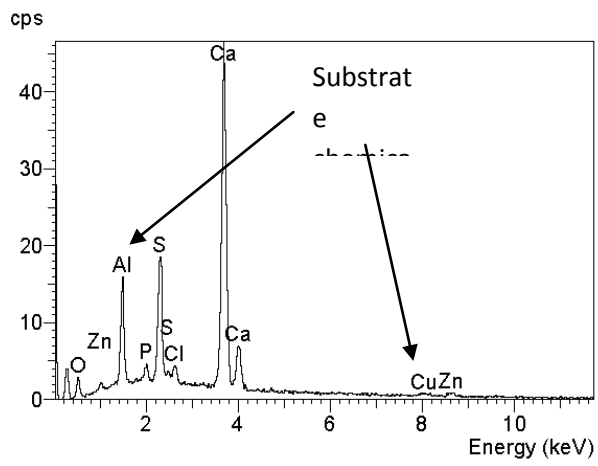

Fig.1. EDS Spectrum of oil no. 3.

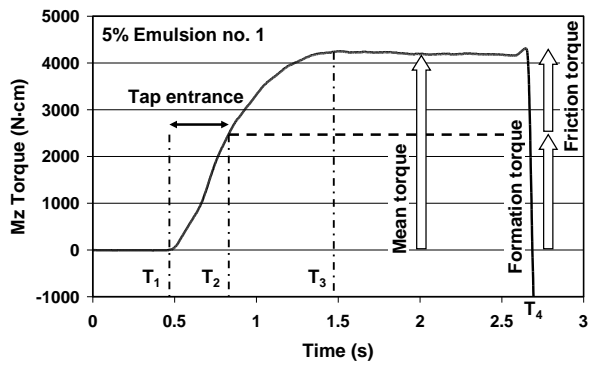

Fig.2. Evolution of the torque during a form tapping operation.

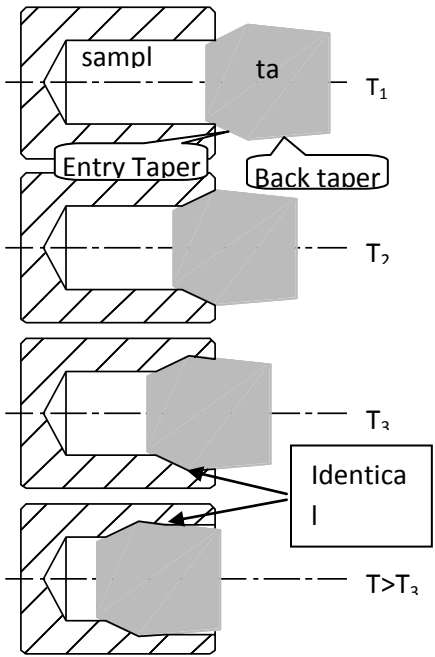

Fig.3. Different positions of the tap during processing.

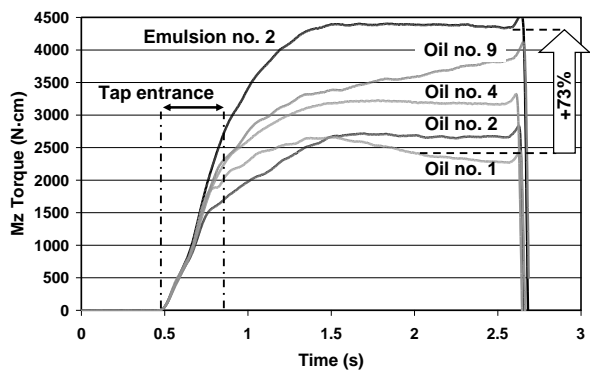

Fig.4. Torque curves for different lubricants.

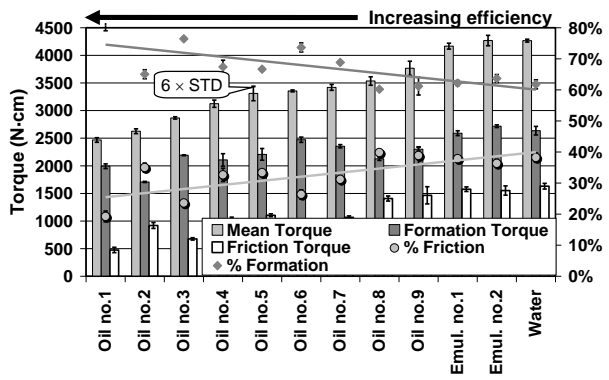

Fig.5. Summary of torque results for all lubricants.

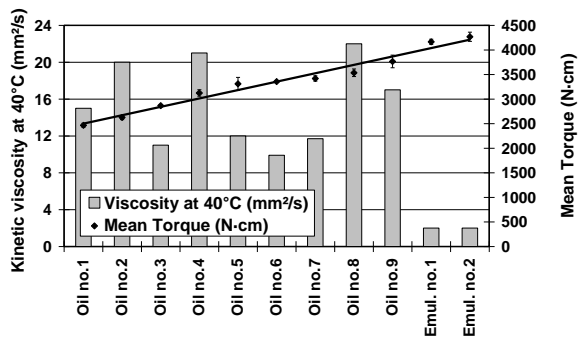

Fig.6. Mean torque versus oil viscosity.

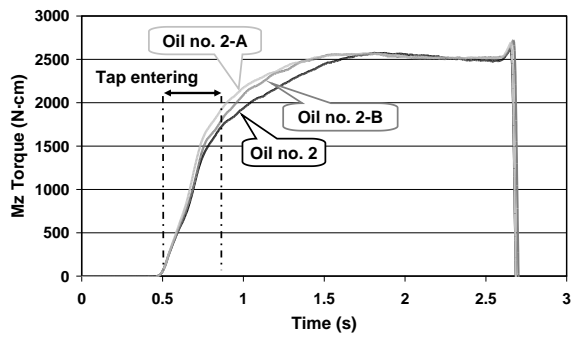

Fig.7. Effect of the viscosity of oil no. 2 on torque.



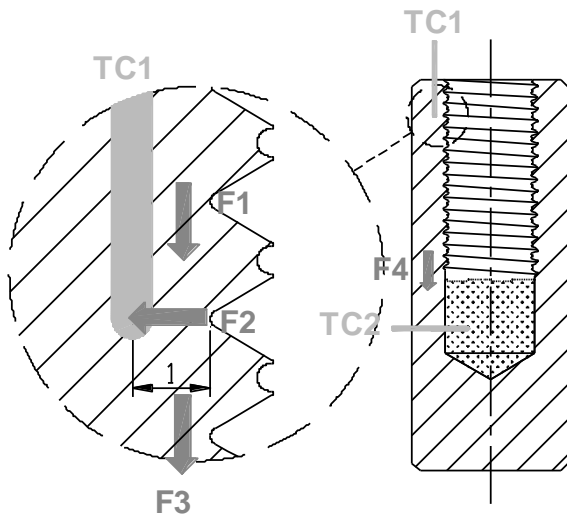

Fig.8. Thermocouple localizations and heat fluxes designation.

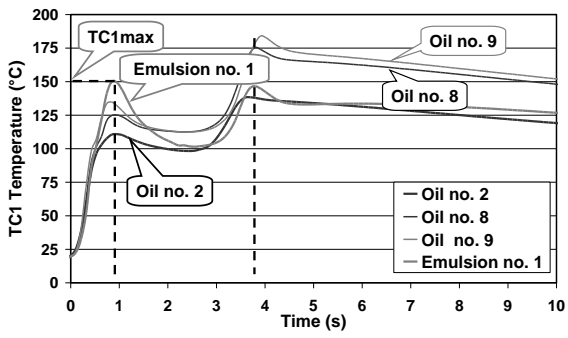

Fig.9. Temperatures measured at 1mm from the thread root by TC1.

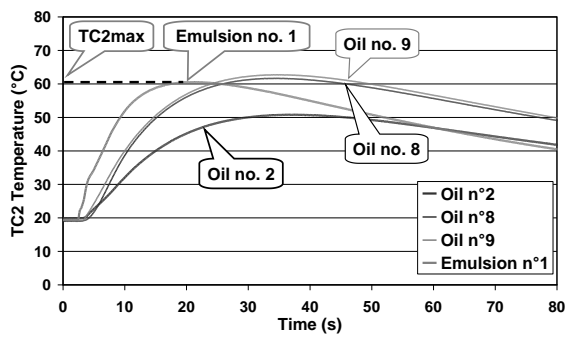

Fig.10. Temperature measured in the fluid by TC2.

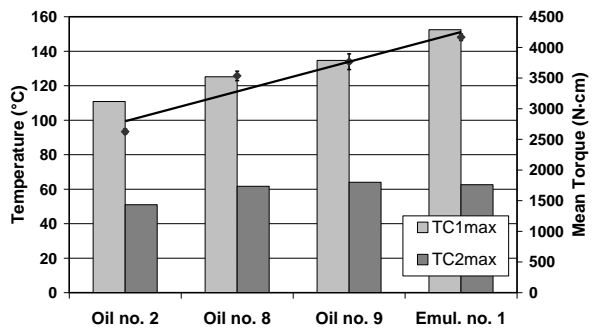

Fig.11. Summary of the temperatures measured.

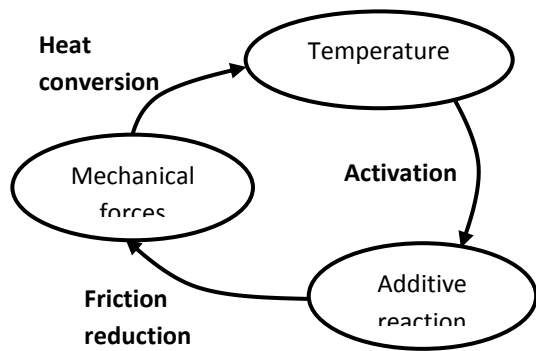

Fig.12. Mechanical, thermal, and chemical interactions.

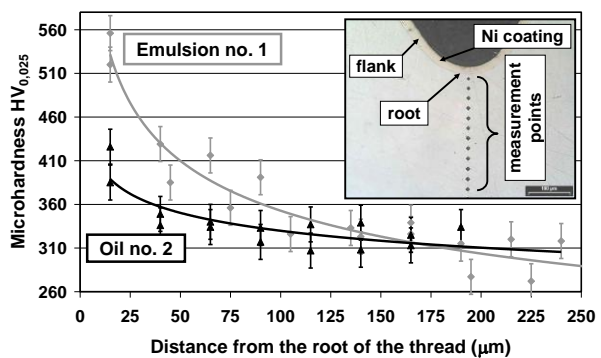

Fig.13. Microhardness at the root of the thread.

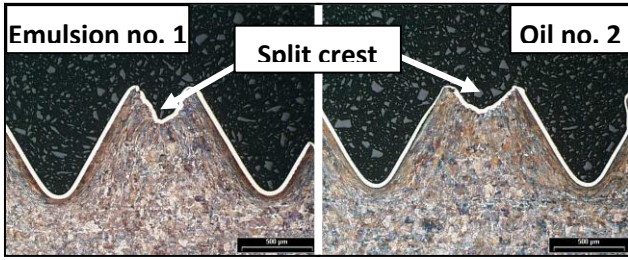

Fig.14. Photo micrographs of samples made with emulsion no. 1 and oil no. 2.

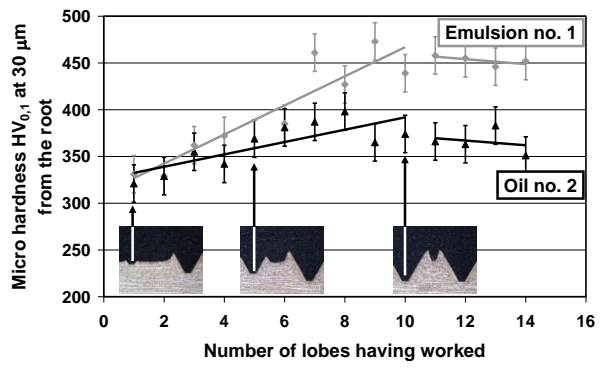

Fig.15. Strain-hardening along the thread formation.



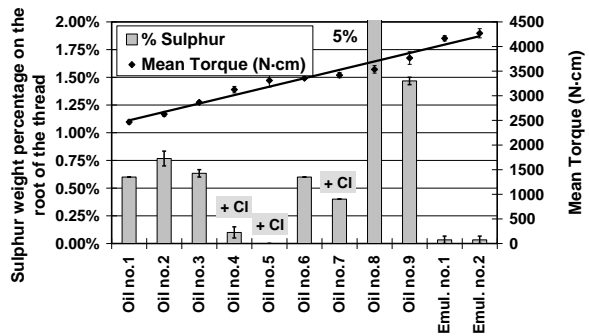

Fig.16. Sulphur weight percentage on tapped samples.

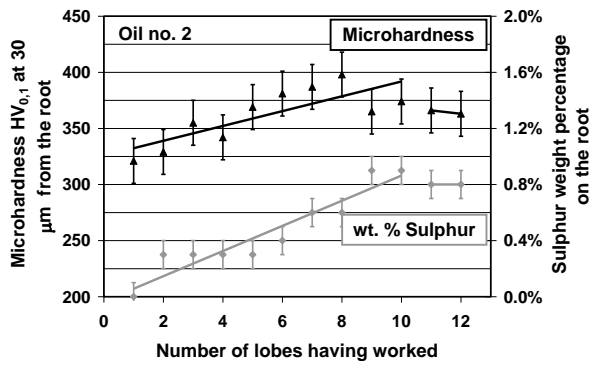

Fig.17. Sulphur weight percentage evolution during the thread formation with oil no. 2.

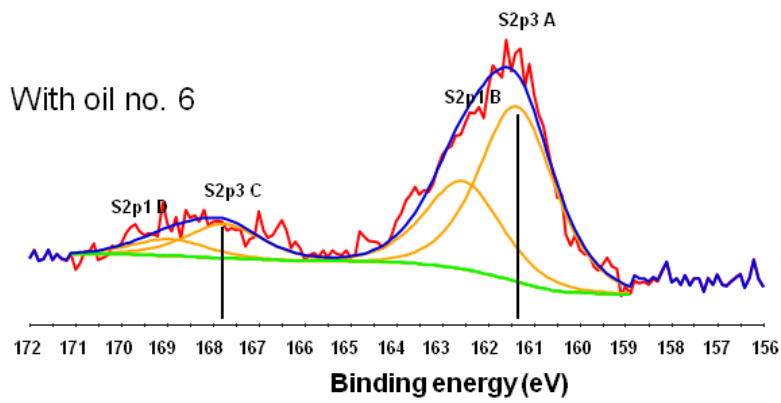
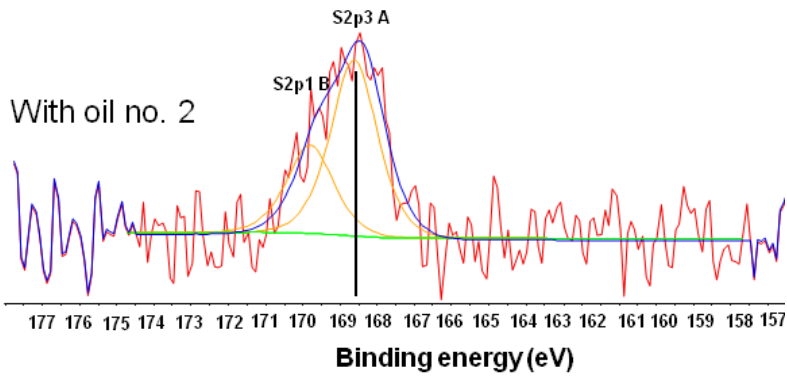

Fig.18. Chemical shifts of sulphur peak on the surfaces of formed threads with oils no. 2 and 6 (XPS analysis)



	<b>Kinetic viscosity at 40°C (mm<sup>2</sup>/s)</b>	<b>Chemical elements of additives</b>	<b>Manufac turer</b>
<b>Oil no. 1</b>	15	S+Ca	M1
<b>Oil no. 2</b>	20	S+Na	M2
<b>Oil no. 3</b>	11	S+Ca+P+Zn	M2
<b>Oil no. 4</b>	21	Cl	M3
<b>Oil no. 5</b>	12	Cl	M2
<b>Oil no. 6</b>	9,9	S+Ca+P+Zn	M4
<b>Oil no. 7</b>	11,7	Cl+S+P+Na	M4
<b>Oil no. 8</b>	22	S	M4
<b>Oil no. 9</b>	17	S+P+Ca	M5
<b>5% Emul. no. 1</b>	2	S+P+Na+K	M6
<b>20% Emul. no. 2</b>	2	S+Na+P+K	M2

Table 1. Values of the kinetic viscosities and designations of the chemical elements.

	<b>Kinetic viscosity at 40°C (mm<sup>2</sup>/s)</b>	<b>Chemical elements of additives</b>	<b>Manufac turer</b>
<b>Oil no. 2</b>	20	S + Na	M2
<b>Oil no. 2- A</b>	11.6	S + Na	M2
<b>Oil no. 2- B</b>	6.3	S + Na	M2

Table 2. Oil characteristics for testing the viscosity effect.