



**HAL**  
open science

## Power Smoothing Control of a Grid-Connected Marine Current Turbine System Using Supercapacitors

Zhibin Zhou, Franck Sculler, Jean Frédéric Charpentier, Mohamed Benbouzid

► **To cite this version:**

Zhibin Zhou, Franck Sculler, Jean Frédéric Charpentier, Mohamed Benbouzid. Power Smoothing Control of a Grid-Connected Marine Current Turbine System Using Supercapacitors. EMR 2013, Oct 2013, Brest, France. pp.1-7. hal-00874492

**HAL Id: hal-00874492**

**<https://hal.science/hal-00874492>**

Submitted on 18 Oct 2013

**HAL** is a multi-disciplinary open access archive for the deposit and dissemination of scientific research documents, whether they are published or not. The documents may come from teaching and research institutions in France or abroad, or from public or private research centers.

L'archive ouverte pluridisciplinaire **HAL**, est destinée au dépôt et à la diffusion de documents scientifiques de niveau recherche, publiés ou non, émanant des établissements d'enseignement et de recherche français ou étrangers, des laboratoires publics ou privés.

# LISSAGE SUPERCAPACITIF DE LA PUISSANCE PRODUITE PAR UNE HYDROLIENNE CONNECTEE AU RESEAU

## *Power Smoothing Control of a Grid-Connected Marine Current Turbine System Using Supercapacitors*

Zhibin Zhou<sup>1,2</sup>, Franck Sculler<sup>1</sup>, Jean Frédéric Charpentier<sup>1</sup> and Mohamed Benbouzid<sup>2</sup>

<sup>1</sup>Ecole Navale, EA 3634, IRENav

<sup>2</sup>Université de Brest, EA 4325 LBMS

*Résumé*—Les variations de la vitesse des courants marins induisent généralement de grandes fluctuations de la puissance produite par une hydrolienne. La houle est considérée comme principale source de variation à très court terme des vitesses de courants. Une stratégie MPPT conventionnelle nécessiterait dans ces conditions d'accélérer ou de décélérer fréquemment la turbine entraînant ainsi de fortes fluctuations de la puissance générée. Cet article se propose alors d'étudier le lissage de la puissance produite par une hydrolienne équipée d'une génératrice synchrone à aimants permanents à laquelle sera associé un banc de supercondensateurs. Le système sera commandé au moyen de stratégies de contrôle appropriées. Pour ce faire un algorithme de MPPT modifié associé à une stratégie de filtrage est proposé. Il utilisera plus particulièrement l'inertie du système pour atténuer les fluctuations de la puissance. Le système de stockage supercapacitif est ensuite utilisé pour lisser les fluctuations résiduelles. Des simulations sur une hydrolienne à entraînement direct de 1.5 MW connectée au réseau montrent que l'association de la stratégie de contrôle proposée à un stockage supercapacitif permet d'injecter une puissance relativement lisse au réseau en présence de perturbations liées à la houle.

*Mots-clés*—Hydrolienne, houle, génératrice synchrone à aimants permanents, lissage de la puissance, supercondensateur.

*ABSTRACT*—Variations of marine current speed can lead to strong fluctuations in the power extracted by a marine current turbine (MCT). During short-time period, swell effect is the main cause for the current speed variations. Conventional tip speed ratio Maximum Power Point Tracking (MPPT) algorithm will require the MCT to accelerate or to decelerate frequently under swell effect, which can cause severe fluctuations in the generator power. This paper focuses on power smoothing control of a PMSG-Based MCT system. A modified MPPT algorithm with filter strategy is proposed in generator-side control to use the system inertia for smoothing the fluctuation of generator power. When the current speed is over rated value, the power limitation control will be applied. In the second step, Supercapacitor (SC) Energy Storage System (ESS) is added to compensate the residual power fluctuations. Simulations of a 1.5 MW direct-driven grid-connected MCT system are carried out. The results demonstrate that the association of the generator-side filter strategy with the SC ESS system achieves a smoothed power injected to the grid in case of swell disturbances.

*Key words*—Marine current turbine, swell effect, PMSG, power smoothing control, supercapacitor.

## I. INTRODUCTION

During short-time period, swell waves are the main cause for variations in the marine current speed and can lead to marine current speed fluctuations on a period about 10 to 20 s. These current speed variations could cause high fluctuations in the power harnessed by a marine current turbine (MCT) system if conventional tip-speed ratio Maximum power point tracking (MPPT) is used [1-2]. Therefore, the swell effects and appropriate power smoothing control strategy should be studied for MCT applications.

Due to accessibility difficulty for underwater equipment, compact structure and low maintenance requirements are expected for MCTs. Recent MCTs such as the EDF-OpenHydro and the Voith Hydro turbine system adopt non-pitchable blades to simplify the MCT and use PMSG to realize direct-drive system. For fixed blade turbines, the power limitation which is usually done by pitch angle control should be done with generator-side control strategy. This work focuses on two main points: the first one is to investigate a specific control strategy which reduces the swell-induced power fluctuations; the second point is to integrate energy storage system (ESS) for transferring stable and smoothed power to the grid. Figure 1 shows the general scheme for the PMSG-based grid-connected MCT system with ESS.

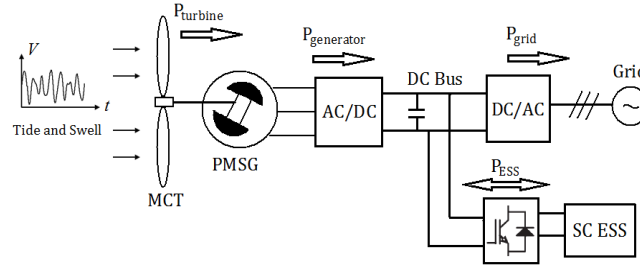

Figure 1. General scheme for a direct-drive MCT system with ESS.

The paper will be divided into three main sections. In Section 2, the swell modeling and the power fluctuation phenomenon will be presented. In Section 3, the turbine power characteristics and the generator-side power smoothing control strategy with an original filter algorithm will be presented. In Section 4, the grid-side control and the supercapacitor (SC) ESS control will be described and the simulation results will be discussed. The conclusion will be given in Section 5.

## II. SWELL EFFECT AND POWER FLUCTUATION

In this paper, the first order Stokes model is used to calculate horizontal speed oscillations induced by swell waves. The total marine current speed is then calculated by the combination of predicted tidal speed and swell effect as follow [1-2].

$$V(t) = V_{\text{tide}} + \sum_i \frac{2\pi a_i}{T_i} \frac{\cosh\left(2\pi \frac{z+d}{L_i}\right)}{\sinh\left(2\pi \frac{d}{L_i}\right)} \cos 2\pi \left( \frac{t}{T_i} - \frac{x}{L_i} + \varphi_i \right) \quad (1)$$

It contains two parts: the first item  $V_{\text{tide}}$  represents the predicted tidal speed, which can be regarded as a constant during a period of a few minutes; the second term represents the current speed oscillation caused by the swell. Figure 2 shows the main characteristic of one simple swell ( $x$  and  $z$  represent the horizontal and vertical point for the calculation). More than one frequency component should be considered to model a realistic swell effect. That explains the superposition calculation in the second term of (1). Each swell frequency component is calculated based on the swell spectrum and ocean wave theories;  $\varphi_i$  represents the initial phase angle of each frequency component which is given randomly. Figure 3 shows the swell spectrum (JONSWAP spectrum) used in this paper. The effects of the cross interaction between current and swell is not taken into account in this simple model.

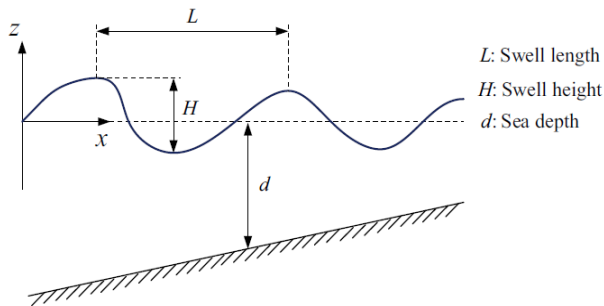

Figure 2. Characteristic of one simple swell wave.

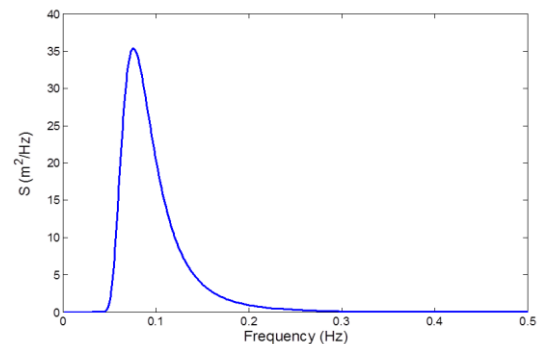

Figure 3. Swell spectrum based on JONSWAP spectrum.

Swells are created from wind waves and travel through long-distant propagation after their generating area. The process of dispersion (low frequency wave components propagate faster than high frequency wave components) takes place during the swell propagation. Thus, the swell observed at a fixed station has a spectrum restricted to a narrow frequency range. In this paper, the JONSWAP spectrum is chosen as the swell spectrum due to its sharp peak characteristic. The JONSWAP spectrum can be written as follow.

$$S(f) = \beta_j \frac{H_s^2}{T_p^4} \frac{1}{f^5} \exp\left(-\frac{4}{5} \frac{1}{T_p^4} \frac{1}{f^5}\right) \gamma^\gamma \quad (2)$$

Where,  $\gamma = \exp\left[-\frac{(T_p f - 1)^2}{2\sigma^2}\right]$  with  $\sigma = \begin{cases} 0.07, & f \leq 1/T_p \\ 0.09, & f \geq 1/T_p \end{cases}$

The parameter  $\gamma$  is called peak enhancement factor which controls the sharpness of the spectral peak.  $\gamma = 3.3$  is the mean value determined for the North Sea. Larger value can be chosen to reflect the sharp peak characteristic of swell waves. The swell spectrum for engineering applications can be approximated by (2) with the peak enhancement factor being chosen between  $\gamma = 3-10$ , depending on the distance that the swell has traveled [3]. In this paper, the peak enhancement factor is chosen as  $\gamma = 7$ , and the sea state of  $H_s = 3$  m,  $T_p = 13.2$  s is considered. This corresponds to typical sea state in the winter for the western coast of France [4]. The amplitude of each frequency components can be calculated by  $a_i = \sqrt{2S(f_i) f_i}$ . As shown in Fig. 3, the peak frequency in the spectrum is about 0.08 Hz. It corresponds to the peak period  $T_p = 13.2$  s. The narrow frequency range and sharp spectral peak illustrates the swell characteristics.

It should be noticed from (1) that the swell effect on marine current speed also depends on the sea depth and the vertical distance between the calculation point and the sea surface. It means that the sea depth and the installation depth of the turbine must be considered to calculate the swell effect on a given MCT system.

In this paper, the turbine size and location parameters are chosen to be in a configuration near of the EDF-OpenHydro project near the coast of Paimpol in France (Paimpol Bréhat experimental site). The turbine radius is 8 m and the system is supposed to be located at a sea depth of 35 m as shown in Fig. 4. The equivalent marine current speed for this turbine can be calculated at a depth of 22 m below the sea surface.

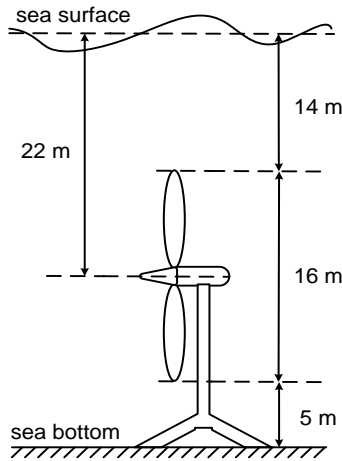

Figure 4. MCT size and location.

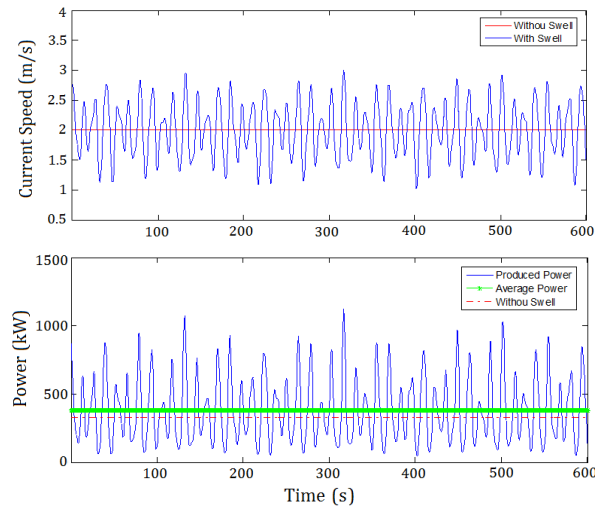

Figure 5. Marine current speed and MCT power.

Figure 5 shows the simulation waveform of total marine current speed and the estimated produced power of the MCT under the swell effect (the tidal speed is assumed as 2m/s in the simulation). It can be seen that the swell effect can induce large oscillations in the marine current speed for the given depth; and these marine current speed oscillations can cause very high fluctuations in the power harnessed by the MCT. One of the challenges of connecting the marine current generation system to the power grid is to obtain a stable and smoothed power even under swell disturbances.

### III. GENERATOR-SIDE POWER SMOOTHING CONTROL

#### III.1 MCT Power Characteristics

For MCTs, the power extracting principles are similar to wind turbines. The power harnessed by a horizontal-axis MCT can be calculated by the following equation.

$$P = \frac{1}{2} \rho C_p \pi R^2 V^3 \quad (3)$$

In (3), the sea water density  $\rho$  and the turbine radius  $R$  are considered as constants;  $V$  is the marine current speed which is considered to be homogeneous in the turbine disk for each given time;  $C_p$  is the turbine power coefficient which depends on the turbine blade structure and its hydrodynamics. For typical MCTs, the optimal  $C_p$  value for normal operation is estimated to be in the range of 0.35-0.5 [5]. For a given turbine and based on the experimental results, the  $C_p$  curve can be approximated as a function of the tip speed ratio ( $\lambda = \omega_m R / V$ ) and the pitch angle. In this paper the considered system is a fixed pitch MCT, so  $C_p$  depends only of  $\lambda$  at first order.

Figure 6 shows the  $C_p$  curve used in this paper. The maximum  $C_p$  value is 0.45 which corresponds to a tip speed ratio of 6.3. This value is considered as the optimal tip speed ratio ( $\lambda_{opt}$ ) for realizing maximum power point tracking (MPPT) under rated marine current speeds.

In this paper, a 1.5 MW direct-driven turbine is studied. The maximum turbine speed to follow MPPT is 25 rpm (2.62 rad/s) for a marine current of 3.2 m/s. When the marine current exceeds 3.2 m/s, the extracted power will be limited to 1.5 MW by power limitation strategies with flux-weakening control [6]. The MCT extractable power under different marine current speeds is calculated by (3) and illustrated by Fig. 7.

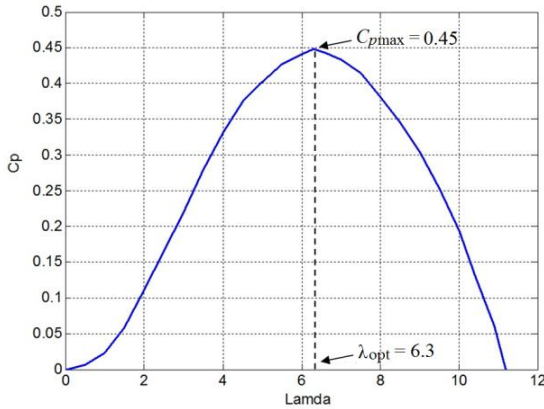

Figure 6.  $C_p$  curve of the MCT.

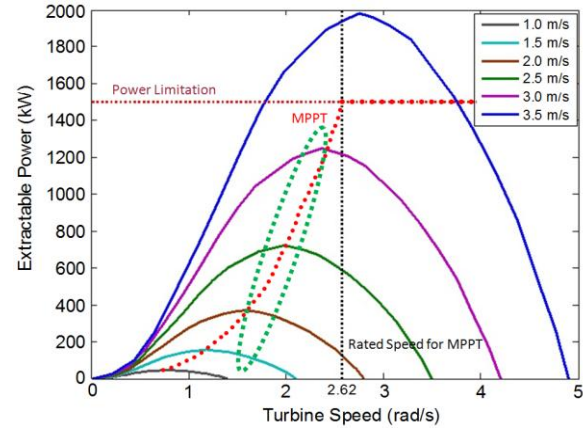

Figure 7. The MCT power characteristics.

### III.2 Generator-side Power Smoothing Control

The PMSG model in the  $d$ - $q$  frame can be described by the following equations ( $L_d = L_q$  in this paper which corresponds to a non-salient machine).

$$\begin{cases} v_d = R_s i_d + L_d \frac{di_d}{dt} - \omega_e L_q i_q \\ v_q = R_s i_q + L_q \frac{di_q}{dt} + \omega_e L_d i_d + \omega_e \Psi_m \\ T_e = \frac{3}{2} n_p \Psi_m i_q \\ J \frac{d\omega_m}{dt} = T_m - T_e - f_B \omega_m \end{cases} \quad (4)$$

In (4),  $v_d$ ,  $v_q$  and  $i_d$ ,  $i_q$  are stator voltages and currents in the  $d$ - $q$  frame respectively;  $R_s$  is the stator resistance;  $L_d$ ,  $L_q$  are inductances in the  $d$ - $q$  frame;  $\omega_e$ ,  $\omega_m$  are machine electrical and mechanical speed;  $T_e$ ,  $T_m$  are respectively the machine electro-magnetic torque and the turbine mechanical torque;  $n_p$  is the machine pole pair number;  $\Psi_m$  is the flux created by the rotor permanent magnets;  $J$  is the total system inertia and  $f_B$  is the friction coefficient associated to the mechanical drive train.

MPPT strategy consists in controlling the rotor speed to keep the turbine tip speed ratio  $\lambda$  at its optimal value, thus keeping the turbine power coefficient  $C_p$  at the maximum value. Supposing that the  $C_p$  curve is known and the marine current speed  $V$  can be obtained by flow velocity measurements, the turbine speed reference calculated by the conventional speed-based MPPT can be expressed as  $\lambda_{opt} V / R$ . In this paper, a low pass filter is added to modify the rotor speed reference calculated by the conventional MPPT algorithm in case of swell effect. The proposed strategy generates the speed reference as

$$\omega_{m\_ref} = \frac{1}{Ts + 1} \cdot \frac{\lambda_{opt} V}{R} \quad (5)$$

where  $T$  is the filter time constant and plays a significant role in reducing the generator power fluctuation caused by swell disturbances. Setting  $T$  to zero leads (5) to the conventional MPPT algorithm (the turbine speed reference follows the marine current fluctuation).

With the conventional tip-top ratio speed reference MPPT, the generator power will fluctuate more severely than the turbine power under swell effect. This can be explained as follow: when we neglect the friction losses in the torque equation in (4), we can get

$$P_{turbine} - P_{generator} = \omega_m T_m - \omega_m T_e = \omega_m J \frac{d\omega_m}{dt} \quad (6)$$

From (6), it can be seen the power difference turbine and generator  $\Delta P = \omega_m J \cdot d\omega_m / dt$  mainly depends on the system inertia  $J$  and the rotor speed change rate  $d\omega_m / dt$  when the system has a large inertia and low operational speed. When the marine current speed changes rapidly under swell effect, the turbine rotor speed will have a synchronous change rate by the conventional MPPT control;  $d\omega_m / dt$  is then not negligible. Considering a 1.5 MW MCT system with large total system inertia, the  $\Delta P$  could be very large.

Figure 8 show the MCT power and generator power profiles using conventional tip-top ratio speed reference MPPT and the proposed MPPT with optimized filter time constant ( $T = 7s$ ). More detailed analysis can be found in [7]

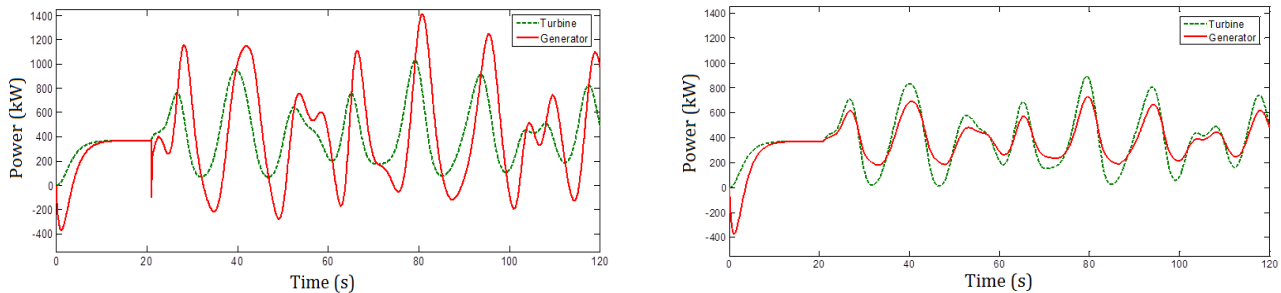

Figure 8. Turbine and generator power responses with conventional MPPT (left) and proposed MPPT (right).

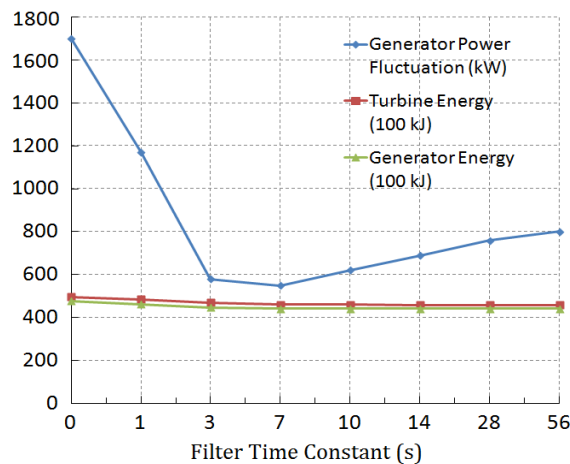

Figure 9. System performances with different filter time constants.

Figure 9 illustrates the system performances with different filter time constants. In this figure, “Generator Power Fluctuation” is calculated by the difference between the maximum and the minimum values of the generator power under swell effect. The energies produced by the turbine and the generator are calculated by integrating the turbine and the generator power respectively.

## IV. GRID-SIDE CONTROL AND SUPERCAPACITOR FOR GRID POWER SMOOTHING

The main function of the grid-side converter is to keep the DC bus voltage stable and to regulate the active and reactive power injected to the grid. Figure 10 shows the grid-side converter control scheme. In this scheme, the  $d$ -axis is oriented to the grid voltage vector, and the grid active power is controlled by the  $d$ -axis current. The  $q$ -axis current reference is set to zero when there is no grid reactive power requirement. The outside DC bus voltage loop is to keep the DC bus voltage at a given value and to produce the current reference for  $d$ -axis.

Figure 11 shows the structure of the supercapacitor (SC) and the relationship between the SC voltage and the SC state of charge (SoC). The SC is modeled by a large capacitor  $C_{sc}$  in series with a small resistance  $R_{sc}$ ;  $L_{sc}$  is the buffer inductor;  $D_1$  and  $D_2$  are the duty ratios for the two power switches of the bi-directional DC/DC converter. The SC aims to compensate the power difference between the generator power and the grid target power.

The SC ESS is controlled by the required SoC according to the charge/discharge demand: when  $I_{grid} > I_{target}$ , the duty ratio will rise to increase the SC voltage and make the SC absorb the power from the DC bus; when  $I_{grid} < I_{target}$ , the SC voltage will decrease to make SC release the stored power.  $I_{target}$  is the current reference representing the smoothed DC current which is expected to be transmitted to the grid-side converter. This grid target reference can be calculated from the predicted tidal current speed when there is no swell; and from filtering the generator power in case of swell disturbance.

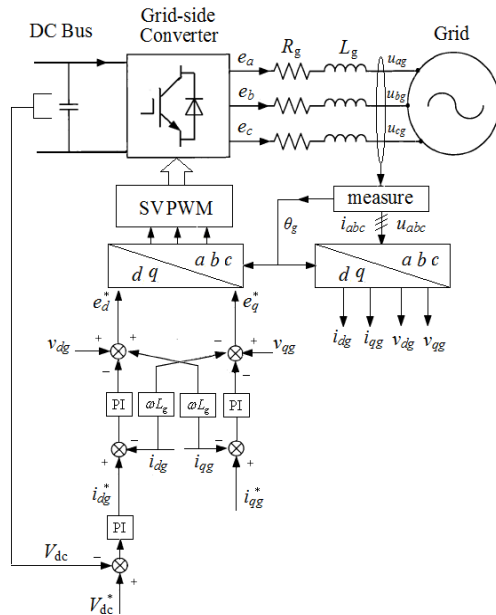

Figure 10. Control scheme of the grid-side converter.

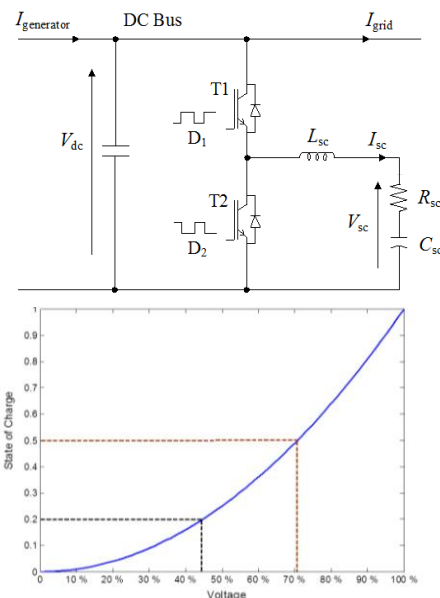

Figure 11. SC model and the state of charge.

Figures 12 and 13 show the grid phase voltage and current simulation waveforms with and without SC ESS. The grid voltage magnitude is assumed to be constant; thereby the variations of grid current magnitude reflect directly the fluctuations of the grid-injected power. Comparison between Fig. 12 and 13 illustrates the SC ability to eliminate power fluctuations: the power transferred into the grid is significantly smoothed.

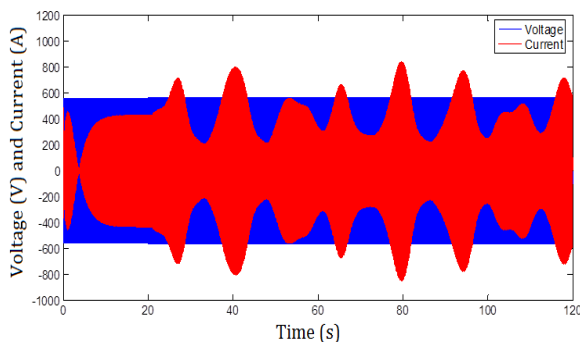

Figure 11. Grid phase voltage and current (without SC).

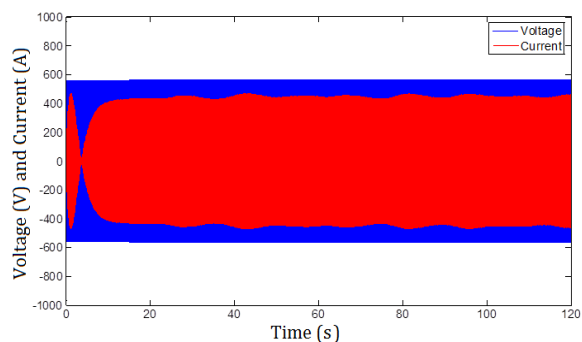

Figure 12. Grid phase voltage and current (with SC).

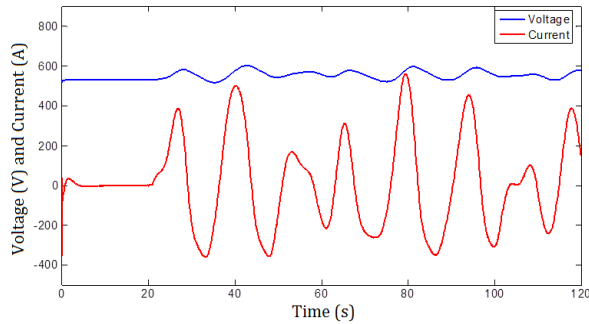

Figure 13. Voltage and current of the SC.

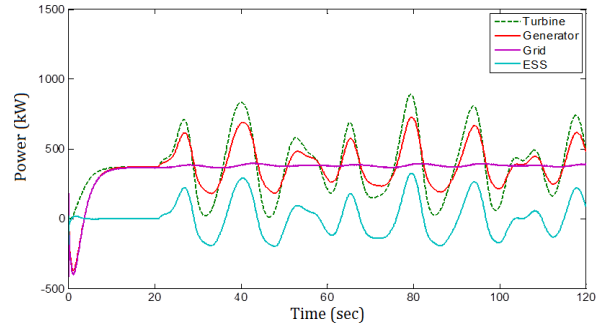

Figure 14. Powers in different parts of the system.

Figure 13 shows voltage and current in the SC for grid power smoothing control. SC has high power density and can be charged/discharged very quickly, therefore it is suitable for compensating the generator power fluctuations caused by swell effect. Figure 14 illustrates the powers in different parts of the system. The active grid power is shown in this figure since the grid reactive power is controlled to zero by the grid-side converter. This result demonstrates that under swell effect the generator power can be firstly smoothed with the proposed generator-side control strategy and the remanent power fluctuations can be compensated by the supercapacitor; then a smoothed grid-injection power can be obtained.

## V. CONCLUSION

In this paper swell modeling and power smoothing control with supercapacitor for a grid-connected marine current turbine are studied. Firstly Swell effect is modeled based on the sea state and the MCT location parameters. The carried-out simulations show that a simple tip-speed ratio MPPT can cause severe power fluctuations in the generator power. So in a first hand, a modified MPPT with filter strategy is proposed. This method utilizes the system inertia to reduce the generator power fluctuation. Simulation results indicates that tuning the filter constant about half typical period of the swell enables to greatly reduce the generator power fluctuations. In a second hand, the supercapacitor is proposed to eliminate the remanent generator power fluctuations. The duty ratio of the SC is controlled through the charge and discharge requirements to achieve a smoothed grid target power. Simulation results have shown the effectiveness of the joint operation of the proposed MPPT and the SC.

## REFERENCES

- [1] Z. Zhou, M.E.H. Benbouzid, J.F. Charpentier, F. Scuiller, and T. Tang, "A review of energy storage technologies for marine current energy systems," *Renewable and Sustainable Energy Review*, vol. 18, pp.390-400, Feb. 2013.
- [2] Z. Zhou, F. Scuiller, J.F. Charpentier, M.E.H. Benbouzid and T. Tang, "Grid-connected marine current generation system power smoothing control using supercapacitors," in *Proceedings of the 2012 IEEE IECON*, Montreal (Canada), pp.4035-4040, Oct. 2012.
- [3] Y. Goda, *Random Seas and Design of Maritime Structures*. Advanced Series on Ocean Engineering, vol.33, World Scientific: Singapore, 2010.
- [4] <http://candhis.cetmef.developpement-durable.gouv.fr/> (last accessed May 2013)
- [5] S. Benelghali, R. Balme, K. Le Saux, M.E.H. Benbouzid, J.F. Charpentier and F. Hauville, "A simulation model for the evaluation of the electrical power potential harnessed by a marine current turbine," *IEEE Journal on Oceanic Engineering*, vol. 32, n°4, pp. 786-797, Oct. 2007.
- [6] Z. Zhou, F. Scuiller, J.F. Charpentier, M.E.H. Benbouzid and T. Tang, "Power Limitation Control for a PMSG-Based Marine Current Turbine at High Tidal Speed and Strong Sea State," in *Proceedings of the 2013 IEEE IEMDC*, Chicago (USA), May. 2013.
- [7] Z. Zhou, F. Scuiller, J.F. Charpentier, M.E.H. Benbouzid and T. Tang, "Power smoothing control in a grid-connected marine current turbine system for compensating swell effect," *IEEE Trans. Sustainable Energy*, 2013.