



HAL
open science

Power Smoothing and Limitation Control of a PMSG-Based Marine Current Turbine under Swell Waves

Zhibin Zhou

► **To cite this version:**

Zhibin Zhou. Power Smoothing and Limitation Control of a PMSG-Based Marine Current Turbine under Swell Waves. JCGE SEEDS 2013, Jun 2013, Saint Nazaire, France. pp.1-7. hal-00874489

HAL Id: hal-00874489

<https://hal.science/hal-00874489>

Submitted on 18 Oct 2013

HAL is a multi-disciplinary open access archive for the deposit and dissemination of scientific research documents, whether they are published or not. The documents may come from teaching and research institutions in France or abroad, or from public or private research centers.

L'archive ouverte pluridisciplinaire **HAL**, est destinée au dépôt et à la diffusion de documents scientifiques de niveau recherche, publiés ou non, émanant des établissements d'enseignement et de recherche français ou étrangers, des laboratoires publics ou privés.

Power Smoothing and Limitation Control of a PMSG-Based Marine Current Turbine under Swell Waves

Zhibin ZHOU^{1,2}

¹Ecole Navale, EA 3634, IRENav, ²Université Occidentale de Brest, EA 4325 LBMS
Ecole Navale, IRENav EA 3634, 29240 Brest Cedex 9, France
zhibin.zhou@ecole-navale.fr

RESUME – Les variations dans la vitesse des courants marins peuvent conduire à des grandes fluctuations sur la puissance produite par une hydrolienne. Pendant une période de courte durée, la houle est la principale cause des variations de vitesse des courants marins. Une stratégie conventionnelle de contrôle de vitesse par suivi de la puissance maximale (MPPT) nécessiterait d’accélérer ou de décélérer fréquemment la turbine à chaque variation de vitesse de courant due à la houle et entraînerait de fortes fluctuations dans la puissance du générateur. Cet article propose des stratégies de contrôle de lissage de la puissance produite par une turbine marine associée à un générateur synchrone à aimants permanents (GSAP). Un algorithme de MPPT modifié avec une stratégie de filtrage est proposé pour le contrôle de la génératrice. Il utilise l’inertie du système pour atténuer la fluctuation de puissance au niveau du générateur. De plus lorsque la vitesse des courants marins est supérieure à une valeur nominale, un contrôle de limitation de puissance doit être appliqué. Un algorithme robuste de défluxage est proposée pour permettre de mettre en œuvre une stratégie de limitation de puissance sur une turbine à pas fixe associée à une GSAP. Dans ce cas, deux stratégies de contrôle basées d’une part sur le contrôle du couple et d’autre part sur celui de la vitesse sont présentées, simulées et comparées en termes d’efficacité.

ABSTRACT – Variations of marine current speed can lead to strong fluctuations in the power extracted by a marine current turbine (MCT). During short-time period, swell effect is the main cause for the current speed variations. Conventional tip speed ratio Maximum Power Point Tracking (MPPT) algorithm will require the MCT to accelerate or to decelerate frequently under swell effect, which can cause severe fluctuations in the generator power. This paper focuses on power smoothing control of a PMSG-Based MCT system. A modified MPPT algorithm with filter strategy is proposed in generator-side control to use the system inertia for smoothing the fluctuation of generator power. When the current speed is over rated value, the power limitation control will be applied. A robust feedback flux-weakening control algorithm is studied for a fixed pitch PMSG-based MCT; both speed loop and torque loop control strategies are simulated and compared to show the power limitation control effects at high marine current speeds.

KEY WORDS – Swell effect, marine current turbine, PMSG, power smoothing control, power limitation, flux-weakening.
Mots clés : Hydrolienne, effets de houle, machine synchrone à aimants, limitation de puissance, pas fixe, défluxage.

1. Introduction

During short-time period, swell waves are the main cause for variations in the marine current speed and can lead to marine current speed fluctuations on a period about 10 to 20 s. These current speed variations could cause high fluctuations in the power harnessed by a marine current turbine (MCT) system if conventional tip-speed ratio Maximum power point tracking (MPPT) is used [1-2]. Therefore, the swell effects and appropriate power smoothing control strategy should be studied for MCT applications.

Due to accessibility difficulty for underwater equipment, compact structure and low maintenance requirements are expected for MCTs. Recent MCTs such as the EDF-OpenHydro system and Alstom Hydro Beluga 9 adopt blades without pitch control to simplify the MCT and use PMSG to realize direct-drive system. For fixed blade turbines, the power limitation which is usually done by pitch angle control should be done with generator-side control strategy. This work focuses on two main points: the first one is to investigate a specific control strategy which reduces the swell-induced power fluctuations. A second point is to propose a power limitation strategy for fixed-pitch MCT for over-rated marine current speeds. Figure 1 shows the general scheme for the PMSG-based MCT system.

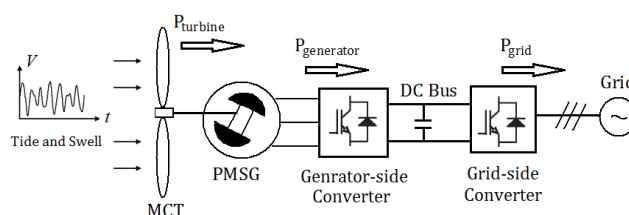

Figure 1. General scheme for a PMSG-based MCT system.

The paper will be divided into three main sections. In Section 2, the swell modeling and the power fluctuation phenomenon will be presented. In Section 3, the turbine power characteristics and the generator-side power smoothing control strategy with an original filter algorithm will be presented. In Section 4, a robust flux-weakening control strategy is applied in a speed control scheme and torque control scheme respectively.

2. Swell effect and power fluctuation

In this paper, the first order Stokes model is used to calculate horizontal speed oscillations induced by swell waves. The total marine current speed is then calculated by the combination of predicted tidal speed and swell effect as follow [1-2].

$$V(t) = V_{\text{tide}} + \sum_i \frac{2\pi a_i}{T_i} \frac{\cosh\left(2\pi \frac{z+d}{L_i}\right)}{\sinh\left(2\pi \frac{d}{L_i}\right)} \cos 2\pi \left(\frac{t}{T_i} - \frac{x}{L_i} + \varphi_i \right) \quad (1)$$

It contains two parts: the first item V_{tide} represents the predicted tidal speed, which can be regarded as a constant during a period of a few minutes; the second term represents the current speed oscillation caused by the swell. Figure 2 shows the main characteristic of one simple swell (x and z represent the horizontal and vertical point for the calculation). More than one frequency component should be considered to model a realistic swell effect. That explains the superposition calculation in the second term of (1). Each swell frequency component is calculated based on a swell spectrum and ocean wave theories; φ_i represents the initial phase angle of each frequency component which is given randomly. Figure 3 shows the swell spectrum (JONSWAP spectrum) used in this paper.

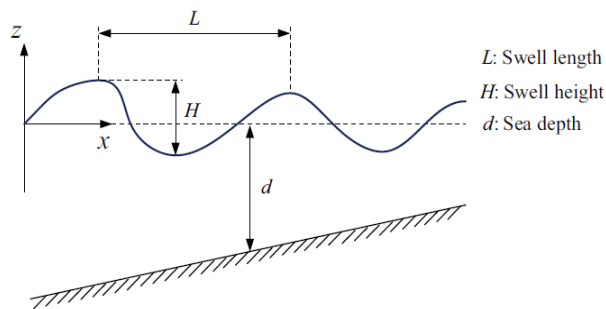

Figure 2. Characteristic of one simple swell wave.

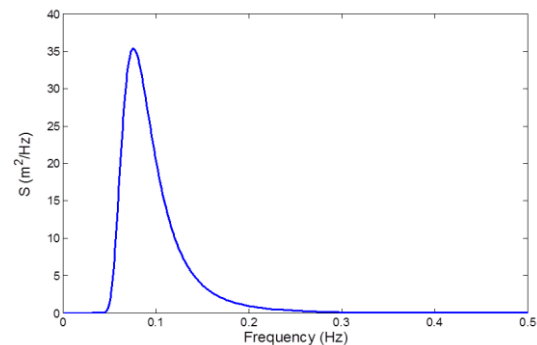

Figure 3. Swell spectrum based on JONSWAP spectrum.

Swells are created from wind waves and travel through long-distant propagation after their generating area. The process of dispersion (low frequency wave components propagate faster than high frequency wave components) takes place during the swell propagation. Thus, the swell observed at a fixed station has a spectrum restricted to a narrow frequency range. In this paper, the JONSWAP spectrum is chosen as the swell spectrum due to its sharp peak characteristic. The JONSWAP spectrum can be written as follow.

$$S(f) = \beta_J \frac{H_s^2}{T_p^4} \frac{1}{f^5} \exp\left(-\frac{4}{5} \frac{1}{T_p^4} \frac{1}{f^5}\right) \gamma^\gamma \quad (2)$$

Where, $\gamma = \exp\left[-\frac{(T_p f - 1)^2}{2\sigma^2}\right]$ with $\sigma = \begin{cases} 0.07, & f \leq 1/T_p \\ 0.09, & f \geq 1/T_p \end{cases}$

The parameter γ is called peak enhancement factor which controls the sharpness of the spectral peak. $\gamma = 3.3$ is the mean value determined for the North Sea. Larger value can be chosen to reflect the sharp peak characteristic of swell waves. The swell spectrum for engineering applications can be approximated by (2) with the peak enhancement factor being chosen between $\gamma = 3\sim 10$, depending on the distance that the swell has traveled [3]. In this paper, the peak enhancement factor is chosen as $\gamma = 7$, and the sea state of $H_s = 3$ m, $T_p = 13.2$ s is considered. This corresponds to typical sea state in the winter for the western coast of France [4]. The amplitude of each frequency components can be calculated by $a_i = \sqrt{2S(f_i) f_i}$. As shown in Fig. 3, the peak frequency in the spectrum is about 0.08 Hz. It corresponds to the peak period $T_p = 13.2$ s. The narrow frequency range and sharp spectral peak illustrates the swell characteristics.

It should be noticed from (1) that the swell effect on marine current speed also depends on the sea depth and the vertical distance between the calculation point and the sea surface. It means that the sea depth and the installation depth of the turbine must be considered to calculate the swell effect on a given MCT system.

In this paper, the turbine size and location parameters are chosen based on the EDF-OpenHydro project near the coast of Paimpol in France (Paimpol Bréhat experimental site). The turbine radius is 8 m and the system is supposed to be located at a sea depth of 35 m as shown in Fig. 4. The equivalent marine current speed for this turbine can be calculated at a depth of 22 m below the sea surface.

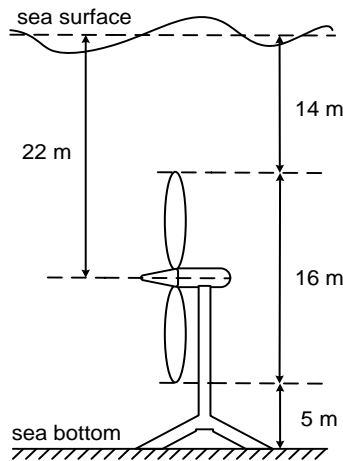

Figure 4. MCT size and location.

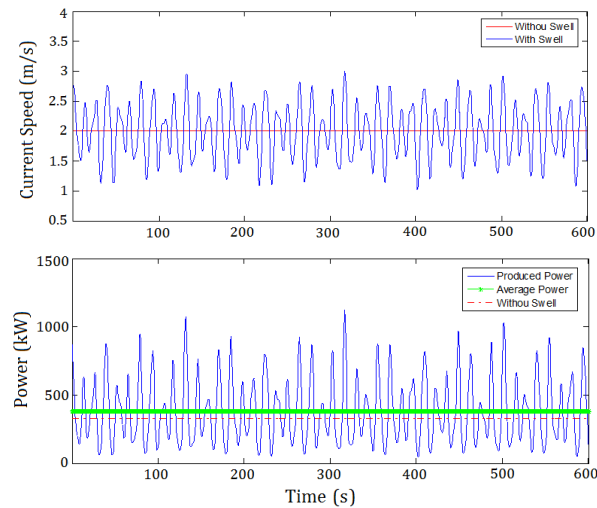

Figure 5. Marine current speed and MCT power.

Figure 5 shows the simulation waveform of total marine current speed and the estimated produced power of the MCT under the swell effect (the tidal speed is assumed as 2m/s in the simulation). It can be seen that the swell effect can induce large oscillations in the marine current speed for the given depth; and these marine current speed oscillations can cause very high fluctuations in the power harnessed by the MCT. One of the challenges of connecting the marine current generation system to the power grid is to obtain a stable and smoothed power even under swell disturbances.

3. Generator-side power smoothing control

3.1 MCT power characteristics

For MCTs, the power extracting principles are similar to wind turbines. The power harnessed by a horizontal-axis MCT can be calculated by the following equation.

$$P = \frac{1}{2} \rho C_p \pi R^2 V^3 \quad (3)$$

In (3), the sea water density ρ and the turbine radius R are considered as constants; V is the marine current speed which is considered to be homogeneous in the turbine disk for each given time; C_p is the turbine power coefficient which depends on the turbine blade structure and its hydrodynamics. For typical MCTs, the optimal C_p value for normal operation is estimated to be in the range of 0.35-0.5 [5]. For a given turbine and based on the experimental results, the C_p curve can be approximated as a function of the tip speed ratio ($\lambda = \omega_m R / V$) and the pitch angle. In this paper the considered system is a fixed pitch MCT, so C_p depends only of λ .

Figure 6 shows the C_p curve used in this paper. The maximum C_p value is 0.45 which corresponds to a tip speed ratio of 6.3. This value is considered as the optimal tip speed ratio (λ_{opt}) for realizing maximum power point tracking (MPPT) under rated marine current speeds.

In this paper, a 1.5 MW direct-driven turbine is studied. The turbine maximum speed to follow MPPT is 25 rpm (2.62 rad/s) for a marine current of 3.2 m/s. When the marine current exceeds 3.2 m/s, the extracted power will be limited to 1.5 MW by power limitation strategies with flux-weakening control. The MCT extractable power under different marine current speeds is calculated by (3) and illustrated by Fig. 7.

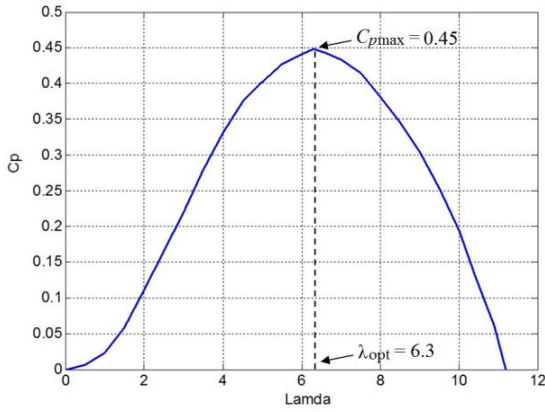

Figure 6. C_p curve of the MCT.

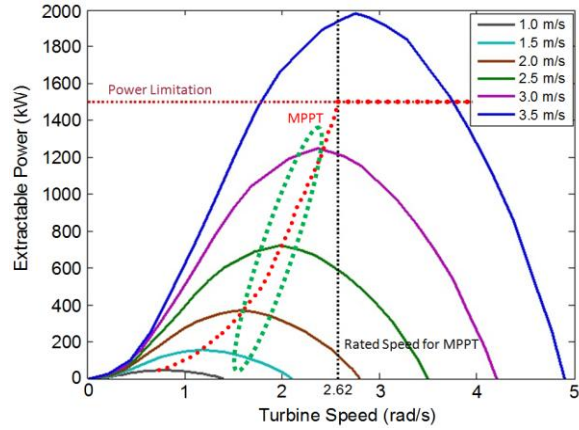

Figure 7. The MCT power characteristics.

3.2 Generator-side power smoothing control

The PMSG model in the d - q frame can be described by the following equations ($L_d = L_q$ in this paper which corresponds to a non-salient machine).

$$\begin{cases} v_d = R_s i_d + L_d \frac{di_d}{dt} - \omega_e L_q i_q \\ v_q = R_s i_q + L_q \frac{di_q}{dt} + \omega_e L_d i_d + \omega_e \Psi_m \\ T_e = \frac{3}{2} n_p \Psi_m i_q \\ J \frac{d\omega_m}{dt} = T_m - T_e - f_B \omega_m \end{cases} \quad (4)$$

In (4), v_d , v_q and i_d , i_q are stator voltages and currents in the d - q frame respectively; R_s is the stator resistance; L_d , L_q are inductances in the d - q frame; ω_e , ω_m are machine electrical and mechanical speed; T_e , T_m are respectively the machine electro-magnetic torque and the turbine mechanical torque; n_p is the machine pole pair number; Ψ_m is the flux linkage created by the rotor permanent magnets; J is the total system inertia and f_B is the friction coefficient associated to the mechanical drive train.

MPPT strategy consists in controlling the rotor speed to keep the turbine tip speed ratio λ at its optimal value, thus keeping the turbine power coefficient C_p at the maximum value. Supposing that the C_p curve is known and the marine current speed V can be obtained by flow velocity measurements, the turbine speed reference calculated by the conventional speed-based MPPT can be expressed as $\lambda_{opt} V/R$. In this paper, a low pass filter is added to modify the rotor speed reference calculated by the conventional MPPT algorithm in case of swell effect. The proposed strategy generates the speed reference as

$$\omega_{m_ref} = \frac{1}{Ts + 1} \cdot \frac{\lambda_{opt} V}{R} \quad (5)$$

where the T is the filter time constant and plays a significant role in reducing the generator power fluctuation caused by swell disturbances. Setting T to zero leads (5) to the conventional MPPT algorithm (the turbine speed reference follow the marine current fluctuation).

With the conventional tip-top ratio speed reference MPPT, the generator power will fluctuate more severely than the turbine power under swell effect. This can be explained as follow: when we neglect the friction losses in the torque equation in (4), we can get

$$P_{turbine} - P_{generator} = \omega_m T_m - \omega_m T_e = \omega_m J \frac{d\omega_m}{dt} \quad (6)$$

From (6), it can be seen the power difference turbine and generator $\Delta P = \omega_m J \cdot d\omega_m / dt$ mainly depends on the system inertia J and the rotor speed change rate $d\omega_m / dt$ when the system has a large inertia and low operational speed. When

the marine current speed changes rapidly under swell effect, the turbine rotor speed will have a synchronous change rate by the conventional MPPT control; $d\omega_m / dt$ is then not negligible. Considering a 1.5 MW MCT system with large total system inertia, the ΔP could be very large.

Figure 8 show the MCT power and generator power profiles using conventional tip-top ratio speed reference MPPT and the proposed MPPT with optimized filter time constant ($T = 7s$) . More detailed analysis can be found in [6]

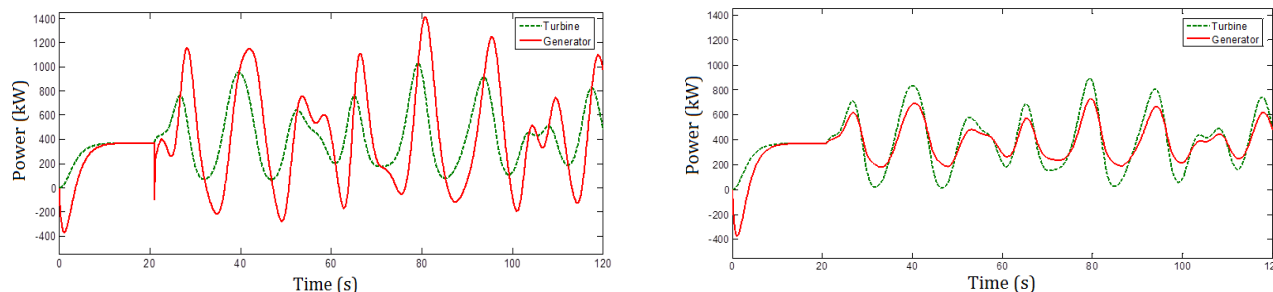

Figure 8. Turbine and generator power responses with conventional MPPT (left) and proposed MPPT (right).

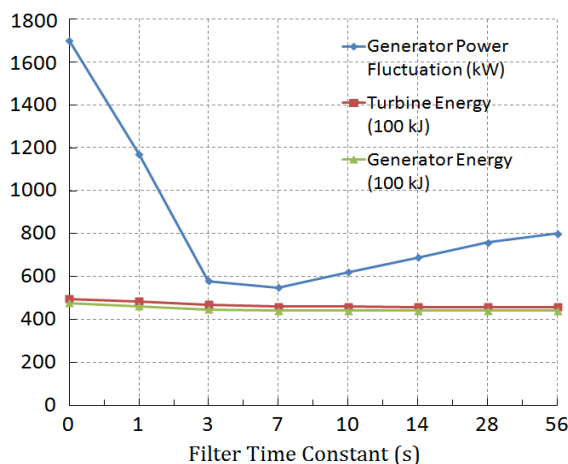

Figure 9. System performances with different filter time constants.

Figure 9 illustrates the system performances with different filter time constants. In this figure, “Generator Power Fluctuation” is calculated by the difference between the maximum and the minimum values of the generator power under swell effect. The energies produced by the turbine and the generator are calculated by integrating the turbine and the generator power respectively. it can be seen that, by adding the filter strategy, the generator power fluctuation is greatly reduced at a cost of slightly energy losses. The energy reduction is due to the deviation from the conventional MPPT points.

4. Power limitation control at high marine currents

In many industrial projects (Sabella, OPENHYDRO, ALSTOM-Beluga) fixed pitch turbine are used to reduce the maintenance constraints and increase the robustness. So when the marine current speed is higher than the rated value, a fixed-pitch MCT is not able to limit the extracted power by pitch control as in classical wind turbines. Therefore, an appropriate generator-side control strategy should be applied to limit the turbine and generator power. Based on the MCT power characteristics, it seems possible to accelerate the turbine speed over the rated rotor speed for limiting the MCT and generator produced power at its rated value .

Figure 10 illustrates the generator-side control scheme with flux-weakening algorithm for realizing high speed operation at MCT power limitation stage. The difference between the current controller output (voltage reference) and the converter output voltage (real machine voltage) is used to produce the i_d reference [7]. The low pass filter (LPF) is used to reject high-frequency components in the voltage signals and thus high-frequency oscillation in the i_d reference can be avoided. The i_q reference is directly calculated by the knowledge of the required torque; This required torque can be obtained by speed control strategy or torque control strategy, which will be discussed in the followed sections.

In the speed control strategy, when the marine current speed is over the rated value, the MPPT mode must be changed to power limitation mode.

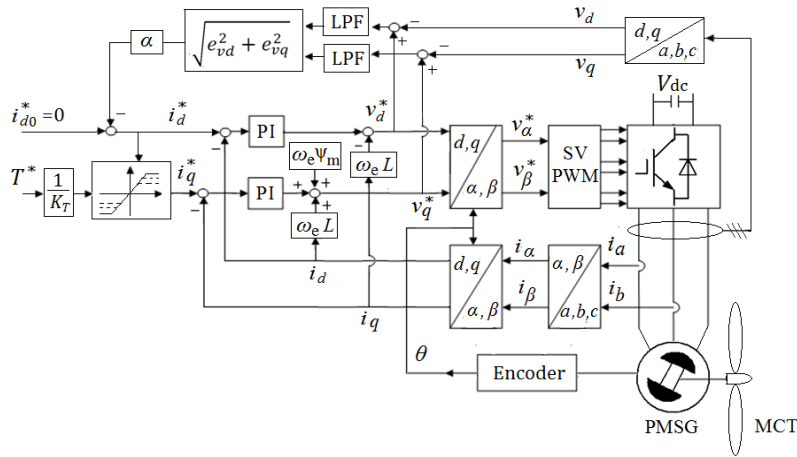

Figure 10. Flux-weakening control scheme for the PMSG.

In this case, the rotor speed reference can be calculated from the turbine power characteristics. The required C_p value is firstly calculated from the generator power limitation value (P_{limit}) and the marine current speed value V . This calculation is based on the turbine power equation (3). The corresponding tip speed ratio is then obtained based on the right part of the C_p curve ($\lambda > \lambda_{opt}$). In this way, the generator power can be speed controlled to the limited value for a given over-rated marine current speed in the steady-state.

In the torque control strategy, at high current speed, the generator torque reference can be calculated by dividing the limitation power with rotor speed ($T_{ref} = P_{limit} / \omega_m$). In this way, the generator torque will be controlled to keep the generator power at the limitation value. Torque control strategy does not require the marine current speed and turbine power characteristics information; it is simple and fast for realizing the power limitation requirement. Equations (7) illustrate the proposed torque control strategy in both MPPT stage and power limitation stage. In (7), T_{ref_max} is the maximum generator torque which can take the value of generator rated torque [8].

$$T_{ref} = \begin{cases} T_{ref_MPPT} = \frac{1}{2} \frac{C_{p_max}}{\lambda_{opt}^3} \rho \pi R^5 \omega_m^2, & T_{ref_MPPT} \leq T_{ref_max} \\ T_{ref_power_limit} = \frac{P_{limit}}{\omega_m}, & T_{ref_MPPT} > T_{ref_max} \end{cases} \quad (7)$$

The over-rated marine current speed (> 3.2 m/s) can happen at high spring tides or at strong sea state caused by storm or extreme swell waves. The over-rated marine current speed caused by extreme sea state is more challenging because of the power fluctuation phenomenon. Figure 11 shows that even the tidal current speed is under the rated value, the total marine current speed could exceed the rated value during some periods due to variations induced by swell effect. The tidal current speed in this section is supposed at 2.8 m/s and the same sea state ($H_s = 3$ m, $T_p = 13.2$ s) as previous is considered.

Figure 12 and 13 show the turbine torque and generator torque responses with speed control and torque control respectively. The turbine torques in both control schemes seem quite similar; this indicates that the resulted power coefficient is similar in the proposed speed control and torque control scheme. However, the generator torques are different due to different control algorithms: the speed control triggers the power limitation mode at every moment when the marine current speed is over the rated value regardless the actual generator power, while the torque control triggers the power limitation mode only when the generator power reaches to the limited value.

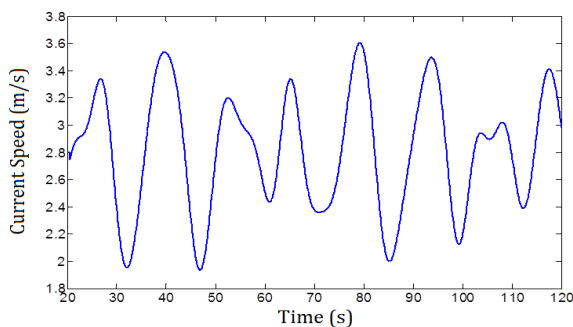

Figure 11. Marine current speed under swells.

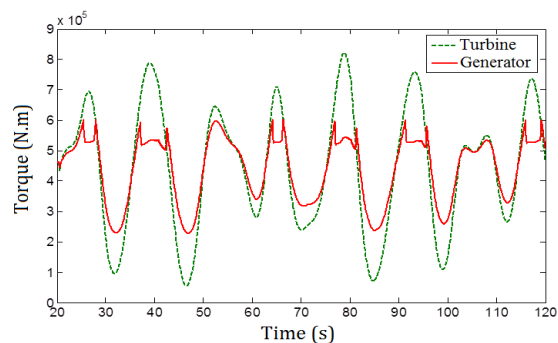

Figure 12. Torque responses with speed control strategy.

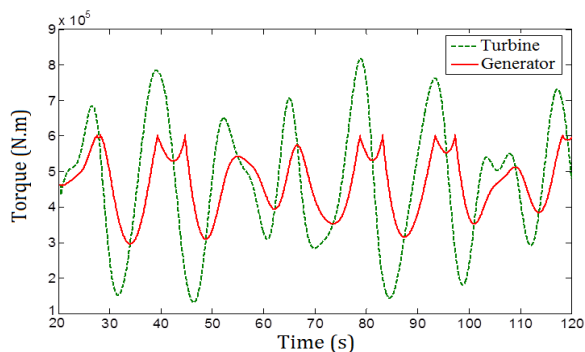

Figure 13. Torque responses with torque control strategy.

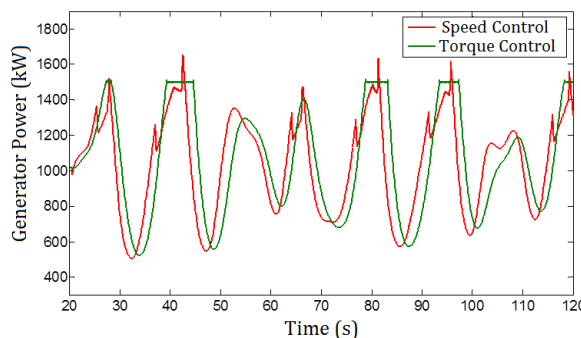

Figure 14. Generator produced power responses comparison.

Figure 14 illustrates and compares the generator produced powers with the speed control and torque control strategies. It shows that torque control strategy is able to limit the PMSG power to 1.5 MW more accurately than the speed control strategy at high marine current speed considering swell effect.

5. Conclusion

In this paper control strategy to limit the influence of swell effects in PMSG fixed pitch tidal turbines are proposed. Firstly Swell effect is modeled based on the sea state and the MCT location parameters. The carried-out simulations show that a simple tip-speed ratio MPPT can cause severe power fluctuations in the generator power. So in a first hand, a modified MPPT with filter strategy is proposed. This method utilizes the system inertia to reduce the generator power fluctuation. Simulation results indicates that tuning the filter constant about half typical period of the swell enables to greatly reduce the generator power fluctuations. In a second hand when the marine current speed exceeds the rated value, power limitation strategy must be used. In this paper a robust flux-weakening control algorithm is proposed to guarantee power limitation of the PMSG fixed pitch turbine by over speed operations. Two control strategies are proposed in this paper for obtaining the appropriate torque reference or q -axis current reference for generator-side power limitation control. Simulation results illustrate that torque control scheme works more efficiently than speed control scheme due to the fact that generator power can be more directly controlled during over-high current speeds.

References

- [1] Z. Zhou, M.E.H. Benbouzid, J.F. Charpentier, F. Scuiller, and T. Tang, "A review of energy storage technologies for marine current energy systems," *Renewable and Sustainable Energy Review*, vol. 18, pp.390-400, Feb. 2013.
- [2] Z. Zhou, F. Scuiller, J.F. Charpentier, M.E.H. Benbouzid and T. Tang, "Grid-connected marine current generation system power smoothing control using supercapacitors," in *Proceedings of the 2012 IEEE IECON*, Montreal (Canada), pp.4035-4040, Oct. 2012.
- [3] Y. Goda, *Random Seas and Design of Maritime Structures*. Advanced Series on Ocean Engineering, vol.33, World Scientific: Singapore, 2010.
- [4] <http://candhis.cetmef.developpement-durable.gouv.fr/> (last accessed April 2013)
- [5] S. Benelghali, R. Balme, K. Le Saux, M.E.H. Benbouzid, J.F. Charpentier and F. Hauville, "A simulation model for the evaluation of the electrical power potential harnessed by a marine current turbine," *IEEE Journal on Oceanic Engineering*, vol. 32, n°4, pp. 786-797, Oct. 2007.
- [6] Z. Zhou, F. Scuiller, J.F. Charpentier, M.E.H. Benbouzid and T. Tang, "Power smoothing control in a grid-connected marine current turbine system for compensating swell effect," *IEEE Trans. Sustainable Energy*, 2013.
- [7] T. S. Kwon, and S. K. Sul, "A novel flux weakening algorithm for surface mounted permanent magnet synchronous machines with infinite constant power speed ratio," in *Proceedings of the 2007 IEEE ICEMS*, Seoul (Korea), pp. 440-445, Oct. 2007.
- [8] Z. Zhou, F. Scuiller, J.F. Charpentier, M.E.H. Benbouzid and T. Tang, "Power Limitation Control for a PMSG-Based Marine Current Turbine at High Tidal Speed and Strong Sea State," in *Proceedings of the 2013 IEEE IEMDC*, Chicago (USA), May. 2013.