



HAL
open science

MIMO Hardware Simulator: Algorithm Design for Heterogeneous Environments

Bachir Habib, Gheorghe Zaharia, Ghaïs El Zein

► **To cite this version:**

Bachir Habib, Gheorghe Zaharia, Ghaïs El Zein. MIMO Hardware Simulator: Algorithm Design for Heterogeneous Environments. *Circuits and Systems*, 2012, 4 (2), pp.217-226. 10.4236/cs.2013.42029 . hal-00870771

HAL Id: hal-00870771

<https://hal.science/hal-00870771>

Submitted on 8 Oct 2013

HAL is a multi-disciplinary open access archive for the deposit and dissemination of scientific research documents, whether they are published or not. The documents may come from teaching and research institutions in France or abroad, or from public or private research centers.

L'archive ouverte pluridisciplinaire **HAL**, est destinée au dépôt et à la diffusion de documents scientifiques de niveau recherche, publiés ou non, émanant des établissements d'enseignement et de recherche français ou étrangers, des laboratoires publics ou privés.

MIMO Hardware Simulator: Algorithm Design for Heterogeneous Environments

Bachir Habib, Gheorghe Zaharia, Ghais El Zein

Institute of Electronics and Telecommunications of Rennes, IETR, UMR CNRS 6164, Rennes, France

Email: bachir.habib@insa-rennes.fr

Received December 4, 2012

Abstract

A wireless communication system can be tested either in actual conditions or by a hardware simulator reproducing actual conditions. With a hardware simulator it is possible to freely simulate a desired type of a radio channel and making it possible to test “on table” mobile radio equipment. This paper presents an architecture for the digital block of a hardware simulator of MIMO propagation channels. This simulator can be used for LTE and WLAN IEEE 802.11ac applications, in indoor and outdoor environments. However, in this paper, specific architecture of the digital block of the simulator is presented to characterize a scenario from indoor to outdoor using TGn channel models. The switching between each environment in the scenario must be made in a continuous manner. Therefore, an Algorithm is designed to pass from a considered impulse response in the environment to another in other environment. The architecture of the digital block of the hardware simulator is presented and implemented on a Xilinx Virtex-IV FPGA. Moreover, the impulse responses are transferred into the simulator. The accuracy, the occupation on the FPGA and the latency of the architecture are analyzed.

Keywords: Hardware simulator; MIMO radio channel; FPGA; 802.11ac signal; Time-varying TGn channel models

1. Introduction

Wireless communication systems may offer high data bit rates by achieving a high spectral efficiency using Multiple-Input Multiple-Output (MIMO) techniques. MIMO systems make use of antenna arrays simultaneously at both transmitter and receiver sites to improve the capacity and/or the system performance. However, the transmitted electromagnetic waves interact with the propagation environment. Thus, it is necessary to take into account the main propagation parameters during the design of the future communication systems. The current communication standards indicate a clear trend in industry toward supporting MIMO functionality. In fact, several studies published recently present systems that reach a MIMO order of 8×8 and higher [1]. This is made possible by advances at all levels of the communication platform, as the monolithic integration of antennas [2] and the simulator platforms design [3].

The objective of our work concerns the channel models and the digital block of the simulator. The design of the RF blocks was completed in a previous project [4].

The channel models can be obtained from standard channel models, as the TGn IEEE 802.11n [5] and the LTE models [6], or from real measurements conducted

with the MIMO channel sounder designed and realized at IETR [7].

In the MIMO context, little experimental results have been obtained regarding time-variations, partly due to limitations in channel sounding equipment [8]. However, theoretical models of impulse responses of time-varying channels can be obtained using Rayleigh fading [9-10].

Tests of a radio communication system, conducted under actual conditions are difficult, because tests taking place outdoors, for instance, are affected by random movements or even by the weather. However, with hardware simulators, it is possible to very freely simulate desired types of radio channels. Moreover, a hardware simulator provides the necessary processing speed and real time performance, as well as the possibility to repeat the tests for any MIMO system. Thus, a hardware simulator can be used to compare the performance of various radio communication systems in the same desired test conditions.

These simulators are standalone units that provide the fading signal/signals of SISO/MIMO channel in the form of analog or digital samples. Some MIMO hardware simulators are proposed by industrial companies like

Spirent (VR5) [11], Azimuth (ACE), Elektrobit (PropSim F8) [12], but they are quite expensive.

With continuing increase of the Field Programmable Gate Array (FPGA) capacity, entire baseband systems can be mapped onto faster FPGAs for more efficient prototyping, testing and verification. Larger and faster FPGAs permit the integration of a channel simulator along with the receiver noise simulator and the signal processing blocks for rapid and cost-effective prototyping and design verification. As shown in [13], the FPGAs provide the greatest design flexibility and the visibility of resource utilization.

The MIMO hardware simulator realized at IETR is reconfigurable with sample frequencies not exceeding 200 MHz, which is the maximum value for FPGA Virtex-IV. The 802.11ac signal provides a sample frequency of 200 MHz. Thus, it is compatible with the FPGA Virtex-IV. However, in order to exceed 200 MHz for the sample frequency, more performing FPGA as Virtex-VII can be used [3]. The simulator is able to accept input signals with wide power range, between -50 and 33 dBm, which implies a power control for the input signals.

At IETR, several architectures of the digital block of a hardware simulator have been studied, in both time and frequency domains [4]. Typically, wireless channels are commonly simulated using finite impulse response (FIR) filters, as in [14, 15, 16]. The FIR filter form a convolution between a channel impulse response and a fed signal in such a manner that the signal delayed by different delays is weighted by the channel coefficients, i.e. tap coefficients, and the weighted signal components are summed up. The channel coefficients are periodically modified to reflect the behavior of an actual channel. Nowadays, different approaches have been widely used in filtering, such as distributed arithmetic (DA) and canonical signed digits (CSDs) [17].

Using FIR filter in a channel simulator has however a limitation. With a FPGA Virtex-IV, it is impossible to simulate a FIR filter with more than 192 multipliers (impulse response with more than 192 taps).

To simulate an impulse response with more than 192 taps, the Fast Fourier Transform (FFT) module can be used. With a FPGA Virtex-IV, the size N of the FFT module can reach 65536 samples. Thus, several frequency architectures have been considered and tested [17]. However, their disadvantages are high latency and high occupation on FPGA.

In this paper, the number of taps is limited to 18 taps for each SISO channel, thus, to 18×4 taps for the 2×2 MIMO channel. Therefore, the time domain architecture is considered because the total number of taps does not exceed 192.

The main contributions of the paper are:

- In general, the channel impulse responses can be presented in baseband with its complex values, or as real signals with limited bandwidth B between $f_c - B/2$ and $f_c + B/2$, where f_c is the carrier frequency. In this paper, to eliminate the f_c and the complex multiplication, the hardware simulation operates between Δ and $B + \Delta$, where Δ depends on the band-pass filters (RF and IF). The value Δ is introduced to prevent spectrum aliasing. In addition, the use of a real impulse response allows the reduction by 50 (%) of the size of the FIR filters and by 4 the number of multipliers. Thus, within the same FPGA, larger MIMO channels can be simulated.
- Tests have been made for indoor [18] and outdoor [19, 20] fixed environments using standard channel models. In this paper, tests are made with scenario that switches between indoor environment and another, or between indoor and outdoor environment to simulate heterogeneous networks [21]. In this context, an algorithm is proposed to switch between the environments in a continuous manner.
- To decrease the number of multipliers on the FPGA and to switch from one environment to another, a solution is proposed to control the change of delays in architecture for time-varying channel.

The rest of this paper is organized as follows. Section 2 presents the channel models and the scenario proposed for the test. Section 3 describes the algorithm designed to switch between environments. Section 4 presents the designed architecture of the digital block of the simulator and its implementation summary on the FPGA. In Section 5, the accuracy of the output signals of the architecture are analyzed. The output SNR for the entire scenario is provided. Lastly, Section 6 gives concluding remarks and prospects.

2. Channel Description

2.1. Proposed Scenario

The proposed scenario covers indoor and indoor-to-outdoor environments at different environmental speed. They consider the movements from an environment to another using an 802.11ac signal which has a 200 MHz sampling frequency (f_s) at a central frequency of 5 GHz. Thus, the sampling period $T_s = 5$ ns.

A person moves from an office environment, to a large indoor environment, then to an outdoor environment. For this scenario, the TGN channel model B, C and E cover the entire channel. Thus, three environments in this scenario are considered.

Figure 1 and Table 1 present the scenario and the movement of the person in it.

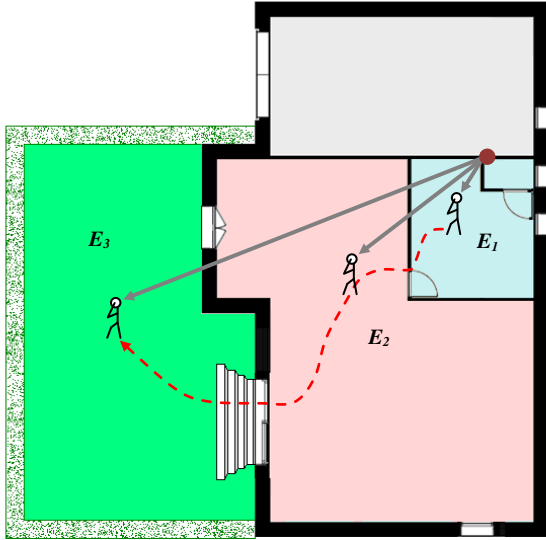

Figure 1. Proposed scenario.

Table 1. Scenario description

	Modèle	v (km/h)	f_d (Hz)	f_{ref} (Hz)	t (s)	d (m)	N_p
E_1	Model B	2	9.25	20	10	5.5	200
E_2	Model C	4	18.5	40	30	133.3	1,200
E_3	Model E	4	18.5	40	60	266.6	2,400

v is the mean environmental speed, f_d is the Doppler frequency, f_{ref} is the refresh frequency between two successive MIMO profiles, t is the time of movements in the considered environment, d is the distance traveled and $N_p = t \times f_{ref}$ is the number of profiles in each environment. f_d is equal to:

—

where c is the celerity. f_{ref} is chosen $> 2.f_d$ to respect the Nyquist-Shannon sampling theorem.

TGn channel models [5] have a set of 6 profiles, labeled A to F, which cover all the scenarios for WLAN applications. Each model has a number of clusters. Each cluster corresponds to specific tap delays, which overlaps each other in certain cases. The relative power of each tap of the impulse response for the considered TGn channel models are presented in Table 2 by taking the LOS path as reference.

RP is the linear relative power; it can be obtained from the relative power in (dB) by:

—

Table 2. Path loss for the considered TGn models

Tap index	TGn model B		TGn model C		TGn model E	
	Excess delay (s)	RP	Excess delay (s)	RP	Excess delay (s)	RP
1	$0.T_s$	1	$0.T_s$	1	$0.T_s$	0.5495
2	$2.T_s$	0.2884	$2.T_s$	0.6166	$2.T_s$	0.5012
3	$4.T_s$	0.5618	$4.T_s$	0.3715	$4.T_s$	0.4467
4	$6.T_s$	0.2584	$6.T_s$	0.2239	$6.T_s$	0.4074
5	$8.T_s$	0.1216	$8.T_s$	0.1380	$10.T_s$	0.9863
6	$10.T_s$	0.0562	$10.T_s$	0.0832	$16.T_s$	0.7586
7	$12.T_s$	0.0275	$12.T_s$	0.3663	$22.T_s$	0.5623
8	$14.T_s$	0.0135	$14.T_s$	0.2207	$28.T_s$	0.4169
9	$16.T_s$	0.0066	$16.T_s$	0.1361	$36.T_s$	0.4677
10	-	-	$18.T_s$	0.0820	$46.T_s$	0.2818
11	-	-	$22.T_s$	0.0427	$56.T_s$	0.1738
12	-	-	$28.T_s$	0.0263	$66.T_s$	0.1047
13	-	-	$34.T_s$	0.0158	$76.T_s$	0.0631
14	-	-	$40.T_s$	0.0095	$84.T_s$	0.0380
15	-	-	-	-	$98.T_s$	0.0295
16	-	-	-	-	$112.T_s$	0.0148
17	-	-	-	-	$128.T_s$	0.0085
18	-	-	-	-	$146.T_s$	0.0035

The maximum relative delay for the last tap for model B is 80 (ns), for model C is 200 (ns) and for model E is 730 (ns). Each tap of each model considers reflection of the wave in the environment. Thus, the scenarios in this paper are considered as scenario models.

Model E is considered for a typical large open space (indoor and outdoor) in Non-Line-Of-Sight (NLOS) conditions. Model C for a large indoor in NLOS conditions. Lastly, Model B for typical office environments in NLOS conditions.

2.2. Time-Varying 2×2 MIMO Channel

In this section, we present the method used to obtain a model of a time variant channel, using the Rayleigh fading. A 2×2 MIMO Rayleigh fading channel [22-23] is considered. The MIMO channel matrix H can be characterized by two parameters:

- 1) The relative power P_c of constant channel components corresponds to LOS.
- 2) The relative power P_s of the channel scattering components corresponds to NLOS.

The ratio P_c/P_s is called Ricean K -factor.

Assuming that all the elements of the MIMO channel matrix H are Rice distributed, it can be expressed for each tap by:

—

where H_F and H_V are the constant and the scattered channel matrices respectively.

The total relative received power $P = P_c + P_s$.
Therefore:

$$\frac{P_c}{P} = \frac{1}{1 + \frac{P_s}{P_c}}$$

If we combine Equation (4) and Equation (5) in Equation (3) we obtain:

$$\frac{P_c}{P} = \frac{1}{1 + \frac{P_s}{P_c}}$$

To obtain a Rayleigh fading channel, K is equal to zero, so H can be written as:

$$H = \frac{1}{\sqrt{2}}(h_1 + jh_2)$$

P is derived from Table 2 for each tap. For 2 transmit and 2 receive antennas:

$$P = \frac{1}{2}(P_c + P_s)$$

where X_{ij} (i -th receiving and j -th transmitting antenna) are correlated zero-mean, unit variance, complex Gaussian random variables as coefficients of the variable NLOS (Rayleigh) matrix H_v .

To obtain correlated X_{ij} elements, a product-based model is used [23]. This model assumes that the correlation coefficients are independently derived at each end of the link:

H_w is a matrix of independent zero means, unit variance, complex Gaussian random variables. R_r and R_t are the receive and transmit correlation matrices. They can be written by:

where ρ is the correlation between channels (between their average signal gain) at two receives antennas, but originating from the same transmit antenna (SIMO). It is the correlation between channels that have the same Angle of Departure (AoD). ρ is the correlation coefficient between channels at two transmit antennas that have the same receive antenna (MISO).

The use of this model has two conditions:

- 1) The correlations between channels at two receive (resp. transmit) antennas are independent from the R_x (resp. T_x) antenna.
- 2) If s_1 (resp. s_2) is the cross-correlation between antennas AoD (resp. AoA) at the same side of the link, then: $s_1 = \cos(\theta_1 - \theta_2)$ and $s_2 = \cos(\theta_1 + \theta_2)$.

and are expressed by :

where $D = 2\pi d/\lambda$, $d = 0.5\lambda$ is the distance between two successive antennas, λ is the wavelength and R_{xx} and R_{xy} are the real and imaginary parts of the cross-correlation function of the considered correlated angles:

The PAS (Power Angular Spectrum) closely matches the Laplacian distribution [24-25]:

$$P(\theta) = \frac{1}{\sigma\sqrt{2\pi}} \exp\left(-\frac{\theta^2}{2\sigma^2}\right)$$

where σ is the standard deviation of the PAS.

3. Algorithm Design

The switch between the environments must be made in continuous manner.

Between E_1 and E_2 for example, the person speed begins accelerating from 2 (km/h) to 4 (km/h). Thus, we consider a mean environmental speed for each environment.

After applying the method used to obtain a 2x2 MIMO time-varying channel presented in Section 2.2, Table 3 presents the relative powers (RP) of the last impulse response of h_{11} in E_1 , the first h_{11} in E_2 , the last h_{11} in E_2 and the first h_{11} in E_3 .

To switch from 9 taps (E_1) with a maximum delay of $16T_s$ to 14 taps (E_2) with a maximum delay of $40T_s$, an algorithm is proposed. Two parameters are considered: the delay of the taps of the impulse responses and their RP :

- 1) As presented in Table 2, the excess delays of the 9 taps in E_1 are equal to the first 9 taps excess delay of E_2 . Therefore, we completed the impulse responses RP vectors of h_{11} in E_1 by $14 - 9 = 5$ zeros that corresponds to the excess delay of E_2 , as presented in Table 3.
- 2) To pass from RP of last h_{11} in E_1 (RP_1) to first h_{11} in E_2 (RP_2), a relation is proposed to increase the RP on each f_{ref} :

$$RP_i = RP_{i-1} \cdot \left(\frac{f_{ref}}{f}\right)^{\alpha}$$

i is an integer that varies from 2 to $f-1$. f_{ref} also changes, as presented in Table 1. It passes from 20 Hz () to 40 Hz ():

f is chosen equal to 80. In fact, the average is equal to 30 Hz. In this case, $80/30 = 2.66$ s needed time to switch between the impulse responses which is sufficient to consider it in continuous manner.

Table 3. Relative power for the considered switching impulse responses for h_{11}

Excess delay (s)	Last h_{11} in E_1	First h_{11} in E_2	Excess delay (s)	Last h_{11} in E_2	First h_{11} in E_3
$0.T_s$	0.5909	0.0489	$0.T_s$	0.0501	0.1323
$2.T_s$	0.2366	0.0818	$2.T_s$	0.0838	0.2525
$4.T_s$	0.7426	0.1668	$4.T_s$	0.1707	0.0590
$6.T_s$	0.2240	0.1080	$6.T_s$	0.1105	0.1267
$8.T_s$	0.0378	0.0529	$8.T_s$	0.0541	0
$10.T_s$	0.1407	0.0632	$10.T_s$	0.0647	0.1825
$12.T_s$	0.0770	0.4477	$12.T_s$	0.4582	0
$14.T_s$	0.0371	0.0547	$14.T_s$	0.0560	0
$16.T_s$	0.0475	0.2312	$16.T_s$	0.2367	0.0931
$18.T_s$	0	0.0955	$18.T_s$	0.0977	0
$22.T_s$	0	0.0941	$22.T_s$	0.0964	0.0459
$28.T_s$	0	0.0070	$28.T_s$	0.0072	0.0990
$34.T_s$	0	0.0543	$34.T_s$	0.0556	0
$40.T_s$	0	0.0561	$36.T_s$	0	0.1608
-	-	-	$40.T_s$	0.0574	0.2281
-	-	-	$46.T_s$	0	0.1553
-	-	-	$56.T_s$	0	0.1479
-	-	-	$66.T_s$	0	0.0421
-	-	-	$76.T_s$	0	0.0631
-	-	-	$84.T_s$	0	0.0301
-	-	-	$112.T_s$	0	0.0393
-	-	-	$128.T_s$	0	0.0262
-	-	-	$146.T_s$	0	0.0215

Figure 2 presents the switch between the last h_{11} in E_1 and the first h_{11} in E_2 for the 80 profile of h_{11} .

To switch from the last h_{11} in E_2 to the first h_{11} in E_3 , the same previous method is used. However, in this case, to consider Equation (15), the excess delay vector of the two impulse responses are summed up to a new excess delay vector that contains all the delays, as presented in Table 3. Moreover, f_{ref} remains the same in this switch. Figure 3 presents the switch between the last h_{11} in E_2 and the first h_{11} in E_3 for the 80 profile of h_{11} .

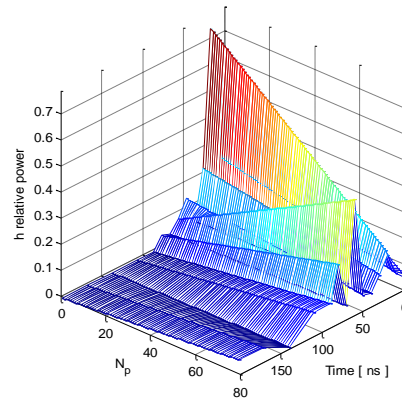
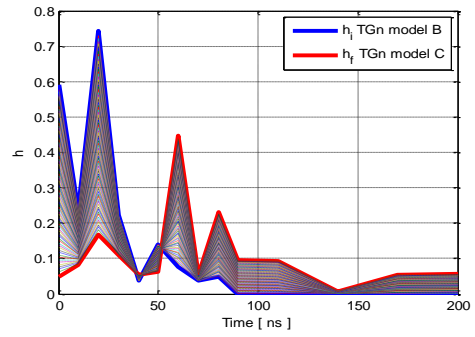

Figure 2. Switching between E_1 and E_2

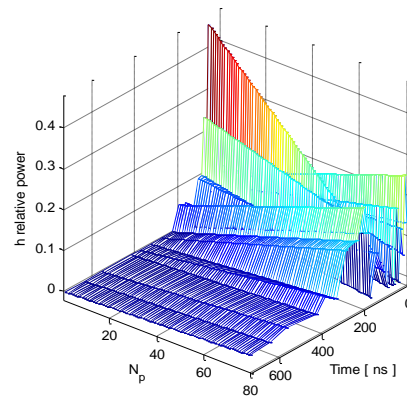
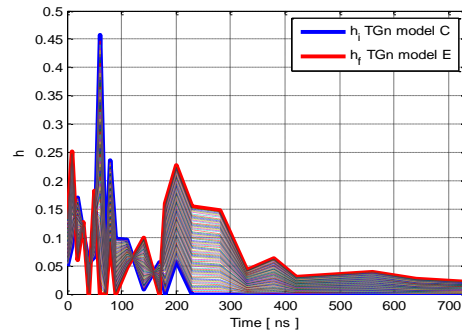

Figure 3. Switching between E_2 and E_3

4. Architecture and Implementation

In this section, the architecture of the digital block of the hardware simulator is presented. The occupation of the architecture on the FPGA is provided. Moreover, the impulse responses transfer process is described.

4.1. Digital Block Architecture

We simulate 2×2 MIMO channel. Therefore, four FIR filters are considered to present the four SISO channels. In general, for each channel the FIR width and the number of used multipliers are determined by the taps of each channel. However, by simulating a scenario all the channels has to be considered. To use limited number of multipliers on the FPGA and to switch from one environment to another, a solution is proposed to control the change of delays in architecture by connecting each multiplier block of the FIR by the corresponding shift register block. Therefore, the number of multipliers in the FIR filters is equal to the maximum number of taps between all channels of all environments. The switch from the last h_{11} in E_2 to the first h_{11} in E_3 needs 23 taps (Table 3). Therefore, 4 FIR filters with 23 multipliers each are considered. Figure 4 presents two SISO channels of the time domain architecture based on FIR 147 filter with 23 multipliers.

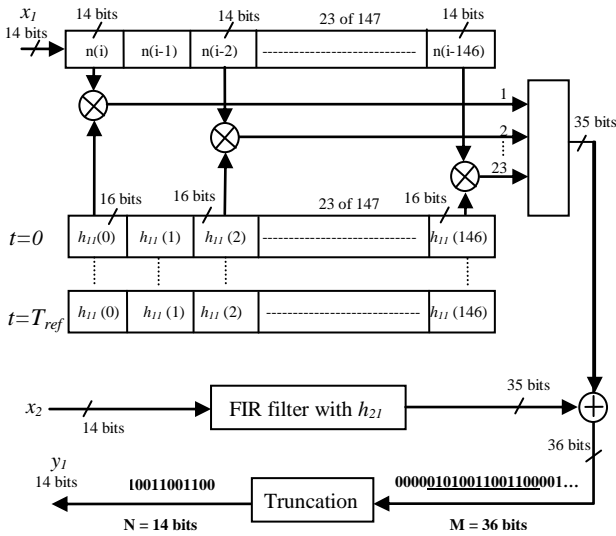

Figure 4. FIR 147 with 23 multipliers for one h_{11} and h_{21}

We have developed our own FIR filter instead of using Xilinx MAC FIR filter to make it possible to

reload the FIR filter coefficients. The general formula for a FIR filter with 23 multipliers is:

In this relation, the index q suggests the use of quantified samples and $h_q(i_k)$ is the attenuation of the k^{th} path with the delay $i_k T_s$.

The truncation block is located at the output of the final digital adder. It is necessary to reduce the number of bits to 14 bits. Thus, these samples can be accepted by the digital-to-analog converter (DAC), while maintaining the highest accuracy. The immediate solution is to keep the first 14 bits. It is a “brutal” truncation (B.T.). This truncation decreases the real value of the quantified output sample. Moreover, $36 - 14 = 22$ bits will be eliminated. Thus, instead of an output sample y , we obtain y' , where μ is the biggest integer number smaller or equal to μ .

However, for low voltages, the brutal truncation generates zeros to the input of the DAC. Therefore, a better solution is the sliding truncation (S.T.) presented in Figure 4 which uses the 14 most significant bits. This solution modifies the output sample values. Therefore, the use of a reconfigurable amplifier after the DAC must be used to restore the correct output value. It must be divided by the corresponding sliding factor.

4.2. Implementation on FPGA Virtex-IV

The Xtreme DSP Virtex-IV board from Xilinx [3] is used for the implementation. The XtremeDSP features dual-channel high performance ADCs (AD6645) and DACs (AD9772A) with 14-bit resolution, a user programmable Virtex-IV FPGA, programmable clocks, support for external clock, host interfacing PCI, two banks of ZBT-SRAM, and JTAG interfaces. The simulations and synthesis are made with Xilinx ISE [3] and ModelSim software [26].

The 2×2 MIMO architectures are implemented in the FPGA Virtex-IV which has 2 ADC and 2 DAC, it can be connected to only 2 down-conversion and 2 up conversion RF units. To test a higher order MIMO array, the use of more performing FPGA as Virtex-VII [3] is recommended.

Table 4 presents the FPGA utilization of 2×2 MIMO time domain architecture using four FIR filters with their additional circuits used to dynamically reload the channel coefficients.

In the FPGA, the clock is controlled by a Virtex-II which is connected to the Virtex-IV.

Table 4: Virtex-IV utilization summary for the 2x2 MIMO architecture.

Logic Utilisation	Used	Available	Utilization
Slice Flip Flops	2,108	30,720	7 %
4 input LUTs	3,951	30,720	13 %
Occupied Slices	3,546	15,360	23 %
Bonded IOBs	40	448	9 %
BUFG/BUFGCTRLs	1	32	3 %
FIFO16/RAMB16s	24	192	12 %
DSP48s	92	192	47 %

4.3. Impulse Responses Transfer

The channel impulse responses are stored on the hard disk of the computer and read via the PCI bus and then stored in the FPGA dual-port RAM. Figure 5 shows the connection between the computer and the FPGA board to reload the coefficients. The successive profiles are considered for the test of a 2x2 MIMO time-varying channel.

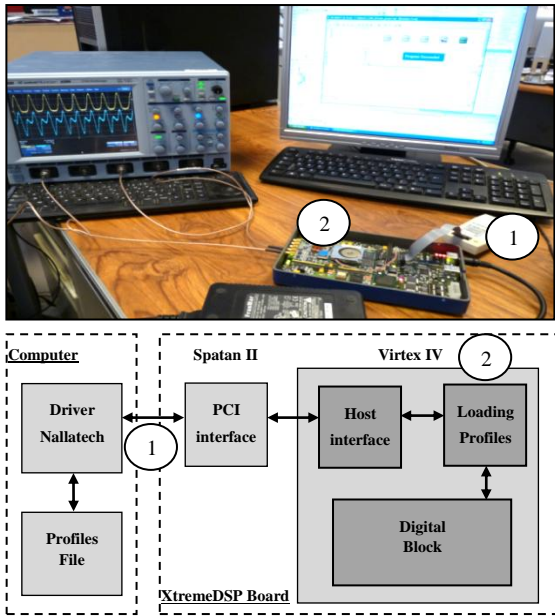

Figure 5. Connection between the computer and the XtremeDSP board.

The maximum data transfer of the impulse responses is: $23 \times 4 = 92$ words of 16 bits = 184 bytes to transmit for a MIMO profile, which is: $184 \times f_{ref}$ (Bps). f_{ref} depends on each environment in the scenario. For E_1 it is 3.680 (kBps) and for E_2 and E_3 it is 7.360 (kBps).

The MIMO profiles are stored in a text file on the hard disk of a computer. This file is then read to load the

memory block which will supply RAM blocks on the simulator (one block for each tap of the impulse response). Each block RAM has a memory of 64 (kB), thus 512 (kbits). The impulse responses are quantified on 16 bits, therefore, up to 32,000 MIMO profiles can be supplied in the RAM blocks. Each environment needs 4 blocks RAM for the power of the impulse responses and 4 blocks for the delays, which is a total of 8 blocks RAM. Reading the file can be done either from USB or PCI interfaces, both available on the used prototyping board. The PCI bus is chosen to load the profiles. It has a speed of 30 (MB/s). In addition, this is a bus of 32 (bits). Thus, on each clock pulse two samples of the impulse response are transmitted.

The Nallatech driver in Figure 5 provides an IP sent directly to the "Host Interface" that reads it from the PCI bus and stores these data in a FIFO memory. The module called "Loading profiles" reads and distributes the impulse responses in "RAM" blocks. While a MIMO profile is used, the following profile is loaded and will be used after the refresh period.

5. Accuracy

In order to determine the accuracy of the digital block, a comparison is made between the theoretical and the Xilinx output signals.

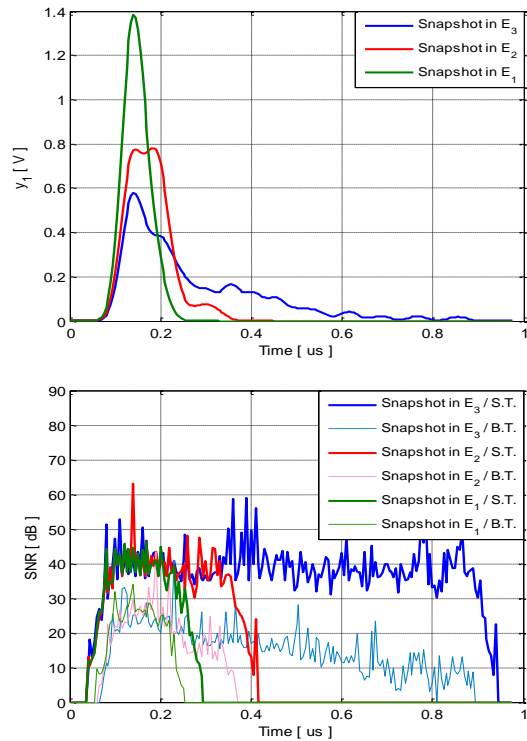

Figure 6. Three Snapshots of y_1 in E_1 , E_2 and E_3 respectively with their SNR.

An input Gaussian signal $x(t)$ is considered for the two inputs of the 2×2 MIMO simulator. The use of a Gaussian signal is preferred because it has a limited duration in time domain. To simplify the calculation, we consider $x_1(t) = x_2(t)$:

where $W_t = 50.T_s$, $m_x = 25.T_s$ and $\sigma = 4.T_s$ (small enough to show the effect of each tap on the output signal).

The A/D and D/A converters of the development board have a full scale $[-V_m, V_m]$, with $V_m = 1$ V. For the simulations we consider $x_m = V_m/2$. The theoretic output signals are calculated by:

For $x_1(t) = x_2(t)$:

and in this case, the occupation on FPGA is decreased if h_{11} and h_{21} (respectively h_{12} and h_{22}) are summed before charging to the RAM blocks. In fact, two channels will be simulated instead of four. The number of RAM blocks and multipliers will be divided by 2. Thus, the occupation on FPGA of 4×4 MIMO channel (with the same input signals) is equal to the occupation of 2×2 MIMO channel (with different input signals).

The relative error is given for each output sample by:

where y_{xilinx} and y_{theory} are vectors containing the samples of corresponding signals and y_{theory} equal to y_1 or y_2 . The Signal-to-Noise Ratio (SNR) is:

where N and M is the maximum number of the last tap between h_{11} and h_{21} , or between h_{12} and h_{22} .

Three Snapshots of y_1 in E_1 , E_2 and E_3 respectively with their SNR are presented in Figure 6.

For TGN channel model B (E_1), the effect of the channel on the input signals is negligible. In fact, the length of the impulse responses is 14 (very low if we compare it to the length of 6σ). However, TGN channel model C (E_2) and E (E_3), the maximum length of the impulse responses is high which will affect the input signals. As shown in Figure 6, the SNR is low for small values of the output signal.

The global values of the relative error and of the SNR computed for the output signal before and after the final truncations are necessary to evaluate the accuracy of the architecture. The global relative error is computed by:

The global SNR is computed by:

where $E = y_{xilinx} - y_{theory}$ is the error vector.

For a given vector $X = [x_1, x_2, \dots, x_L]$, its Euclidean norm $\|x\|$ is:

Table 5 shows the mean global values of the SNR between the Xilinx output signal and the theoretical output signal using 2×2 MIMO time domain architecture for all the profiles in each environment. The results are given with brutal truncation and with sliding truncation. It has been shown that the sliding truncation increase the SNR about 30 to 40 (dB).

Table 5: The Mean Global relative error and SNR

	Brutal truncation		Sliding truncation	
	y_1	y_2	y_1	y_2
Mean Global Relative error (%)				
E_1	0.3438	0.4785	0.0126	0.0169
E_2	0.5272	0.5067	0.0132	0.0127
E_3	1.1874	1.1822	0.0156	0.0202
Mean Global SNR (dB)				
E_1	49.27	46.39	78.02	75.51
E_2	45.54	45.88	77.58	77.92
E_3	38.45	38.49	76.16	73.89

6. Conclusion

In this paper, specific architecture of the digital block of the simulator is presented to characterize a scenario from indoor to outdoor using TGN channel models. An algorithm has been proposed and tested to switch between the environments in a continuous manner. Also, to decrease the number of multipliers on the FPGA and to switch from one environment to another, a solution is proposed to control the change of delays in architecture for time-varying channel. The impulse responses have been implemented in the digital block of the simulator.

The time domain architecture used for the design of the digital block represents the best solution, especially for MIMO systems. In fact, it occupies just 23 % of slices on the FPGA Virtex-IV. Also, it has a small latency of 125 (ns).

Moreover, a study of the architecture accuracy for time-varying 2×2 MIMO channel has been presented. It showed that the SNR increases of about 30 to 40 (dB) using a sliding truncation.

For our future work, simulations made using a Virtex-VII [3] XC7V2000T platform will allow us to simulate up to 300 SISO channels. In parallel, measurement campaigns will be carried out with the MIMO channel sounder realized by IETR to obtain the impulse responses of the channel for various types of environments. The final objective of these measurements is to obtain realistic MIMO channel models in order to supply the hardware simulator. A graphical user interface will also be designed to allow the user to reconfigure the simulator parameters.

7. Acknowledgements

The authors would like to thank the “Région Bretagne” for its financial support of this work, which is a part of PALMYRE-II project.

REFERENCES

- [1] S. Behbahani, R. Merched, A. Eltawil, “Optimizations of a MIMO relay network”, *IEEE Trans. on Signal Processing*, Vol. 56, No. 10, Oct. 2008, pp. 5062–5073.
- [2] A. Cetiner, E. Sengul, E. Akay, E. Ayanoglu, “A MIMO system with multifunctional reconfigurable antennas”, *IEEE Antennas Wireless Propag. Lett.*, Vol. 5, No. 1, Dec. 2006, pp. 463–466.
- [3] “Xilinx: FPGA, CPLD and EPP solutions”, www.xilinx.com.
- [4] S. Picol, G. Zaharia, D. Houzet, G. El Zein, “Design of the digital block of a hardware simulator for MIMO radio channels”, *IEEE PIMRC*, Helsinki, Finland, Sep. 2006.
- [5] V. Erceg, L. Schumacher, P. Kyritsi, et al., “TGn Channel Models”, IEEE 802.11-03/940r4, May 10, 2004.
- [6] Agilent Technologies, “Advanced design system – LTE channel model - R4-070872 3GPP TR 36.803 v0.3.0”, 2008.
- [7] H. Farhat, R. Cosquer, G. Grunfelder, L. Le Coq, G. El Zein, “A dual band MIMO channel sounder at 2.2 and 3.5 GHz”, *Instrumentation and Measurement Technology Conference Proceedings*, Victoria, Canada, May 2008.
- [8] P. Almers, E. Bonek et al., “Survey of Channel and Radio Propagation Models for Wireless MIMO Systems”, *EURASIP Journal on Wireless Communications and Networking*, Article ID 19070, 2007.
- [9] J. Salz, J.H. Winters, “Effect of fading correlation on adaptive arrays in digital mobile radio”, *IEEE Trans. on Veh. Technol.*, Vol. 43, No. 4, AT&T Bell Labs, Holmdel, NJ, Nov. 1994, pp. 1049-1057.
- [10] L. Schumacher, K. I. Pedersen, P.E. Mogensen, “From antenna spacings to theoretical capacities – guidelines for simulating MIMO systems”, in *Proc. PIMRC Conf.*, Vol. 2, Sept. 2002, pp. 587-592.
- [11] “Wireless Channel Emulator”, Spirent Communications, 2006.
- [12] “Baseband Fading Simulator ABFS, Reduced costs through baseband simulation”, Rohde & Schwarz, 1999.
- [13] P. Murphy, F. Lou, A. Sabharwal, P. Frantz, “An FPGA Based Rapid Prototyping Platform for MIMO Systems”, *Asilomar Conf. on Signals, Systems and Computers, ACSSC*, Vol. 1, 9-12 Nov. 2003, pp. 900-904.
- [14] Umansky, M. Patzold, “Design of Measurement-Based Stochastic Wideband MIMO Channel Simulators”, *IEEE Globecom*, Honolulu, Nov. 2009.
- [15] S. Fouladi Fard, A. Alimohammad, B. Cockburn, C. Schlegel, “A single FPGA filter-based multipath fading emulator”, *Globecom*, Honolulu, Nov. 2009.
- [16] M. Al Mahdi Eshtawie, M. Bin Othma, “An algorithm proposed for FIR Filter coefficients representation”, *World Academy of Science, Engineering and Technology*, 2007.
- [17] H. Eslami, S.V. Tran, A.M. Eltawil, “Design and implementation of a scalable channel Emulator for wideband MIMO systems”, *IEEE Trans. on Vehicular Technology*, Vol. 58, No. 9, Nov. 2009, pp. 4698-4708.
- [18] B. Habib, G. Zaharia, G. El Zein, “MIMO Hardware Simulator: Digital Block Design for 802.11ac Applications with TGn Channel Model Test”, *IEEE VTC Spring*, Yokohama, Japan, May 2012.
- [19] B. Habib, G. Zaharia, G. El Zein, “Digital Block Design of MIMO Hardware Simulator for LTE Applications”, *IEEE ICC*, Ottawa, Canada, June 2012.
- [20] K. Borries, E. Anderson, P. Steenkiste, “Network-Scale Emulation of General Wireless channels”, *IEEE VTC Fall*, San Francisco, USA, Sep. 2011.
- [21] A. Damnjanovic, et al., “A survey on 3GPP heterogeneous networks”, *IEEE Wireless Communications, Qualcomm inc.*, June 2011.
- [22] W. C. Jakes, “Microwave mobile communications”, *Wiley & Sons*, New York, Feb. 1975.
- [23] J. P. Kermoal, L. Schumacher, K. I. Pedersen, P. E. Mogensen, F. Frederiksen, “A stochastic MIMO radio channel model with experimental validation”, *IEEE Journal on Selected Areas of Commun.*, Vol. 20, No. 6, Aug. 2002, pp. 1211-1226.
- [24] Q. H. Spencer, et al., “Modeling the statistical time and angle of arrival characteristics of an indoor environment”, *IEEE J. Select. Areas Commun.*, Vol. 18, No. 3, March 2000, pp. 347-360.
- [25] C-C. Chong, D. I. Laurenson, S. McLaughlin, “Statistical Characterization of the 5.2 GHz wideband directional indoor propagation channels with clustering and correlation properties”, in *proc. IEEE Veh. Technol. Conf.*, Vol. 1, Sept. 2002, pp. 629-633.
- [26] “ModelSim - Advanced Simulation and Debugging”, <http://model.com>.