



HAL
open science

Design theories as languages for the unknown: insights from the German roots of systematic design (1840-1960).

Pascal Le Masson, Benoit Weil

► To cite this version:

Pascal Le Masson, Benoit Weil. Design theories as languages for the unknown: insights from the German roots of systematic design (1840-1960).. *Research in Engineering Design*, 2013, 24 (2), pp.105-126. 10.1007/s00163-012-0140-2 . hal-00870336

HAL Id: hal-00870336

<https://hal.science/hal-00870336v1>

Submitted on 7 Oct 2013

HAL is a multi-disciplinary open access archive for the deposit and dissemination of scientific research documents, whether they are published or not. The documents may come from teaching and research institutions in France or abroad, or from public or private research centers.

L'archive ouverte pluridisciplinaire **HAL**, est destinée au dépôt et à la diffusion de documents scientifiques de niveau recherche, publiés ou non, émanant des établissements d'enseignement et de recherche français ou étrangers, des laboratoires publics ou privés.

Design theories as languages of the unknown: insights from the German roots of systematic design (1840-1960)

Pascal Le Masson^{*1}, Benoit Weil¹.

¹ Mines ParisTech

60 Boulevard Saint Michel, F-75 272 Paris Cedex 06, France

lemasson@ensmp.fr, bweil@ensmp.fr

tel : +33 1 40 51 92 21, fax : +33 1 40 51 90 65

* corresponding author

Paper submitted for the special issue of RIED on design theory

Abstract

In this paper, we analyse the development of design theories in the particular case of German systematic design. We study three moments in the development of design theories (1850, 1900 and 1950). The analysis leads to three main research conclusions regarding design theorizing. 1) The development of design theories and methods corresponds to specific rationalizations of the design activity in historical contexts, characterized by types of products, science and knowledge production capacities. 2) While engineering sciences model known objects, design theories support reasoning on unknown objects. 3) Design methods do not target single innovations but aim to improve collective design capacities. Their performance can be assessed by the types of new objects they help design (generative capacity) and in terms of the capacities required by their users (conjunctive capacity). Historically, systematic design emerged as a formal framework with particularly strong generative and conjunctive capacities.

Aknowledgement:

This research was carried out with support from the French National Research Agency Entrepise Programme, as part of the RITE Project (ANR-07-ENTR-011-RITE) and from the Chair of Design Theory and Methods for Innovation. We especially thank Mme Maisonneuve, head of antique books and special collections in the MINES ParisTech library. Our special thanks to Ulrich Wengenroth for his precious comments. We warmly thank Patrick Fridenson for his strong support for this work.

1. Introduction

The renewal of design theories in recent decades (see the recent synthesis in {Hatchuel, 2011 #2562}) calls for a better understanding of the development of past theories and methods. It may help us to understand how design theories were gradually elaborated and to become more aware of their nature and their purposes.

Today, one of the most common modes of reasoning taught and used to design products and services in engineering and design departments is so-called ‘systematic design’. The reference work by Pahl and Beitz (Pahl and Beitz 1977) and those that stemmed from it have been used to teach generations of design engineers. The term systematic design often refers to a heterogeneous set of theories and methods that include abstraction, establishing function structure, searching for solution principles, combining solution principles, etc. These specific techniques contribute to a design process based on different ways of describing the emerging object, such as the sequence mentioned by Pahl & Beitz: clarification of the task (described in the language of requirements), conceptual design (described in the language of technological models), embodiment design (described in the language of components and relations), detailed design (described in the language of dimensions), etc. These languages and their hierarchy are largely shared. Even in experimental studies on the use of systematic design methods, the designers’ work is described in these languages (Ehrlenspiel 1995). These methods have been widely criticized. For instance, several works (Ehrlenspiel 1995) indicated their limited efficiency in real cases and underlined that designers often do not use them in practice. But the theoretical and contingent aspects of these methods are largely unknown. The variety of methods that can be related to systematic design might suggest a kind of methodological relativism; it is nonetheless interesting to try to identify the historical trends and tensions underlying their elaboration. What are the historical roots of systematic design methods and theories? This is our main research issue. More precisely, in this paper we address three questions:

- 1) Why did theories and methods of systematic design come about? (Q1)
- 2) Which specific features characterize the design theory (or theories) that underlie these systematic design methods? (Q2)
- 3) What is their area of relevance – ie what were their fundamental hypotheses regarding the relevant uses and users of these methods? (Q3)

In the first part we detail our theoretical background and research method; in the three following parts we investigate the above-mentioned questions at three historical moments, considered the main sources of the elaboration of systematic design methods.

2. Theoretical background and research method

Before giving more details of the research hypotheses linked to these three research questions, we would like to insist on the subject of this paper. We do not intend to provide evidence to validate the *(design) methods* or to compare the methods related to real cases. Our aim is to characterize and compare the *theories*, ie the formal elaborations behind the methods. A method is a reasoned process for action; there is an explicit or tacit theory underlying this reasoned process. For instance, in statistics the parameters of a distribution can be estimated using the method of maximum likelihood or the Bayesian estimation method. The two methods can be compared in one specific statistical exercise; still an attempt can be made to identify the statistical *theories* underlying them, ie classical statistical inference in the former and Bayesian statistical decision theory in the latter case. In this second perspective, these statistical frameworks can then be compared in terms of their hypotheses, consistency, etc. and their relationship to one another (is one more general than the other?) In this paper, we address the design theories underlying the methods that were developed in Germany and built the corpus of the systematic design methods. Our research questions correspond to three features of the underlying theoretical elaborations. For Q1, what is the action logic that led the authors to propose the theories? For Q2, what are the main features of the theories? For Q3, what is the area of relevance of the theories? Let us start with more details of the theoretical background to these questions.

Q1: Who produced design theories and methods and what was the action logic of the authors? Two approaches are often contrasted (Finger and Dixon 1989): the authors either ‘describe’ existing practices (descriptive theories) or try to impose modes of thinking stemming from formal research

(normative theories). This distinction relies on two features that we will analyse for each theory/method:

a) Does it describe actual practices or does it propose a new practice? We will analyse how the authors described the practices of their time and how they compared with the contemporary manuals that they considered to be the contemporary reference. We will show that the theories and methods in our historical sample took into account existing practices but proposed new forms of actions that did not correspond exactly to the practices (they were often considered “too abstract” by their contemporaries);

b) What are the authors’ claims? Do they claim to seek precision, rigour or efficiency? We will study the authors’ explanations concerning the origins and motivations of their works. We will analyse the authors’ claims and some testimonies given by the ‘customers’ (former students who became technicians or chief engineers; entrepreneurs). Note that these testimonies cannot be considered as proof of the efficiency of the theory/method but only as proof of the *nature* of the claims. These elements will show that most of the theories and methods claim to improve design practice by inventing new forms of action.

On this basis, we propose that design theories and methods were actually developed with a logic of rationalization, ie the invention of a new form of action, neither a description nor a purely formal construction disconnected from action.

Q2: Which specific features characterize the design theory (or theories) that underlie these systematic design methods? Heymann (Heymann 2005) for instance characterized the methods by the relative importance they gave to scientific knowledge and practical experience. Are the theories underlying these methods theories of objects, of machines, forces or mechanics? Or are they ‘theories of the method’? In the latter case, in what respect were they specific compared, for instance, with work on experimental methods, on epistemology, on logic or on optimisation and problem-solving methods?

To answer this question, we rely on a general design reasoning model, C-K design theory (Hatchuel and Weil 2003; Hatchuel and Weil 2009). C-K theory makes use of two spaces: (1) K – the knowledge space – is a space of propositions that have a logical status; and (2) C – the concepts space – is a space containing concepts that are propositions, or groups of propositions that have no logical status (ie are undecidable propositions) in K. This means that when a concept is formulated, it is impossible to prove that it is a proposition in K. Design is defined as a process that generates concepts from an existing concept or transforms a concept into knowledge, ie propositions in K.

Concepts can only be partitioned, they can not be “explored” in C only, since their exploration requires to add attributes coming from K. If we add new properties ($K \rightarrow C$) to a concept, we partition the C-set into subsets; if we subtract properties, we include the set in a set that contains it. No other operation is permitted. After partitioning or inclusion, concepts may still remain concepts ($C \rightarrow C$), or can lead to the creation of new propositions in K ($C \rightarrow K$). The two spaces and four operators (including the $K \rightarrow K$) are shown in Figure 1.

A space of concepts is always tree structured as the only operations allowed are partitions and inclusions and the tree has an initial set of disjunctions.

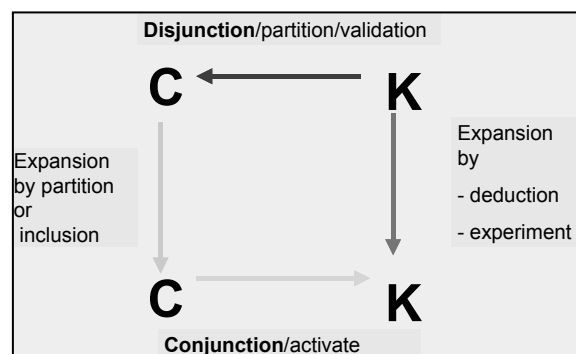

Figure 1: The design square modelled by C-K theory (Hatchuel and Weil 2003)

In this perspective, design theories can be interpreted as a particular class of the C-K theory, specifying certain structures in the knowledge space (object modelling, structuring of knowledge into professions and disciplines, entity-relation structure, type of logic, etc.), certain structures of C

or structures for operators (for decision-making, evaluation, creativity, etc.) (Kazakçi et al. 2008). The theory is therefore a combination of structures in K (models of known), those in C (tiering of gradual refinements) and the operators (divergence, evaluation and selection at each level). In this way, the formal framework provides a basis for discussions on the critical elements gradually provided by the proposed theories. Do the efforts target the K structures, the C structures, or those of the operators?

More precisely, we will rely on C-K theory to describe, for each method, two facets:

a) The type of knowledge and knowledge operators ($K \rightarrow K$) it uses: we call it the language of the known, on which the method is based. This language often takes the form of rules that apply to known objects.

b) The type of $C \rightarrow K$, $K \rightarrow C$ and $C \rightarrow C$, and combinations of operators linked to C-space that the method uses: these operators link the unknown (C) to the known (K). They build a language of the unknown. Like any language, it can be both semantically and syntactically rich. Semantic refers to the type of meaning the language conveys; syntax refers to the laws that rule a rigorous sentence in the language. Here again, we will find ‘rules’, but ones that organize the relationship between the known and the unknown.

We show that most of the design theories and methods that we analysed are not limited to a language of the known (whether scientific or not) but in fact consist in building a language of the unknown related to the known.

Q3: What is the area of relevance of the methods – ie what were their fundamental hypotheses regarding the relevant uses and users of these methods?

The relevant uses and users correspond to classical criteria used to characterize design methods and theories, ie generativity and robustness. Generativity is the capacity to generate a ‘novel’ object with desired properties, different from any other known object and that cannot be deduced from existing knowledge (Hatchuel et al. 2011). It can be characterized by the variety and originality of the objects that a theory/method is supposed to address, ie the relevant uses of the method. More formally, based on C-K theory, it can be characterized by the K-expansions and C-expansions that a method/theory will enable, given the initial knowledge.

Robustness is the capacity of a design to meet expected levels of performance in spite of variations in context and users. It can be characterized by the knowledge that the user has to add to make use of the theory/method. The more knowledge a user has to add, the less robust the method. Note that to test whether a method is ‘efficient’ in practice, the user(s)’ ability to fulfil these conditions must be taken into account. Or to put it another way, if a method doesn’t work ‘in (one) practice’ this might be due to the fact that the user(s) failed to fulfil the prerequisites of the theory. Once again, more formally, we can identify these prerequisites based on C-K theory: they are the Ks and operations that are *not* formalized in the method/theory but are still indispensable to describe a design process based on the method under investigation. The more such conditions exist, the more prerequisites the user has to fulfil, or conversely, the less the chances of a lay user obtaining a final conjunction by using the method, ie the weaker the ‘conjunctive power’ of the method.

Hence, for each method, we will characterize the type of variety and originality it can address – its generativity — and the kind of prerequisites the users have to meet, which will characterize the robustness of the method and its conjunctive power. We show that over time, design theory/methods tend to increase in generativity while remaining reasonably robust.

Based on this research background, our research method unfolds as follows:

- 1- *Focus on main historical moments.* As we could not examine all the methods and theories in German history from the 19th and 20th centuries, we focused on seminal ones, ie the theories and methods that were largely discussed, accepted, widespread and finally used as references by the authors in the following period. In that sense we followed a ‘genealogical perspective’: we identified the roots of the contemporary systematic design methods and the roots of these roots. We identified three main moments: the method of ratios and the origins of machine design theories, the first *Maschinenbau* theory in the 1850s (1840-1900); the tentative to solve the “opposition between theory and practice” that resulted in new types of “machine elements” at the turn of the century; and the birth of systematic construction in the post-war German Democratic Republic.
- 2- *Use of multiple historical sources.* We relied on works by the German historians of design methods/theories Wolfgang König (König 1999) and Matthias Heymann (Heymann 2005),

plus Klaus Mauersberger on Bach (Mauersberger 1998) and Dietrich Severin on Reuleaux (Severin 2000). We consulted manuals (in German and French) by the leading German professors of the 19th century¹ and the 20th century², some French, English and American works on machine design dating from the beginning of the 19th century³; articles in journals and books published by the professors⁴; and we used several biographies for Redtenbacher⁵. We also studied the industrial context of the time and the leading corporations with which many of these professors were in contact⁶. These sources will be indicated when necessary in the following text. It is interesting to note that the main historical sources were not translated into English, which may explain why several elements of this history are hardly covered at all in the English literature. This also raises some translation issues, already mentioned by Wallace in his translation of Pahl & Beitz' Konstruktionslehre (Wallace and Blessing 2000). In the following, we follow the choices made by Ken Wallace, departing from them for just one term, Konstruktion. We consider that although 'design' is a correct translation of the term, it might be misleading in the context of this paper and we prefer the term 'construction', closer to the German word. There are other words in German for design (Entwerfen, Gestaltung, etc.), so we account for the fact that the authors used the term 'Konstruktion' and not another one; conversely construction can also mean 'creation' in English.

- 3- *Analysis of the design theories underlying the methods.* We analyse the method/theory based on the above-mentioned theoretical framework: a) We characterize the context, the type of products and the design issues of the time and the methods developed by the authors; b) we identify the intention of the authors, and analyse the way they position themselves their contribution by comparison with other works and references; c) Since the distinction between theory and method was not always made by the authors themselves, when necessary, we characterize the design reasoning behind the method, at least the elements of a formal design reasoning that are apparent in the method, when analysed through the lens of C-K theory. d) We characterize the generative and conjunctive power of each method/theory.

In the remaining we will often have to provide some historical elements regarding the contexts and the authors of the design methods, referring to historical works. We consider that these elements might help the non-historian to better understand some of the roots of systematic design. These elements significantly lengthen the paper. We apologize to our expert readers who already know these elements. In each of the following parts, they can directly go two the paragraphs where we answer our research questions for each time period.

3. The method of ratios, a first language in the unknown (Redtenbacher 1850).

Industrial context and presentation of the method of ratios

Pahl and Beitz considered that the first person to write a theory of machine construction was Ferdinand Redtenbacher. The son of an iron merchant, Ferdinand Redtenbacher (1809-1863) studied at the Vienna Polytechnikum. In 1841, after eight years in Zurich, Redtenbacher accepted an invitation from the government of the Grand Duchy of Baden to become professor of mechanics at the newly founded Polytechnikum in Karlsruhe. At that time, the Grand Duchy of

¹ (Redtenbacher 1852a, b, 1858; Redtenbacher 1861; Redtenbacher 1909; Reuleaux and Moll 1862; Reuleaux 1877; Grashof 1875 ; Bach 1924 ; Laudien 1931)

² (Findeneisen 1950 ; Tschochner 1957 ; Hansen 1955, 1960; 1961 ; Bischoff and Hansen 1953 ; Pahl and Beitz 1977; Rodenacker 1970 ; Roth 1982 ; Koller 1998)

³ (Hachette et al. 1808; de Comberousse 1874 ; Poncelet 1827; Morin 1836; 1838 ; Carnot 1824; Dupin 1825; Smeaton 1810; Babbage 1830; Evans 1805)

⁴ (Riedler 1894, 1916; Erkens 1928; Kesselring 1942; Neuhaus 1904; Neuhaus-Tegel 1909; Neuhaus 1910; Engelmeyer 1895; Hansen 1960, 1961; Rodenacker 1970)

⁵ (de Comberousse 1874; Fuchs 1959; Grashof 1866; Keller 1910; Kretzschmann 1865; Plank 1950)

⁶ (Musson and Robinson 1969 ; Peter 1956 ; Poschenrieder 1932 ; Heintzenberg 1950, 1951; Siemens 1961; Trendelenburg 1975; Behringer 1981; Schoen 1990; Wengenroth 1990)

Baden was far from being an industrial power but was nonetheless in strong expansion. The State, particularly in the person of one of its top civil servants, Karl Friedrich Nebenius (1784-1857), launched an aggressive economic development policy, encouraging the building of infrastructures (the Mannheim harbour, the Mannheim-Basel railway) and pushing for the Grand Duchy to join the *Zollverein*, or Customs Union. Nebenius was particularly interested in education, which he saw *as a form of action in favour of industrial growth*. As of 1825, he carried out wide-reaching reforms to education, leading to the creation, in 1832, of a single Polytechnikum grouping the engineering, construction, industrial art and design, commerce and postal engineering schools. The school's aim was to follow the model of the French *École Polytechnique*, by giving mathematical and scientific foundations to practical teaching in industrial art and design. Redtenbacher was hired to create mechanical engineering programmes to meet these demands. As by 1861 Redtenbacher was director of the Polytechnikum and advisor to the court of the Grand Duchy of Baden.

Redtenbacher wrote three types of books: firstly, works on specific types of machinery (turbines, waterwheels, hot-air machines, locomotives); secondly, a machine construction manual (*Resultate für den Maschinenbau*), first published in 1848, with several new editions up to 1875 and which was also translated into French. Thirdly, a work entitled *Principien für den Maschinenbau*, published in 1852, which describes the foundations of 'construction education' (*Konstruktionlehre*) in more theoretical terms. In different forms, the three types of works all covered the method developed by Redtenbacher, the method of ratios.

The method of ratios (*Verhältnismethode*) provided a set of rules to design a new object of a known type, this object being adapted to a specific context/customer. First, it provided all the necessary knowledge on the object type (waterwheel, locomotive, etc. in the form of a set of rules resulting from previous works (by other engineers and scientists) and completed by the author. These rules stemmed from observations of the known objects of this type. They were models of the known objects. They provided relationships between the parts of the machine or between parts and properties of the machine. *They were the 'axioms' that, according to Redtenbacher, had to be shared by all the future machines of the same type*. Second, the method provided designers with a series of steps to be followed to design a new object of this type using the rules. Beginning with a very general brief of the machine ("a new waterwheel for Mr. XXX"), it used a sequence of ratios and abacus to gradually define the object, starting with the main features of the customer's requirements and the parts with the greatest load and finishing with the smallest details of the machine, until a point where it becomes possible to build it.

We can illustrate how the method works by looking at a simple case: designing waterwheels (Redtenbacher 1858). In the first part of the book (Chapters 1 to 3), Redtenbacher made a state of the art review, gradually formulating a series of "equations of effects" relating to the performance and dimensions of waterwheels. He based his arguments on work by Poncelet (Poncelet 1827), Navier and Morin, but also by Smeaton, (although his experiments dated back to 1759) (Smeaton 1810), and also gave the results of his own experiments. As Redtenbacher wrote: "One would have thought that wheels were already widely known and that practical, scientific treatment would no longer be of value today." However, most of the work on the subject only took into account the height of fall, the quantity of water, the speed of water flow and the speed of entry. For example, Smeaton's study used an experimental device to find the height at which the water should hit the wheel to take the most advantage of the movement (see figure below).

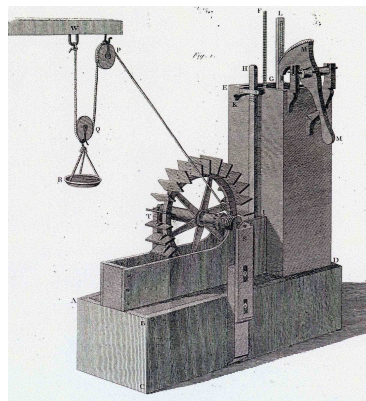

Figure 2: Smeaton's experimental device (1759)

But these studies did not look at any particular features of the wheel or its immediate environment. For example, there were no equations for the size of the wheel, its diameter and width, nothing about choosing blades or buckets, about the number of buckets or their shape, about the depth at which the wheel should plunge into the water, about care to be taken in assembly and in controlling leakage. All these limitations meant that designers could not use the scientific results that had been obtained by then. This is why, still in the first part of his works, Redtenbacher completed the state of the art review with comprehensive models of existing machinery, grouped by main types. Up to this point, Redtenbacher's work was not significantly original. Indeed, it is interesting to note that at the same time, in the US, scientists of the famous Franklin Institute of Philadelphia were attempting to gain knowledge on water wheels and made a series of 'full-scale trials' to get accurate results on water-power efficiency (Sinclair 1974)

Once he had built up these major descriptive models, Redtenbacher went on to the second, most original part of the book: the method of ratios. The method began by following the main stages of a fictitious dialogue between a designer-entrepreneur and a client. According to Redtenbacher, the first question concerned the budget that the client was prepared to devote to the structure as, depending on the answer, the designer could choose between a wooden and a metal wheel, the performance and size equations being very different for the two options. Once the material was chosen, two other questions had to be answered: the height of fall of the water flow and the usable flow (or the expected power generated on the shaft, which comes to the same thing). The designer then used a chart (see graph below) to help choose the best type of wheel depending on the height and the flow. For instance, overshot wheels were suitable for mountain streams, with large heights of fall and low rates of flow, whereas undershot (or Poncelet) wheels were better for water flows in plains, with low heights of fall and high rates of flow. At this stage, the method enabled the designer to choose a class of wheel by evaluating the expected performance, but without having to specify all the dimensions.

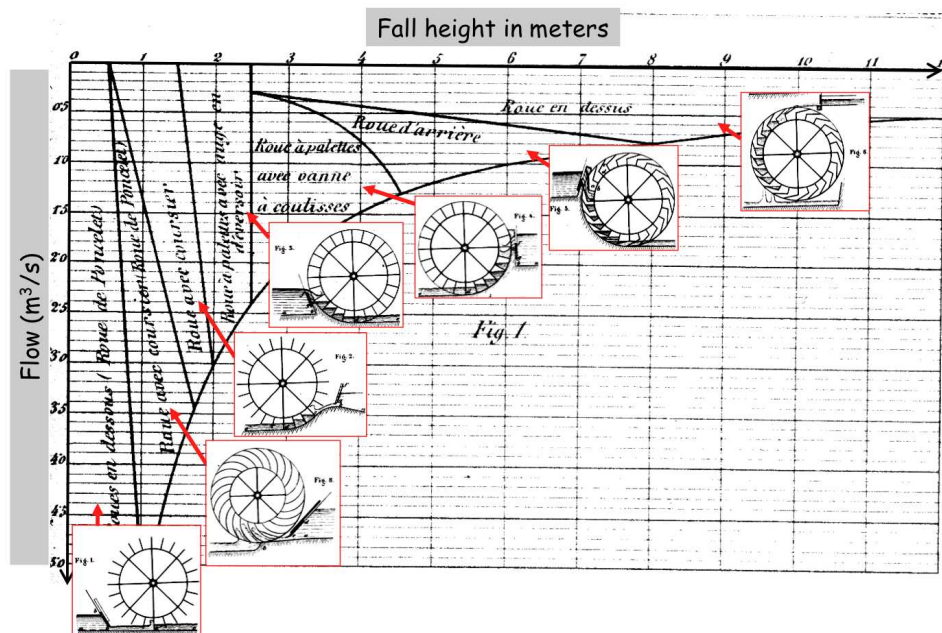

Figure 3: Chart for selecting types of waterwheel depending on conditions of use (original drawing from (Redtenbacher 1861); vignettes are added by the authors; the vignettes are taken from (Redtenbacher 1861))

At that time, this was the most critical part of the reasoning for Redtenbacher, as he had observed that most wheels were poorly adapted to their environment.

The second phase in selecting the dimensions consisted in specifying step by step all the parts of the construction, following methods of calculation or plans (proposed in the book) which were dimensionless and also showed the ratios between the parts. The last part concerned what could be called 'finalisation': Redtenbacher recalled the formulas for theoretical performance and the measurement technique for real performance, inviting designers to compare the performance measured on the construction with the theoretical performance and indicating how to improve the real performance of nearly completed wheels.

In the latter part of the calculation, Redtenbacher noted that his method helped check the performance, "remove imperfections" and "relate all the uncertainties to solid rules."

The method of ratios was not new; Redtenbacher himself recognized that it came from architecture. König pointed out that before Redtenbacher a similar method had been used by English and German mechanics (König 1999) (p. 24). But König also noted that Redtenbacher deserves the credit for introducing the method on such a wide scale, in polytechnic schools and in industrial practices. Up to the 1880s, all the manuals and technical handbooks were based on the method of ratios. Moreover, despite the criticism it received at the end of the century, it was still widely used. There was wide recognition of Redtenbacher's contribution among German engineers in the 19th century, as proved by the many tributes paid to him by professors and students and by the subsequent careers of his assistants. Another symptom was the dedication "to Professor Redtenbacher from one of his admirers", made by Edouard Beugnot, director of the André Köchlin locomotive works in Mulhouse, in a notebook with drawings of construction plans for locomotives. According to Keller who tells the anecdote, Beugnot apparently used Redtenbacher book "*die Gesetze des Lokomotivenbaues*", published just before 1860 (Keller 1910).

Q1: Why did theories and methods of systematic design come about?

Now that the context and the method are presented, we would like to analyse the origins of the method.

1- It is important to underline that Redtenbacher was very close to the industry. In 1833, at the age of 24, he was appointed to the Zurich Polytechnikum as professor of mathematics and geometry. In Zurich, he met the director of the machine construction works Escher-Wyss, Hans Caspar Escher, and his son Albert. A few sources (Henderson 1968; Musson and Robinson 1969 ; Smiles 1874 ; Peter 1956 ; Hoigné 1916) show that with Escher-Wyss, Ferdinand Redtenbacher was in contact with the high technology of the time (Kretzschmann 1865) in a company that sought to imitate or even surpass its competitors in Great Britain. The company's reputation was such that in 1845 the Manchester Guardian wrote that "nowhere in England can one acquire such a good technical education as under Caspar Escher in the Zürich Neumühle" (quoted by Henderson, (Henderson 1968)). At Escher-Wyss, Redtenbacher conducted several series of observations, carried out trials and noted a set of essential indications for the practical functioning of machines. He built up a corpus of studies, recordings, sketches and calculations on the company's different machinery (waterwheels, turbines, land and naval steam engines, etc.). His introductory comments in his books show that he was aware of the limits of designers of his time, who tend to reproduce known objects instead of redesigning customized machines.

2- He proposed a method that was original. He was himself clearly aware of the UK and French alternatives but tried to develop a new one. In the text he wrote for the 1858 book on Karlsruhe {Bader, 1858 #2730}, he explained why it was not possible to follow the English way: "On the continent, we have neither the financial resources nor the wide experience in exercising all the specialities that would enable us to take the path of pure empiricism. We are therefore obliged to replace or endure the lack of money and the limited experience with intelligent strength and scientific unity" (cited by {Fuchs, 1959 #901}).

French engineers, scientists and professors had already shown the same concern to upgrade industry (Dupin 1825). For instance, Jean-Victor Poncelet, a graduate of École Polytechnique, taught an introductory course on industrial mechanics at the École du Génie in Metz (École Mézière, practice school for École Polytechnique) (first published in 1828). Considered that the 'general principle of live forces', or the transmission of work, should dominate in his teaching in order to "spread throughout the industrial class doctrines of indisputable utility that it would be detrimental not to know, making it familiar with notions which, in the past, were almost exclusively shared by a small number of engineers." (Poncelet 1870 ; de Comberousse 1874) The aim was therefore to upgrade industry by making the results of mechanical sciences available to the greatest number of people.

Redtenbacher was aware of this teaching (Keller 1910), but he voluntarily distanced himself from it. It was undoubtedly this sort of class that he had in mind when he wrote the following in his preface to Resultate für den Maschinenbau: "With the principles of mechanics, machines cannot be invented, because to do so, apart from a talent for invention, one also requires precise knowledge of the mechanical process for which the machine is to be used. With the principles of mechanics, sketches of machines cannot be made, because a sense of composition, arrangement and forming is also required. With the principles of mechanics, no machines can be made as this

requires practical knowledge of the materials to be worked and experience in handling tools and auxiliary equipment. With the principles of mechanics, one cannot manage an industrial business, as this requires a strong personality and knowledge of commercial affairs” (in {Redtenbacher, 1852 #917}). The Resultate were translated into French in 1861 (to our knowledge, they were not translated into English). The preface dated 1848 was also translated, almost entirely. However, the above paragraph was not included in the French translation! It was hard not to see, of course, that it was harsh criticism of upgrading through science.

Hence Redtenbacher’s programme was to provide a method that: 1) helped save on experimental learning; 2) not only covered knowledge in mechanical sciences but also mechanical processes and conditions of use, questions of composition, arrangement and forming (ie a truly architectural knowledge of the machine⁷), materials, procedures and tools, commercial questions and even the personality of the designer-entrepreneur!

3- He proposed a method designed to effectively train designers. With this method “after two or three months training, all beginners in machine construction should be capable of constructing each part of a machine to meet given conditions.” According to Redtenbacher, the method was good because it could be taught easily and rapidly and because designers could use it in a large number of situations and find solutions that they knew were not optimal, but which were nonetheless satisfactory. Hence it was not a “speculative” construction. Redtenbacher really aimed to improve design activity.

However, it was not a “descriptive” theory either. The method *did not correspond to established practices*, to say the least. A symptom of this “non-descriptiveness” was that in fact, Redtenbacher’s method was *not* easily accepted. First of all, many people considered this education too theoretical. In addition, certain professors refused to use the method, which they considered to be a dry collection of formulas and tables with no scientific grounding. For example, Kankelwitz, professor at the Stuttgart Polytechnikum, declared to one of his students: “For as long as I am in our school, no one will have the right to use any of Redtenbacher’s books” (Keller 1910). The method was of course widely disseminated despite this, but the resistance proved that it was seen as imposing new forms of action and reasoning that were far removed from the established practices and doctrines.

Q2: the specific features that characterize Redtenbacher’s method: a language of the unknown

What were the specific features of the Redtenbacher’s *Maschinenbau*? C-K formal framework helps to characterize two contributions, that are clearly distinguished in Redtenbacher works: Redtenbacher was very careful, in his classes and his manuals, to separate the part where he built ‘complete theories’ on existing objects (eg, Chapters 1 to 3 on wheels) from the part where he proposed an approach for gradually determining unknown objects.

1) A language of the known: in the ‘first part’ Redtenbacher gathered all the knowledge available on existing objects, coming from scientific experiments as well as practical experience and any other sources. People commenting on Redtenbacher’s works were struck by his pluralism, as he did not choose between different means such as formulas, estimates, calculations, measurements, experiments or simply experience and guesswork. Redtenbacher made great efforts to synthesize and even complete and reorganize this knowledge and to propose models of the known objects. So far, Redtenbacher had provided a set of rules for known objects and these methods are all in K space⁸. This built the initial knowledge base for the designer.

2) A language of the unknown: on the other hand, Redtenbacher also provided a way to make use of this knowledge to work on objects that did not exist yet: in C-K theory, the method deals with the relationship between space C and space K. In the second part of his books, Redtenbacher proposed a list of questions to be answered by designer. The list was highly structured, with three different types of questions (see Figure 4 below):

⁷ The terms employed refer almost explicitly to the terms used by Vitruvius: “Architecture consists in five things, fitness, arrangement, eurhythmy (or proportion), consistency and distribution (or economy)” (Vitruvius 1999).

⁸ Calculations, estimates, and tests can *contribute* to expansions in C but as such they are only K→K operators, and they require complementary K→C operations to make use of the results (or simply to interpret the result as “strange”, as an attribute for a still unknown object).

- 1- Based on an initial concept (eg “a new machine for Mr. xxx”) the first questions aim to guide the dialogue with the customer so that the latter provides relevant, specific types of knowledge (budget, environment of the machine, etc.).
- 2- The ratios themselves gradually help to calculate the critical dimensions of the machine. Step by step, the unknown object becomes more and more defined.
- 3- In the end, the designer is guided in the finalisation phase: he is taught how to measure the real performance of the unfinished wheel, how to calculate the theoretical, expected performance and how to improve the design of the waterwheel to bring it as close as possible to the expected performance.

This sequence has three main features:

- Each question links C and K and helps to sophisticate concepts by making use of knowledge, available in the K-space. It also helps to distinguish the unknown (concept, the unknown waterwheel) and the known (knowledge, known ratios, based on existing objects). It adds attributes step by step, but the unknown object is not confused with an existing one. In this sense, this is the ‘*semantics*’ of the unknown, in contrast to the known.
- The sequence of questions converges towards a final object. There is an order in the sequence, to finally build the unknown object. This is the ‘*syntax*’ of the unknown, to build a new object.
- Even more: at certain critical points, the unknown guides the creation of knowledge (eg. the water wheel for Mr. xxx” leads to explore what is the budget of Mr. xxx and the location of the future wheel)

This sequence of questions hence builds *a complete language of the unknown*, with proper semantics and syntax, making use of the known but clearly distinguished from it. The classical teaching in mechanics inferred that the model in K was sufficient for designing, as if the model in C could be deduced easily from K. What is surprising in Redtenbacher’s method is that *the language of the unknown had a very different structure from that of the object model*. The object model established relationships between the (known) object's attributes, whereas the method of ratios clarified the order in which the attributes that determine the (unknown) object should be added.

This is why it can be said that the theory underlying Redtenbacher’s method was not a theory of existing objects but *a theory for constructing still partially unknown objects using knowns*. This is undoubtedly its main value (see diagram below).

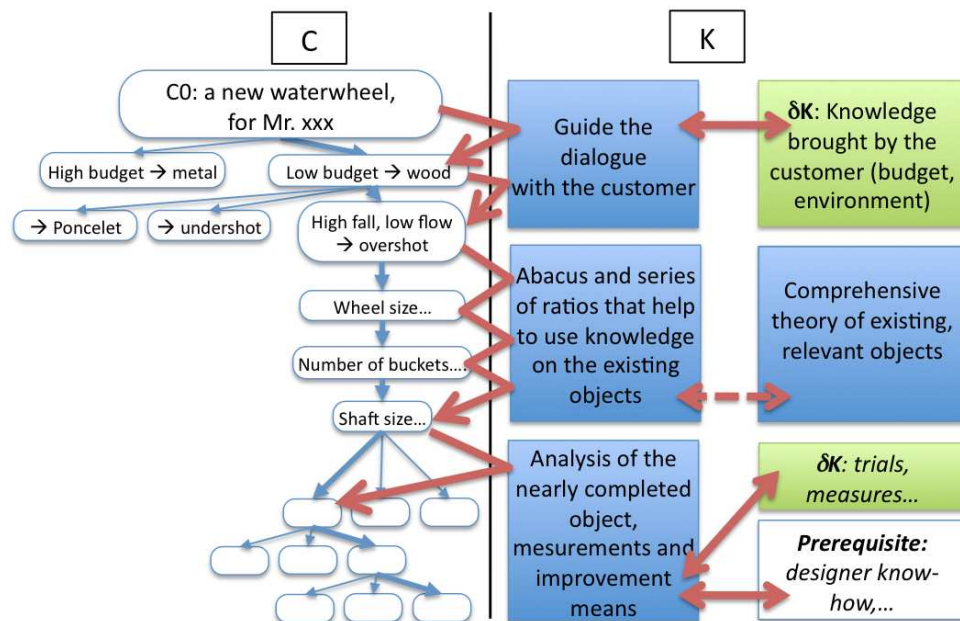

Figure 4: Analysing the method of ratios with C-K design theory

The diagram above shows the contribution of the theory of ratios. The complete theories on existing objects are represented in K; the method also provides a language (in K) that helps to organize the relationship between rules based on known objects (in K) and unknown objects (in C) and organize the steps of reasoning

from a largely unknown object (a new waterwheel adapted to its context) to a finalized waterwheel. The elements provided by the designer and not included in the theory are shown on a white background. “ δK ” boxes indicate the knowledge on existing objects to be acquired by the designer when he follows the method (K-expansions guided by the unknown).

Q3 area of relevance: the relevant uses (generative power) and users (conjunctive power) of these methods

1) Generative power. Which uses did the method target? Redtenbacher made very few claims in respect to innovation: the method served to treat problems in which the designer was already very knowledgeable. Many of the machines covered in his books were not the high technology machines of the time. In 1843, when Watt’s steam engine was already over 60 years old, Redtenbacher was still writing about waterwheels!

But we know how misleading the term ‘innovation’ can be. Far from looking for one single achievement, Redtenbacher was concerned with the challenge of *industrial catch-up*. This is largely testified by his career at Karlsruhe (see in particular {Fuchs, 1959 #901} ; see also {Bader, 1858 #2730}) and more specifically by his work on objects like water wheels. The idea was to provide, as quickly as possible, a cheap, efficient source of energy suited to the needs of the rapidly expanding industries of the time (particularly the textile industry). It was not even a question of making a ‘perfect’ waterwheel (contrary to Poncelet, whose aim was to find a wheel that transmitted the entire momentum of the water flow to the shaft); Redtenbacher sought to provide tools for designing a variety of different wheels *that were well suited to their environments*. He considered that without a method, designers tend to reproduce what they know, building machines that are ill-adapted to their context. They are ‘fixed’: what they know restricts the exploration of the unknown.

More precisely, C-K analysis shows that the method could be used for concepts for which *there was already a complete theory for the associated known objects and a series of ratios built on this complete theory*. A specific method was required for waterwheels, locomotives, etc. and the objects were supposed to be built with the same materials and technical principles, for stable uses, etc. The method is not independent of the object and each unknown object has to be known to a very large extent. These conditions may appear to be restrictive, but they were nonetheless met by numerous classes of objects in the industrial context of the 19th century. The method helped to efficiently create *objects derived from ‘known’ objects and configured to suit specific situations*. This describes the generative power of the method.

2) Conjunctive capacity: the second criterion of relevance, conjunctive capacity (robustness), can be appreciated through the conditions required for the method to be used. How robust was the method for different users? Did the method make strong assumptions or not concerning the designers’ capacities? For all the objects to which it was applicable, Redtenbacher’s method only required the designer to: 1) know how to talk with the client (even then, it codified the dialogue); 2) know how to calculate using ratios and know how to read charts and 3) know how to deal with finalisation (even then, it set the parameters on which to act and the levels of performance to attain). In other words, the method required practically no additional production of knowledge during the process. It should be noted that the designers’ knowledge of existing machines (their level of expertise) was not critical since the method supplied the knowledge if they lacked it; in certain cases, the method even spared the designers from having to acquire complex knowledge. We can therefore say that *Redtenbacher’s method had a high conjunctive capacity*.

Conclusion: the first theory of expansion in aid of industrial development

Our analysis of the birth of the first machine design theory provides answers to our three questions:

1) First of all, we show that the theory was neither a description of designers’ practices at that time (descriptive) nor a purely speculative construction. It can be said that it aimed to *rationalize* design: taking into account the context and the stakes, it proposed, on the basis of an original formal model, a means of very profoundly transforming collective practices.

2) Relying on and extending upon works by theorists in industrial science and mechanics, Redtenbacher built a general theory of rules for existing objects (which was not really original) but then he completed these models by a structured language *for designing unknown objects based on these models* – and this was extremely original. As their ‘phylogenetic’ ancestor, it is vital to all contemporary design theories: with many of them, this far-off forebear shares the concern to *stabilise the knowledge base and to propose an integrated process defining all the stages*

designers should follow to move from unknowns to knowns. It was based on the ‘engineering sciences’ of the time although it clearly distinguished itself from them. This language of the unknown appears as a specific feature of design theories/methods.

3) However, the method of ratios tended to freeze the knowledge base as it did not enable designers to integrate new knowledge and left the users of the method very few intermediate design spaces. Redtenbacher’s parametric design tended to make design automatic, as the only space in which users of the method were still designers was finalisation. Hence the method of ratios had a limited generative capacity and a very good conjunctive capacity.

4. Design theories in 1900s: integrating expansions in knowledge to the detriment of processes?

The continuous debate on design theories since the 1850s reached a climax in the 1890s. The method of ratios was followed by a more complex corpus, in which machine elements played an important role. We shall now examine what this renewed corpus teaches us about design theories and methods.

Industrial context and presentation of the method

At the end of the 19th century the products had changed enormously since Redtenbacher’s times (see {König, 1999 #757 ;Riedler, 1916 #1256 ;Trendelenburg, 1975 #1242 ;Wengenroth, 1990 #869 ;Mauersberger, 1998 #2236}). From the 1860s onwards, machines had to run at high speed, high pressure and high temperatures; rapid steam engines meant that it was vital to explore new, more complex phenomena related to dynamic behaviour. New forms of machine also began to appear, such as bicycles, sewing machines, gas engines, automatic turning machines, linotype printing presses, steam turbines, or electrotechnical machine for telegraph communications or public lighting, etc., all requiring knowledge and design capacities in precision mechanics.

In this new industrial context, the methods used in the Technische Hochschule and their design teaching began to be severely criticised. In the 1890s, the tensions led to what the protagonists themselves called a ‘seven-year war’, between the ‘theorists’ in favour of teaching mechanics with scientific models such as Reuleaux’ cinematic and the ‘practitioners’ who proclaimed themselves ‘anti-mathematics’ and denounced the over-theorisation of teaching that was too far-removed from practical applications.

In this context, some professors developed new methods to teach engineering design, to try, as said by one of them, Carl Bach, “to solve the opposition between theory and practice” {Bach, 1926 #2732}. Wolfgang König considers Carl Bach as one of the best examples of the authors who tried to rebuild Maschinenbau at that time. Contrary to others authors, like Riedler, whose writings were mainly programmatic, Bach presented his views in manuals and education books which, over decades, were recognized as standard works⁹ {König, 1998 #758} (p.73).

What did these views consist in? At that time machine design training programs increased the emphasis on machine elements. The teaching focused on the elements which appeared to be the most *important, always fulfilling the same functions in the machines*. The classical chapters for such classes were machine elements for assembly (nuts and bolts, rivets, etc.); for turning machines (ball bearings, etc.); for the transmission of turning movements from one shaft to another (gear wheels, etc.); for translatory movement, for the transformation of a translatory movement into a turning movement and vice versa, etc. They were often preceded by introductory chapters on the strength of materials.

These subjects were already included in the reference works of Redtenbacher and Reuleaux, but their content had been added to considerably by Bach. In his Machine Elements, contrary to Redtenbacher and Reuleaux, Bach avoided using ‘ratios’ and preferred “*a definition of dimensions taken directly from the active forces*”. In his works, he replaced the figures from the method of ratios with calculations, results from tests or results from companies’ previous works. His book on

⁹ Bach’s Machine elements and its nine new editions, was published thirteen times from 1881 to 1922 and translated into Russian, French and Swedish. Bach’s Elasticity and Resistance (Elasticität und Festigkeit), initially published as the first part of the Machine elements, was published for the first time in 1889 with nine new editions up to 1924.

Strength of Material, entitled *Elasticity and Resistance (Elastizität und Festigkeit)*, distinguished itself from the works of his predecessors by treating the subject as an experimental science and not just a simple application of mechanics. As he declared in the VDI journal in 1889, he wanted to base the proposed laws on experimental results, whilst avoiding any generalisations that were not based on sufficient experimental material and putting the focus on in situ observation of real processes. Among the significant contributions made by Bach, Mauersberger pointed for example to the clear distinction made between elastic and plastic deformations and the study of the different behaviours of several types of materials (cast iron, wrought iron, steels, high alloy steels, light alloys, etc.), for which he analysed the impact of temperature and thermal treatments, tempering and annealing. Quite unusually for that time, he took great care to specify *the scope of validity* of the results {Mauersberger, 1998 #2236}

The books clearly distinguished the knowledge they could give and the knowledge they wouldn't, because it could be better provided through other means. For instance Bach explains: "regarding the fabrication of the machine elements, we just give the necessary indications [...] because a successful course of Maschinenbau made in the interest of the industry requires the young technician to have already fulfilled, if possible, a two-year practical activity in the workshop" {Bach, 1896 #2731}.

The new editions *updated the results on a regular basis*, based on new experiments and remarks sent by professionals (the fifth editions thanked the expert who will make the author aware of imperfections in the book"). These updates also took into account changes in the economic situation. For instance, in the eleventh edition (1913) Bach explained that whereas he had favoured tests with limited structural loads up until then, as this corresponded to the industry's general tendency to prefer long life spans, he now proposed results for greater structural loads as the industrial context lead to more frequent component changes. In the following edition, in 1919, the economic crisis after the First World War led to shortages of materials and therefore to new reductions in structural loads.

Q1: Why new methods, such as new "machine elements", in the 1900s?

What was the aim of Bach's work?

1- Let's first underline that Bach, and more generally the professors of machine construction of this time, were very close to the leading mechanical design firms. Reuleaux was a consultant for Otto and for Mannesmann (seamless tubes), Riedler worked with a number of industrial entrepreneurs, especially Rathenau (whose biography he wrote); Bach worked in industry for a long time and had close relations with Bosch whilst he was a professor; Kesselring worked at Siemens, etc.

They were aware of the design issues of the industry of their time: the rapid changes in products and technologies (new processes, new materials) led to recurrent difficulties (breaking of shafts, wheels, etc.), underlining the fact that the technologies were often not sufficiently under control, particularly in terms of design (errors in dimensions, ill-adapted processes, lack of knowledge on the behaviour of materials, etc.).

2- Bach's also knew the limits of the existing methods: on the one hand, he was a strong opponent of the still very pregnant method of ratios. As is wrote in his memoirs: in 1876, he was managing director of Lausitzer Maschinenfabrik in Bautzen where he organized the development of a new waterwheel business. In a report to VDI, he explains that he couldn't use the ratios established by Redtenbacher because they were no longer adapted to existing materials, components, evaluation criteria, etc. so that he had to carry out a large number of laboratory tests himself {Bach, 1926 #2732}{Mauersberger 1998}.

On the other hand, when the method of ratio disappeared, it was often replaced by a strong division between "practice" and "theory". Bach explains that in the 1870s, several courses in Machine construction were divided into "theoretical teaching of machines" and "practical construction of machines" and this division led to a growing gap between both parts, "in which people from both side threw things that didn't suit them or that they couldn't address with the available means" {Bach, 1926 #2732}.

3- Bach proposes new ways to teach machine construction, following one strong idea {Bach, 1926 #2732}: « between the scientific foundations of an area and the practice, there can't be any opposition, when the scientific foundations are actually what you can expect from them. If one implies with « scientific foundation » the systematic arrangement of all pieces of knowledge that you get on one object, then there can't be any opposition with the actual ratios. At most, there can be something not yet known or not yet clarified, but no opposition. » Hence to face the challenge

of overcoming the tension between theory and praxis, Bach made the hypothesis of a scientific unity of the existing object and looked for a method to provide the relevant knowledge.

To reach this knowledge unity, Bach relied on multiple sources of knowledge. In his books, he combined data coming from scientific experiments and new methods of calculations adapted to complex technical problems. But his books were only the visible part of a large iceberg. Bach recommends to use two other sources of knowledge: in his prefaces to machine elements he strongly advocated education by practical training in the workshop, “not only to know material behaviours, tools and machines, and usual forms of machine design but also, by direct contact and proper cooperation, to learn to assess the workers and to deal with them”; on the other hand he explains in his memoir how strong he fought to create a testing lab at his university.

Hence Bach’s books were actually pieces in a much broader “method” that was truly prescriptive: based on the design issues of his time he proposed a method to improve knowledge and knowledge production on the machine of his time.

Q2: the specific features that characterize the underlying (partial) design theory: integrating different forms of knowledge production

Now that we have clarified the logic of Bach’s method, we characterize it in a design framework.

1) Language of the known: following Bach himself, it appears clearly that his method led to provide the designer with a comprehensive knowledge base with strong properties:

- 1- it was taking into account several types of knowledge (models, scientific experiments, practical experiments, knowledge on materials, processes, tools and even workers...);
- 2- it was up-to-date: the multiple editions of his books provided updated data on materials, models and performance criteria
- 3- it was “expandable”, in the sense that the user was also trained to produce knowledge (or to order knowledge production) in testing laboratories.
- 4- the attention paid to the scope of validity helped to specify the boundaries of the known and the unknown. The designers could ensure that they remained within the known.

This method had the advantage of offering designers an easily activated knowledge base for solving the traditional problems, leaving them free to concentrate on the *critical parts* of the object. Diesel’s enthusiasm for Bach’s machine elements is easy to understand in this respect, when the latter declared: “At the beginning of the 1890s, when I began to build my engine, the method (of ratios) failed completely. Due to the enormous pressure produced in the engine and levels of friction in the sliding parts that had never been seen before, I was obliged to examine as accurately as possible each component’s fatigue and to study the question of the materials themselves. Not even minor details could be left to chance with ratios and safety factors.” In this state of confusion, Diesel discovered the second edition of Bach’s Machine Elements. He was so “enthusiastic” that he decided to abandon his engine and first take the time to read the book from cover to cover. “The time was not wasted because I was then able to construct; the book helped me feel, in every machine component, what was following its course, just like a gymnast, through his exercises, feels how his limbs are tensed, compressed or curved.”

2) Language of the unknown? This method was a powerful means to describe the known. But it offered few solutions for using the rules for unknown objects. In C-K terms, they did not provide guidelines for operators between C and K (see Figure 5 below): strictly speaking, in the C-K framework, the design methods only helped designers add to the initial concept, ‘a new machine’, the attributes (the constraint), “with the known (and most recent) machine elements”. But it did not explain how to make use of them. In this sense, *the methods did not really provide a language of the unknown*; they mainly worked on the K-space, in the same way as French scientists at Ecole Polytechnique or Diderot’s Encyclopaedia; with one major difference: they provided techniques for regularly updating the knowledge base and creating knowledge on known objects.

In a context of growing numbers of rules, the question of languages of the unknown, which Redtenbacher had answered with a parametric model, was addressed once again, but no formal answer was found. Note that this probably explains why the method of ratios was still applied late in the century. At the beginning of the century, construction viewpoints were developed to stabilise languages for the value of the design of unknown objects (Laudien 1931). These constructions viewpoints provided designers with evaluation criteria for combining the elements into a ‘good’ design. For example, simplify the external shape; favour straight lines; prefer a single piece rather than assembling several pieces; build small, etc. However, these construction viewpoints were also languages for the known. They helped to evaluate objects that had already been designed, but were more difficult to use during the design process.

In this period, the only traces of a structured ‘language’ of the design process, ie of the operators enabling designers to link C to K and K to C, were forms of ‘project-based’ education, based on series of exercises given depending on the degree of ‘unknowns’ involved (Engelmeyer 1895) and tools for assessing sketches that helped organize more effective trial and error processes (Kesselring 1942).

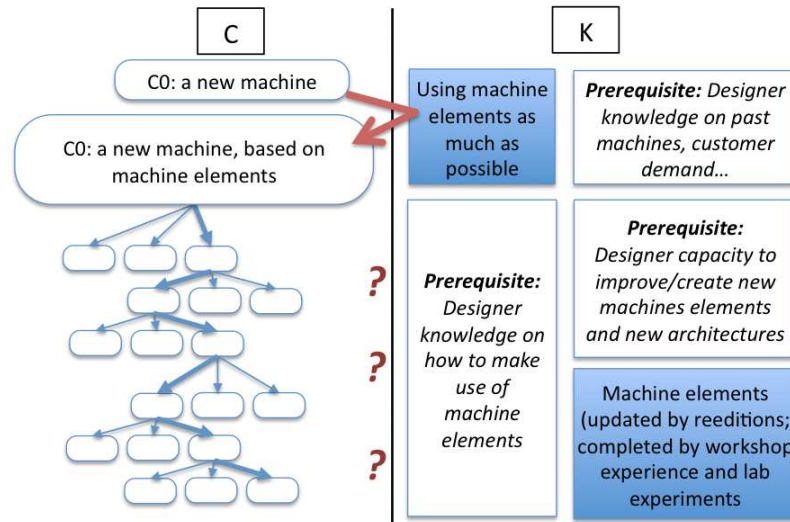

Figure 5 : Elements of design theory available in 1920, interpreted using C-K design theory.

Machine elements and viewpoints appear in K, as knowledge on existing objects. The formal framework proposes little in terms of languages of the unknown. The method doesn't provide a complete language of the unknown to organize the relationship between C and K (see first row in K). The designer has to rely on his own experience to combine machine elements into a machine or to create new machine elements.

Q3: generative and conjunctive capacity – the limits of incomplete languages

1) Generative capacity? Just as Redtenbacher's work did not aim to design innovative machines but to make overall improvements to design capacities, works in the period from 1880 to 1920 essentially aimed to improve robustness in designing wide families of products. These works did not create the new products of the second industrial revolution (electrotechnology, precision mechanics, heat engines, etc.) but contributed to their future development. They favoured the design of products respecting increasingly complex ‘conditions of existence’ (sophisticated, multi-functional criteria, increasing importance of economic criteria, etc.), if not with minimal, at least with controlled design efforts. Hence, they seemingly had high generative capacity.

However, this apparent extension of the space of designable objects had certain limits. We have seen that these methods helped to design objects on *known* machine element models. But they didn't present ways to create machine elements. The machine elements were gradually transformed into norms which imposed themselves on designers. Standards offices were first created in companies (for example, in 1890 at Siemens) and then on a national level (VDI's *Deutsche Normen Ausschuss* started its work in 1917 and gradually became recognized as the national standards body). In the 1950s, Tschochner, professor and engineer, considered that they tended to limit creative imagination (*schöpferische Phantasie*) (Tschochner 1957). The generative capacity of the method was therefore quite limited.

2) Conjunctive capacity: what capacities were required by the designers who were to use the methods? In cases where only elementary components were needed, the designer simply had to know how to choose from a (rich, well-organized) catalogue. In cases when whole machines were to be designed, the methods offered few means for organizing the design reasoning. It proved to be a delicate exercise; a great deal of knowledge had to be added, for the most part produced as the design reasoning emerged. Diesel spent another ten years perfecting his engine after reading Bach (Bryant 1976)! This is explained by the fact that the method helped to avoid some explorations (on machine elements) but gave no advice for designing a whole machine. The design exercises required ‘talented’, ‘experienced’ designers. For ‘new machines’ the methods' conjunctive capacity was therefore weak.

As such talented designers were often lacking and there was no formal framework for effective initial explorations, downstream constraints became dominant and even led to standardisation in the types of machines produced (*Typisierung*), to limit design efforts at the level of the complete machine. The watchword at AEG, as in many other firms, was “invent less, construct more” (*Weniger erfinden, mehr konstruieren*). Hence, as the methods available at the beginning of the 20th century did not cover the whole design process, they had a limited conjunctive capacity, meaning that the ‘average’ designer could not take advantage of their generative capacity.

To conclude: in an attempt to integrate knowledge production into design reasoning, machine elements and construction viewpoints proposed new languages of the known but failed to propose related languages of the unknown. This resulted in limited conjunctive and generative capacity.

5. Systematic design in the 1950s: an effective formal framework for resisting fixation by knowns

In post-war Germany, several methods could be related to ‘systematic design’, ie a systematic design process for constructing new objects based on known ones. Historical works {Heymann, 2005 #2141} have shown that the origin of these methods can be found in the 1950s, in the German Democratic Republic. We will show that it emerged in a context of rationalization of intellectual work and resulted in proposals for a renewed language of the unknown.

Context and methods

The method takes its roots in a company, Carl Zeiss Jena (CZJ), in the GDR in the 1950s. At that time, CZJ, a leading manufacturer in precision mechanics and scientific instruments, was in great need of design rationalization: following twelve years of Nazism and six years of war, the firm was first occupied by the Americans, who sent 146 of the research centre’s researchers to the western zone, and then by the Russians who took apart the machinery and sent it east to Russia. In the years that followed, the available scientists and designers emigrated to the west, or were requisitioned by the Russians. There was a great need to rebuild, but with very limited resources.

The political context was very favourable to rationalization. The GDR launched policies based on technological progress and participative innovation (*Neuererbewegung*). In many places, the methods initiated by the Innovation Movement were poorly disseminated, with the notable exception of the ‘systematic construction’ (*Konstruktionsystematik*) – which underlay the training programmes at Carl Zeiss Jena - developed by the engineers Friedrich Hansen, Werner Bischoff and Arthur Bock, engineers at CZJ and then professors at the newly created Hochschule Elektrotechnik in Ilmenau.

Systematic construction got a large success. At Zeiss, Heymann reports: “For small constructions, the method allows for savings of around 25%; for more complex systems, adjustment times could be reduced from 3 months to 2 weeks” (Rühl 1955). The method was disseminated in the GDR, by the school of Ilmenau and by publications. When researchers began to work on computer-aided design tools in the 1960s, a large part of the research programme Autokont was based on it (Anschütz et al. 1969). The method was also used to organize the relations between research and development (Hansen 1961).

It was also disseminated abroad. Whereas it is generally accepted that flows of knowledge have tended to move, overall, from the west to the east, many German historians believe that systematic construction was one of the few competencies that went from east to west (Heymann 2005): West German researchers like Rodenacker attended seminars in the GDR and ten years later, when Federal Republic of Germany was confronted to an engineering labour crisis, they presented the systematic construction in the seminars organized on ‘the design bottleneck’ (*EngpassKonstruktion*). The notions were further transformed before the reference works on systematic design such as Pahl and Beitz’ manuals were published, but the latter contains many traces of the earlier works. This diffusion was also visible in VDI guidelines (VDI 2222 on engineering design methodology, VDI 2220 on product planning, VDI 2223 on embodiment design, VDI 2221 on the development of technical systems and products) (Motte et al. 2011) and in management techniques (stage-gate, V-cycles, value analysis, house of quality, risk management in projects, etc.).

Systematic construction rests on four essential notions:

1. The **vital core** (*Wesenskern*) of the design exercise, also called the fundamental principle (**Grundprinzip**), which contains all the possible solutions¹⁰;
2. Each solution is a **combination of 'items'** whose individual effect is known;
3. Each solution comprises **errors**, ie **"lacks of every kinds"** to be reduced to a minimum;
4. The solution with the lowest error is the **optimal solution**.

The process follows a series of very precise stages (see diagram below (Hansen 1955)):

1. In a given 'design task' (*Aufgabe*), preliminary thinking helps determine the *fundamental principle* formulated in a few clear sentences. Note that this 'fundamental principle' is slightly different from the 'basic principle' put forward in Pahl & Beitz: it is not the identification of a solution principle (see below) but rather an abstract, general statement of the design task that does not preclude any possible solutions¹¹. The first stage encourages designers to distinguish between, i) the specifications to be met whatever the circumstances; ii) wishes to be taken into account on an optional basis, possibly with extra costs and iii) objectives to be met as part of overall development, but not necessarily during the design exercise underway.
2. The 'working principles' (*Arbeitsprinzipien*) are then elaborated by *combining elements of solutions* including characteristic criteria (*Konstruktionsgesichtspunkte* or construction viewpoints). These working principles have three main characteristics: 1) they comprise elements of solutions, ie physical systems or particular sub-functions, especially those required for any solution; 2) the elements of solutions are completed by characteristic features (*Merkmale*, value attributes) that serve to determine, to the greatest possible extent, the characteristics such as materials, processes, forms, energy sources, etc. and 3) working principles must also specify the forms of matching (*Abhängigkeitsverhältnis*, the relation of dependency) that link the functional elements to one another. The authors insisted on the fact that state-of-the-art reviews should be done as of the second stage.
3. By analysing errors, the designers identify improved working principles (*verbesserte Arbeitsprinzipien*).
4. They then define all the residual parameters, leading to a production project (*Herstellunsunterlagen*)

¹⁰ This 'set-theoretic' formula was in fact adopted by Anschütz et al. in their presentation of the theory for the research programme Autokont in the 1960s at Ilmenau (Anschütz et al. 1969). Our grateful thanks to Torsten Erbe, researcher at Ilmenau University, who found this document in the university's archives.

¹¹ We thank an anonymous reviewer for this very insightful remark.

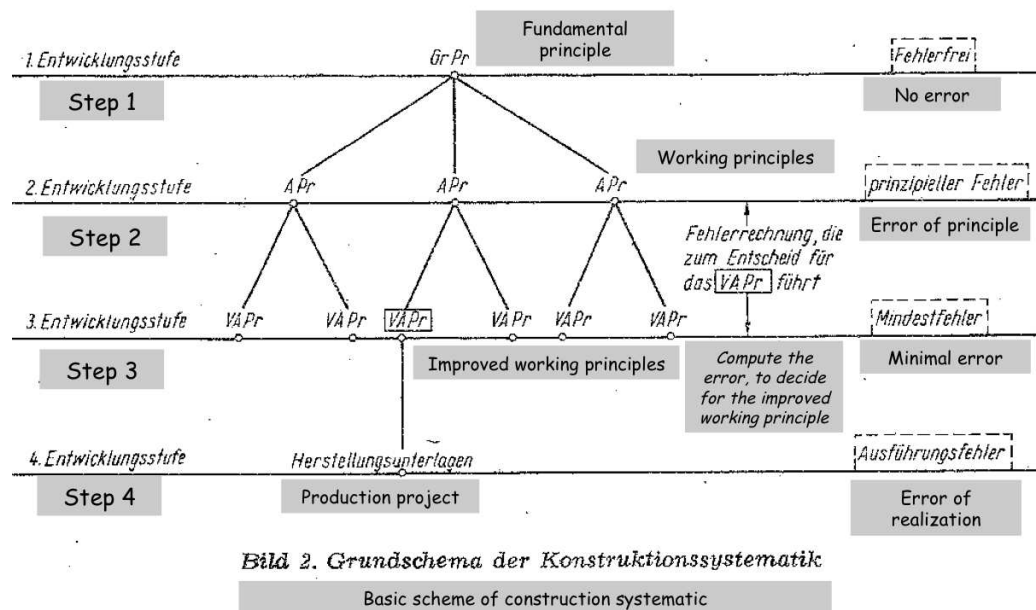

Figure 6: Basic diagram and process for systematic design (Hansen 1955). (The second representation looks surprisingly like a C-tree in C-K theory)

Q1: Why did theories and methods of systematic design come about? Rationalization of creative work

Just as Redtenbacher did not follow the French way of rationalizing design, Hansen did not follow the classical paths proposed in his time. In a company designing and manufacturing precision devices, finalisation is a critical, often very costly activity, involving long phases of adjustment at the end of production stages. Hansen and his colleagues were looking for a method of rapid finalisation. Traditional solutions consisted in better knowledge management and more norms in order to involve less qualified labour, in providing better working conditions and better tools to improve concentration and task efficiency. But Hansen and his colleagues aimed at “working on the possibility of *influencing the cognitive activity itself* to ensure that it is not cluttered by going in pointless directions and that any research which does not fit in with a well-defined mode of reasoning is avoided” (Hansen 1955).

As they explain, they did not develop the method by observing talented designers, who were often unable to explain what they did and sometimes learnt unconsciously. They worked on the thought process and developed “essential rules of construction in order to deduce from them very generally valid guiding principles for the creative work of design” (Hansen 1955). They drew up a comprehensive system of construction (*geschlossene Systematik*) that not only clarified the entire scope of the activity of construction and its methods, but also made it possible to simultaneously rationalize the activity (Bischoff and Hansen 1953) (quoted by (Heymann 2005), p. 155).

Hence this early form of systematic design i) was more than a ‘mere’ description of practices but ii) was not a speculative theoretical proposal. It aimed to create new forms of collective design action.

Q2: the specific features that characterize the underlying design theory: rules and languages to overcome ‘fixation effects’ in the unknown

How does the method deal with the unknown and the known? The reasoning is based on kind of ‘regression’: for an unknown object Y , the aim is to find the variables X_i (the known items) and the associated regression model $f(X_i)$ which provide the best behaviour prediction for the object $Y=f(X_i) + \epsilon$, in the sense of minimising the error function $\epsilon = Y-f(X_i)$. The aim is to find the function $f(X_i)$, based on *known* items and *known* combinations, that *determines* the *unknown* object to the greatest possible extent.

The process to get a good “regression” of the unknown on to the known can be analysed as interactions between the C space and the K space. We represent this sequence in the C-K graph below (Figure 7). This helps identify the following critical operators:

1. **K→C**: in this initial phase, the “task” is transformed into a **Grundprinzip**, or fundamental principle. The authors particularly stressed its importance: “Although such and such a solution has already emerged, it is important to clarify a fundamental principle. This step towards the abstract is needed *to help find possibilities for new outputs, despite a lack of experience*”, p. 10 (Hansen 1955). The “fundamental principle” appears as the concept behind the task: whereas the designer might be tempted to directly use the “known” to “solve” the task, the identification of the fundamental principle leads to identify the “unknown” hidden in the task (see in particular the example given by Hansen in {Hansen, 1960 #2286}, p. 46)
2. **K→K and C→K**: there are many situations in which the designer is supposed to acquire or create relevant knowledge: regarding the customer and the regulations (first stage), state of the art review (second stage), computations, trials and evaluation (third stage), etc. This knowledge expansion is strongly monitored with two principles:
 - a. Use the unknown to explore broadly: the state of the art review should not be done too early; it should only be done after the designer has proposed some working principles for his fundamental principle, since identifying a variety of alternatives improves the ability to find ‘gaps’ in the reporting of state of the art reviews and known solutions {Hansen, 1960 #2286}. In C-K terms: the designer should favor C→K operators instead of K→K ones. The exploration of K is driven by C.
 - b. Knowledge acquisition shouldn’t reduce explorations: if the state of the art review is done too early this encourages designers to follow paths which, although they seem promising, may prevent them from exploring potentially even better solutions and put an end to the possibility of constant progress.
3. **There is a general logic in the sequence of operators**. The authors underlined that the designers should **avoid adding properties too quickly to the unknown object at each stage**. Hence, the aim of the fundamental principle is to prevent designers from running to the drawing board as soon as the design exercise is launched. The working principles (*Arbeitsprinzip*) (end of stage 2) can be defined using rough hand sketches only and do not require detailed technical drawings. The second stage, which is essentially physico-mathematic, should not be restricted either by considerations relating to materials. The unknowns must be reduced step by step, balancing two forces: avoid fixing the object too early; but also ensure that the process helps to reduce the ‘error’, ie that it still reduces the unknowns from one step to the next.
 This sequence corresponds to a general treatment of tolerances: the method precisely accounts for the *indeterminacy* left by the machine elements in the upstream stages, indeterminacy that had led to rigid types and the renewal of ill-adapted solutions and costly finalisation processes; interdependencies between the elements must not left to the end. They determine the end quality and the time required for finalisation, not only for the geometrical performances but also for optical, signal transmission, tension and / or intensity, temperature performances, etc.

This analysis helps to identify a language of the known, made of knowledge on customer requirements, value attributes, solutions elements, structural relationships...

Hansen and his co-authors addressed the question already raised by Redtenbacher regarding the language to be used for working in the unknown. They replaced the idea of ratios with a new, sophisticated process. This language of the unknown comprises *semantics*: 1) at the ‘fundamental principle’ stage, the unknown object should be described by reference to the required functionalities, their value and feasibility, 2) at the ‘working principle’ stage, the unknown object should be described by reference to the state of the art; 3) at the ‘improved working principle’ stage, the unknown object is described in terms of the means of reducing residual errors. This language also comprises a kind of *syntax*: the sentences in the language of the unknown are supposed to follow the same strict sequence of types of attributes and the global coherence of the sentence is measured (and improved) through the error value.

Hence Hansen and his colleagues proposed an enriched language of the unknown, just as Redenbacher did on the products of his time; but they also proposed a very original approach to the known. Instead of having ‘complete theories’ in the knowledge base (as in the ratio method), designers only had types of knowledge which they had to complete for themselves. With systematic construction, the knowledge space was not given at the start but *was built up gradually and could be revised from one design to the next* (see summary diagram below).

Today, there are many versions and variants of systematic design, building a heterogenous corpus of methods, some of which are occasionally contradictory. It is beyond the scope of this paper to compare these methods. Our work suggests that all these theories and methods of systematic design share the idea of the existence of stable ‘systematics of design’, ie a stable, structured set of rules to make use of knowledge or to acquire knowledge to design an unknown object. These rules are not the rules that bind attributes of known objects (in K), but are rules for reasoning on unknown objects (from C to K and from K to C).

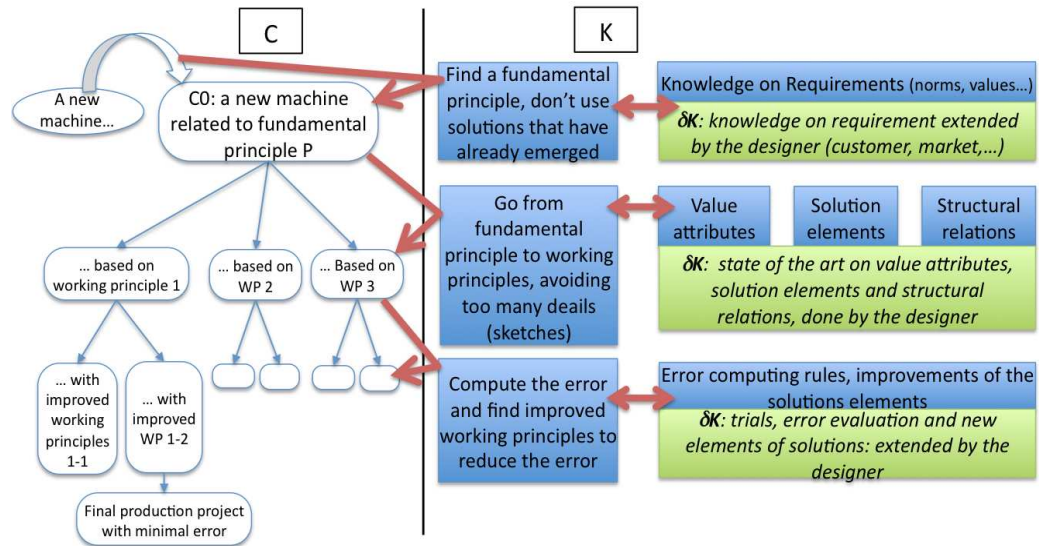

Figure 7: Systematic design interpreted with C-K design theory. The language of the unknown appears in the middle, in K, , ie the operators to link reasoning on the unknown object to knowledge (available knowledge or knowledge to be produced). This language organizes the relationship between C and K ($C \rightarrow K$, $K \rightarrow C$ and $K \rightarrow K$) operators. It also ensures the global coherence of the final sentence in the unknown (sequence of attributes, error reduction).

Q3: generative and conjunctive capacity of the method.

1) Generative capacity: the method is independent of objects. Contrary to the method of ratios which required knowledge of the specific ratios for each class of object, the construction systematic can be used as soon as the designer has value attributes, elements of solutions and the relations of dependency between the elements. The generativity is greatly increased: 1) This explains why the method was adopted in a range of very different fields, such as the automobile, IT, pharmaceuticals, the building and microelectronics industries (see for instance (Dasgupta 1991)). 2) The method enables the acquisition and creation of knowledge, as a resource in the design process; whereas the method of ratios was based on a stabilized model of the objects, Hansen and his colleagues proposed a method to create an ad hoc models of the known objects, built in relation to the design process in the unknown.

It is surprising to note how much the method consisted in resisting what contemporary psychologists have called the ‘fixation effect’ (Jansson and Smith 1991 ; Ward et al. 1999), ie the attraction to what is known, to the detriment of wider exploration of the unknown. The method helped overcome the fixation effect in terms of knowledge, by organizing the times when designers should look for knowledge without being curbed by it.

2) Conjunctive capacity: what are the prerequisites to use the method? The method recommended that knowledge should be created during the process, thereby implying that the designer should have the capacities to do so. This generalised the laboratory and research approach introduced by machine elements. The production of knowledge is tightly controlled and is only authorised at certain stages; in each case, the nature of the knowledge to be gathered is clearly specified. The authors also recommended the introduction of forms of capitalisation so that the knowledge could be re-used in subsequent designs and there would gradually be less need to produce knowledge. The method implies that the designers have a capacity to produce knowledge, but it also rigorously prescribes and controls the use of this ‘licence’. This change also corresponded to changes in the

potential users of the method who, a century after Redtenbacher, had become competent in managing research work.

Similar to Redtenbacher's method of ratios, the aim of the method was not one-off innovation but the overall efficiency of design capacities. It sought to extend the generative capacity as much as possible but without losing too much in terms of conjunctive capacity. The result was a design method that enabled innovation using a system of very varied rules (very general conditions regarding the system of rules) and allowed for the accumulation of new rules.

The analysis also helps identify the limits: the system of rules must include the construction viewpoints, the elements of solutions (technical principles), knowledge of the relations between the entities (knowledge of architecture) and of the means of assessing missing items (errors) at all times. A system of rules of this sort is not always available. It is only possible to accumulate knowledge when the new knowledge is compatible with the previous knowledge. If incompatible knowledge emerges, the theory does not say how to make it compatible.

6. Conclusion: theories of controlled expansion based on languages of the unknown

Without going into details about the stages that led to the different formulations of systematic design in Germany at the end of the 20th century (see the comprehensive study by Matthias Heymann (Heymann 2005)), a few key points from recent history are worth underlining:

- In the decades following its development by Rodenacker, Roth, Koller, Pahl and Beitz and later Hubka and Eder, the set of theories of methods of systematic design became widely used in the manuals, particularly in the Anglo-Saxon world once Pahl and Beitz' work had been translated by Ken Wallace.
- It gave rise to a certain number of debates. One was led by Albert Leyer. In the 1960s and 70s and up to the 1983 International Conference on Engineering Design, Leyer, who was considered a design genius, criticized the logic of the 'scientisation' of the construction methods to the detriment of creativity. The debate does not seem to have been really clarified during this period: the systematic design manuals soon integrated 'creativity techniques' (see the successive editions of Pahl and Beitz' works) and both Pahl and Ehrlenspiel considered that that was sufficient to cater for Leyer's concern that creativity should be taken into account.
- In the 1980s, several research programmes carried out empirical studies of designers, often in partnership with specialists in cognitive psychology. The aim of these programmes (in particular the one made by Pahl, Ehrlenspiel and Dörner and financed by the German research organization DFG) was to "observe and describe the design processes with the methods and concepts used in cognitive psychology and empirical psychology, with a view to deducing *the foundations of a descriptive theory of design processes*" (Ehrlenspiel and Dörner, 29 August 1985, quoted by Matthias Heymann, p. 460). In practice, these studies did not have an impact on design theories, as confirmed by Matthias Heymann: "They provided a great deal of knowledge concerning the complexity of design processes; this knowledge tended to stress the difficulties involved in establishing a general theory of design rather than favour such a theory" (p. 477).
- The empirical studies often revealed that the designers only scarcely used formal frameworks explicitly. The famous author of a product development manual, Ehrlenspiel (Ehrlenspiel 1995), claimed that design reasoning is to a great extent unconscious. This raises the question of whether this is not due to the fact that the theory is deeply rooted in the organizations, particularly the product development organizations described by Ehrlenspiel. Today, the formal framework of systematic design is so deeply embedded that the designers are mere cogs in the organization, who no longer even have an overall view or understanding of it, and in fact no longer need to.
- The question of the languages of the known and the unknown came back onto the agenda in the 2000s, at the same time as renewed interest in design theories (in particular the C-K

theory which served as an analytical tool in this article). In 2008, a new Special Interest Group on design theories was created under the auspices of the Design Society.

At the end of this journey through the history of rule-based design, the following table presents a summary of the main characteristics of the methods and theories we have analysed.

Table 1: design theories and methods at three historical moments in the development of German systematic design

	Method of ratios (1840-...)	Machine elements, (1880-...)	Systematic construction (1950-...)
Industrial context	Known types of products (mechanical machines); rationalization to transform firms	New types of products; adapting to transformations in firms	Known types of products (precision machines); rationalization of intellectual work in firms
(Q1) Descriptive aspects:	Not descriptive: critical of existing practices (reproduce instead of designing)	Not descriptive: critical of ratio-based practices.	Not descriptive: aware of the issues raised by late finalisation; aware of the difficulties in describing "good practices"
(Q1) Action-oriented aspects:	Support German industrial catch-up, help designers to build customized machines.	Provide new building blocks to help use up-to-date components and materials	Reorganize design departments for improved product performance
(Q2) Language of the unknown	Ratios to link the unknown to the known and ensure the coherence of the emerging new object	No	Clearly distinguished semantic levels to relate the unknown to the known; coherence of the sentence evaluated by the "error".
(Q2) Language of the known	Complete theory of certain classes of objects	Construction viewpoints, machine elements, description of new objects, materials, processes, etc.	Value attributes, elements of solutions, structural relations, etc.
(Q3) Generative capacity	Strong generative capacity: All the situations for which there is a 'complete' theory of objects and a sequence of relations	In principle, high generative capacity: all design situations using known machine elements. In practice, weak generative capacity: design situations based on machine 'types'.	Strong generative capacity: All the situations for which there are design viewpoints, technical principles, knowledge of architecture – independent of objects.
(Q3) Conjunctive capacity prerequisites for using the method	Strong conjunctive capacity: Required capacities: 1) speak with the client, following a protocol laid down in the method 2) calculate using the ratios 3) finalise using the elements indicated in the method	High conjunctive capacity for downstream stages (design using a known machine by optimising the machine elements); Weak conjunctive capacity for the upstream stages (design of complete machines using known elements)	Strong conjunctive capacity: Required capacities: identify the fundamental principle, draw up the technical principles, produce the required knowledge, evaluate early on in the process.

Going back to our initial questions, we can propose the following conclusions:

- 1) Q1: Design theories and methods did not originate from either purely formal research or from analytical studies of designers' practices. They corresponded to efforts to rationalise the design activity in very precise historical periods (industrial catch-up in Germany after the first industrial revolution; accompanying the second industrial revolution; rationalising intellectual work in GDR in the post-war period). Recent history (1980s) illustrates, *a contrario*, the limited theoretical contribution of approaches aimed at producing a 'descriptive' theory of the design process.
- 2) Q2: *These theories did not simply consist of modelling existing objects (like the classical engineering sciences) but are formal frameworks to guide the elaboration of still unknown objects with the help of known objects.* The theoretical work concerned ways of describing unknown objects (languages of the unknown) using knowledge of existing objects (language of the known). The question answered by these theories could be formulated as follows: how could one (or several) language(s) be stabilised for objects that did not yet exist, in relation to the knowledge available or which could be produced

by science at that time? However, we saw cases (eg the machine elements method) where this language was not fully elaborated.

- 3) Q3: These formal frameworks did not seek to cater for one-off innovation, but for the efficiency of design capacities. They can be analysed according to the design situations they cover (generative capacity) and the capacities required by their users (conjunctive capacity). Historically, the methods tend to increase generative capacities while maintaining conjunctive capacity.

These conclusions were obtained at three historical moments in one country. It would be interesting to discuss these conclusions further on longer one, to understand better the dynamic of development of design methods and theories.

These conclusions leave open the question of the impact of these theories on industrial growth and economic development. For instance, with Redtenbacher, can we see the beginnings of the industrial success seen in Germany in the second half of the 19th century and the emergence of the present-day major corporation with its engineering and design department?

We have also focused on design methods and theories developed in Germany. They could characterize them by the efforts made to find languages of the unknown and to understand their relations with the languages of the known. Still there are other design traditions. Simon, who heralded the sciences of the artificial (Simon 1969), is one example of a more American stream which, using formal decision-making frameworks, focused less on the languages of the known and the unknown than on the operators that help circulate between the known and the unknown. It seems to be a different tradition that would undoubtedly be worth exploring in more detail.

7. Bibliography

- Anschütz F, Fritsch M, Höhne G, Langbein P, Mehlberg H, Otte V (1969) Beiträge zum konstruktiven Entwicklungsprozess. Ilmenau
- Babbage C (1830) Reflections on the Decline of Science in England and Some of its Causes. B. Fellowes, London
- Bach Cv (1924) Die Maschinen-Elemente, ihre Berechnung und Konstruktion : Mit Rücks. auf d. neueren Versuche 12. verm. Aufl. edn. Kröner, Leipzig
- Behringer P (1981) Ingenieure und Techniker. Technische Angestellte in Grossbritannien im späten 19. und frühen 20. Jahrhundert. In: Kocka J (ed) Angestellte im europäischen Vergleich. Die Herausbildung angestellter Mittelschichten seit dem späten 19. Jahrhundert (Geschichte und Gesellschaft, Zeitschrift für historische Sozialwissenschaft, Sonderheft 7). Göttingen, pp 74-93
- Bischoff W, Hansen F (1953) Rationelles Konstruieren. Ein Beitrag zur wissenschaftlichen Systematik und zur Rationalisierung der schöpferischen Ingenieurarbeit. VEB Verlag Technik, Berlin
- Bryant L (1976) The Development of the Diesel Engine. Technology and Culture 17 (3):432-446.
- Carnot S (1824) Réflexions sur la puissance motrice du feu et sur les machines propres à développer cette puissance. nouvelle édition de 1990 aux éditions Jacques Gabay, Sceaux. edn. Bachelier, Paris
- Dasgupta S (1991) Design Theory and Computer Science, Processes and Methodology of Computer Systems Design. Cambridge Tracts in Theoretical Computer Science, n°15. Cambridge University Press, Cambridge
- de Comberousse C (1874) Notice sur l'introduction à la mécanique industrielle et sur le cours de mécanique appliquée aux machines de J.-V. Poncelet. Nouvelles Annales de Mathématiques 13 (2):5-16.

- Dienel H-L (1993) Der Münchner Weg im Theorie-Praxis-Streit um die Emanzipation des wissenschaftlichen Maschinenbaus. In: Wegenroth U (ed) die technische Universität München. München, pp 87-115
- Dupin C (1825) Géométrie et mécanique des arts et métiers et des beaux-arts. Cours normal à l'usage des Artistes et des Ouvriers, des Sous-Chefs et des Chefs d'ateliers et de manufactures, vol 1 à 3. Bachelier, Paris
- Ehrlenspiel K (1995) Intégrénte Produktentwicklung. Methoden für Prozessorganisation, Produkterstellung und Konstruktion. Carl Hanser Verlag, München, Wien
- Engelmeyer PKv (1895) Was ist eine Erfindung? Civilingenieur 41:282-300.
- Erkens A (1928) Beiträge zur Konstrukteurerziehung. Zeitschrift des Vereines deutscher Ingenieure 72 (1, 7. Jan 1928):pp. 17-21.
- Evans O (1805) The Abortion of the Young Steam Engineer's Guide. Printed for for the author by Fry and Krammerer, Philadelphia
- Findeneisen F (1950) Neuzeitliche Maschinenelemente. Schweizer Druck- und Verlaghaus AG, Zürich
- Finger S, Dixon JR (1989) A Review of Research in Mechanical Engineering Design. Research in Engineering Design 1:51-67 (part I) and 121-137 (Part II).
- Fuchs WP (1959) Die geschichtlich Gestalt Ferdinand Redtenbachers. Zeitschrift für die Geschichte des Oberrheins 107:205-222.
- Grashof F (1866) Redtenbacher's Vorlesungen zur wissenschaftlichen Ausbildung des Maschinenbaues. In: Bassermann (ed) Fest-Rede zur Enthüllungs-Feier des Denkmals Ferdinand Redtenbacher's, 1866.
- Grashof F (1875) Theoretische Maschinenlehre. Voss, Leipzig
- Hachette, Lanz, Betancourt (1808) Programme du cours élémentaire des machines suivi de essai sur la composition des machines. Ecole Impériale Polytechnique, Paris
- Hansen F (1955) Konstruktionssystematik, eine Arbeitsweise für fortschrittliche Konstrukteure. VEB Verlag Technik, Berlin
- Hansen F (1960) Konstruktionssystematik, ein neuer Weg zur Ingenieurziehung. Feingerätetechnik 1960:44-51.
- Hansen F (1961) Grenzen und Wirkungsbereich der Konstruktionssystematik bei Forschungs- und Entwicklungsaufgabe. Feingerätetechnik 1961 (10):452-460.
- Hatchuel A, Le Masson P, Reich Y, Weil B (2011) A systematic approach to design theories using generativeness and robustness. In: International Conference on Engineering Design, ICED11, Technical University of Denmark, 2011. p 12
- Hatchuel A, Weil B (2003) A new approach to innovative design: an introduction to C-K theory. In: ICED'03, August 2003, Stockholm, Sweden, 2003. p 14
- Hatchuel A, Weil B (2009) C-K design theory: an advanced formulation. Research in Engineering Design 19:181-192.
- Heintzenberg F (1950) Von der Werkstatt zur Fabrik. Technikgeschichte 29:121-131.
- Heintzenberg F (1951) Friedrich von Hefner-Alteneck. Abhandlungen und Berichte des deutschen Museums 19 (2):3-35.
- Henderson WO (1968) Industrial Britain under the Regency, 1814-1818. The Diaries of Escher, Bodmer, May and de Gallois 1814-18. Economic History. Routledge,

- Heymann M (2005) "Kunst" und Wissenschaft in der Technik des 20. Jahrhunderts. Zur Geschichte der Konstruktionswissenschaft. Chronos Verlag, Zürich
- Hoigné FH (1916) Gründung und Entwicklung der Spinnerei und Maschinenfabrik Escher-Wyss & Cie, 1805-1859. Zürich, Zürich
- Jansson DG, Smith SM (1991) Design Fixation. Design Studies 12 (1):3-11.
- Kazakçi A, Hatchuel A, Weil B (2008) A Model of C-K Design Theory based on Term Logic: A Formal C-K Background for a Class of Design Assistants. Paper presented at the International Design Conference - Design 2008, Dubrovnik, Croatia, May 19-22,
- Keller K (1910) Zum Gedächtnis Redtenbachers. Bayerisches Industrie- und Gewerbeblatt 96 (36 & 37):351-355 & 363-367.
- Kesselring F (1942) Die "starke" Konstruktion, Gedanken zu einer Gestaltungslehre. Zeitschrift des Vereines deutscher Ingenieure 86 (21/22 30. Mai 1942 und 49/50 12. Dez. 1942):pp. 321-330 und 749-752.
- Koller R (1998) Konstruktionslehre für den Maschinenbau. Grundlagen zur Neu- und Weiterentwicklung technischer Produkte mit Beispielen. 4., neubearbeitete und erweiterte Auflage. edn. Springer, Berlin
- König W (1999) Künstler und Strichezieher. Konstruktions- und Technikkulturen im deutschen, britischen, amerikanischen und französischen Maschinenbau zwischen 1850 und 1930, vol 1287. Suhrkamp Taschenbuch Wissenschaft. Suhrkamp Verlag, Frankfurt am Main
- Kretschmann E (1865) Ferdinand Redtenbacher. Zeitschrift des Vereines deutscher Ingenieure 9:246-262.
- Laudien K (1931) Maschinenelemente. Dr. Max Junecke Verlagsbuchhandlung, Leipzig
- Le Masson P, Weil B (2010) Aux sources de la R&D : genèse des théories de la conception réglée en Allemagne (1840-1960). Entreprises et histoire 2010 (1):11-50.
- Mauersberger K (1998) Die "Maschinen-Elemente Carl von Bachs - ein Standardwerk des Maschinenbaus. In: Naumann F (ed) Carl Justus von Bach (1847-1931) - Pionier-Gestalter-Forscher-Lehrer-Visionär. Verlag Konrad Wittwer GmbH, Stuttgart, pp 155-168
- Monge G (1799) Géométrie descriptive, leçons données aux écoles normales, l'an 3 de la république. Baudouin, Paris
- Morin A (1836) Expériences sur les roues hydrauliques à aubes planes et sur les roues hydrauliques à augets Madame Thiel, Metz
- Morin A (1838) Aide-mémoire de mécanique pratique à l'usage des officiers d'artillerie et des ingénieurs civils et militaires. Madame Thiel, Metz
- Motte D, Björnemo R, Yannou B (2011) On the interaction between engineering design and the development process models - part 1: elaborations on the generally accepted process models. In: Chakrabarti A (ed) Research into Design - Supporting Sustainable Product Development. Research Publishing, Indian Institute of Science, Bangalore, India,
- Musson AE, Robinson E (1969) Science and Technology in the industrial revolution. Manchester UNiversity Press, Manchester
- Neuhaus FA (1904) Der Einfluss des technischen Bureaus auf die Fabrikation. Zeitschrift des Vereines deutscher Ingenieure 48 (33):1221-1225.
- Neuhaus FA (1910) Technische Erfordernisse für Massenfabrikation. Technik und Wirtschaft, Monatsschrift des VDI 3 (10):577-597 & 649-660.

- Neuhaus-Tegel F (1909) Wirtschaftliches Denken und konstruktive Tätigkeit. Werkstattstechnik Juni 1909:293-302.
- Pahl G, Beitz W (1977) Konstruktionslehre (English title: engineering design) (trans: Arnold Pomerans KW). Springer Verlag, English edition: The Design Council, Heidelberg, English edition: London
- Peter C (1956) Hans-Caspar Escher (1775-1859). In: Studien Vfw (ed) Schweizer Pioniere der Wirtschaft und Technik, vol 6. Wetzikon, Zürich, pp 9-30
- Plank R (1950) Fakultät für Maschinenwesen "die Abteilung für Maschinenbau". Die technische Hochschule Fridericiana Karlsruhe, Festschrift zur 125-Jahrfeier:222-226.
- Poncelet J-V (1827) Mémoire sur les roues hydrauliques à aubes courbes mues par -dessous, suivi d'expériences sur les effets mécaniques de ces roues, nouvelle édition revue et corrigée et augmentée d'un second mémoire sur des expériences en grand relatives à la nouvelle roue contenant une instruction pratique sur la manière de procéder à son établissement. 2ème édition edn. Thiel, Metz
- Poncelet J-V (1870) Introduction à la mécanique industrielle physique ou expérimentale. 3ème édition edn. Publié par M. Kretz chez Gauthier-Villars, Paris
- Poschenrieder P (1932) Erinnerungen aus der Werdezeit der Elektrotechnik. Geschichtliche Einzeldarstellungen aus der Elektrotechnik 3:89-125.
- Redtenbacher F (1852a) Prinzipien der Mechanik und des Maschinenbaus. Bassermann, Mannheim
- Redtenbacher F (1852b) Resultate für den Maschinenbau. 2ème édition edn. Friedrich Bassermann,
- Redtenbacher F (1858) Theorie und Bau der Wasser-Räder. 2ème édition (1ère édition 1846) edn. Bassermann, Mannheim
- Redtenbacher F (1861) Résultats scientifiques et pratiques destinés à la construction des machines. Traduction française à partir de la quatrième édition allemande de l'ouvrage "Resultate für den Maschinenbau" (1848) edn. F. Bassermann (Mannheim), E. Lacroix (Paris), Mannheim, Paris
- Redtenbacher F (1909) Bericht über die Feier seines 100. Geburtstages an der Groosh. Technischen Hchschulen Fridericiana zu Karlsruhe. In: 26; Juni 1909, 1909.
- Reuleaux F (1877) Cinématique, Principes fondamentaux d'une théorie générale des machines (trans: Debize A). Edition française traduite de l'allemand edn. Librairie F.Savy,
- Reuleaux F, Moll CL (1862) Constructionslehre für den Maschinenbau, erster Band : die Construction der Maschinentheile. Fridriech Vieweh und Sohn, Braunschweig
- Riedler A (1894) Amerikanische technische Lehranstalten. Zeitschrift des Vereines deutscher Ingenieure 38:405-409, 507-514, 608-615, 629-636.
- Riedler A (1916) Emil Rathenau, und das Werden der Grosswirtschaft. Verlag von Julius Springer, Berlin
- Rodenacker WG (1970) Methodisches Konstruieren. Konstruktionsbücher. Springer Verlag, Berlin
- Roth K (1982) Konstruieren mit Konstruktionskatalogen. Springer Verlag, Berlin
- Rühl F (1955) Tagung der Konstrukteure in Berlin, Feingerätetechnik. Feingeätetechnik:187-189.

- Schoen L (1990) Friedrich von Hefner-Alteneck. In: Treue W, König W (eds) Techniker. Einzelveröffentlichungen der historischen Kommission zu Berlin 60. Berlinische Lebensbilder 6, Berlin, pp 227-247
- Severin D (2000) Franz Reuleaux, der Wissenschaftler und Ingenieur. In: 1799-1999, von der Bauakademie zur Technischen Universität Berlin, Geschichte und Zukunft. Eine Ausstellung der Technischen Universität Berlin aus Anlass des 200. Gründungstages der Bauakademie und des Jubiläums 100 Jahre Promotionsrecht der Technischen Hochschulen. Ernst und Sohn, Berlin, pp 300-304
- Siemens G (1961) L'Evolution de l'électrotechnique : Histoire de la maison Siemens. 1, L'époque de la libre entreprise. 1847-1910, vol vol.1, L'époque de la libre entreprise. 1847-1910. Alsatia, Colmar
- Simon HA (1969) The Sciences of the Artificial. M.I.T. Press, Cambridge, MA, USA
- Sinclair B (1974) Philadelphia's philosopher mechanics - a history of the Franklin Institute 1824-1865. History of Technology. The Johns Hopkins University Press, Baltimore
- Smeaton J (1810) Recherches expérimentales sur l'eau et le vent, considérés comme forces motrices, applicables aux moulins et autres machines à mouvement circulaire, suivies d'expériences sur la transmission du mouvement et la collision des corps (trans: Girard PS). Edition française edn. Courcier, Paris
- Smiles S (1874) James Brindley and the early engineers. TEE Publishing, Warwickshire, England
- Trendelenburg F (1975) Aus der Geschichte der Forschung im Hause Siemens. Geschichte in Einzeldarstellungen, Verein Deutscher Ingenieure, Nr 31. VDI-Verlag, Düsseldorf
- Tschochner H (1957) Construire et réaliser, manuel de l'ingénieur d'études (industries mécaniques) (trans: Traduit de l'allemand par Constant Bohn). Editions Eyrolles, Paris
- Vitruvius (1999) Ten Books on Architecture. Cambridge University Press, Cambridge, UK
- Wallace KM, Blessing LTM (2000) Observations on Some German Contributions to Engineering Design. In Memory of Professor Wolfgang Beitz. Research in Engineering Design 12:2-7.
- Ward TB, Smith SM, Finke RA (1999) Creative Cognition. In: Sternberg RJ (ed) Handbook of Creativity. Cambridge University Press, Cambridge, pp 189-212
- Wengenroth U (1990) Emil Rathenau. In: Treue W, König W (eds) Techniker. Einzelveröffentlichungen der historischen Kommission zu Berlin 60. Berlinische Lebensbilder 6, Berlin, pp 193-209