



**HAL**  
open science

## Active control design of modular tensegrity structures

Sarah Badra Amouri, Julien Averseng, Jean-François Dubé

► **To cite this version:**

Sarah Badra Amouri, Julien Averseng, Jean-François Dubé. Active control design of modular tensegrity structures. International Association for Shell and Spatial Structures (IASS) Symposium 2013, Sep 2013, Wroclaw, Poland. 5 p. hal-00869091

**HAL Id: hal-00869091**

**<https://hal.science/hal-00869091>**

Submitted on 2 Oct 2013

**HAL** is a multi-disciplinary open access archive for the deposit and dissemination of scientific research documents, whether they are published or not. The documents may come from teaching and research institutions in France or abroad, or from public or private research centers.

L'archive ouverte pluridisciplinaire **HAL**, est destinée au dépôt et à la diffusion de documents scientifiques de niveau recherche, publiés ou non, émanant des établissements d'enseignement et de recherche français ou étrangers, des laboratoires publics ou privés.

## Active control design of modular tensegrity structures

Sarah Amouri<sup>1</sup>, Julien Averseng<sup>2</sup>, Jean-François Dubé<sup>3</sup>

<sup>1</sup>PhD student, Laboratoire de Mécanique et Génie Civil, University Montpellier 2, Montpellier, France, [badra.amouri@univ-montp2.fr](mailto:badra.amouri@univ-montp2.fr)

<sup>2</sup>Assistant professor, Laboratoire de Mécanique et Génie Civil, University Montpellier 2, Montpellier, France, [julien.averseng@univ-montp2.fr](mailto:julien.averseng@univ-montp2.fr)

<sup>3</sup>Professor, Laboratoire de Mécanique et Génie Civil, University Montpellier 2, Montpellier, France, [jean-françois.dube@univ-montp2.fr](mailto:jean-françois.dube@univ-montp2.fr)

### Summary:

In this paper, a general methodology for the design of modular active tensegrity structures is presented. The objectives are to propose systems such as grids or footbridges that would be able to actively dampen their first vibration modes and to adapt their geometry using a small number of activators. This approach is validated experimentally on a plane regular tensegrity grid. Using numerical simulation, an application on the model of a modular tensegrity footbridge is presented.

**Keywords:** *Tensegrity, design, active control, numerical modelling*

### 1. INTRODUCTION

Tensegrity systems are a class of reticulated space structures, initially conceived and presented during the 1950's in the form of sculptures [1][2] (Fig. 1). They are composed of struts and tendons. Stability is provided by the self-stress state between tensioned and compressed elements. A widely accepted definition has been proposed in 2003 by Motro [3]: “Tensegrity is a system in a stable self-equilibrium state comprising a discontinuous set of compressed components inside a continuum of tensioned components.”

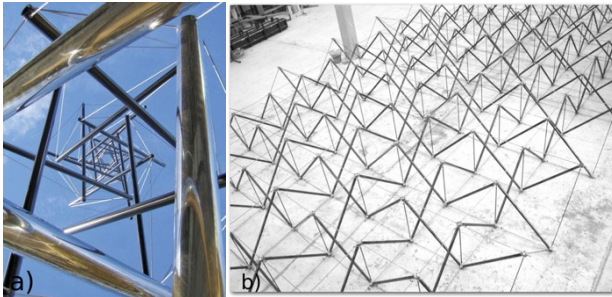

Fig. 1. a) Needle Towered (Kenneth Snelson, 1968), b) Tensarch project (LMGC/SLA, 2002.)

Attractive lightweight and transparent structures can be built using this concept. However, these systems exhibit usually a low rigidity and can be sensible to dynamic loads that may excite resonance modes, leading to unacceptable displacements. Active control is an efficient solution to improve their structural performances while keeping self-weight low.

Vibration control is about reducing the amplitude of vibrations of a structure. Several studies have been conducted on the active control of tensegrity systems. Djouadi and Motro [4], proposed a method based on a combination of the instantaneous optimal control algorithm and simulation using Newton-Raphson and Newmark methods. Skelton [5] derived the dynamics of tensegrity systems as a matrix differential equation form and proposed convenient formulation for active control. Averseng and Dubé [6] proposed an alternative control strategy using active synthesis of robust control. They divided the control law in two parts. The first dedicated to the static control. The second part concerns the dynamic control. Robust control technique was used to minimize the transfer between the external disturbances and the output taking into account uncertainties in the model and interfering signals on the system. Ali and Smith [7] presented the control of a smart structure by acting on its Eigen frequencies through modifications of the level of selfstress.

In this study, we focus on the vibration control of modular tensegrity structures. The objective is to propose new solutions for the active damping of the first modes. We present the experimental case of a

modular Tensarch grid for which the first modes of torsion and flexion are controlled using actuators incorporated into the structure. A general actuation mode that exploits blocked mechanisms is demonstrated for modular structure on the numerical model of a footbridge.

### 2. EXPERIMENTAL ACTIVE GRID

The structure used for experimental testing is a plane double layer tensegrity grid derived from the Tensarch Project [8] (Fig. 1). The topology of this structure, imagined by Motro and generated from a weaving of compressed bars between two continuous layers of tense cables, strongly implies the vertical tense components in the selfstress states. It occupies an area of 3,2 m×6,4 m or 20 m<sup>2</sup>.

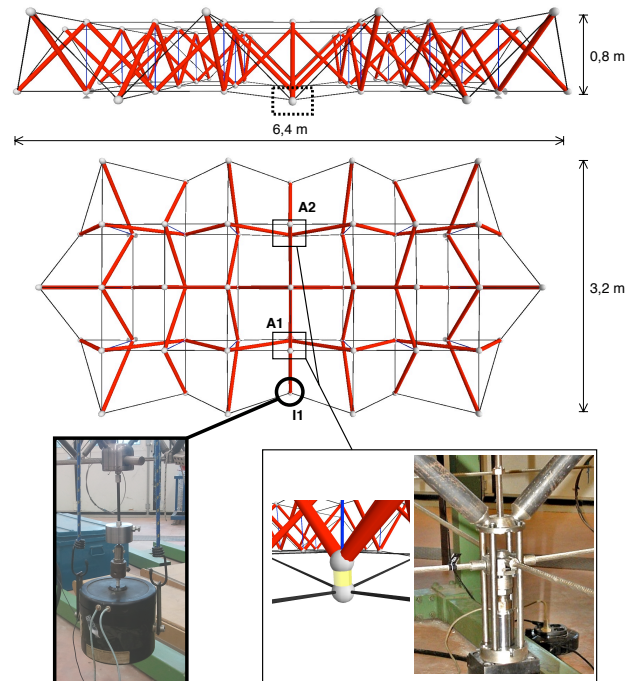

Fig. 2. Active Tensarch grid : actuators (A1 & A2) and excitation (I1)

This structure is equipped with two actuators in A1 and A2 (Fig. 2). They act vertically in pulling away the node from the lower layer, which increases the tension in the four adjacent cables and induces a vertical displacement of the corresponding side. The actuators are hydraulic jacks with dynamic performance going up to 30 Hz. Output vibration levels are measured in A1 and A2 on the top layer along the z axis using accelerometers. These positions are chosen so as to be able to measure

the effects of torsional and flexional modes. Indeed, the order 1 flexional mode implies that vertical displacements in A1 and A2 will be in phase and in opposition of phase for torsion of order 1 (Fig. 4). An external action is introduced using a suspended electrodynamic shaker, also placed eccentrically so as to excite flexional and torsional modes.

In this setup, the active grid can be viewed as a system admitting two inputs : one represents the command signals to the activators and the other the external force introduced by the shaker. There is one output that represents the measured accelerations. The behavior of this system can thus be modeled by two transfer response functions (Fig. 3).  $G_p$  represents here the passive behavior i.e. the transfer between the external force and the output while  $G_a$  is the transfer between the command sent to the actuators and the output.

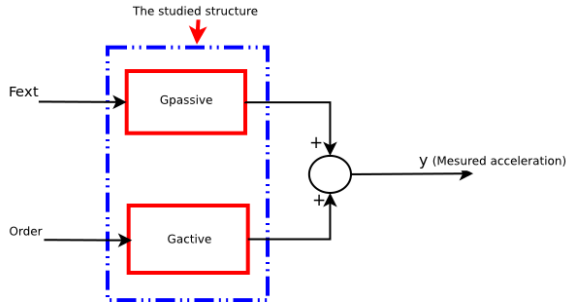

Fig. 3. Block model of the system

### 2.1. Passive behavior

To characterize the passive response  $G_p$ , a swept sine test is carried using the excitation shaker (Fig. 2). The behavior is then determined as the transfer function of the output vertical acceleration, in A1 in a first time, over the input force (Fig. 4). We see appearing the resonance peaks of the first torsional (13.4 Hz) and flexional (17.4 Hz) modes. The objective of active control will be to attenuate them.

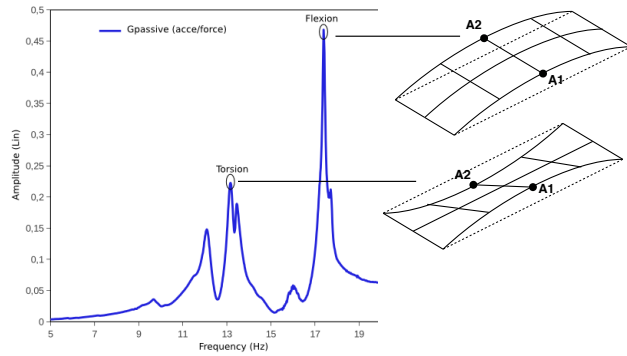

Fig. 4. Experimental passive dynamic response of the system

### 2.2. Active behavior

The response function  $G_a$  is characterized by the ratio of the output acceleration in A1 over the command signal. In order to optimize the impact of the activators on each mode of vibration, they are coupled : we command them in phase when it is a question of acting on the mode of flexion and in opposition of phase for the mode of torsion. Thus,  $G_a$  is characterized for each coupling configuration (Fig. 5). We observe that the actuators are able to control each mode by generating significant acceleration levels for each one.

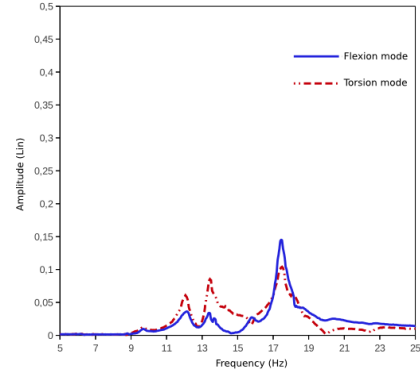

Fig. 5. Frequency response function of the active system, for actuators coupled in flexion and torsion

## 3. IDENTIFICATION OF THE BEHAVIOUR

The dynamic behavior of the studied structure is composed and identified as a piecewise function by similarity with a 1 degree of freedom rheological Kelvin-Voigt model for each domain (Fig.6). Three parameters  $M$ ,  $C$ ,  $K$  represent successively the mass, the damping force coefficient and the stiffness of the structure. The actuators are materialized by an element with variable length  $u(t)$ .

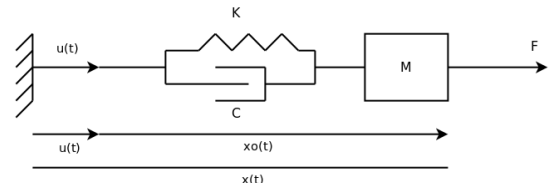

Fig. 6. Equivalent rheological model

### 3.1. Equivalent rheological model

The equilibrium equation for the equivalent model is written as follows :

$$M \ddot{x} = F - K(x - u) - C(\dot{x} - \dot{u}) \quad (1)$$

$$M \ddot{x} + C \dot{x} + K x = F + K u + C \dot{u} \quad (2)$$

The transfer function is established using the Laplace transform of (2) :

$$\mathcal{L}[M \ddot{x} + C \dot{x} + K x] = \mathcal{L}[F + K u + C \dot{u}] \quad (3)$$

$$M s^2 x(s) + C s x(s) + K x(s) = F(s) + K u(s) + C s u(s) \quad (4)$$

The passive part  $G_p$  expresses the relationship between the external excitations  $F_{ext}$  and measure output  $y$ . The  $G_a$  transfer represents the relationship between each activator and the vertical acceleration  $y$ . Using (4), we obtain the following expressions :

$$G_a = \frac{\ddot{x}(s)}{u(s)} = \frac{s^2(C s + K)}{M s^2 + C s + K} \quad (5)$$

$$G_p = \frac{\ddot{x}(s)}{F(s)} = \frac{s^2}{M s^2 + C s + K} \quad (6)$$

### 3.2. Parameters fitting

The angular frequency of the equivalent system is known to be  $\omega_0 = \sqrt{K/M}$ . Thus, by fixing the mass  $M$ , we can deduce initially the rigidity  $K$  from the peak of resonance. We can then adjust damping and the total level by a multiplying  $\alpha$  coefficient that represents the power gain of the chain of order and measurement. The set of parameters obtained is presented in Table 1.

Table 1. Mechanical parameters of equivalent models

frequency (Hz)	mode	M (kg)	K (N/m)	C (N.s/m)
13.42	torsion	100	280625	300
17.42	flexion	100	1198000	350

#### 4. ROBUST ACTIVE CONTROL

There are various modern methods of control [9][10][11], including algorithms robust synthesis (LQG, PRLQG,  $H_\infty$ ,  $\mu$ ) which takes into account the uncertainties and external disturbances affecting the system to design a robust controller. Robust control ensures the stability of the structure compared to many uncertainties, originally arising from parameters not controlled on the connections, selfstress, materials and loading over time (eg snow, which changes the mass structure).

The  $H_\infty$  approach explicitly takes into account the uncertainties prevailing in the system model or signals. It consists in minimizing the  $H_\infty$  norm of the transfer between disturbances on input and output criteria. A typical control loop is represented in Fig. 7.

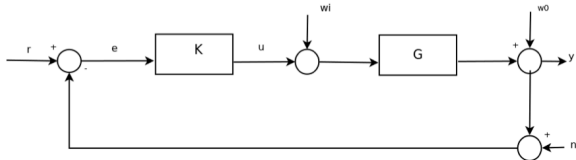

Fig. 7. Typical control loop

In this diagram, the control system is denoted G, K controller, r is the reference input, y the measured output and u is the command generated. The various uncertainties intervene additively in the form of external signals  $w_i$ ,  $w_o$ . The relationship between output y and different sizes is expressed by (7).

$$Y = (1 + GK)^{-1} w_o + (1 + GK)^{-1} G w_i + (1 + GK)^{-1} GK (r - n) \quad (7)$$

We introduce the following notations :  $S = (1 + GK)^{-1}$  and  $T = GK(1 + GK)^{-1}$ . S is the output sensitivity, transfer between disturbances in output  $w_o$  and y. T is the complementary output sensitivity of the system between n and output y. The transfer between  $w_i$  and y is SG. These functions are used to construct specifications of the controller. In our case, in order to have good performance, T must be higher in the bandwidth of the system and low beyond to eliminate the measurement noises. To attenuate the external actions, we need a low sensitivity S. Finally, the uncertainty of the system can be considered as a perturbation  $w_i$  as input, so the robustness requires a low transfer function KS.

To materialize these conditions, the closed loop is extended such that some internal signal, shaped by filters  $W_j$ , can be measured as criteria output, which leads to the form presented in Fig. 8.

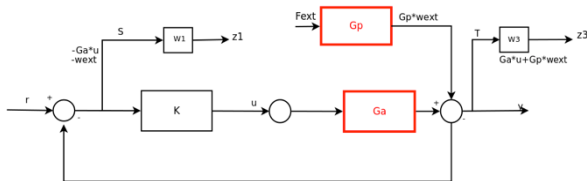

Fig. 8. Control loop for  $H_\infty$  synthesis

Using the formulation of the  $H_\infty$  method, the set of conditions is written in a convenient form call the “standard” form (Fig. 9), centered on the controller K.

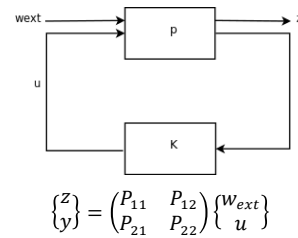

Fig. 9. Standard form of the control loop

The block P describes the links between the external signals ( $w_{ext}$  and z) and those within the loop (y and u). P has thus an input vector containing the command u and the  $w_i$  disturbances. In output, it provides y and  $z_i$  (signals that characterize the command loop and that we seek to minimize). y and  $z_i$  are internally weighted by functions  $W_i$  affecting S and T (Fig. 8). The respect of the conditions of performance put in form by the weight functions implies finally :

$$\begin{aligned} [W_1 S]_\infty &< 1 \\ [W_3 T]_\infty &< 1 \end{aligned} \quad (8)$$

z is a vector composed of  $z_1$  and  $z_3$ . The transfer function P is then :

$$P = \begin{pmatrix} -W_1 G_p & -G_a W_1 \\ W_3 G_p & G_a W_1 \\ -G_p & -G_a \end{pmatrix} \quad (9)$$

The problem of synthesis consists in finding the controller K, which uses measurement y to generate the order u making it possible to ensure the criteria of necessary robustness and stability. The criteria of stability correspond to the stability of the characteristic transfer functions S, T, KS, which must have their poles with negative real part.

#### 5. EXPERIMENTAL RESULT

We have developed two controllers adapted to each specific vibration modes, in flexion and torsion. They are implemented as z-filters in a control loop programmed using the LabView software on a dedicated workstation. Via a communication interface, the software performs the acquisition of the acceleration levels on the structure and the generation of commands to the actuators.

##### 5.1. Nominal case

The dominant frequency, for which the magnitude of the acceleration signal is maximized, is measured and used to switch the system onto the appropriate mode. Thus, when it is higher than 15 Hz, both actuators are controlled in phase to attenuate the mode of flexion.

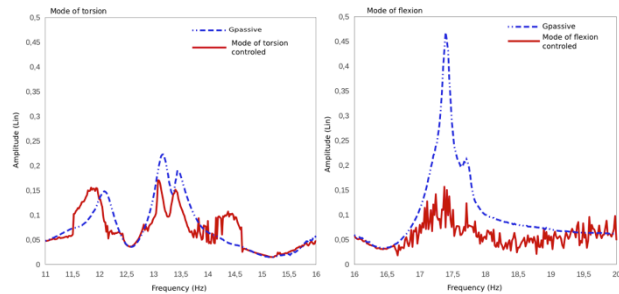

Fig. 10. Comparison between the experimental passive and controlled responses in torsion and flexion

The figure 10 shows a comparison between the passive system (transfer between the acceleration in output and the external force, without control) and the same transfer in the case where control is operative in torsion or in flexion. We notice a considerable attenuation of near 68% for the flexional mode and 36% of the peak of torsion.

## 5.2. Perturbed case

In order to study the robustness of the developed controller, we analyze the response of the structure in a case disturbed by suspending heavy steel blocks to the lower layer nodes. This addition of mass represents nearly 15% of the initial total weight.

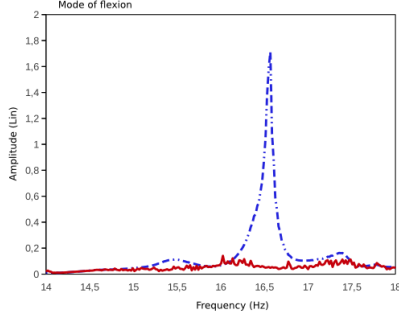

Fig. 11. Experimental controlled response of the flexion mode (structure altered by addition of mass)

The figure 11 shows a comparison of the responses with and without control of the perturbed system around the flexion mode. We see that the peak is shifted slightly to lower frequencies, which is consistent with the increase in mass. It was found that the active control is still effective and provides an important reduction of about 90%. Although this result is encouraging, further investigations are needed to better characterize the domain of validity and stability of the active system.

## 6. EXTENSION TO OTHER MODULAR SYSTEMS

Using simulation, new active tensegrity structures that use similar actuation principle can be proposed. We take here the case of a 12 m long curved tensegrity footbridge the main structure of which is an assemblage of 2x8 class 1 four bars modules. The main vibrations modes of this beam are in flexion. The proposed actuation mode consists in controlling the length of transverse cables (A1 and A2 in Fig 12). The role of these elements is already to rigidify the beam in flexion under vertical load by blocking mechanisms [12]. Thus, they are naturally effective in influencing the vertical deflection.

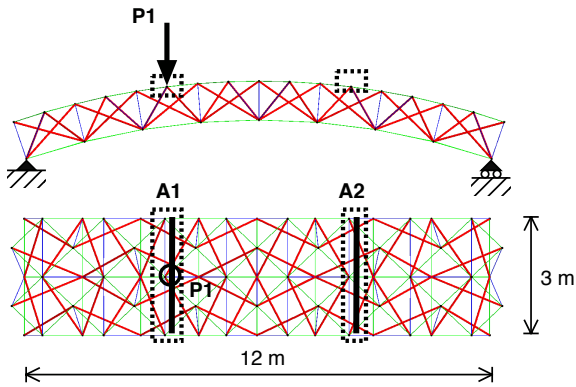

Fig. 12. Curved tensegrity beam

We analyze the behavior by simulating swept sine tests using an explicit dynamic approach [13], computing the evolution of the system through time. An external sinusoidal force is introduced in A1, in the middle of the upper layer, in order to excite the first two flexion modes. The output is the amplitude of the vertical displacement at the same point. The response function of this displacement in function of the frequency of the external force represents the passive behavior  $G_p$  (Fig. 13). This response exhibits the two flexional modes in the range 0 – 20 Hz.

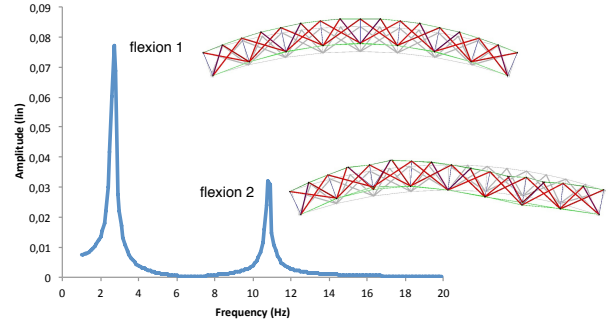

Fig. 13 Computed passive behavior  $G_s$  of the tensegrity beam

Actuators are coupled in phase for mode 1 and in opposition of phase for mode 2. In addition, we also evaluate the case where only one actuator is effective in A2. We present in figure 14 the active behavior of the system for the different cases.

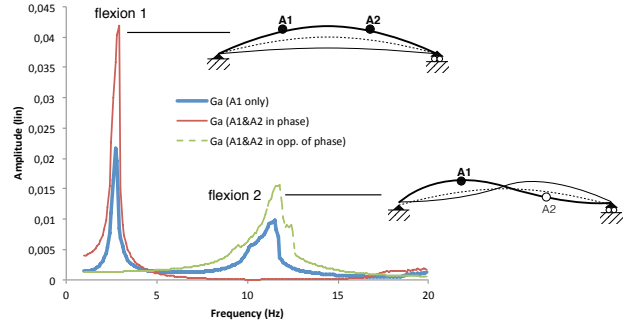

Fig. 14. Active behavior  $G_p$  of the beam, obtained by simulating swept sine tests

Actually, activating only A1 seems sufficient, using only one set of active cables in this point, as the FRF of this configuration is in the same order of amplitude as  $G_p$ . To evaluate the potential of this solution, a simple control loop is implemented. We simulate a perfect feedback by controlling the length of actuator cables proportionally to the excitation, in opposition of phase. Two controllers are implemented and switched at 7 Hz. Although this is an ideal configuration, this approach allows raising the potentialities of the chosen actuation mode. The results in Fig. 15 demonstrate that the amplitude of vibrations for the first two modes in flexion can be significantly attenuated using only one localized actuator commanded by a piecewise-defined controller.

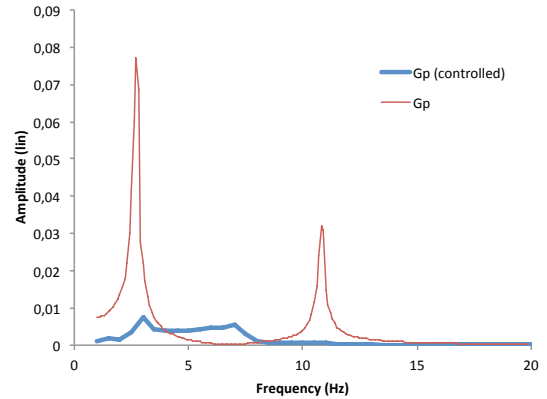

Fig. 15. Simulated passive and active response of the proposed modular tensegrity beam

## 7. CONCLUSION

After studying the modal characteristics of our double layer tensegrity grid, we developed a strategy to actively control the vibration modes encountered. The controller is synthesized on robust concepts coupled to a simple modeling of the structure. It is characterized by a piecewise behavior with 1 degree of freedom. The controller parameters are set accordingly for each range. The original approach provides high performance results on the attenuation of the modes. Moreover, a slight modification of the characteristics of the structure showed that the system remained stable and efficient. The approach should be generalized in a first time on other modes by studying other disturbances to check its relevance. The presented actuation mode, that exploits the selfstressed characteristic of tensegrity, is extended to another modular system through simulation. We demonstrate the potential of using cables that are used to block soft mechanism for rigidity purpose. The whole approach allows us to propose and design new, lighter and advanced tensegrity structures.

## 8. REFERENCES

- [1] Fuller, *The dymaxion world of Buckminster Fuller*, Anchor Books, NewYork (1973)
- [2] Snelson K., *Tensegrity Mast*, Shelter Publication, Bolinas, California (1973)
- [3] Motro, R., *Tensegrity: structural systems for the future*, London, Kogan Page Science (2003)
- [4] Djouadi S., Motro R., *Active control of tensegrity systems*, Journal of Aerospace Engineering, vol. 11, No. 2, (1998) p. 37-44.
- [5] Skelton R., *Dynamics and control of tensegrity systems*, Solid Mech Appl (2005) p. 309-318.
- [6] Averseng J., Dubé J.F., *Active control of a tensegrity plane grid*, Proceedings of the 44th IEEE Conference on Decision and Control and the European Control Conference, Sevilla, (2005) pp. 6830-6834.
- [7] Ali, NBH, and Smith, IFC. *Dynamic Behavior and Vibration Control of a Tensegrity Structure*, International Journal of Solids and Structures, vol. 47, no. 9 (2010), pp. 1285-96.
- [8] Motro R., *Tensarch : A tensegrity double layer grid prototype*, Fifth international conference on space structure, University of Surrey, Guildford, UK (2002), Thomas Telford, USA, pp. 57-66.
- [9] Doyle JC., *Analysis feedback systems with structured uncertainties*, Control Theory and Applications, IEE Proceedings D, vol. 129, no 6 (1982) pp. 242-250.
- [10] Fezans N., Alazard D.,  *$H_\infty$  control design for generalized second order systems based on acceleration sensitivity function*, IEEE 16th Mediterranean conference on Control and Automation, Ajaccio, (2008)
- [11] Tuanejjeil I., *Robust vibration control of flexible tensegrity structure via  $\mu$  synthesis*, Structural control and health monitoring, vol. 20, no. 20 (2013) pp. 173-186.
- [12] Averseng, J., Dubé, J.-F., *Design, analysis and self stress setting of a lightweight deployable tensegrity modular structure*, Proceedings from Steel Structures And Bridges 2012 - 23rd Czech And Slovak International Conference, (2012)
- [13] Averseng, J., Quirant, J., Dubé, J.-F., *Interactive design and dynamic analysis of tensegrity systems*, International Journal of SEWC, 1(2), 2011, pp. 20-25.