



HAL
open science

Nodes and Structures - A tribute to Stéphane Du Château

René Motro

► **To cite this version:**

René Motro. Nodes and Structures - A tribute to Stéphane Du Château. (IASS) Symposium 2013 "BEYOND THE LIMITS OF MAN", Sep 2013, Wroclaw, Poland. 8 p. hal-00867855

HAL Id: hal-00867855

<https://hal.science/hal-00867855>

Submitted on 30 Sep 2013

HAL is a multi-disciplinary open access archive for the deposit and dissemination of scientific research documents, whether they are published or not. The documents may come from teaching and research institutions in France or abroad, or from public or private research centers.

L'archive ouverte pluridisciplinaire **HAL**, est destinée au dépôt et à la diffusion de documents scientifiques de niveau recherche, publiés ou non, émanant des établissements d'enseignement et de recherche français ou étrangers, des laboratoires publics ou privés.

« Nodes and Spatial Structures », a tribute to Stéphane Du Chateau

Motro René¹

¹ Professor Emeritus, University Montpellier 2, Montpellier, France, *motro@univ-montp2.fr*

Summary: The work of Stéphane Du Chateau is clearly inscribed in the second half of the twentieth century. He developed several spatial structures systems based on a clever design of nodes, which were all patented. More than two hundred and fifty projects were effectively built. Besides this productive work Stéphane Du Chateau founded several associations in order to gather designers and to promote Spatial Structures. His charisma and his commitment were the keys of a remarkable contribution to spatial structures.

Keywords: *Spatial Structures, Du Chateau, Node, Industrialisation, Institut Le Ricolais*

1. INTRODUCTION

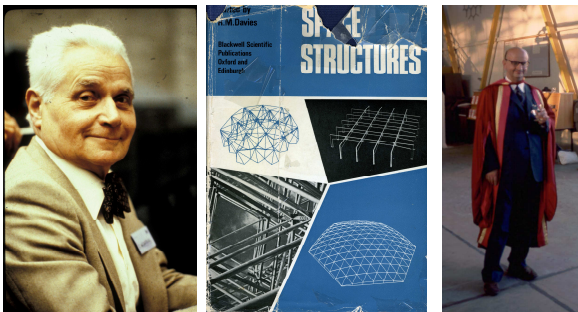

Fig. 1 Stéphane Du Chateau - Zygmunt Stanislas Makowski.

Stéphane Du Chateau, was born in Solwyczoqdzk, in 1908, and after the second world war, worked in France, until his death in 1999.

He clearly introduced me in the world of spatial structures, knowing my personal interest for this field. As far as I remember we met for the first time in Montpellier at the School of Architecture where I taught strength of materials. Three years before, in 1966, he attended the first International Conference on Space Structures in Guildford, this conference was organized by Zygmunt Stanislas Makowski. The proceedings were very impressive (Fig. 1). S. Du Chateau was one of the authors who participated to this event, his paper was titled “L’intégration de la pensée technique dans la création architecturale”. It was included in the part 7 “Design: The Future”[1]. Everything is said in this title “technical thought”, “creation”, “architecture” these words described the man. The paper was written in French (and authors like M. Mengerhausen and Y. Friedman wrote also in their own native language), but S. Du Chateau spoke always French, and from time to time, during the following years he asked me to translate his lectures.

It was in these years when simultaneously eminent designers, Frei Otto, Eduardo Torroja could submit innovative lightweight structures taking advantage of emerging numerical methods. In 1962 Nicolas Esquillan, the designer of the CNIT (Paris), organized the IASS Symposium in Paris. This event was devoted to “Hanging Roofs” and Frei Otto gave first lecture titled “Inleitende bemerkungen zum colloquium”.

The International Association for Shell and Spatial Structures was founded three years ago by Eduardo Torroja. Stéphane Du Chateau urged me to join this Association, I did.

2. A DISTINGUISHED PERSON

Certainly few people saw him in conferences without his famous bow tie, symbol of distinction and sincere courtesy. This was the symbol of his deep humanity and culture. Educated as architect he always claimed the necessity to have a good understanding of the program. Attached to the French language, he made it a point of honor to make interventions in French, having made sure that a majority of the attending persons could understand him. He always presented his works with slides, and

actually our University received the whole collection of them, thanks to his nephew; who is living in south of France. Architect, engineer but also painter Stéphane Du Chateau was in the French meaning “un honnête homme”. His works and curriculum are well described by Tadeusz Barucki [2]. Is it necessary to say, here in Poland, that his office in Paris was the place where his fellow country people were insured to find the assistance and the welcome which they needed? Certainly not. Perhaps some of you may testify it.

3. AN IMAGINATIVE ENGINEER

3.1. Basic ideas

Stéphane Du Chateau was one of the most productive engineers in the field of spatial structures during the second half of the twentieth century. He was a specialist of tubular construction and worked in close relation with Zygmunt Stanislas Makowski who was established in London (at Imperial College), and then in Guildford Surrey (at the Space Structure Research Centre). The difference between the two words “space” and “spatial” is meaningless in this paper. Stéphane Du Chateau was a specialist of geometry and was able to design all kinds of spatial structures: double layer grids, vaults, double curved systems... But he had always two main concerns in head: the node and the industrialization process. All people who were involved in spatial structures design, know that the main question to solve is the node design.

3.2. Nodes

3.2.1. Bidirectional solution- Unibat

At the beginning of double-layer grids, most of them were bi-directional. They contained two parallel layers, “top” and “bottom” ones, and in between bracing members. Geometrically speaking one of the solutions was to get a forty five degrees relative rotation between the main directions of the top layer and the bottom layer, both being a square meshing. Stéphane Du Chateau was convinced that it was more efficient than a “square on square” choice. This was confirmed by the results that I published in 1975 [3]; self-weight was significantly reduced. I am indebted to Stéphane Du Chateau, Zygmunt Stanislas Makowski and Hoshyar Nooshin who urged me to do this work, when I visited the Space Structures Centre in Guildford (1973).

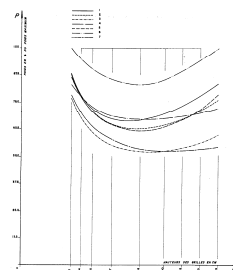

Fig. 2 Self-weight of double-layer grids (by the author [3]).



Fig. 3 Unibat system (Stéphane Du Chateau).

Which was the node for this geometry, for this Unibat system? **No one**, since there is no node parts for this double layer grid. It is realized with square pyramids that are assembled by a single horizontal bolt at the corners of the squares that constitute the upper layer (basis of the pyramids). The other edges of the pyramid are the bracing members. The bottom layer is the simplest that can be found: members are not cut to meet the geometrical sizes, the whole length of tubes is kept, but they are crushed at necessary distances and drilled so as to introduce a bolt through two bottom layer members crossing at 90° , and the apex of the pyramid where four bracing members are joined. It can be said that this is a solution without nodes, or with bolts as nodes: the simplest solution that could be found.

The lightness and the transparency are resulting from this design. In 1976, I organized a colloquium on structures in Montpellier [4], and for this event we assembled two double layer grids so as to constitute a kind of vault inside our University.

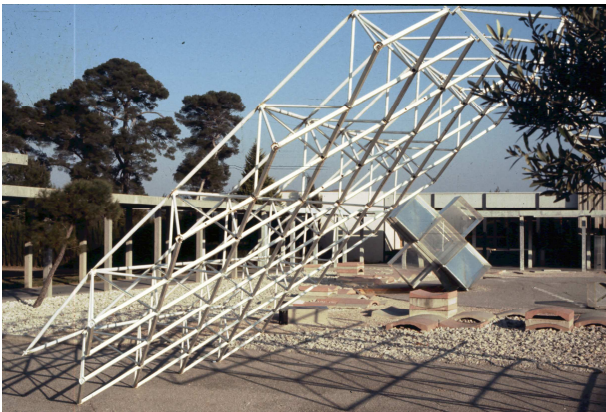

Fig. 4 Two assembled double layer grids inside the University garden.

3.2.2. Three directional solutions

Stéphane Du Chateau was also aware of the structural efficiency of double curved system and realized what he called a “three directional” cupola in Grandval with a very clever molded steel node. This cupola has a diameter equal to 42 m. The radius of the complete sphere is equal to 40 m. With a sag of 6 m, the total length of members is 2136 m, and there are 313 nodes.

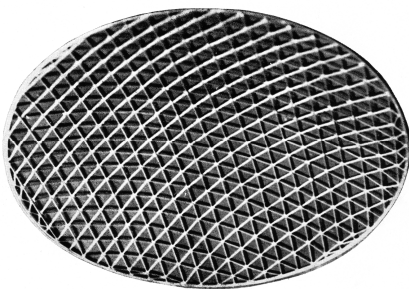

Fig. 5 Grandval double curved system – Physical model.

Stéphane Du Chateau was convinced by the rigidifying effect of the double positive curvature, and simultaneously by the efficiency of the three-directional orientation of the members that was also in accordance with the triangular in plane shape. He had to solve the meshing of the double curved surface. It is worthy to say that geometrically speaking it is not easy to determine the length of every member. If triangles look similar they are not, and in these times there was no form-finding software to help the designer. But the principle relies on three intersecting hexagonal regular arches, and in between a triangular partition.

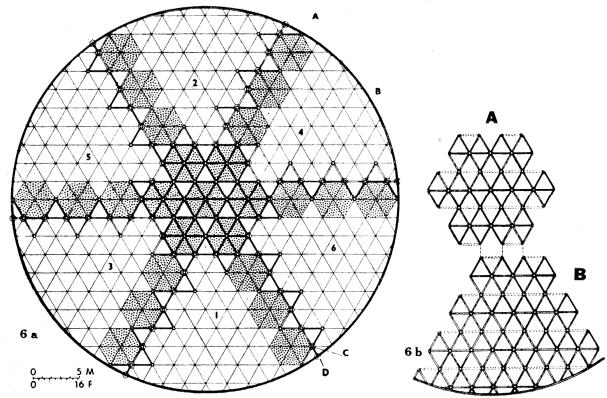

Fig. 6 Geometrical pattern.

But designers used to build physical models at small-scale and to measure the length of every member on this model. The precision was not achieved exactly, and one of the constraints for the node design was to allow length modification during the realization itself. It was also necessary to find a way to get a double curvature system. Stéphane Du Chateau designed and patented the “SDC node”.

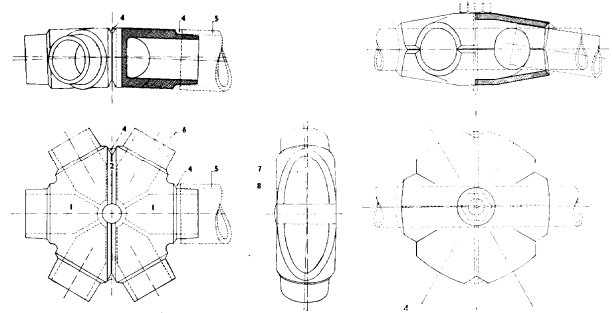

Fig. 7 “SDC node” Drawings.

It can be seen on the drawings of Fig. 7 how the three main problems were solved:

- Every node can receive six members
- By entering more or less the tubes inside the node, the length constraint is solved. All members can be of the same size, the variations are absorbed by the penetration length inside the node.
- The curvature is possible since the space inside the node allows providing the required inclination of the members (only some degrees are sufficient).

Once the design achieved in terms of geometry, the following step is to choose a realization process. Welding is governing this process: the node is molded in two parts that are welded together when members are correctly in place meeting the geometrical constraints of size and angles. Subgroups of members are realized at the ground level and then included in the whole spatial structure.



Fig. 8 “SDC” node.

As far as three directional flat double grids are concerned, it can be also useful to describe another solution designed by Stéphane Du Chateau for a three directional double layer, built in Nîmes, close to the highway.

The design principle chosen by Stéphane Du Chateau is similar to bidirectional solutions presented in section 13.2.1: tubes are crushed and drilled (bottom layers), and in this case specific pieces are designed for joining members of the bottom layer with again only one bolt. On the upper layer, the mesh is triangular and three bolts are necessary at each node. The node’s design must include not only the physical existence of this specific piece, the node, but also all the surrounding constraints, from its industrialization to their implementation by the use of adapted tools for which it is necessary to make way. The “holes” that appear on the top layer are used to introduce the tools that are used to tighten the bolts



Fig. 9 Tri-directional grid. Bottom layer “node” and top layer “node”.

3.2.3. Spherical node : Spherobot

Even if Unibat was successful it appeared that Du Chateau’s realizations needed another system with nodes and members, which are easier to transport than pyramids. And all specialists knew the success of the “Mero” node in these years. Taking advantage of the contest for Baltimore airport (1975), American architects were willing to use a spherical node. Du Chateau designs a drilled sphere that can receive the members. Some times after the research for a spherical node enabling the assembly of members whatever can be their relative positions, ends in a spherical node. It is realized with two pieces: one is one third of a sphere, the second one is two-thirds of a sphere.



Fig. 10 Spherobot.

One axial node is used to assemble the two pieces, socket head cap screws are used to assemble the members to the node itself. Conical rod end housings can also be manufactured for some members (Fig. 11)

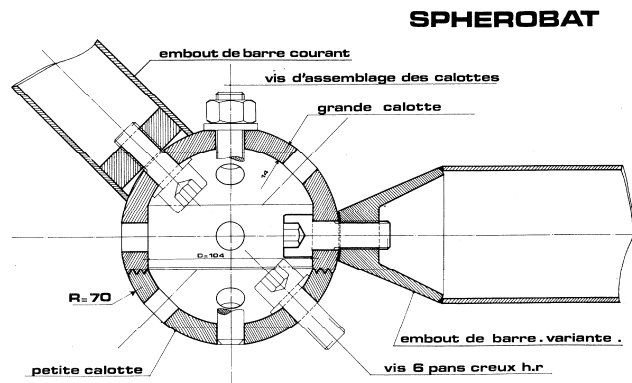

Fig. 11 Spherobot. design principle.

3.3. Industrialization and Patents

Stéphane Du Chateau patented many systems. Pyramitec, Tridimatec, Unibat, Spherobot are some of them.

Doing so he was able to build around two hundred and fifty projects based on node’s patents. A comprehensive list of these projects can be found in the thesis submitted by Claudia Estrela Porto. [5].

Three constraints governed the design:

- Simple manufacturing in factory
- Easy transport and storage
- Simplified implementation



Fig. 12 Industrialized components

All along his design process Stéphane Du Chateau used to work with Zygmunt Stanislas Makowski, who was able to make a numerical analysis of his structures and for some cases experimental tests. This collaboration was very fruitful during this period of innovation.

4. A TIRELESS DEFENDER OF SPATIAL STRUCTURES

Du Chateau worked with the most famous engineers and architects in the whole world. He was consulted by Frei Otto for a foldable membrane in Cannes, France, certainly one of the first foldable membrane project.



Fig. 13 Du Chateau and Frei Otto

The first central mast buckled and a new one was designed by Stéphane Du Chateau.

Founder of many associations, Stéphane Du Chateau tried to unify the action of French designers namely in his "IRASS" ("Institut de Recherche et d'Applications des Structures Spatiales") where famous engineers and architects exchanged their ideas. Paul Maymont, Jean Cesselin (for cable nets), Yona Friedman (architecture), Chaperot (polycorolles), Lourdin (timber spatial structures) were some of them. We organized together several events in France in order to publicize spatial structures, namely in Paris, Lyon and Rennes. He invited in Paris Felix Candela, and was very proud to honor him.

L'INSTITUT LE RICOLAIS
Institut de Recherche et d'Applications des Structures Spatiales

vous prie de bien vouloir assister à la conférence
HIER & DEMAIN, ARCHITECTURE
par
FÉLIX CANDELA

qui se tiendra au Grand Palais le 14 octobre 1981 à 18 h 30
sous le patronage de la DIRECTION DE L'ARCHITECTURE
DU MINISTÈRE DE L'URBANISME ET DU LOGEMENT
avec la participation de L'ACADÉMIE D'ARCHITECTURE, DE L'UNION INTERNATIONALE DES
ARCHITECTES, DE LA Sté AUGUSTE PERRET ET LE CERCLE D'ÉTUDES ARCHITECTURALES

R.S.V.P. 522.20.75 15, rue Hégésippe Moreau - Paris 18 ème

Fig. 14 Candela conference invitation (Paris, 1981)

All the "IRASS" regular meetings were held in his office in Paris "15 rue Hégésippe Moreau".

Christel Frapier described some of his activities in a paper published by the International Journal of Space Structures [7].

But Robert le Ricolais had a specific role. Unfortunately he could not find the necessary context and the financial support for his researches in France and migrated to Philadelphia.

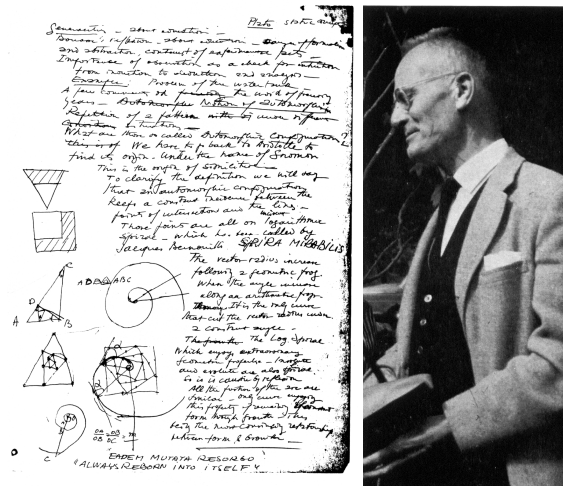

Fig. 15 "Always reborn in itself" – Le Ricolais

Robert Le Ricolais was unable to further his research in France, but many of his devotees endeavored to help him to do so, unfortunately with little success. Reference must be made here of the action of David Georges Emmerich who tried to set up a Structural Research Workshop that could have welcomed Le Ricolais. The last time he participated in this fervent group of followers (IRASS) he spoke in these terms, as related by Henri Drevon in January 1977 :

"Le Ricolais, who had taken two of his students with him, reported on the missions always assigned to him in the USA. He regrets that the doctors do not allow him to do more and that he has been unable to find an organization in France that would enable him to pursue his task. This entails, among other things, repatriating the impressive set of models

made with his students in Philadelphia, which would put up a very good show in Pompidou Center"

Further he writes:

"The proposal to honor Le Ricolais by transforming the IRASS into a Le Ricolais Foundation is adopted unanimously and with an ovation"

It is not surprising that the so-called "IRASS" became at the end the "Robert Le Ricolais Institute".

Tireless actor of spatial structures, Stéphane Du Chateau taught in many schools of architecture, increasing the curiosity of young people, organized several scientific meetings. I had the chance to share these experiences with him.

Consequently I asked him to be the honorary chairman of a scientific seminar on structural morphology that I organized in south of France [8]. It was simultaneously possible to organize two exhibitions one devoted to Robert Le Ricolais, and one to his close friend Stéphane Du Chateau. In both cases we could exhibit models from their projects and studies.

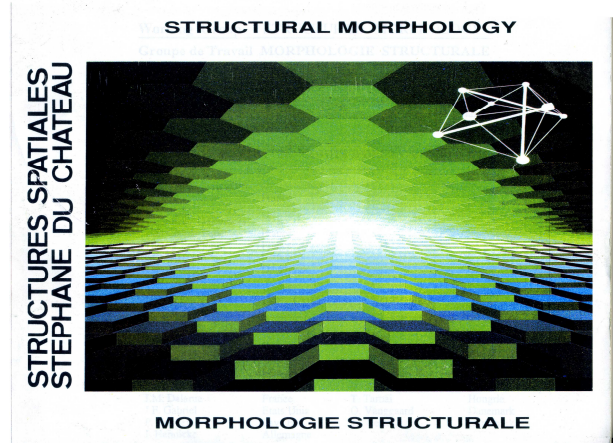

Fig. 16 S. Du Chateau Exhibition Catalog 1992.

5. CONCLUSION

Stéphane Du Chateau was undoubtedly one of the leaders in the field of Space Structures during the second half of the twentieth century. Designer, architect, space structures defender, teacher, he was a multiple expertise man. I had the honor and privilege to work with him in many circumstances and had the opportunity to discover his deep humanity.

I also received a wonderful collection of slides from his nephew, and my task is now to give access to this collection, and to coordinate my action with polish people in charge of his foundation in Hrubieszow.

6. REFERENCES

- [1] Du Chateau S., *L'intégration de la pensée technique dans la création architecturale*, Proceedings of the First International Conference on Space Structures, Edited by R.M. Davies, Blackwell Scientific Publications (1966) pp. 1180-1198.
- [2] Barucki T., *Stéphane Du Chateau, kanon*, (1995).
- [3] Motro R., *Optimisation de Structures Spatiales et application à des grilles à double nappe. (2 volumes)*. Thèse de Docteur Ingénieur. Université Paul Sabatier, Toulouse. 18 Avril 1975.
- [4] Motro R. ed., *Colloque Recherches en Structures : Bilan et Perspectives*. Université Montpellier II. 1976.
- [5] Estrela Porto C., *L'évolution des Structures Spatiales à travers l'œuvre de Stéphane Du Chateau*, Thèse Université Paris 1 (1993)
- [6] Motro R., Wester T. *Proceedings of the first International Seminar on Structural Morphology*. IASS WG 15. 500 pages, 45 papers, two exhibitions. September (1992). Montpellier. France

- [7] Frapier C. *Stéphane Du Chateau*, Special Issue « The pioneers of Space Structures », International Journal of Space Structures, Vol 21. N° 1, 2006.
- [8] Motro R. ed, *Structural Morphology by R. Le Ricolais and S. Du Chateau*, Catalogs of the exhibition.