



**HAL**  
open science

## **(188)Re-SSS/Lipiodol: Development of a Potential Treatment for HCC from Bench to Bedside.**

Nicolas Lepareur, Valérie Ardisson, Nicolas Noiret, Etienne Garin

► **To cite this version:**

Nicolas Lepareur, Valérie Ardisson, Nicolas Noiret, Etienne Garin. (188)Re-SSS/Lipiodol: Development of a Potential Treatment for HCC from Bench to Bedside.. *International Journal of Molecular Imaging*, 2012, 2012, 278306 (9 p.). 10.1155/2012/278306 . hal-00866975

**HAL Id: hal-00866975**

**<https://hal.science/hal-00866975>**

Submitted on 27 Sep 2013

**HAL** is a multi-disciplinary open access archive for the deposit and dissemination of scientific research documents, whether they are published or not. The documents may come from teaching and research institutions in France or abroad, or from public or private research centers.

L'archive ouverte pluridisciplinaire **HAL**, est destinée au dépôt et à la diffusion de documents scientifiques de niveau recherche, publiés ou non, émanant des établissements d'enseignement et de recherche français ou étrangers, des laboratoires publics ou privés.

## Research Article

# <sup>188</sup>Re-SSS/Lipiodol: Development of a Potential Treatment for HCC from Bench to Bedside

Nicolas Lepareur,<sup>1,2,3</sup> Valérie Ardisson,<sup>1,3</sup> Nicolas Noiret,<sup>2,3</sup> and Etienne Garin<sup>1,3</sup>

<sup>1</sup> Centre Régional de Lutte Contre le Cancer Eugène Marquis, INSERM UMR-S 991, Avenue de la Bataille Flandres-Dunkerque, CS 44229, 35042 Rennes, France

<sup>2</sup> Ecole Nationale Supérieure de Chimie de Rennes, CNRS UMR 6226, Avenue du Général Leclerc, CS 50837, 35708 Rennes, France

<sup>3</sup> Université Européenne de Bretagne, 35000 Rennes, France

Correspondence should be addressed to Nicolas Lepareur, n.lepareur@rennes.unicancer.fr

Received 12 October 2011; Revised 8 December 2011; Accepted 13 December 2011

Academic Editor: John Humm

Copyright © 2012 Nicolas Lepareur et al. This is an open access article distributed under the Creative Commons Attribution License, which permits unrestricted use, distribution, and reproduction in any medium, provided the original work is properly cited.

Hepatocellular carcinoma (HCC) is the 5th most common tumour worldwide and has a dark prognosis. For nonoperable cases, metabolic radiotherapy with Lipiodol labelled with  $\beta$ -emitters is a promising therapeutic option. The Comprehensive Cancer Centre Eugène Marquis and the National Graduate School of Chemistry of Rennes (ENSCR) have jointly developed a stable and efficient labelling of Lipiodol with rhenium-188 ( $E_{\beta_{\max}} = 2.1$  MeV) for the treatment of HCC. The major “milestones” of this development, from the first syntheses to the recent first injection in man, are described.

## 1. Introduction

Hepatocellular carcinoma (HCC) is the fifth most common tumour worldwide and even ranks second in terms of mortality [1, 2]. Moreover, only a small number of cases are eligible to curative treatments, such as resection or transplantation. For the rest, a wide range of palliative treatments can be proposed, among which are chemoembolisation and radioembolisation with Lipiodol [3–6]. Lipiodol is an oily medium which has shown to be selectively retained in tumour when administered intra-arterially [7]. Lipiodol has been labelled with iodine-131 [8, 9], rhenium-188 [10, 11], yttrium-90 [12, 13], holmium-166 [14], and lutetium-177 [15]. Some early trials with phosphorus-32 have also been described [16]. However, to date, only the first two have been used in man, the iodine-131-labelled Lipiodol (Lipiodol) having a market authorisation. <sup>188</sup>Re-labelled Lipiodol seems the most promising one, being able to circumvent the major drawbacks of iodine-131 (long half-life, medium beta energy, strong gamma energy, and cost). Indeed, rhenium-188 has ideal properties for molecular radiotherapy ( $E_{\beta_{\max}} = 2.1$  MeV with a maximum tissue penetration of 11 mm,  $E_{\gamma} = 155$  keV (15%),  $t_{1/2} = 17$  h) and has the added advantage of being available on a cost-effective day-to-day basis thanks to

its generator mode of production [17]. It has thus attracted much interest [18, 19].

First attempts to label Lipiodol with radioisotopes other than iodine-131 were done with a covalently bond chelate, with disappointing results [12, 20]. It was thus postulated that solubilisation of a lipophilic chelate into Lipiodol would make a suitable “radiolabelling” [21]. Soon after, several teams investigated this promising approach [22, 23]. It is in that context that the Centre Eugène Marquis and the Ecole Nationale Supérieure de Chimie de Rennes (ENSCR) decided to combine respectively their experience on radioembolisation of HCC with <sup>131</sup>I-Lipiodol [9, 24–27] and knowledge of technetium and rhenium coordination chemistry [28–31], to label Lipiodol with a <sup>188</sup>Re chelate of their own design.

## 2. Synthesis

**2.1. <sup>185/187</sup>Re/<sup>99</sup>Tc Syntheses.** Previous studies at the ENSCR led to the preparation of a new class of complexes with perthiobenzoate and dithiobenzoate moieties [M (PhCS<sub>3</sub>)<sub>2</sub> (PhCS<sub>2</sub>)<sub>2</sub>] which structure is given in Figure 1, both with rhenium [32] and with technetium-99 [33]. These complexes were nicknamed SSS, standing for “Super-Six sulphur”,

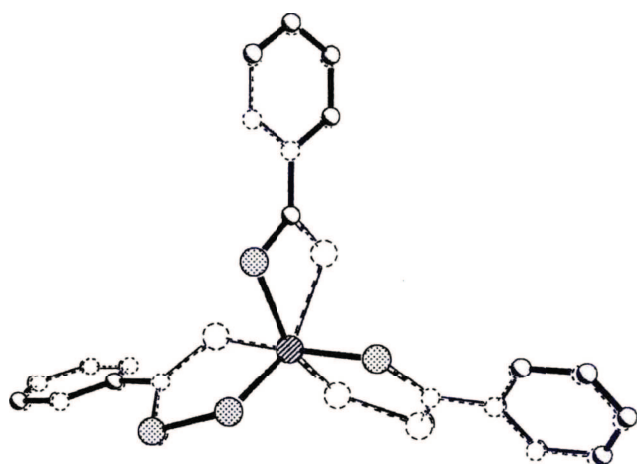

FIGURE 1: Superposition of the crystal structures of  $^{185/187}\text{Re}$ -SSS and  $^{99\text{m}}\text{Tc}$ -SSS complexes (reprinted from: N. Lepareur, Ph.D. thesis no. 2003 REN 10110, 2003).

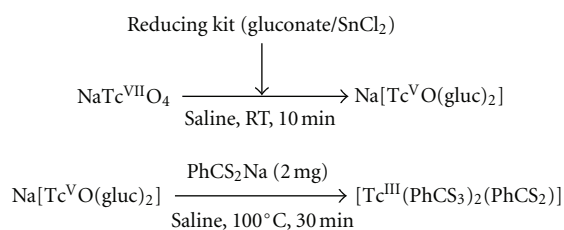

FIGURE 2: Synthesis of  $^{99\text{m}}\text{Tc}$ -SSS.

because the metal core is coordinated by six sulphur atoms. One of the interests of these complexes is that the metal is at the oxidation state +III, which is more stable than +V and they are, in addition, susceptible to bifunctional approach to design target-specific agents [31, 34].

**2.2.  $^{99\text{m}}\text{Tc}$  Synthesis.** The SSS complex was subsequently prepared with technetium-99 m, using a freeze-dried kit method (containing 0.75 mg tin chloride, 75 mg calcium gluconate, and 25 mg sodium chloride, diluted 1/10), initially in a view of lymphocytes labelling [35]. The complex was obtained, according to procedure shown in Figure 2, with good yield and good radiochemical purity (>95%). Moreover, it proved to be very stable and to be quite lipophilic ( $\log P = 3.33$ ).

It was, therefore, a good candidate to label Lipiodol. The method previously described by Jeong et al. [22] was used, that is, once the complex is synthesised, 2-3 mL of Lipiodol Ultra-Fluide (simply called Lipiodol) is added. The mixture is shaken then centrifuged at 2200 g for 10 min, and the phases are carefully collected.  $^{99\text{m}}\text{Tc}$ -SSS/Lipiodol is thus obtained with a  $96 \pm 2.8\%$  yield and a final RCP of  $92.5 \pm 2.6\%$  [36]. The preparation showed satisfactory reproducibility, and the labelling proved to be stable.

**2.3.  $^{188}\text{Re}$  Synthesis.** Rhenium-188 is obtained in the form of perrhenate by elution of a  $^{188}\text{W}/^{188}\text{Re}$  generator, similar to the  $^{99}\text{Mo}/^{99\text{m}}\text{Tc}$  generator. The major difference lies in

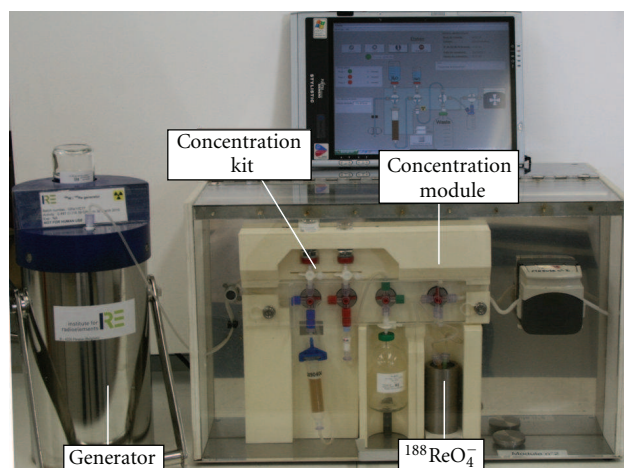

FIGURE 3:  $^{188}\text{W}/^{188}\text{Re}$  generator and its remote-controlled elution/concentration system (IRE, Fleurus, Belgium).

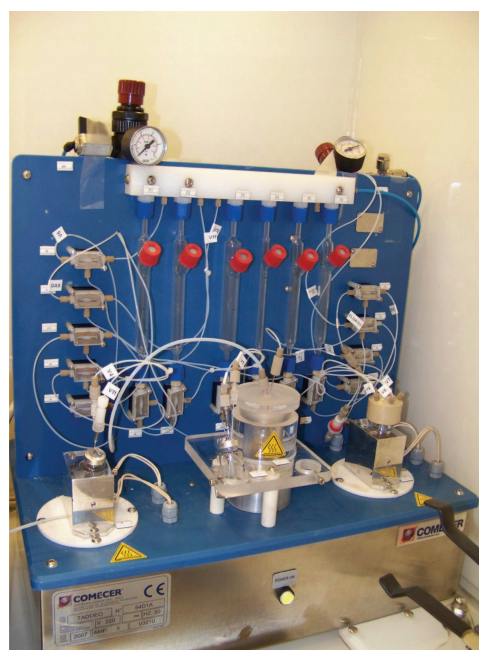

FIGURE 4: TADDEO module (COMECER, Castel Bolognese, Italy).

the necessity of postelution concentration to obtain high-volumic activity (up to 20 GBq/mL with a 37 GBq generator), due to the lower specific activity of  $^{188}\text{W}$  compared to  $^{99}\text{Mo}$ , necessitating a bigger alumina column (see Figure 3). First trials to prepare  $^{188}\text{Re}$ -SSS proved to be disappointing. Indeed, rhenium-188, though its chemistry is very close to that of technetium-99 m, is much harder to reduce and tends to reoxidise very quickly. It requires harsher reaction conditions. As a consequence, reaction conditions as well as kit composition had to be modified [37]. Amounts and type of reducing agent were varied as well as ancillary ligand. Antioxidants and chelating agents were added. Volume, pH, heating temperature, and reaction time were also modulated. Eventually, the solution came with the adjunction of potassium oxalate, which eases the reduction of perrhenate by

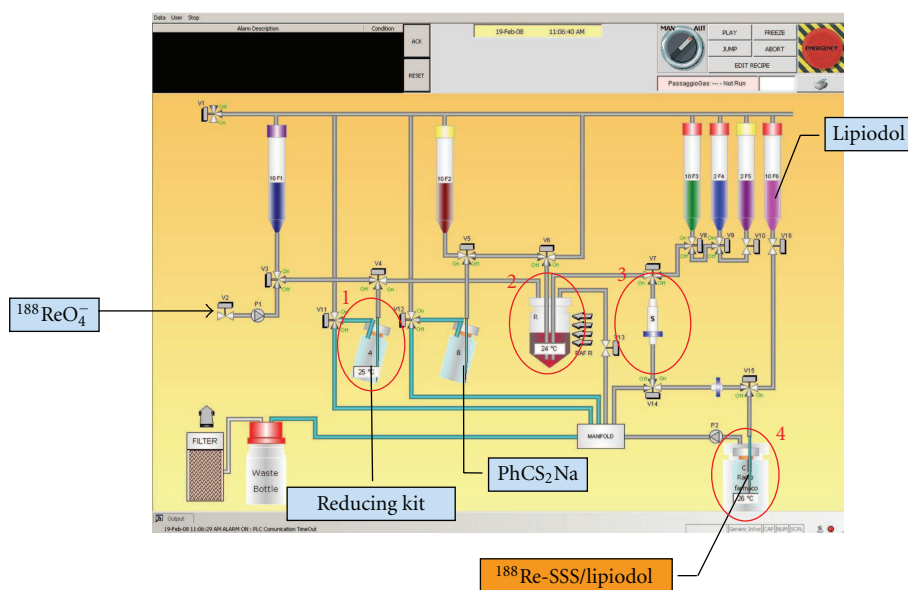

FIGURE 5: Flowchart of the TADDEO module for the preparation of  $^{188}\text{Re}$ -SSS/Lipiodol.

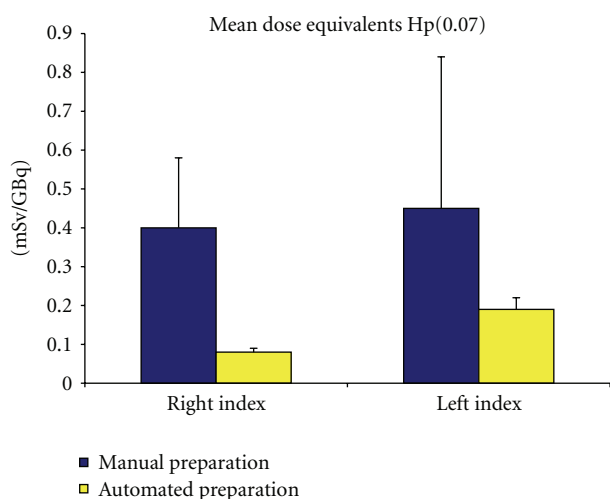

FIGURE 6: Mean dose equivalents (mSv/GBq) for both hands for manual ( $n = 3$ ) and automated ( $n = 2$ ) preparations of  $^{188}\text{Re}$ -SSS/Lipiodol, measured with TLD fixed at the tips of the indexes.

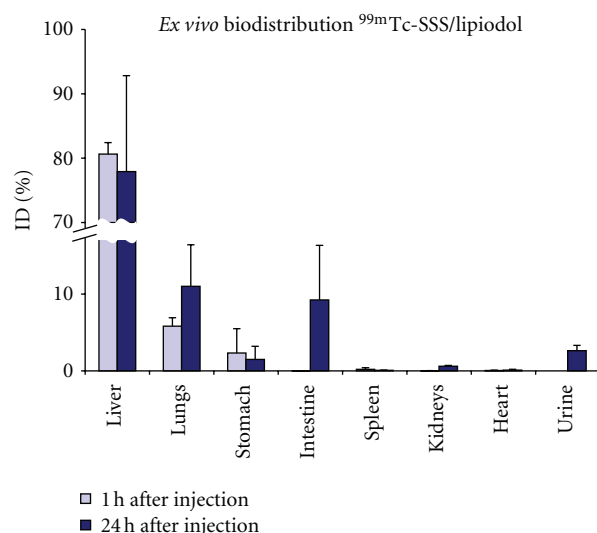

FIGURE 7: *Ex vivo* biodistribution of  $^{99m}\text{Tc}$ -SSS/Lipiodol in healthy pigs ( $n = 2$  for each time point).

expanding its coordination sphere, as shown by Boschi et al. [38]. Finally, the optimal procedure was determined as

Kit formulation: 0.8 mg  $\text{SnCl}_2 \cdot 2\text{H}_2\text{O}$  (dissolved in 0.1 mL HCl 1 M), 7.5 mg sodium gluconate, 30 mg ascorbic acid, and 40 mg potassium oxalate. This freeze-dried kit is reconstituted in 0.5 mL saline, and the perrhenate (0.5 mL of saline) is then added. After 15 min at room temperature, 20 mg of sodium dithiobenzoate is added, and the solution is heated for 30 min at  $100^\circ\text{C}$ , to provide the  $^{188}\text{Re}$ -SSS complex, as a precipitate. 2-3 mL of Lipiodol is added to the mixture, which is then centrifuged, as previously described with technetium-99 m.  $^{188}\text{Re}$ -SSS/Lipiodol was obtained with a  $87 \pm 9.1\%$  yield and a final RCP of  $93 \pm 3.4\%$ . Labelling was further optimised to reach  $97.3 \pm 2.1\%$  yield and a final RCP of  $94.1 \pm 1.7\%$  [39].

**2.4. High-Activity Upgrade and Automation.** A new efficient and stable labelling of Lipiodol was described. However, for activities above 1850 MBq (therapeutic activities), the labelling yield decreased dramatically. Consequently, the synthesis had to be further improved, in view of HCC treatment. Kit formulation was tuned, and reaction conditions were slightly modified.

A freeze-dried kit (4 mg  $\text{SnCl}_2 \cdot 2\text{H}_2\text{O}$  (dissolved in 0.1 mL HCl 1 M), 30 mg sodium gluconate, 30 mg ascorbic acid, 40 mg potassium oxalate) is reconstituted in 0.5 mL saline, and the perrhenate (0.5 mL of saline) is then added. After 15 min at room temperature, 40 mg of sodium dithiobenzoate is added, and the solution is heated for 15 min at  $100^\circ\text{C}$ , to provide the  $^{188}\text{Re}$ -SSS complex, as a precipitate. 2-3 mL of Lipiodol is added to the mixture,

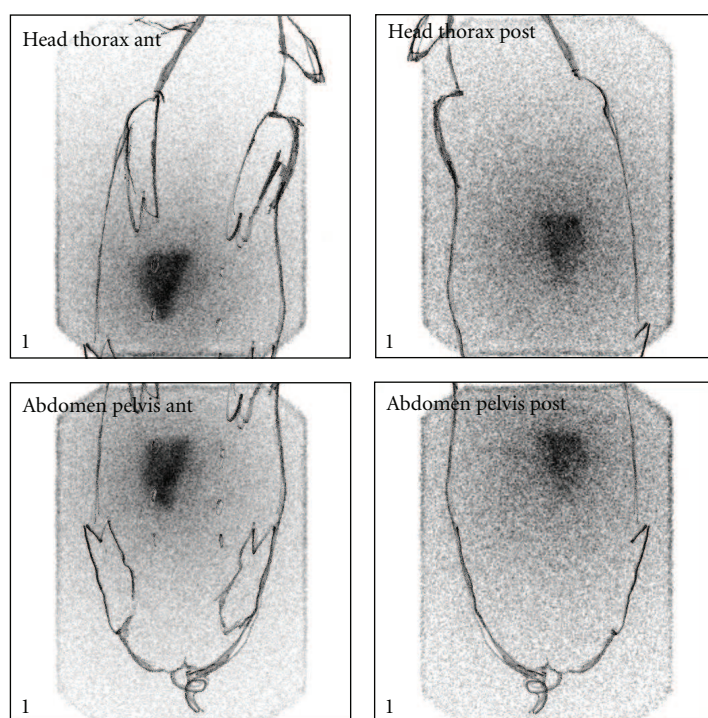

FIGURE 8: Scintigraphic scans of  $^{188}\text{Re}$ -SSS/Lipiodol 48 h after intra-arterial injection in healthy pigs.

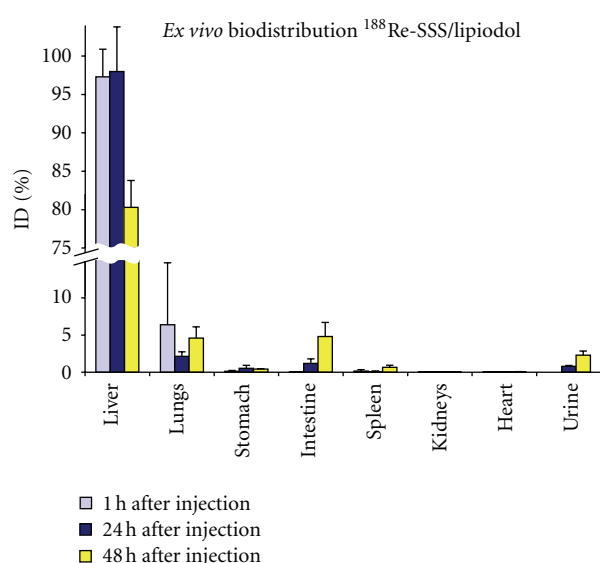

FIGURE 9: *Ex vivo* biodistribution of  $^{188}\text{Re}$ -SSS/Lipiodol in healthy pigs ( $n = 2$  for each time point).

which is then stirred with a vortex. After 10 min of centrifugation (2200 g), both phases are separated, and the lower phase (radiolabelled Lipiodol) is carefully recovered.  $^{188}\text{Re}$ -SSS/Lipiodol is obtained with a  $98.56 \pm 1.2\%$  yield and a final RCP of  $92.52 \pm 2.3\%$  and is stable for at least 7 days [40].

Having to handle high activities of  $^{188}\text{Re}$  to prepare therapeutic doses can result in an excessive radiation exposure to the operator, and particularly at the finger tips [41].

The authors have thus developed an automated procedure to limit the radiation exposure to the personnel, as well as to have a reproducible synthesis, in view of clinical trials [40]. The remote-controlled system employed is a TADDEO module (COMECER, Castel Bolognese, Italy) and is displayed in Figure 4. The radiolabelling procedure was once more adapted to be automated. The main change was the substitution of the centrifugation step and the use of solid-phase extraction cartridges to purify the product. The final yield is somewhat lower than with manual preparation ( $52.68 \pm 9.6\%$ ), due to the loss of activity in the tubing and the vessels (Figure 5).

The foremost gain of the automation was in the dose received by the operator. This is particularly true for the dose to the extremities. Impact of the automation was studied with thermoluminescent dosimeters (TLD) fixed at the finger tips, and, respectively, 80 and 58% decreases in the right-hand and left-hand doses were shown [42]. Personal dose equivalents—measured with continuously readable EPD dosimeters—were reduced by 38 and 43% for Hp (10) and Hp (0.07), respectively. Mean dose equivalents (mSv/GBq) for both hands are displayed in Figure 6.

### 3. Preclinical Studies

Good targeting and stability of radiolabelled Lipiodol were investigated *in vivo*, in healthy pigs, then in hepatoma-bearing rats. The radiotracer was injected through the hepatic artery, and biodistribution was checked by scintigraphy and *ex vivo* countings. Autoradiography was also done, to assess more precisely the fixation of the radiotracer.

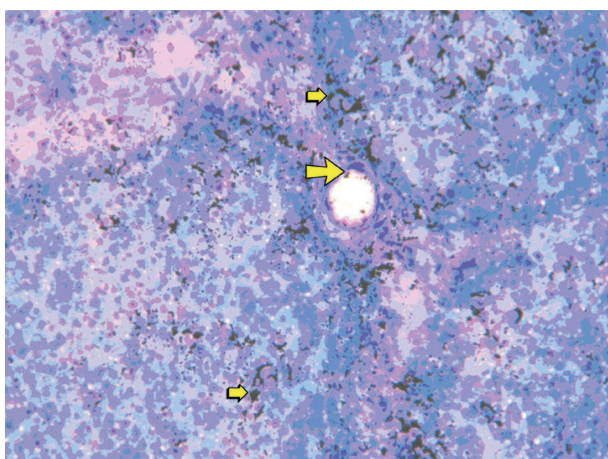

FIGURE 10: Fused autoradiography/histology tissue stain of the liver, 1 h after intra-arterial injection of 30 MBq of  $^{188}\text{Re}$ -SSS/Lipiodol. Radioactivity (black spots) is weakly noticeable in the region of hepatic artery and portal space (big yellow arrow) and strongly in capillary sinusoids (small yellow arrow), May Grumwald Giemsa coloration,  $\times 40$ .

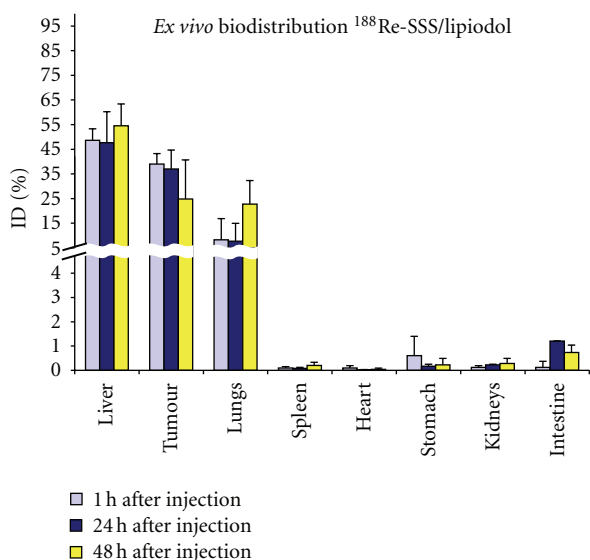
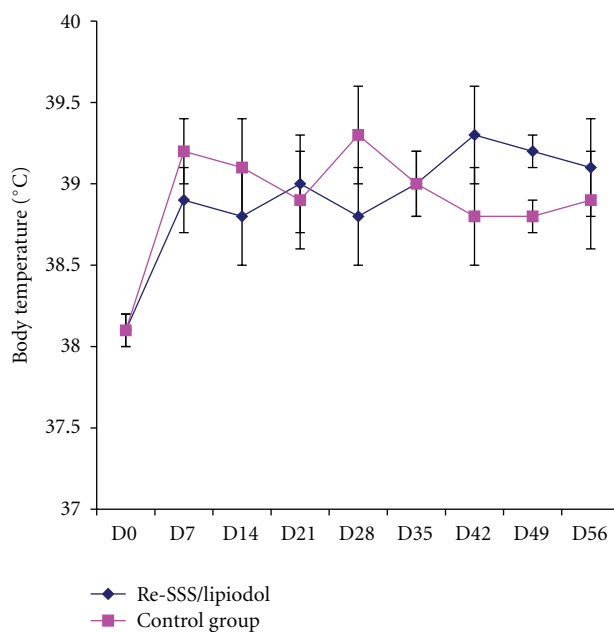

FIGURE 11: *Ex vivo* biodistribution of  $^{188}\text{Re}$ -SSS/Lipiodol in hepatoma-bearing rats ( $n = 3$  for each time point).

3.1. *Healthy Pigs.*  $^{99\text{m}}\text{Tc}$ -SSS/Lipiodol could be useful for carrying pretherapeutic dosimetry studies, as is performed with  $^{99\text{m}}\text{Tc}$ -MAA for  $^{90}\text{Y}$ -labelled microspheres [43]. It was injected into the hepatic artery of healthy pigs and showed a biodistribution pattern similar to that of  $^{131}\text{I}$ -labelled Lipiodol in human [36]. It has a preferential liver uptake, as shown in Figure 7. Fixation was stable and showed only mild digestive elimination 24 h after injection.

$^{188}\text{Re}$ -SSS/Lipiodol was also investigated in healthy pigs [44]. Scintigraphic scans (Figure 8) and *ex vivo* countings (Figure 9) show the quasiexclusive hepatic fixation, with a slight pulmonary uptake (not visible on scintigraphy). The fixation also proved to be stable with a very weak



(a)

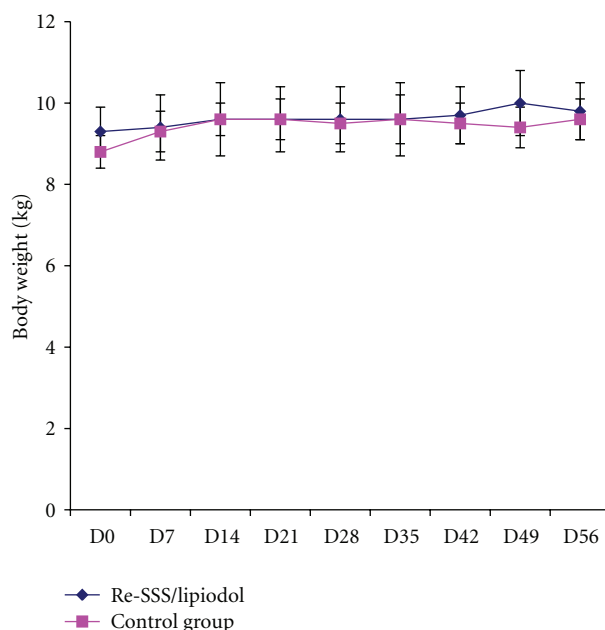

(b)

FIGURE 12: Physiological parameters; toxicity study in dogs ( $n = 4$  for each group).

urinary and intestinal elimination. At the microscopic level, the radioactivity is mainly—and rapidly—located in the sinusoids (Figure 10), as Lipiodol alone [45], where it is retained.

3.2. *HCC-Bearing Rats.* Unfortunately, no porcine model of hepatocarcinoma was described, and attempts to develop one with human hepatocarcinoma cells in immunodepressed pigs with cyclosporine gave no results. On the contrary, murine hepatoma models are well documented. It was

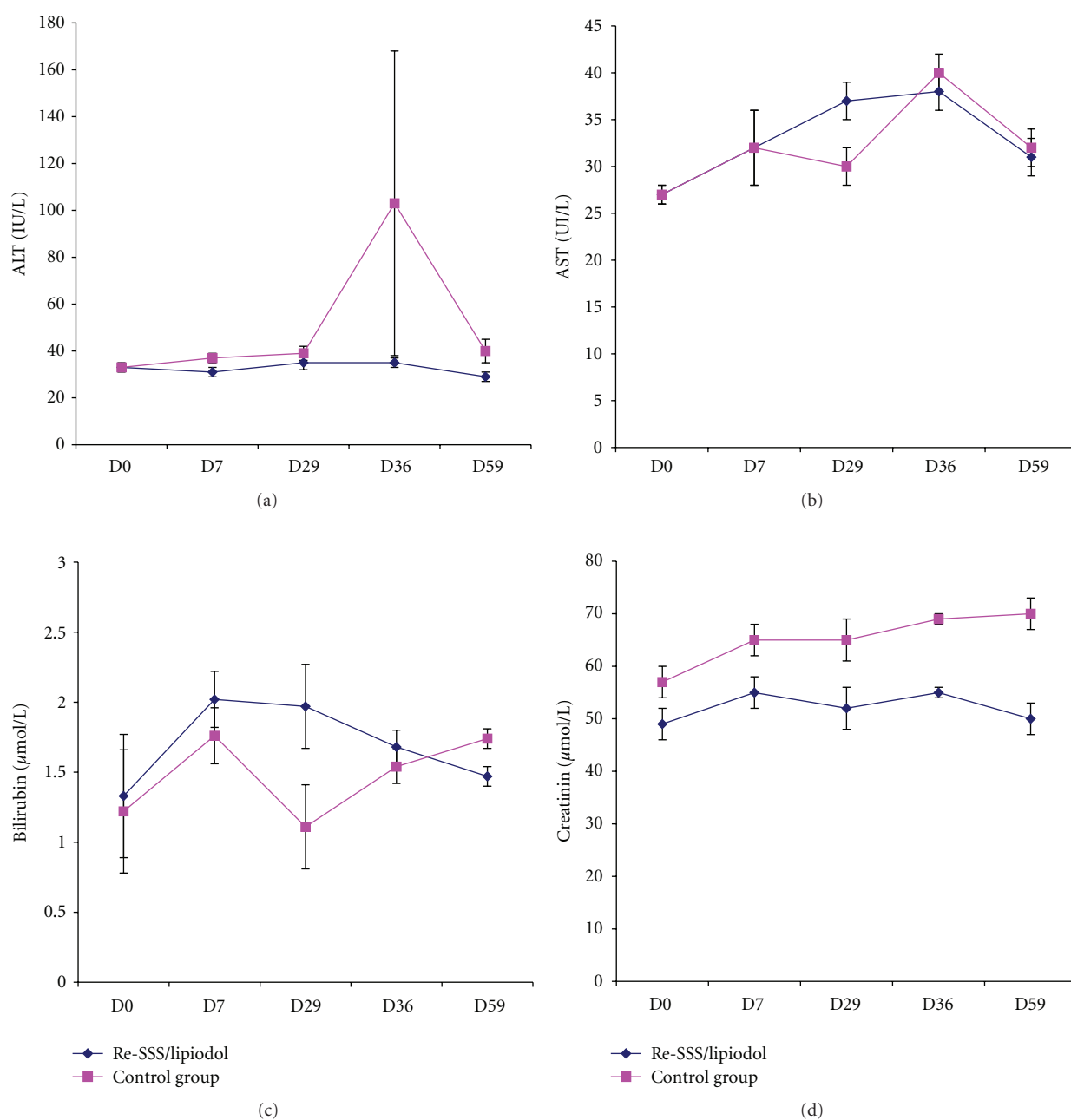

FIGURE 13: Some clinical chemistry values; toxicity study in dogs ( $n = 4$  for each group); ALT (alanine transaminase), AST (aspartate transaminase), and bilirubin are biomarkers of liver function; creatinin is a marker of renal function.

thus decided to investigate the tumour uptake of  $^{188}\text{Re}$ -SSS/Lipiodol in rats inoculated with N1S1 hepatocarcinoma cell line [39]. Our team, in collaboration with J. P. Benoit's team in Angers, developed a new technique for the tumoral inoculation as well as the intra-arterial injection [46].

Results showed preferential hepatic uptake, with a weak to moderate pulmonary uptake, and, most importantly a good tumour retention (Figure 11). This is consistent with the other  $^{188}\text{Re}$ Relabelled Lipiodol methods. The tumour-to-liver ratio increases from  $2.9 \pm 1.5$  to  $4.1 \pm 0.7$  between 1 h and 48 h. However, this model has its limitations, notably the fact that a single small tumour in a rat is probably too small for

rhenium-188 to be truly effective. Indeed, when compared to  $^{131}\text{I}$ -lipiodol, the latter proved to be more effective [47].

**3.3. Toxicology Studies.** To assess the safety of the radiotracer, a toxicity study—acute and chronic—has been undertaken in dogs (Beagles), with the nonradioactive analogue  $^{185/187}\text{Re}$ -SSS/Lipiodol, prepared in the same conditions as for clinical preparation (sterile GMP kits, same amounts of reactants, remote-controlled procedure). The Re-SSS/Lipiodol was injected for less than 24 h after preparation.

The study comprised two phases. For the first phase (7 days), animals (3 males + 3 females) received a single

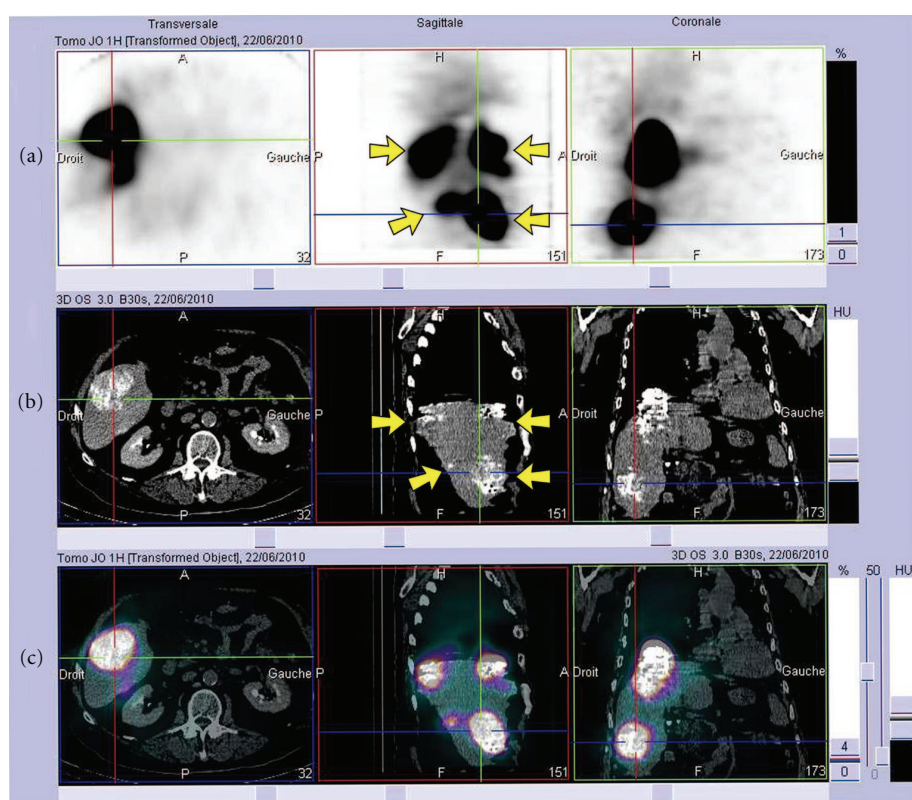

FIGURE 14: Scintigraphy (a) showing intense hyperfixation (in black) in 4 tumour foci, CT scan (b) showing intense Lipiodol retention (in white) in the nodules and fusion image (c) of scintigraphy and CT scan; 71-year-old male, 1 h after injection of 1.85 GBq of  $^{188}\text{Re}$ -SSS/Lipiodol. Transverse, sagittal, and coronal views.

injection at D1, and for the second one, animals (2 males + 2 females) received one dose at D1 and one at D30. Control group (5 males + 5 females) received Lipiodol alone. Some results are summarised in Figures 12 and 13. No change related to the parenchyma of organs or at the site of injection has been detected, either at D7 or at D59.

This study thus demonstrated lack of toxicity of Re-SSS/Lipiodol, opening the way for the injection in human.

#### 4. Clinical Investigation

Files were submitted to the relevant authorities, that is, French Agency for the Safety of Health Products (AFSSAPS), French Nuclear Safety Authority (ASN), and Ethical Committee (*Comité de Protection des Personnes*, CPP), and approval was eventually granted. A phase 1 escalation dose study was thus initiated (Lip-Re-1, EudraCT no. 2009-013231-37). This study will comprise 4 dose stages, ranging from 1.85 to 7.4 GBq. Each stage will comprise 3 to 6 patients, depending on the toxicity (or lack thereof) of the compound. To date, 5 patients have been injected (3 with 1.85 GBq and 2 with 3.7 GBq). For illustration, SPECT/CT scans of the third patient 1 h after injection of 1.85 GBq of  $^{188}\text{Re}$ -SSS/Lipiodol are shown in Figure 14, displaying the good targeting of the radiopharmaceutical candidate (tumour-to-nontumour max ratio = 15). 4 nodules are clearly visible on the sagittal plane. This patient (71-year-old

male, with multifocal HCC, in progression after Sorafenib treatment) responded well to the treatment, and his disease was stabilised for a couple of months.

#### 5. Conclusion

In conclusion, we have developed a potential HCC treatment by radioembolisation, with a phase 1 clinical trial currently in progress. This represents almost ten years of multidisciplinary research, from basic chemistry to clinic. Its clinical relevance has now to be demonstrated, and its efficiency and tolerance have to be compared to other existing therapeutic options.

#### Conflict of Interests

The authors declare that they have no conflict of interests.

#### Acknowledgments

The authors gratefully thank all those who supported this scientific project since its debuts, all the coauthors of papers, and the students who contributed to the project. They also thank their supervision authorities, as well as the region Brittany, ARC, French League against Cancer, and the Cancéropôle Grand-Ouest for their financial support. This



paper was partly the object of an oral presentation at the EANM, 2011 in Birmingham.

## References

- [1] J. Ferlay, H. R. Shin, F. Bray, D. Forman, C. Mathers, and D. M. Parkin, "Estimates of worldwide burden of cancer in 2008: GLOBOCAN 2008," *International Journal of Cancer*, vol. 127, no. 12, pp. 2893–2917, 2010.
- [2] A. Jemal, F. Bray, M. M. Center, J. Ferlay, E. Ward, and D. Forman, "Global cancer statistics," *CA: A Cancer Journal for Clinicians*, vol. 61, no. 2, pp. 69–90, 2011.
- [3] A. P. Venook, "Treatment of hepatocellular carcinoma: too many options?" *Journal of Clinical Oncology*, vol. 12, no. 6, pp. 1323–1334, 1994.
- [4] M. B. Thomas and A. X. Zhu, "Hepatocellular carcinoma: the need for progress," *Journal of Clinical Oncology*, vol. 23, no. 13, pp. 2892–2899, 2005.
- [5] E. Liapi and J. F. H. Geschwind, "Intra-arterial therapies for hepatocellular carcinoma: where do we stand?" *Annals of Surgical Oncology*, vol. 17, no. 5, pp. 1234–1246, 2010.
- [6] R. Lencioni, "Loco-regional treatment of hepatocellular carcinoma," *Hepatology*, vol. 52, no. 2, pp. 762–773, 2010.
- [7] F. I. Chou, K. C. Fang, C. Chung et al., "Lipiodol uptake and retention by human hepatoma cells," *Nuclear Medicine and Biology*, vol. 22, no. 3, pp. 379–386, 1995.
- [8] J. Liebster and V. Kocandrlje, "Exchange labelling of 'lipiodol' ultra fluids with iodine-131 and its intra-lymphatic administration with a fistula on the thoracic duct [34]," *Nature*, vol. 203, no. 4946, pp. 777–778, 1964.
- [9] J. L. Raoul, R. Duvauferrier, P. Bourguet et al., "Lipiodolized angiography in hepatocellular carcinomas. Contribution of iodine-131-labelled lipiodol," *Journal of Radiology*, vol. 67, no. 11, pp. 797–801, 1986.
- [10] N. Lepareur, V. Ardisson, E. Garin, and N. Noiret, "Therapy of hepatocellular carcinoma with Rhenium-188 Lipiodol," *Current Radiopharmaceuticals*, vol. 1, no. 2, pp. 87–92, 2008.
- [11] B. Lambert, K. Bacher, and L. Defreyne, "Rhenium-188 based radiopharmaceuticals for treatment of liver tumours," *Quarterly Journal of Nuclear Medicine and Molecular Imaging*, vol. 53, no. 3, pp. 305–310, 2009.
- [12] S. J. Wang, W. Y. Lin, W. Y. Lui, M. N. Chen, Z. T. Tsai, and G. Ting, "Hepatic artery injection of yttrium-90-lipiodol: biodistribution in rats with hepatoma," *Journal of Nuclear Medicine*, vol. 37, no. 2, pp. 332–335, 1996.
- [13] J. Yu, U. O. Häfeli, M. Sands, and Y. Dong, "90Y-oxine-thiodol, a potential radiopharmaceutical for the treatment of liver cancer," *Applied Radiation and Isotopes*, vol. 58, no. 5, pp. 567–573, 2003.
- [14] T. Das, S. Chakraborty, H. D. Sarma, M. Venkatesh, and S. Banerjee, "Preparation of 166Ho-oxine-lipiodol and its preliminary bioevaluation for the potential application in therapy of liver cancer," *Nuclear Medicine Communications*, vol. 30, no. 5, pp. 362–367, 2009.
- [15] S. Subramanian, T. Das, S. Chakraborty et al., "Preparation of 177Lu-labeled oxine in lipiodol as a possible agent for therapy of hepatocellular carcinoma: a preliminary animal study," *Cancer Biotherapy and Radiopharmaceuticals*, vol. 25, no. 5, pp. 539–543, 2010.
- [16] G. Kloss, O. Christ, and M. Volz, "Verteilungsuntersuchungen von 32P-Lipiodol UF am Hund nach intralymphatischer Applikation," *Nuklearmedizin*, vol. 1968, supplement 8, pp. 91–95, 1970.
- [17] F. F. Knapp Jr, "Rhenium-188 - A generator-derived radioisotope for cancer therapy," *Cancer Biotherapy and Radiopharmaceuticals*, vol. 13, no. 5, pp. 337–349, 1998.
- [18] J. M. Jeong and J. K. Chung, "Therapy with <sup>188</sup>Re-Labeled Radiopharmaceuticals: an Overview of Promising Results from Initial Clinical Trials," *Cancer Biotherapy and Radiopharmaceuticals*, vol. 18, no. 5, pp. 707–717, 2003.
- [19] B. Lambert and J. M. H. de Klerk, "Clinical applications of <sup>188</sup>Re-labelled radiopharmaceuticals for radionuclide therapy," *Nuclear Medicine Communications*, vol. 27, no. 3, pp. 223–229, 2006.
- [20] S. J. Wang, W. Y. Lin, M. N. Chen et al., "Radiolabelling of Lipiodol with generator-produced <sup>188</sup>Re for hepatic tumor therapy," *Applied Radiation and Isotopes*, vol. 47, no. 3, pp. 267–271, 1996.
- [21] T. W. Jackson, M. Kojima, and R. M. Lambrecht, "Rhenium diamino dithiol complexes. III lipophilic ligands for endotherapeutic radiopharmaceuticals," *Australian Journal of Chemistry*, vol. 53, no. 11-12, pp. 983–987, 2000.
- [22] J. M. Jeong, Y. J. Kim, Y. S. Lee et al., "Lipiodol solution of a lipophilic agent, <sup>188</sup>Re -TDD, for the treatment of liver cancer," *Nuclear Medicine and Biology*, vol. 28, no. 2, pp. 197–204, 2001.
- [23] A. Boschi, L. Uccelli, A. Duatti et al., "A kit formulation for the preparation of <sup>188</sup>Re -lipiodol: preclinical studies and preliminary therapeutic evaluation in patients with unresectable hepatocellular carcinoma," *Nuclear Medicine Communications*, vol. 25, no. 7, pp. 691–699, 2004.
- [24] J. L. Raoul, *Huiles iodées: un vecteur d'agents thérapeutiques dans le cancer primitif du foie. Développement du Lipiodol®*, Ph.D. thesis, 1996, 1996REN1B016.
- [25] J. L. Raoul, D. Guyader, J. F. Bretagne et al., "Prospective randomized trial of chemoembolization versus intraarterial injection of <sup>131</sup>I-labeled-iodized oil in the treatment of hepatocellular carcinoma," *Hepatology*, vol. 26, no. 5, pp. 1156–1161, 1997.
- [26] E. Boucher, S. Corbinais, Y. Rolland et al., "Adjuvant Intra-arterial Injection of Iodine-131-Labeled Lipiodol after Resection of Hepatocellular Carcinoma," *Hepatology*, vol. 38, no. 5, pp. 1237–1241, 2003.
- [27] E. Garin, S. Laffont, Y. Rolland et al., "Safe radiation exposure of medical personnel by using simple methods of radioprotection while administering <sup>131</sup>I-lipiodol therapy for hepatocellular carcinoma," *Nuclear medicine communications*, vol. 24, no. 6, pp. 671–678, 2003.
- [28] F. Demaimay, N. Noiret, A. Roucoux et al., "New bis (dithiocarbonylato)nitridotechnetium-99m radiopharmaceuticals for leucocyte labelling: in vitro and in vivo studies," *Nuclear Medicine and Biology*, vol. 24, no. 5, pp. 439–445, 1997.
- [29] F. Demaimay, A. Roucoux, N. Noiret, and H. Patin, "The complex [ReOHNN(CH<sub>3</sub>)CS<sub>2</sub>CH<sub>3</sub>]<sub>2</sub>Cl, a suitable precursor for the preparation of bis(dithiocarbamato)nitridorhenium(V) species," *Journal of Organometallic Chemistry*, vol. 575, no. 1, pp. 145–148, 1999.
- [30] F. Mévellec, N. Lepareur, A. Roucoux et al., "Chelated hydrazido(3-)rhenium(V) complexes: on the way to the nitrido-M(V) core (M = Tc, Re)," *Inorganic Chemistry*, vol. 41, no. 6, pp. 1591–1597, 2002.
- [31] N. Lepareur, F. Mévellec, N. Noiret et al., "Syntheses and reactivity of 'sulfur rich' Re(III) and Tc(III) complexes containing trithioperoxybenzoate, dithiobenzoate and dithiocarbamate ligands," *Dalton Transactions*, no. 17, pp. 2866–2875, 2005.

- [32] F. Mévellec, A. Roucoux, N. Noiret, H. Patin, F. Tisato, and G. Bandoli, "Synthesis and characterization of the bis(trithioperoxybenzoate)(dithiobenzoate)rhenium(III) hetero complex," *Inorganic Chemistry Communications*, vol. 2, no. 6, pp. 230–233, 1999.
- [33] F. Mévellec, F. Tisato, F. Refosco et al., "Synthesis and characterization of the 'sulfur-rich' bis(perthiobenzoato)(dithiobenzoato)technetium(III) heterocomplex," *Inorganic Chemistry*, vol. 41, no. 3, pp. 598–601, 2002.
- [34] F. Tisato, M. Porchia, C. Bolzati, F. Refosco, and A. Vittadini, "The preparation of substitution-inert  $^{99m}\text{Tc}$  metal-fragments: promising candidates for the design of new  $^{99m}\text{Tc}$  radiopharmaceuticals," *Coordination Chemistry Reviews*, vol. 250, no. 15–16, pp. 2034–2045, 2006.
- [35] F. Mévellec, A. Roucoux, N. Noiret, A. Moisan, H. Patin, and A. Duatti, "Synthesis and characterization of new  $^{99m}\text{Tc}$ -radiopharmaceuticals with dithiobenzoate derivatives for the study of septic inflammatory processes," *Journal of Labelled Compounds and Radiopharmaceuticals*, vol. 46, no. 4, pp. 319–331, 2003.
- [36] E. Garin, N. Noiret, C. H. Malbert et al., "Development of  $^{99m}\text{Tc}$  labelled Lipiodol: biodistribution following injection into the hepatic artery of the healthy pig," *Nuclear Medicine Communications*, vol. 25, no. 3, pp. 291–297, 2004.
- [37] N. Lepareur, E. Garin, N. Noiret, and J. Y. Herry, "A kit formulation for the labelling of lipiodol with generator-produced  $^{188}\text{Re}$ ," *Journal of Labelled Compounds and Radiopharmaceuticals*, vol. 47, no. 12, pp. 857–867, 2004.
- [38] A. Boschi, C. Bolzati, L. Uccelli, and A. Duatti, "High-yield synthesis of the terminal  $^{188}\text{Re}=\text{N}$  multiple bond from generator-produced [ $^{188}\text{ReO}_4$ ]," *Nuclear Medicine and Biology*, vol. 30, no. 4, pp. 381–387, 2003.
- [39] E. Garin, B. Denizot, N. Noiret et al., " $^{188}\text{Re}$ -SSS lipiodol: radiolabelling and biodistribution following injection into the hepatic artery of rats bearing hepatoma," *Nuclear Medicine Communications*, vol. 25, no. 10, pp. 1007–1013, 2004.
- [40] N. Lepareur, V. Ardisson, N. Noiret et al., "Automation of labelling of Lipiodol with high-activity generator-produced  $^{188}\text{Re}$ ," *Applied Radiation and Isotopes*, vol. 69, no. 2, pp. 426–430, 2011.
- [41] M. Andreeff, G. Wunderlich, K. Behge, T. Schönmath, and J. Kotzerke, " $\beta$ -radiation exposure with  $^{188}\text{Re}$ -labelled pharmaceuticals," *NuklearMedizin*, vol. 44, no. 3, pp. 94–98, 2005.
- [42] N. Lepareur, S. Laffont, V. Ardisson, N. Noiret, and E. Garin, "Reduction of  $\beta$ -radiation exposure during preparation of  $^{188}\text{Re}$ -labelled Lipiodol for hepatocellular carcinoma treatment," *Nuclear Medicine Communications*, vol. 33, no. 2, pp. 205–208, 2012.
- [43] E. Garin, Y. Rolland, L. Lenoir et al., "Utility of quantitative  $^{99m}\text{Tc}$ -MAA SPECT/CT for  $^{90}\text{yttrium}$ -labelled microsphere treatment planning: calculating vascularized hepatic volume and dosimetric approach," *International Journal of Molecular Imaging*, vol. 2011, Article ID 398051, 8 pages, 2011.
- [44] E. Garin, N. Noiret, C. Malbert et al., "Development and biodistribution of  $^{188}\text{Re}$ -SSS lipiodol following injection into the hepatic artery of healthy pigs," *European Journal of Nuclear Medicine and Molecular Imaging*, vol. 31, no. 4, pp. 542–546, 2004.
- [45] Z. Kan, K. Ivancev, I. Hagerstrand, V. P. Chuang, and A. Lunderquist, "In vivo microscopy of the liver after injection of Lipiodol into the hepatic artery and portal vein in the rat," *Acta Radiologica*, vol. 30, no. 4, pp. 419–425, 1989.
- [46] E. Garin, B. Denizot, J. Roux et al., "Description and technical pitfalls of a hepatoma model and of intra-arterial injection of radiolabelled lipiodol in the rat," *Laboratory Animals*, vol. 39, no. 3, pp. 314–320, 2005.
- [47] E. Garin, H. Rakotonirina, F. Lejeune et al., "Effect of a  $^{188}\text{Re}$ -SSS lipiodol/ $^{131}\text{I}$ -lipiodol mixture,  $^{188}\text{Re}$ -SSS lipiodol alone or  $^{131}\text{I}$ -lipiodol alone on the survival of rats with hepatocellular carcinoma," *Nuclear Medicine Communications*, vol. 27, no. 4, pp. 363–369, 2006.