



**HAL**  
open science

## Performance analysis of both WIMAX and LTE technologies

Shuai Ma

► **To cite this version:**

| Shuai Ma. Performance analysis of both WIMAX and LTE technologies. 2013. hal-00861079

**HAL Id: hal-00861079**

**<https://hal.science/hal-00861079>**

Submitted on 11 Sep 2013

**HAL** is a multi-disciplinary open access archive for the deposit and dissemination of scientific research documents, whether they are published or not. The documents may come from teaching and research institutions in France or abroad, or from public or private research centers.

L'archive ouverte pluridisciplinaire **HAL**, est destinée au dépôt et à la diffusion de documents scientifiques de niveau recherche, publiés ou non, émanant des établissements d'enseignement et de recherche français ou étrangers, des laboratoires publics ou privés.

# Master MDM Internship

## Performance analysis of both WIMAX and LTE technologies

Shuai MA

Supervisor :Salima Hamma

Academic year: 2012/2013

Laboratory:IRCCyN/IVC



Abstract.....	4
1 WiMAX technology.....	5
1.1 Introduction of WiMAX.....	5
1.2 PHY layer in WiMAX.....	6
1.2.1 OFDM.....	6
1.2.2 OFDMA.....	7
1.2.3 Antenna Techniques.....	9
1.2.4 Physical Channelization.....	10
1.3 MAC layer in WiMAX.....	11
1.4 Quality of Service in WiMAX.....	11
1.4.1 Channel-Unaware Schedulers.....	13
1.4.2 Channel-Aware Schedulers.....	14
2 LTE technology.....	16
2.1 Introduction of LTE.....	16
2.2 PHY layer in LTE.....	17
2.2.1 OFDMA and SC-FDMA.....	17
2.2.2 Multiple Antenna Techniques.....	18
2.2.3 Physical Channelization.....	18
2.3 MAC Layer in LTE.....	19
2.4 Quality of Service in LTE.....	20
2.4.1 Scheduling.....	21
2.4.2 Channel-unaware schedulers.....	21
2.4.3 Channed-aware schedulers.....	22
2.4.4 Semi-persistent Scheduling for VoIP support schedulers.....	22
2.4.5 Energy-aware schedulers.....	22
3.Comparision between WiMAX and LTE.....	23
3.1 Architecture.....	23
3.2 Frame structure.....	27
3.3 MIMO technology.....	28
3.4 MAC Layer.....	28
3.5 Multiple Access Technology.....	31
3.6 QoS.....	32
4 Connection Admission Control algorithm (CAC) and Two-Level Scheduling Algorithm(TLSA).....	33
4.1 Pre-processor.....	33
4.2 Queue Management.....	34
4.3 Traffic policing.....	34
4.4 Connection Admission Contrlo(CAC).....	34
4.5 Two-Level Scheduling Algorithm.....	35
4.5.1 Inter-Class Scheduling.....	35
4.5.2 Intra-Class Scheduling.....	36
5 Simulation of Two-level scheduling algorithm in QualNet.....	38
5.1 QualNet Introduction.....	39
5.1.1 QualNet Architecture.....	40

5.1.2 Scenario-based Network Simulation.....	41
5.1.3 General Approach.....	41
5.1.4 Files Associated with a Scenario.....	41
5.2 Implementation of TLSA in QualNet.....	42
5.2.1 Noise factor.....	42
5.2.2 Fading factor.....	43
5.2.3 Shadowing factor.....	45
5.3 Analyse of the simulation.....	45
6. Conclusion.....	50
Reference.....	51

## ABSTRACT

Nowadays, mobile communication has become the most potential with great demand technology in the field of communication. It has been through three main parts in the history. The first generation is from 80s in the 20<sup>th</sup> century, simulation and Frequency Division Multiple Access (FDMA) technology was mainly used in that time. Then the second generation (2G) originated in the early period of 90s, Time Division Multiple Access (TDMA) and Code Division Multiple Access (CDMA) technology became the leading role at that time. After that the third generation could offer wider frequency band comparing to the first two generation. With this new technology, not only voice can be transmitted, but also data with a high speed.

Although the third generation mobile communication standard is more powerful than existing wireless technologies, it also faces competition, incompatible standards and other issues. Therefore, the research of the fourth generation mobile communication systems (4G) comes into being. The 4G should obtain more advantages in communication range, quality and any other aspects than the former communication technology. Meanwhile, the new generation is supposed to have some features such as high speed, high flexibility and high compatibility.

Two emerging technologies, the IEEE 802.16 WiMAX(Worldwide Interoperability for Microwave Access) and the 3GPP LTE(Third Generation Partnership Project Long Term Evolution) purpose to meet the requirements of 4G standards and provide mobile voice, video and data services by promoting low cost deployment and service models through Internet friendly architectures and protocols. Both of them are being considered as candidates for the 4G mobile networks.

In chapter 1 and 2 of this paper, we present the overview for the WiMAX and LTE technology respectively through their physical layer and MAC layer structure. Then we introduce the QoS mechanism of them which are an important part of these two technologies. The comparison of WiMAX and LTE in architecture, frame structure, multiple access technology and other features is shown in chapter 3. In chapter 4, a two-level scheduling algorithm (TLSA) for the base station uplink scheduler which is a channel-unaware algorithm in WiMAX is provided. At the end, we use a simulation tool which is QualNet to test the performance of this scheduling algorithm when the physical channel condition changes in chapter 5. Here three parameters such as noise factor, fading factor and shadowing factor are used in this experiments. We offer the analysis of the experiment finally.

# 1. WiMAX technology

## 1.1 Introduction of WiMAX

IEEE 802.16 is a set of telecommunications technology standards aimed at providing wireless access over long distances in a variety of ways --from point-to-point links to full mobile cellular type access. It is also called Wireless MAN which can cover a metropolitan area of several kilometers.

WiMAX(Worldwide Interoperability for Micro Wave Access) is a wireless communications standard which was years in the making, was finalized in June 2004.It is made by WiMAX Forum which is a group of 400+ networking equipment vendors, service providers, component manufacturers and users that decide which of the numerous options allowed in the IEEE 802.16 standards should be implemented so that equipment from different vendors will inter-operate. WiMAX is designed to provide 30 to 40 megabit-per-second data rates, with the 2011 update providing up to 1Gbit/s for fixed stations. The most popular description of WiMAX is "a standards-based technology enabling the delivery of last mile wireless broadband access as an alternative to cable and DSL".

WiMAX offers a point-to-point range of 30 miles (50 km) with a throughput of 72 Mbps while supporting a non-line-of-sight (NLOS) range of 4 miles and, in a point-to-multipoint distribution, the model can distribute nearly any bandwidth to almost any number of subscribers, depending on subscriber density and network architecture. WiMAX will enable an improved standard of living in the form of telecommuting, lower real estate prices, and improved family lives.

Since WiMAX is one of the wireless forms of Ethernet, much of the Open Systems Interconnection (OSI) Reference Model applies. Here we focus on the physic layer and MAC layer mostly.

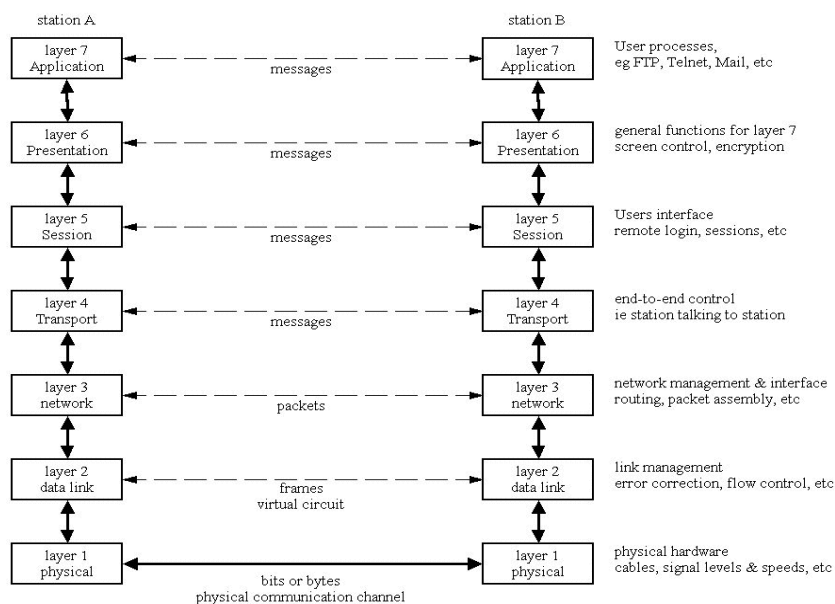

OSI Reference Model

## 1.2 PHY layer in WiMAX

The purpose of the physical layer is the physical transport of data. The existed technology of PHY includes orthogonal frequency division multiplexing (OFDM), time division duplex (TDD), frequency division duplex (FDD), Quadrature Phase Shift Keying (QPSK), and Quadrature Amplitude Modulation (QAM)<sup>[1]</sup>.

In the IEEE 802.16 standard, it defines 5 ways to achieve the goal of transmitting for PHY layer which are the WMAN-SC, the WMAN-SCA, WMAN-OFDM, WMAN-OFDMA and WirelessHUMAN.

### 1.2.1 OFDM

WiMAX is designed to deliver maximum throughput to maximum distance in the condition of offering most close to the perfect reliability. The WiMAX physical layer is based on orthogonal frequency division multiplexing. OFDM is a transmission scheme which can enable high-speed data, video, as well as multimedia communications while it is used by DSL, Digital Video Broadcast-Handheld (DVB-H) and MediaFLO other than WiMAX. OFDM is an efficient scheme which can make high data rate transmission in a non-line-of-sight or multipath radio environment.

OFDM is a member of multicarrier modulation which is a set of transmission schemes. It is created by the idea of dividing a given high-bit-rate data stream into many parallel lower bit-rate streams and modulating each stream on separate subcarrier. Multicarrier modulation schemes eliminate or minimize intersymbol interference (ISI) by making the symbol time large enough so that the channel-induced delays—delay spread being a good measure of this in wireless channels—are an insignificant (typically, <10 percent) fraction of the symbol duration. In high-data-rate systems in which the symbol duration is small, being inversely proportional to the data rate, splitting the data stream into many parallel streams increases the symbol duration of each stream such that the delay spread is only a small fraction of the symbol duration. The OFDM signal representation in frequency and time domain is shown as follows.

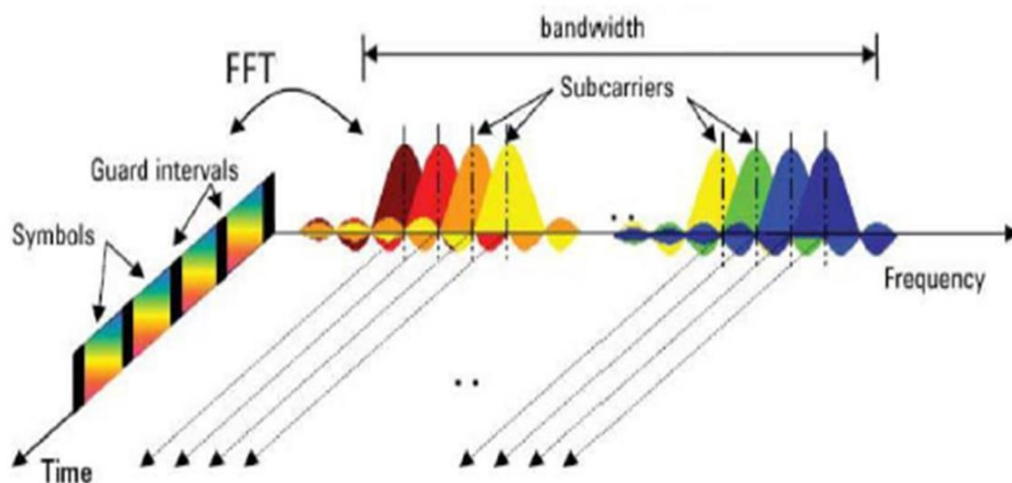

OFDM is a more efficient use of the spectrum and enables the channels to be processed at the receiver more efficiently. OFDM is especially popular in wireless applications because of its resistance to forms of interference and degradation.

The subcarriers of OFDM are selected based on the strategy that they must be orthogonal to all the others over the symbol duration. In this way, it can avoid the need of having nonoverlapping subcarrier channels to eliminate intercarrier interference. The OFDM process can be decomposed into a six steps.

- (1) User signal enters transmitter in serial type in the beginning. These codewords are sent to a staticizer first, then they are transmitted after assigning to several low-rate subchannels relatively via the serial / parallel conversion. Where channel is divided into several orthogonal subchannels which has its own subcarrier to modulate separately.
- (2) The OFDM code is sent to an inverse fast Fourier transform (IFFT) module to make the inverse fast Fourier transform.
- (3) A protection interval is added to the sample which forms the OFDM information codes of a loop expanding after calculating the inverse fast Fourier transform.
- (4) The sample values of loop expanding information codes go through a serializer module again. Then they enter the channel by the way of the serial channel (after appropriate filtering and modulation). OFDM codes are transmitted after ending the parallel-to-serial process.
- (5) The receiving signal goes through a staticizer while removing the protection interval.
- (6) The signal will pass through a fast Fourier transform module while it is converted from the time domain to the frequency domain. Afterwards, the reception of the original OFDM signal is completed with the process of parallel-to-serial in a serializer.

#### OFDM advantages and challenges

There are some advantages of using OFDM technology in PHY layer which are the spectrum utilization is very high; the ability of anti-multipath interference and frequency selective fading is strong; dynamic subcarrier allocation techniques will enable the system to achieve the maximum bit rate; OFDM is excellent in anti-fading with the joint coding of each sub-carrier; OFDM uses a fast Fourier transform (FFT) and inverse fast Fourier transform (IFFT) to realize the modulation and demodulation which is easy to use digital signal processor (DSP) to achieve. There are also some challenges for OFDM technology. First, OFDM signal has a high peak-to-average ratio which can create nonlinearities and clipping distortion. It can decrease the power efficiency. Second, OFDM signals are very susceptible to phase noise and frequency dispersion, and the design must mitigate these imperfections. As a result, accurate frequency synchronization is important in this region.

#### 1.2.2 OFDMA

Orthogonal frequency division multiple access (OFDMA) is a multi-user version of the popular orthogonal frequency-division multiplexing (OFDM) digital modulation scheme. Multiple access is achieved in OFDMA by assigning subsets of subcarriers to individual users. This allows simultaneous low data rate transmission from several users.



In OFDMA mode, the activated subcarrier is divided into several subsets, and each subset is called a subchannel. In the downlink side, one subchannel can be assigned to different receiver. In the uplink side, a transmitter can assign to one or more subchannel, and a number of transmitters can deliver simultaneously. A plurality of subcarriers to form a subchannel can be adjacent or not adjacent. Each OFDMA symbol is divided into logical sub-channels in order to support scalability, multiple access and advanced antenna array processing capabilities. Here is a figure that OFDMA transmitting a series of QPSK data symbols.

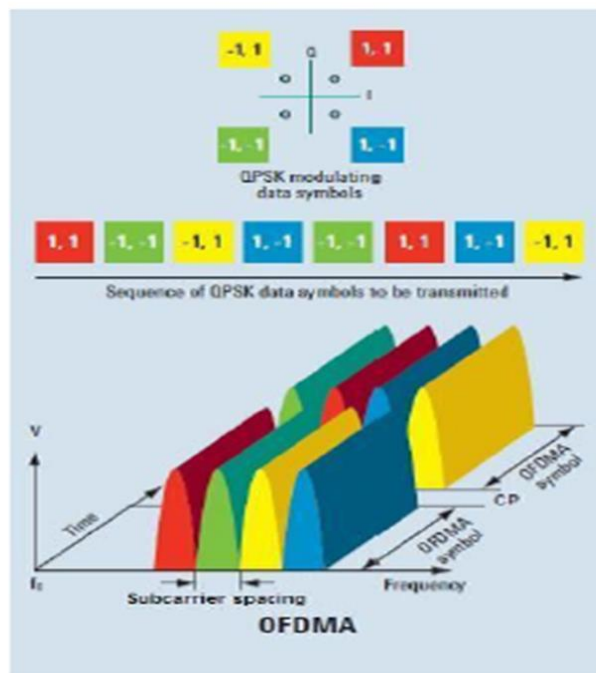

The main advantages of OFDMA systems are : a variable bandwidth OFDMA is able to balance the anti-multipath ability and Doppler effect; variable bandwidth OFDMA system design can be simplified by using the same symbol width and the sub-carrier spacing; support variable bandwidth support by scalable structural can be from 1.25 MHz to 20MHz;flexible subchannel allocation, pseudo-random subchannel can increase diversity; arranging subchannels continuously can increase multi-user selective;multi-user access ensures orthogonal which can reduce the interference and increase capacity; accurate bandwidth allocation. The difference of the subcarrier allocation between OFDM and OFDMA is presented below.

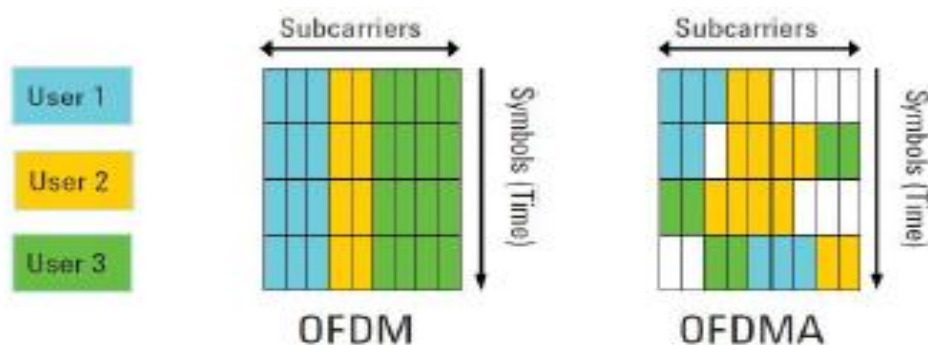

### 1.2.3 Antenna Techniques

The antenna technique is very important in any radio transmission. Nowadays, there are some kinds of Multiple Antenna Techniques such as SISO(single input single output), MISO(multiple input single output), SIMO(single input multiple output), MIMO(multiple input multiple output). The usage of multiple antenna techniques make a big breakthrough of improving the signal robustness and increasing the system capacity as well as user data in the case of spatial diversity of the radio channel. The figure of antenna techniques is presented below.

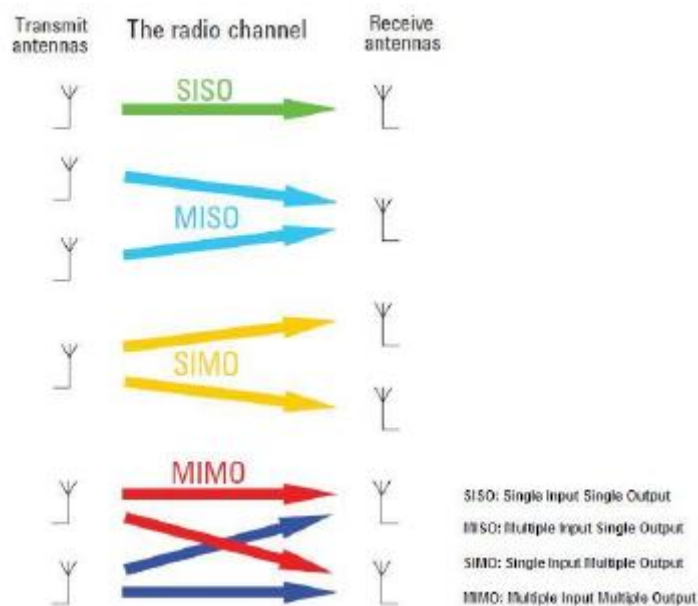

Multiple-input multiple-output (MIMO) techniques have been extensively adopted in the IEEE 802.16d/e/j standards to improve both the cell coverage and average user experience<sup>[1]</sup>. Examples of MIMO techniques include single-user MIMO (SU-MIMO), multiuser MIMO (MU-MIMO), and cooperative relay. These new techniques allow flexible link configurations including both point-to-multipoint and multipoint-to-point. For example, a base station (BS) employing spatial division multiple access (SDMA) can send multiple data streams to multiple subscriber stations (SSs) simultaneously on the same time-frequency resource, while multiple relay stations (RSs) can cooperatively perform space-time coding to send data packets to one SS. However, each MIMO technique is optimized for only a limited set of application scenarios. For example, transmit beamforming requires channel state information at the transmitter (CSIT) and thus does not perform well in high-mobility situations. The support of MIMO techniques also brings additional requirements and constraints in system design and integration. Additional pilots for channel training, for example, are required for the multiple transmit antennas in diversity modes. In addition, the adoption of MIMO techniques often requires a tight design integration of PHY, medium access control (MAC), and higher layers. Besides technical issues, cost plays an important role for wider market penetration. Low-cost solutions such as antenna selection may be appealing to certain markets.

Adaptive Antenna System is used in the WiMAX specification to describe beam-forming techniques where an array of antennas is used at the BS to increase gain to the intended SS while nulling out interference to and from other SSs and interference sources<sup>[2]</sup>. AAS techniques can be used to enable Spatial Division Multiple Access (SDMA), so multiple SSSs that are separated in space can receive and transmit on the same subchannel at the same time. By using beam forming, the BS is able to direct the desired signal to the different SSs and can distinguish between the signals of different SSs, even though they are operating on the same subchannel(s)

### 1.2.4 Physical Channelization

In WiMAX, the data to be transmitted is mapped to one or more logical sub-channels called slots which is controlled by the scheduler. And the logical sub-channels are mapped to physical subcarriers. The physical data and pilot subcarriers are uniquely assigned based on the type of sub-channelization used. They are formed by two types of subcarrier allocations which are distributed allocation and adjacent allocation. For distributed allocation, it pseudo-randomly distributes the subcarriers over the available bandwidth thus providing frequency diversity in frequency selective fading channels and inter-cell interference averaging. On the other hand, for adjacent allocation, they are adjacent to each other in the frequency domain. Contiguous symbols that use specific type of sub-channel assignment are called permutation zones. Here the zone types used for downlink and uplink are as follows.

Zone types	Full names	Functions
DL PUSC	Downlink Partial Usage of Sub-channels	Marking the start of all DL frames following the preamble and being mapped into larger groups.
UL PUSC	Uplink Partial Usage of Sub-channels	Four contiguous subcarriers are grouped over three symbols to form a tile.
DL FUSC	Downlink Full Usage of Sub-channels	Using all subcarriers to provide a high degree of frequency diversity.
DL OFUSC	Downlink Optional FUSC	A slight variation of FUSC where pilot subcarriers are evenly spaced by eight data subcarriers.
UP OPUSC	Uplink Optional PUSC	Same as UL PUSC except using a tile size
TUSC1 and TUSC2	Tile Usage of Sub-channels	Similar to DL PUSC and OPUSC except using a different equation for assigning the subcarriers.

### 1.3 MAC layer in WiMAX

WiMAX MAC layer provides an interface between the higher transport layers and the physical layer. It takes MAC service data units (MSDUs) from upper layer and then organizes them into MAC protocol data units (MPDUs) for transmission over the air. MAC layer does the reverse in the receiving side. The greatest value of it is to provide for dynamic bandwidth allocation that defeats the usual degradations of wireless services which are latency and jitter.

The WiMAX MAC layer is designed from the ground up to support very high peak bit rates while delivering quality of service similar to that of ATM and DOCSIS. The WiMAX MAC layer uses a variable-length MPDU and offers a lot of flexibility to allow for their efficient transmission. The WiMAX MAC protocol is for point-to-multipoint broadband wireless access applications while it addresses the need for very high bit rates, both UL (to the BS) and DL (from the BS). The WiMAX MAC accommodates both continuous and bursty traffic for the legacy TDM voice and data, IP connectivity, and packetized VoIP require services of end users. Meanwhile, the WiMAX MAC protocol supports a variety of backhaul requirements including both ATM and packet-based protocols.

The WiMAX MAC layer includes three components which are the service-specific convergence sublayer (CS), the common-part sublayer, and the security sublayer. The function of the CS is to get data packets from the high layer while its location is between the MAC layer and layer 3 of the network. The CS should perform all operations that are dependent on the nature of the higher-layer protocol. It can be trained as a layer which can mask the higher-layer protocol and its requirements from the rest of the WiMAX MAC and PHY layers. The common-part sublayer performs all the packet operations that are independent of the higher layers. Obviously the security sublayer is to make sure encryption, authorization, and proper exchange of encryption keys between the BS and the SS.

### 1.4 Quality of Service in WiMAX

There are two broad definitions of Quality of Service (QoS)<sup>[3]</sup>:

User-Centric QoS is the collective effect of service performances which determine the degree of satisfaction of a user of the service.

Network-Centric QoS is the mechanisms that give network managers the ability to control the mix of bandwidth, delay, variances in delay (jitter), and packet loss in the network in order to deliver a network service (e.g., voice over IP). Here we focus on the second QoS which are Network-Centric QoS.

Users insist on a transmission protocol that controls contention between themselves and enables the service to be tailored to the delay and bandwidth requirements of each user application. This is accomplished through four different types of UL scheduling mechanisms. These mechanisms are implemented using unsolicited bandwidth grants, polling, and contention procedures. The WiMAX MAC provides QoS differentiation<sup>[4]</sup> for different types of applications that might

operate over WiMAX networks:

**Unsolicited Grant Service :** The Unsolicited Grant Service, UGS is used for real-time services such as Voice over IP, VoIP or for applications where WiMAX is used to replace fixed lines such as E1(E-carrier system) and T1(T-carrier).

**Real-time Packet Services :** This WiMAX QoS class is used for real-time services including video streaming. It is also used for enterprise access services where guaranteed E1/T1 rates are needed but with the possibility of higher bursts if network capacity is available. This WiMAX QoS class offers a variable bit rate but with guaranteed minimums for data rate and delay.

**Extended Real Time Packet Services :** This WiMAX QoS class is referred to as the Enhanced Real Time Variable Rate, or Extended Real Time Packet Services. This WiMAX QoS class is used for applications where variable packet sizes are used - often where silence suppression is implemented in VoIP. One typical system is Skype.

**Non-real time Packet Services :** This WiMAX QoS class is used for services where a guaranteed bit rate is required but the latency is not critical. It might be used for various forms of file transfer.

**Best Effort :** This WiMAX QoS is that used for Internet services such as e-mail and browsing. Data packets are carried as space becomes available. Delays may be incurred and jitter is not a problem.

The scheduling reservation management details are not standardized even though extensive bandwidth allocation and QoS mechanisms are provided . In fact, the standard supports scheduling only for fixed-size real-time service flows. The scheduling of both variable-size real-time and non-real-time connections is not considered in the standard. Thus, WiMAX QoS is still an open field of research and development for both constructors and academic researchers. The standard should also maintain connections for users and guarantee a certain level of QoS. Scheduling is the key model in computer multiprocessing operating system. It is the way in which processes are designed priorities in a queue. Scheduling algorithms provide mechanism for bandwidth allocation and multiplexing at the packet level.

The bandwidth allocation requests are divided into specified class after going through the classifier in subscriber stations. Then the allocation requests combine QoS Parameters are sent to subscriber station scheduler and transmitted to base station considering the channel conditions. At base station, the uplink scheduler decides which request should be accepted and which are going to be abandoned based on uplink scheduling algorithm. The information of it is included into Uplink Map which is given back to the subscriber station. Afterwards, SSs starts to sending their data based on it. With connection admission control and QoS parameters, the base station also make decisions of the priorities of the data which are transmitting back to subscriber stations. All the request and frame are through physical layer. Here is the figure of overall structure of the WiMAX QoS architecture.

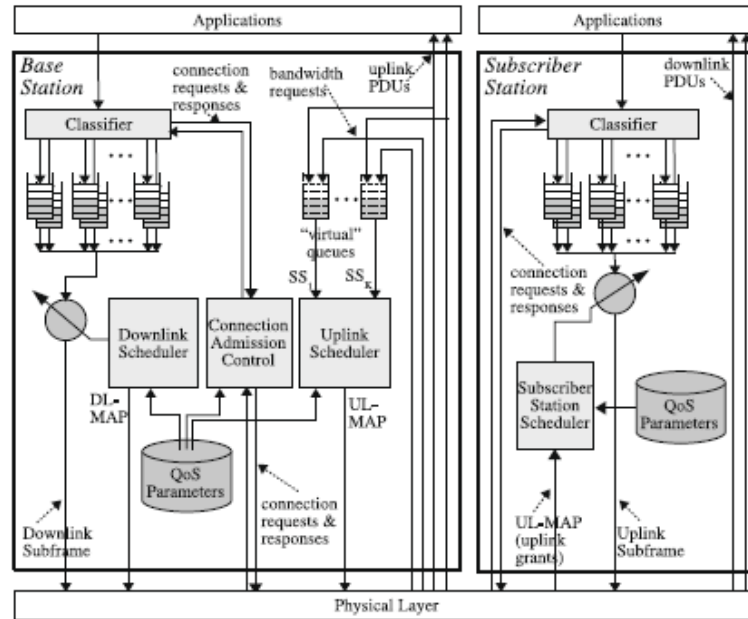

There are many scheduler proposals for WIMAX while most of them focus on the BS scheduler, especially Downlink-BS scheduler. Downlink-BS scheduler can get the information about queue and packets easily. For Uplink-BS scheduler, the polling mechanism has to be considered to guarantee the QoS. It is obvious that splitting the allocation bandwidth among the connections is decided by BS scheduler when the QoS parameter can be assured.

Nowadays, the mainstream scheduling techniques for WiMAX can be divided into two categories which are channel-unaware schedulers and channel-aware schedulers. In details, channel-unaware schedulers do not use the information of the channel conditions in making the scheduling decision while generally assume error-free channel so that it is easier to reach the QoS assurance. For channel-aware schedulers, it is important to consider the signal attenuation, fading, interference and noise effect during the transmission process. It is more wise for scheduler designers to take into account the channel condition in order to optimally and efficiently make the allocation decision.

The schedulers for WiMAX can be classified into two categories which are intra-class scheduling and inter-class scheduling. In details, intra-class scheduling is to allocate the resource within the same class given the QoS requirements. The main issue for inter-class scheduling is whether each traffic class should be considered separately, that is, have its own queue. The channel-unaware schedulers and channel-aware schedulers are going to be presented below.

### 1.4.1 Channel-Unaware Schedulers

This type of schedulers makes no use of channel state conditions such as the power level, channel error and loss rates. These basically assure the QoS requirements among five classes—mainly the delay and throughput constraints<sup>[5]</sup>. Some channel-unaware scheduling are introduced below.

Round Robin(RR) algorithm : Aside from FIFO, RR allocation can be considered the very first

simple scheduling algorithm. RR fairly assigns the allocation one by one to all connections. The fairness considerations need to include whether allocation is for a given number of packets or a given number of bytes. With packet based allocation, stations with larger packets have an unfair advantage.

Earliest Deadling First(EDF) algorithm : EDF belongs to Delay-based algorithms which are a set of schemes is specifically designed for real-time traffic such as UGS,ertPS and rtPS service classes, for which the delay bound is the primary QoS parameter and basically the packets with unacceptable delays are discarded. EDF serves the connection based on the deadline.

Priority-based algorithm(PR) : In order to guarantee the QoS to different classes of service, priority-based schemes can be used in a WiMAX scheduler. For example, the priority order can be : UGS, ertPS, rtPS, nrtPS and BE, respectively.

These algorithm upon is either intra-class scheduling or inter-class scheduling in channel-unaware catalog. Moreover, some schduling designers invent some scheduling algorithms which can combine both inter-class scheduling and intra-class schduling nowadays.

Two-Tier Scheduling Algorithm(2TSA)<sup>[6]</sup> : 2TSA is implemented only at BSs. The objectives are to achieve both QoS guarantee and fairness. The first-tier and second-tier scheduling is category-based and weight-based, respectively. 2TSA first allocates bandwidth to the “unsatisfied” category. While still being with more available bandwidth, it then allocates bandwidth to connections belonging to “satisfied” category, and followed by “over-satisfied” category. Therefore, the first-tier bandwidth allocation is to ensure that each connection can be satisfied with their minimum requirement. Then for a specific category, the received bandwidth is further distributed to connections based on the parameter of weight. The smaller weight of a connection, the higher bandwidth allocation priority it has. After finishing this two-tier bandwidth allocation, the BS generates the corresponding UL-MAP and broadcasts to all.

#### **1.4.2 Channel-Aware Schedulers**

The channel-aware schedulers can be classified into four classes based on the primary objective : fairness, QoS guarantee, system thoughput maximization and power optimization<sup>[11]</sup>. Basically, the BS downlink scheduler can use the Carrier to Interence and Noise Ratio(CINR) which is reported back from the SS via the Channel Quality Indicator(CQI) channel. For uplink scheduling, the CINR is measured directly on previous transmissions from the same subscriber station. Most of the purposed algorithms have the common asumption that the channel condition does not change within the frame period. Also, it is assumed that the channel information is known at both the transmitter and the receiver.

1.Fairness : This metric mainly applies for the Best Effort(BE) service. One of the commonly used baseline shcdulers in published rersearch is the Proportional Fairness Scheme(PFS). The objective of PFS is to maximize the long-term fairness.

2.QoS Guarantee : Modified Largest Weighted Delay First (MLWDF) can provide delays smaller than a predefined threshold value with a given probability for each user (rtPS and nrtPS). And, it is provable that the throughput is optimal for LWDF. The algorithm can achieve the optimal whenever there is a feasible set of minimal rates area. The algorithm explicitly uses both current channel condition and the state of the queue into account.

3.System Throughput Maximization : Some schemes are focus on maximizing the total system throughput. A maximum system throughput approach is the exponential rule in that it is possible to allocate the minimum number of slots derived from the minimum modulation scheme to each connection and then adjust the weight according to the  $\exp(-p)$  of the instant modulation scheme over the minimum modulation scheme. This scheme obviously favors the connections with better modulation scheme (higher  $p$ ). Users with better channel conditions receive exponentially higher bandwidth. Two issues with this scheme are that additional mechanisms are required if the total slots are less than the total minimum. And, under perfect channel conditions, connections with zero minimum bandwidth can gain higher bandwidth than those with non-zero minimum bandwidth.

4.Power Constraint : The purpose of this class of algorithms is not only to optimize the throughput but also to meet the power constraint. In general, the transmitted power at a subscriber station is limited. As a result, the maximum power allowable is introduced as one of the constraints. Least amount of transmission power is preferred for mobile users due to their limited battery capacities and also to reduce the radio interference. Link-Adaptive Large-Weighted-Throughput (LWT) algorithm has been proposed for OFDM systems. LWT takes the power consumption into consideration. The suboptimal Hungarian of Linear Programming algorithm with adaptive modulation is used to find the subcarriers for each user and then the rate for the user is iteratively incremented by a bit loading algorithm, which assigns one bit at a time with a greedy approach to the subcarrier. Since this suboptimal and iterative solution is greedy in nature, the user with worse channel condition will mostly suffer.

Some detailed algorithms of channel-aware are presented below.

TCP-Aware Uplink Scheduling Algorithm<sup>[7]</sup>: This algorithm works with only one class of 4 classes defined for QoS. It deals with BE class. As this class has not any specific QoS requirement it is not advantageous to use bandwidth request mechanism for this class and to waste that bandwidth. Also, it is not advisable to equally allocate remaining bandwidth to all remaining BE connections because all connections can't utilize all bandwidth allocated to them and some may have more requirements than allocated. So, this algorithm works by calculating bandwidth for a particular connection according to sending rate of that connection. Also as sending rate is going to change dynamically, it is not proper to allocate fix amount of bandwidth to a particular connection.

Hierarchical Channel-Aware Uplink Algorithm<sup>[8]</sup>: This scheduling rule is a hierarchical channel aware scheduling algorithm for uplink scenario. Weights of the service classes are adaptive according to the QoS requirements of each service class. Weights of the subscriber stations are



assigned based on their channel quality and bandwidth requests. This algorithm leads to improving overall system throughput without starving lower priority service class.

Intra-Class Channel-Aware Scheduling Algorithm<sup>[9]</sup>: This proposed algorithm uses battery level as a new parameter to determine the weights. It is designed for nrtPS class and belongs to intra class scheduling method. First, the number of subcarriers to be assigned to each other is determined. Afterwards, assign the remaining subcarriers to the users. After calculate the number of subcarriers per each user and user's priority, the author introduced a new priority metric to subcarrier allocation. As a result, according to this metric, users with higher arrival rate in previous frame, lower battery level and long-term throughput has the priority to get service.

## 2. LTE technology

### 2.1 Introduction of LTE

LTE, an initialism of long-term evolution, marketed as 4G LTE, is a standard for wireless communication of high-speed data for mobile phones and data terminals. It is based on the GSM/EDGE and UMTS/HSPA network technologies. It is aiming for maximum 100 Mbps downlink and 50 Mbps uplink speed when using 20 MHz bandwidth so that it can enable diverse mobile multimedia service provision. The standard is developed by the 3GPP which is 3rd Generation Partnership Project.

The basic protocol structure of LTE is made by radio link control(RLC) and medium access control (MAC) layers which are responsible for retransmission handling and multiplexing of data flows. The duty of physical layer is to transmit and modulate the data. The structure of LTE protocol is presented below<sup>[10]</sup>.

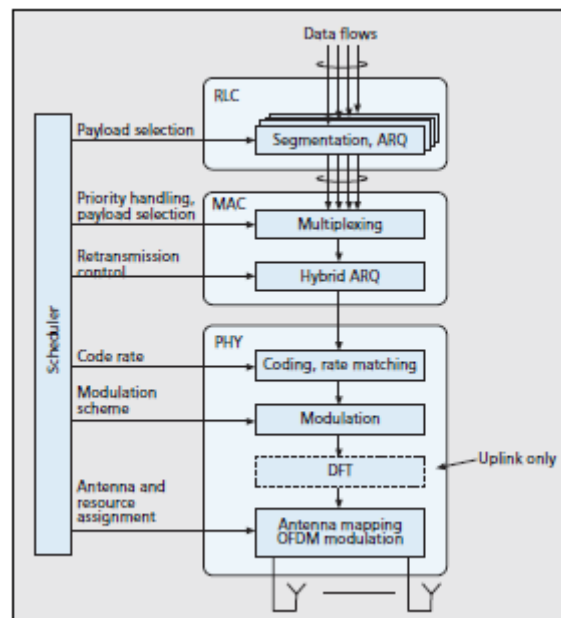

## 2.2 PHY layer in LTE

### 2.2.1 OFDMA and SC-FDMA

LTE systems decides to use OFDMA in its downlike side. However , the situation in its uplink side is kind of different. The fact is that the available transmission power is much lower than it in download side. The highly power-efficient transmission should be considered in the uplink design as well. One single-carrier transmission, based on discrete Fourier transform (DFT)-precod- ed OFDM, sometimes also referred to as single-carrier frequency-division multiple access (SC-FDMA), is used for the LTE uplink.

SC-FDMA<sup>[11]</sup> deals with the assignment of multiple users to a shared communication resource as other multiple access schemes. SC-FDMA can be interpreted as a linearly precoded OFDMA scheme, in the sense that it has an additional DFT processing preceding the conventional OFDMA processing. The process transmission of SC-FDMA scheme is very similar to OFDMA. For each user the sequence of bits transmitted is mapped in a complex constellation symbols (BPSK, QPSK or M-QAM). This different transmitters (users) are assigned different Fourier coefficients. This assignment is carried out in the mapping and demapping blocks. The receiver side includes one demapping block, one IDFT block and one detection block for each user signal to be received. Just like in OFDM , guard intervals with cyclic repetition are introduced between blocks of symbols in view to efficiently eliminate time spreading (caused by multi-path propagation) among the blocks.

In SC-FDMA, multiple access among users is made possible by assigning different users, different sets of non-overlapping fourier-coefficients (sub-carriers). This is achieved at the transmitter by inserting (prior to IFFT) silent fourier-coefficients (at positions assigned to other users), and removing them on the receiver side after the FFT.

Unlike the multi-carrier transmission scheme of OFDMA, the SC-FDMA leads to a single-carrier transmit signal. There are two kinds of subcarrier mapping which are localized mapping and distributed mapping. The mechanism of them is that the DFT outputs are mapped to a subset of consecutive subcarriers so that it can confine them to only a fraction of the system bandwidth in localized mapping while the DFT outputs of the input data are assigned to subcarriers over the entire bandwidth non continuously which can create zero amplitude for the remaining subcarriers in distributed mapping. Here a special case of distributed SC-FDMA is called interleaved SC-FDMA (IFDMA) and occupied subcarriers are equally spaced over the entire bandwidth. The figure of comparison of OFDMA and SC-FDMA transmitting a series of QPSK data symbols is below.

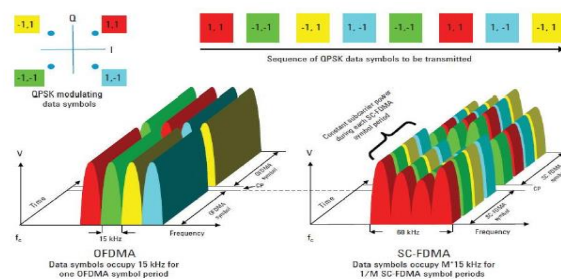

The biggest advantage of SC-FDMA comparing to OFDM is that it can provide robust resistance to multipath without the big problem of high PAR (peak-to-average ratio) which is caused by OFDM technology when the number of subcarriers increase. Although the performance gap is not much. At the same time, frequency-selective fading and phase distortion can be combated since equalization is achieved on the receiver side after the FFT calculation by multiplying each Fourier coefficient by a complex number.

### 2.2.2 Multiple Antenna Techniques

Three multiple antenna schemes can be used which are Tx diversity(MISO), Rx diversity(SIMO), Spatial Multiplexing (MIMO) for LTE downlink side.

For Tx diversity, it supports open-loop configuration other than closed-loop Tx diversity which is more complicated. For Rx diversity, it is mandatory for LTE User Equipment (UE) while making of the baseline receiver capability. The SNR(Signal-to-Noise-Ratio) is improved by maximum ratio combining of received streams. For Spatial Multiplexing (MIMO), LTE uses the two or four antenna configurations. A two channel UE receiver allows 2x2 or 4x2 MIMO, common being the 2x2 Single-User MIMO(SU-MIMO) for LTE. In SU-MIMO, the payload data is made by two code word streams while each code word is represented at different powers and phases on both antennas. Here the closed-loop form of MIMO with pre-coding of streams that channel information can be acquired on the uplink control channel of the UE is used.

For LTE uplink side, battery power and cost must be considered for the LTE User Equipment(UE). MU-MIMO(Multiple-User Multiple Input Multiple Output) where two different UE transmit in the same frequency and time to the eNB is used here. This configuration has the advantage to obtain double the uplink capacity without extra costs to UE. In addition, a second transmit antenna can be allowed to use uplink Tx diversity and SU-MIMO to enable higher data rates depending on channel conditions by the UE. For the eNB, Rx diversity is the baseline capability and LTE supports two or four receive antennas.

### 2.2.3 Physical Channelization

The physical signals are generated in the Layer 1 and used for system synchronization, cell identification and radio channel estimation. Meanwhile, the function of physical channels is to provide a means of carrying data from higher layers which are control, scheduling and user payload. The details of them are presented below.

DL Signals	Full name	Function
P-SCH	Primary Synchronization signal	Cell search and identification by UE. Carries part of cell ID.
S-SCH	Secondary Synchronization signal	Cell search and identification by UE. Carries remainder of cell ID.
RS	Reference Signal(Pilot)	DL channel estimation. Exact

		sequence derived from cell ID.
--	--	--------------------------------

UL Signals	Full name	Function
RS	Reference Signal(Demodulation and sounding)	Used for synchronization to the UE and UL channel estimation.

DL Channels	Full name	Function
PBCH	Physical broadcast channel	Carries cell-specific information
PMCH	Physical multicast channel	Carries the MCH transport channel
PDCCH	Physical downlink control channel	Scheduling, ACK/NACK
PCFICH	Physical control format indicator channel	Defines number of PDCCH OFDMA symbols per sub-frame(1,2,or 3)
PDSCH	Physical downlink shared channel	Payload
PHICH	Physical hybrid ARQ indicator channel	Carries HARQ ACK/NACK

UL Channels	Full name	Function
PRACH	Physical random access channel	Call setup
PUCCH	Physical uplink control channel	Scheduling,ACK/NACK
PUSCH	Physical uplink shared channel	Payload

### 2.3 MAC Layer in LTE

The main functions of MAC Layer in LTE are mapping between transparent and logical channels, error correction through hybrid ARQ, priority handling with dynamic scheduling and logical channel prioritization.

MAC layer of LTE divided into two planes : user plane and control plane. User planes includes Packet Data Convergence Protocol sublayer(PDCP), Radio Link Control sublayer(RLC) and MAC sublayer. Their functions are data header compression, encryption, Automatic Repeat Request(ARQ) and Hybrid ARQ(HARQ). Control plane contains Radio Resource Control sublayer(RRC), PDCP sublayer, RLC sublayer and MAC sublayer. PDCP sublayer offers the protection of encryption and integrity. The function of RLC and MAC layers are the same as they are in the user plane. RRC sublayer provides broadcasting, paging, RLC connection management, radio bearer control, mobility, UE measurement reporting and control functions. Normally, PDCP sublayer, RLC sublayer and MAC sublayer are call L2 layer in LTE.

Radio Resource Control(RRC)

RRC is the key component in radio resource management of E-UTRAN. The main functions of RRC are broadcasting system information, paging, establishment, maintenance and release the RRC connection between terminal and E-UTRAN; security and key management; establishment, maintenance and release point-to-point radio bearer; mobility management including measurement control, reporting, switching, cell selection and reselection and RRC context switching transmission; broadcasting MBMS service; establishment, maintenance and release of MBMS radio bearer; QoS management; terminal measurement control and reporting; operating parameter configuration of the underlying layer.

#### Packet Data Convergence Protocol(PDCP)

PDCP provides the compression of IP data header, encryption and integrity protection of transforming data. The IP data header mechanism is based on Robust Header Compression(ROHC) technique. At the receiving side, PDCP is responsible for the decryption and decompression operation. For mobility terminal, each radio bearer configures a PDCP entity.

#### Radio Link Control(RLC)

RLC is responsible for segmentation / restructuring, retransmission processing and sequential transmission. RLC provide services to PDCP by the way of radio bearer. Each radio bearer has only one RLC entity.

#### MAC

MAC is to deal with HARQ, uplink and downlink scheduling. For uplink and downlink, each cell only has one MAC entity. There are HARQ parts in both sending and receiving sides of MAC. MAC offers service to RLC layer by logical way.

### **2.4 Quality of Service in LTE**

The QoS level of granularity in the LTE evolved packet system (EPS) is bearer which is a packet flow established between the packet data network gateway(PDN-GW) and the user terminal. The traffic running between a particular client application and a service can be differentiated into separate service data flows(SDFs). Here SDFs mapped to the same bearer will get a common QoS treatment. A bearer is assigned a scalar value referred to as a QoS class identifier (QCI) which specifies the class to which the bearer belongs. QCI refers to a set of packet forwarding treatments preconfigured by operator for each network element. The class-based method improves the scalability of the LTE QoS framework.

There are two types of bearers<sup>[12]</sup>:

Guaranteed bit rate (GBR): Dedicated network resources related to a GBR value associated with the bearer are permanently allocated when a bearer becomes established or modified.

Non-guaranteed bit rate (non-GBR): A service utilizing a non-GBR bearer may experience congestion-related packet loss.

GBR bearers are provisioned in the sense that their bandwidth requirements are checked against the current cell utilisation before allowing or disallowing the connection to be formed. Non-GBR bearers have no guaranteed allocation of resources and hence provide a best-effort service.

#### **2.4.1. Scheduling**

For Uplink MAC Scheduling, it determines which bearers get how much of the allocation at the UE, essentially within-UE scheduling. It works on grants received from the eNB. Here MAC tells RLC to send  $X_i$  bits from logical channel  $i$  while scheduler is based on Bearer's QoS requirements.

For Downlink Scheduling at the eNB, it is significantly more complex than at UEs. eNB controls channel usage in both UL and DL. There are some factors affecting scheduling which are: Traffic volume for each bearer at each UE and it schedules UEs with bearers having backlog, QoS Requirements of each bearer at each UE, Radio conditions at UEs which are identified through measurements made at the eNB and reported by the UE.

LTE systems use multi-user scheduling for it changes in the range of distributing available resources among active users so that QoS needs can be achieved.

The portions of the spectrum should be distributed each TTI(transmission time interval) among them since the data channel is shared among the users. The scheduler performs the allocation decision valid for the next TTI and sends such information to UEs while using the PDCCH for each TTI. OFDMA can provide no inter-channel interference so that schedulers of eNB can be deployed. They work with a granularity of one TTI and one RB(resource block) in the time and frequency domain, respectively.

There are some attributes to be considered when the allocation strategies designed which are complexity and scalability, spectral efficiency, fairness and QoS provisioning. Meanwhile, several aspects of LTE deployment in real environment may have effect on the decision to make the best allocation strategies as uplink limitations, control overhead, limitations on the multi-user diversity gain, energy consumption.

Four groups of strategies are made for the allocation of LTE which differ in terms of input parameters, objectives and service targets.

#### **2.4.2. Channel-unaware schedulers**

Based on the assumption of time-invariant and error-free transmission media. There are some channel-unaware algorithms such as First In First Out Algorithm, Round Robin Algorithm, Blind

Equal Throughput Algorithm and Weighted Fair Queuing Algorithm.

### 2.4.3. Channel-aware schedulers

Channel State Information (CSI) feedbacks can be periodically sent from UEs to eNB by using ad hoc control messages. The scheduler can estimate the channel quality perceived by each UE. QoS differentiation is handled by associating a set of QoS parameters to each flow. The scheduler can deal with data to guarantee some minimum required performances in the case of knowing the values of such parameters. The maximum achievable throughput can be predicted as a result. First Maximum Expansion which is to assign resources starting from the highest metric values and “expanding” the allocation on both sides of M. Each UE is considered served whenever another UE having better metric is found.

### 2.4.4. Semi-persistent Scheduling for VoIP support schedulers

Semi-persistent allocation aims at increasing the VoIP capacity of the network in terms of maximum number of contemporary supported VoIP calls. They are not specifically conceived for improving spectral efficiency or for reducing packet delay. They can be considered in practice as channel-unaware approaches.

### 2.4.5. Energy-aware schedulers

Energy saving solutions can be applied to both eNB and UE. For what concern end-user devices, power consumption can be limited through DRX procedures and the persistent allocation, which is at the present the only allocation strategy able to meet this goal.

Some detailed algorithms of LTE are presented as follows.

Adaptive Transmission Bandwidth (ATB) PS algorithm<sup>[13]</sup>: The main motivation for integrating the ATB into the PS functionality is not only the simplification of the RRM functionalities but mostly the need of providing a more flexible algorithm which can accommodate for different traffic types - e.g. VOIP, which requires a limited bandwidth - as well as UEs with different power capabilities. The advantage of this approach is that no additional functionality is required to tune the bandwidth, that is, the capability of coping with varying traffic loads and power limitations is inbuilt in the algorithm.

Time Domain Packet Scheduling (TDPS) algorithm<sup>[14]</sup>: This GBR-aware packet scheduler is used in TD, which prioritizes the users according to the metric in  $MTD_i = GBR_i/R_i$  giving highest priority to the user which is farthest below its GBR requirement.  $R_i$  is the past average throughput of user  $i$  calculated using exponential average filtering.

MAC Scheduling Scheme for VoIP Traffic Service algorithm<sup>[15]</sup>: The key ideas of this scheme are a VoIP priority mode and its adaptive duration management. Since the VoIP priority mode assigns PRBs first to VoIP calls, it is able to minimize VoIP packet delay and loss, but the adaptive

duration management is able to prevent the overall system performance degradation, which is a possible negative effect of the VoIP priority mode. In our scheme, the duration of VoIP priority mode is dynamically adjusted according to VoIP packet drop rates. As a result, we are able to achieve both the QoS satisfaction and the minimization of the negative effect.

Reference AC algorithm<sup>[16]</sup> : The reference AC algorithm decides to admit a new user if the sum of the GBR of the new and the existing users is less than or equal to a predefined  $R_{max}$  as expressed in  $\sum_{i=1}^K GBR_i + GBR_{new} \leq R_{max}$ , where  $K$  is the number of existing users in the cell. The users in a cell require different amount of resources to fulfil their required GBR as it depends on their radio channel quality. A drawback of the reference AC algorithm is that it treats all the users equally and does not differentiate them based on their channel quality. Furthermore,  $R_{max}$  is a tunable parameter and does not represent the actual average uplink cell throughput, which is time-variant as it depends on the resources allocated to the users and their experienced channel quality.

### **3.Comparision between WiMAX and LTE**

#### **3.1 Architecture**

##### WiMAX

The basic requirements of WiMAX are supports for both fixed and mobile access deployments, unbundling of access, connectivity, and application services to allow access infrastructure sharing and mulple access infrastructure aggregation. The goal of the WiMAX design is to meet theses requirements with getting the biggest the use of open standards and IETF protocols in a simple all-IP architecture<sup>[17]</sup>.

A network reference model(NRM) can explain the baseline WiMAX network architecture. WiMAX uses the technique of both network access providers(NAPs) and network service providers(NSPs). NAP provides WiMAX radio access infrastructure. Meanwhile, NSP supports IP connectivity and services to WiMAX subscribers basing some negotiated service level agreements(SLAs). One NSP can have a relationship with multiple NAPs in one or differrent geographical locations within this network architecture. The WiMAX NRM has severral logical network entities as components such as Subscriber Stations(SSs), an access service network(CSN), a connectivity service network(CSN), their interactions through reference points R1-R8. Here each SS, ASN and CSN possess some functions which are presented below.

Subscriber Station(SS) refers to a generalized equipment set providing connectivity between subscriber equipment and a Base Station in the mobile wireless network.

Access Service Network(ASN) performs various network functions which can provide radio access to the SS. The functions are Layer 2 connectivity to the SS ; Messages transmission of Authentication, Authorization and Accounting(AAA) to the H-NSP(Home NSP) ; Preferred NSP discovery and selection ; Relay functionality for establishing Layer 3 connectivity with SS ; Radio ressource management ; Surport ASN and CSN anchored mobility, paging and location



management as well as ASN-CSN tunneling

The ASN can be implemented as an integrated ASN where all functions are collocated in the same logical entity or it may have a decomposed configuration in which the ASN functions are selectively mapped into two separate nodes as a BS and an ASN gateway(ASN-GW). A decomposed ASN may have one or more BSs with at least one instance of an ASN-GW.

Base Station(BS) is a logical network entity that primarily performs the radio related functions of an ASN interface with the SS. Each BS is associated with one sector with one frequency assignment but may incorporate additional DL and UL scheduler.

ASN gateway(ASN-GW) represents an aggregation of centralized functions related to QoS, security, and mobility management for all the data connections as a logical entity. Meanwhile, it can host functions related to IP layer interactions or with other ASN.

BS and ASN-GW can have one to many or many to one relationship which can support loading balancing and redundancy options.

Connectivity service network(CSN) provides IP connectivity services to WiMAX subscribers and comprises of network elements such as routers, AAA proxy/servers, home agent, user databases and interworking gateways or enhanced network servers to support multicast, broadcast and location based services. CSN has some functions which are IP address management, AAA proxy or server ; QoS policy and admission control based on user subscription profiles ; ASN-CSN tunneling support ; Subscriber billing and interoperator settlement ; Inter-CSN tunneling for roaming ; CSN-anchored inter-ASN mobility ; Connectivity to Internet and managed WIMAX services such as IP multimedia services(IMS), location-based services, peer-to-peer services, and broadcast and multicast services ; Over-the-air activation and provisioning

The WiMAX NRM is illustrated as follows<sup>[17]</sup>.

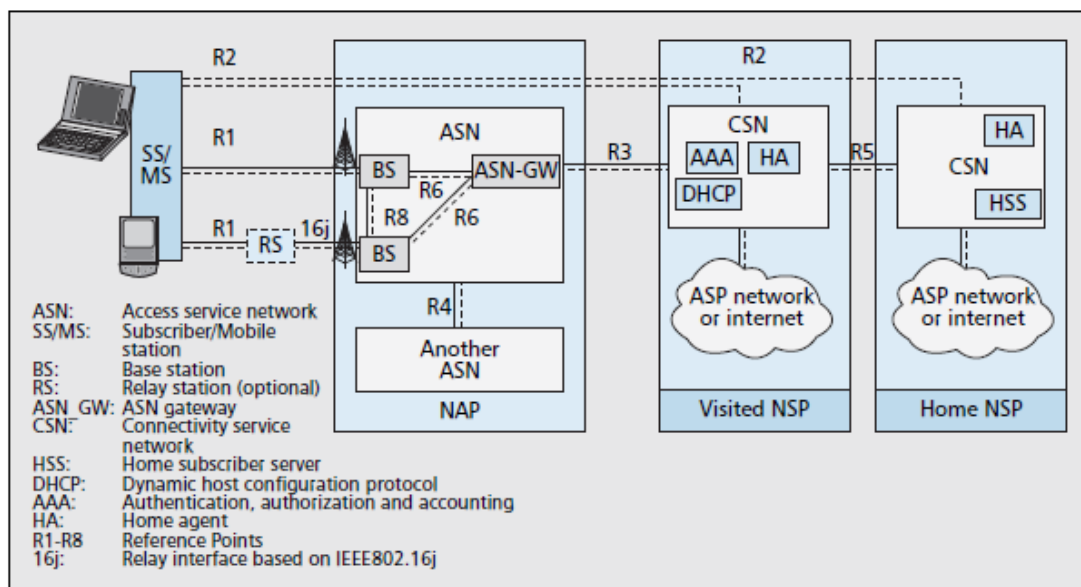

## LTE

The logical baseline architecture for 3G is complicated today and the figure of it is described below. 3GPP's goal is to simplify the 3G architecture and define an all-IP, packet-only core network which is evolved packet core (EPC). LTE has to implement EPC to meet some goals of it<sup>[18]</sup>.

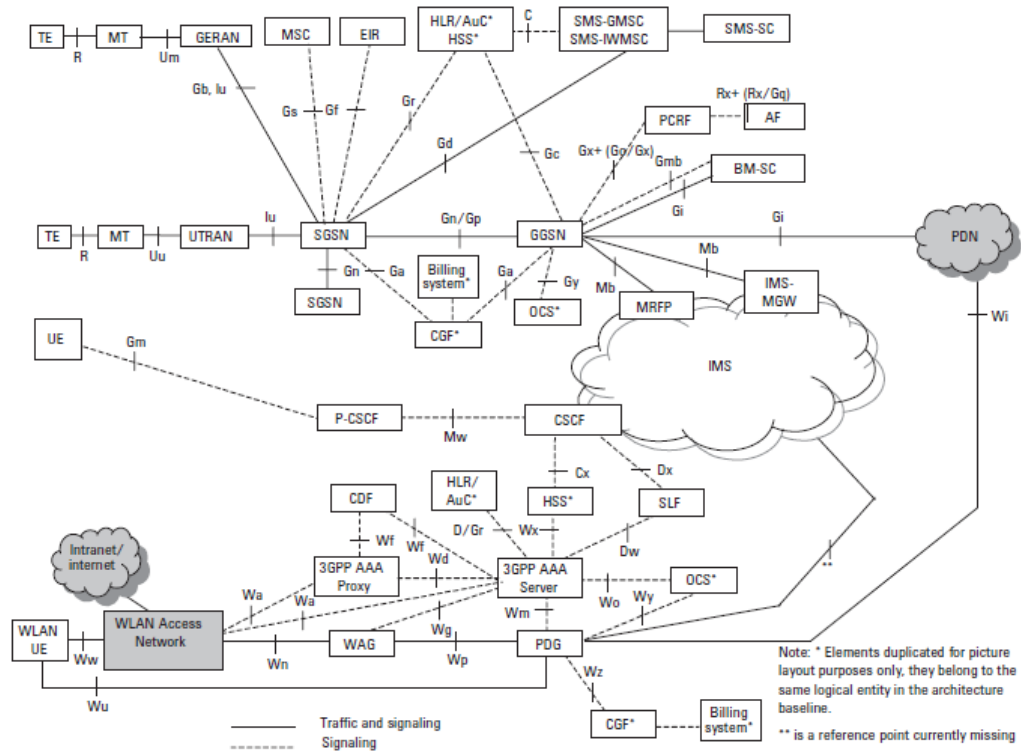

The aims of LTE architecture are to provide open interfaces to support multi-vendor deployments and robustness-no single point of failure, support multi-Radio Access Technology (RAT) with resources controlled from the network and seamless mobility as well as maintain appropriate level of security. To acquire these goals, LTE model decides not to use Radio Network Controller (RNC). The LTE has evolved the EPC interact with legacy radio access technologies as follows.

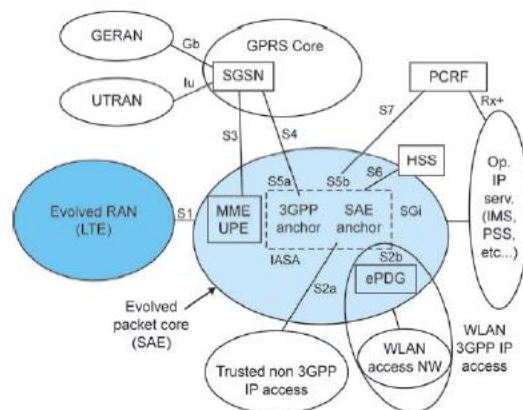

The architecture of the LTE RAN is also simplified as the EPC. The figure following presents the E-UTRA which includes a new network element, the eNB providing the E-UTRA user plane and control plane protocol terminations toward the user equipment (UE).

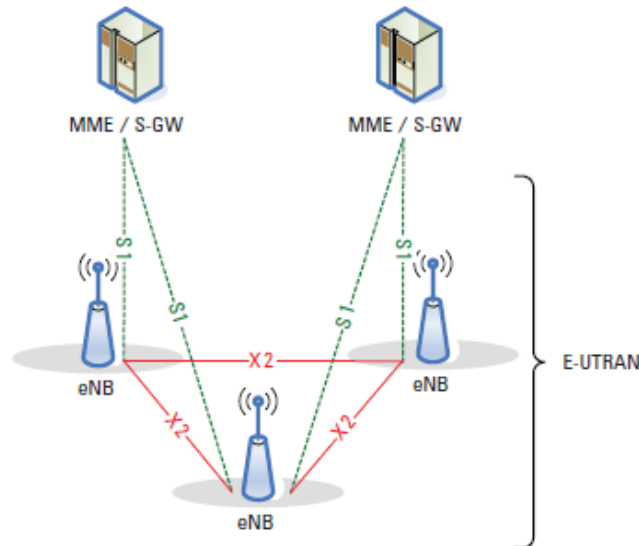

From the figure, a new interface called X2 connects the eNBs as a mesh network which communicates directly between the elements and eliminating the need to funnel data back and forth through a RNC. The E-UTRAN is connected to the EPC via the S1 interface while connecting the eNBs to the mobility management entity(MME) and serving gateway(S-GW) elements through a 'many-to-many' relationship.

This new architecture pushes more signaling down to the eNBs by splitting the user plane and mobility management entities as depicted in the figure below<sup>[19]</sup>.

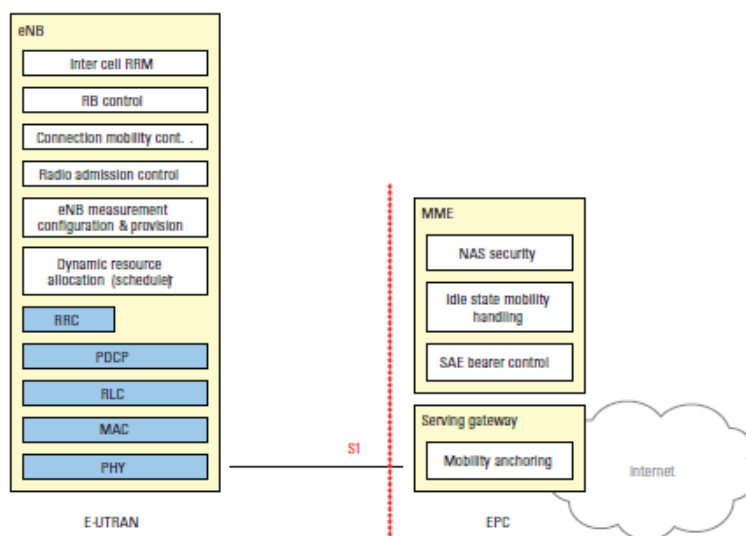

The eNB has some functions such as radio resource management, IP header compression and encryption, selection of MME at UE attachment, routing of user plane data towards S-GW,

scheduling and transmission of paging messages and broadcast information, measurement and measurement reporting configuration for mobility and scheduling, scheduling and transmission of ETWS messages.

The MME has many functions including non-access stratum(NAS) signaling and NAS signaling security, access stratum(AS) security control, idle state mobility handling and EPS bearer control

The S-GW hosts these function which are mobility anchor point for inter eNB handovers, termination of user-plane packets for paging reasons and switching of user plane for UE mobility.

The packet data network(PDN) gateway(P-GW) provides such functions as UE IP address allocation, per-user-based packet filtering and lawful interception.

### **3.2 Frame structure**

#### **WiMAX**

For WiMAX, a frame duration of 5 ms is used along with time division duplexing(TDD)<sup>[20]</sup>. To allocate for DL and the rest of UL transmissions, the frame is splitted into OFDM symbols. The first symbol in the frame is used for preamble transmission which is used by the SS for BS identification, timing synchronization and channel estimation. Subchannels are formed out of a group of subcarriers and used to send control and data transmissions. A typical allocation spans the subchannel and symbol axes and typically a 2-dimensional region is assigned for a transmission for both DL and UL transmissions. The base station(BS) announces a schedule each frame period to convey the DL and UL allocation. To avoid interference between downlink and uplink signals, they are separated by small time gaps called Transmit Time Gap(TTG) for the transition from downlink sub-frame to uplink sub-frame and Receive Time Gap(RTG) for the transition from uplink sub-frame to downlink sub-frame.

#### **LTE**

LTE uses two frame structure: frame structure type 1(FS1) for full duplex and half duplex FDD, frame structure type 2(FS2) for TDD.

For FS1, the frame duration of 10 ms is divided into subframes of 1 ms duration. Each subframe is consist of two slots of 0.5 ms duration. The FS1 is identical in the uplink and downlink in terms of frame, sub-frame, and slot duration however the allocation in terms of physical signals and channels is different. The uplink and downlink transmissions are separated in the frequency domain.

For FS2, it is made of two 5 ms half-frames for a total duration of 10 ms for a 5 ms switch-point periodicity. Su-frames consists of a uplink or a downlink transmission besides some subframes have uplink and downlink at the same time which are separated by a transmission gap(GP). Allocation procedure is decided by one of the seven different configurations. Here, subframes 0

and 5 are for downlink frame while sub-frame 1 is for a both-links frame. The composition of other sub-frames varies based on the configuration.

### 3.3 MIMO technology

#### WiMAX

In the region of open-loop transmit diversity, Space-frequency block coding(SFBC) with precoder cycling is used while single codeword with precoder cycling is supported in the region of open-loop spatial multiplexing. For closed-loop spatial multiplexing, WiMAX uses advanced beamforming and precoding. In multi-user MIMO side, closed-loop and open-loop MU-MIMO are allowed. At downlink side, WiMAX can meet the requirement of up to 8 streams with SU-MIMO while up to 4 users(non-unitary precoding) with MU-MIMO. The data will change into up to 4 streams with SU-MIMO and up to 4 users with MU-MIMO at uplink side.

#### LTE

For LTE, it uses SFBC or SFBC with frequency-switched transmit diversity(FSTD) in open-loop transmit diversity technique while multiple codewords with large delay cyclic delay diversity(CDD) is employed in open-loop spatial multiplexing. For closed-loop spatial multiplexing, LTE allows codebook-based precoding and UE-specific RS based beamforming. Meanwhile, closed-loop MU-MIMO is used in multi-user MIMO. LTE can allow up to 4 streams with SU-MIMO and up to 2 users(unitary precoding) with MU-MIMO at downlink side. For uplink side, 1 stream with SU-MIMO and up to 8 users with MU-MIMO can be supported.

### 3.4 MAC Layer

#### WiMAX

##### Control Plane

MAC layer of WiMAX is connection-oriented. Communication between SS and BS is controlled by the MAC controlling messages including network access, distance measurement, switching, idle / sleep modes processes which need the interaction between and SS and BS. The functions of control plane and data plane in MAC are implemented in MAC CPS sublayer. For control plane, the main functions are connection management, network access, bandwidth allocation, service QoS, radio bearer control, switching control, multicast and broadcast.

##### Data Plane

MAC data plane of WiMAX has different functions at sending and receiving sides. For sending side, the data are packaging into appropriate MAC PDU based on specific bandwidth allocation with reading amount of Protocol Data Unit(PDU) and combining service flow transforming strategies. In the process of packaging, many mechanism such as fragment and pack can be used

in the case of implementing by protocol strictly. For receiving side, CPS decompose MAC PDU received from physical layer into MAC SDU based on standard MAC PDU format and also combined service flow transforming strategies first. Then CPS identifies CS PDU and MAC management signaling correctly, and forward them to appropriate signaling MAC CS or appropriate signaling receiver module. WiMAX also allows ARQ function which is mostly achieved in the CPS data plane.

## LTE

### Control Plane

The function modules of LTE control plane are mostly in the RLC sublayer which are system messages broadcasting, radio paging, RLC connection management, radio bearer control, mobility management, QoS management, UE measurement reporting and controlling, MBMS service broadcasting and security management.

### Data Plane

Data plane of LTE MAC layer is called user plane which contains the functions of PDCP sublayer, RLC sublayer, MAC sublayer. The function module of PDCP sublayer mostly includes IP header compression, encryption and integrity protection. RLC sublayer provides the PDU operation, retransmission and sequential transmission. The functions of MAC sublayer are channel mapping, logical channel multiplexing, random access, HARQ retransmission, uplink and downlink scheduling. MAC sublayer offers service to RLC sublayer by logical channel which is defined by the type of its bearer information.

The graph of the function module comparison for WiMAX and LTE is below

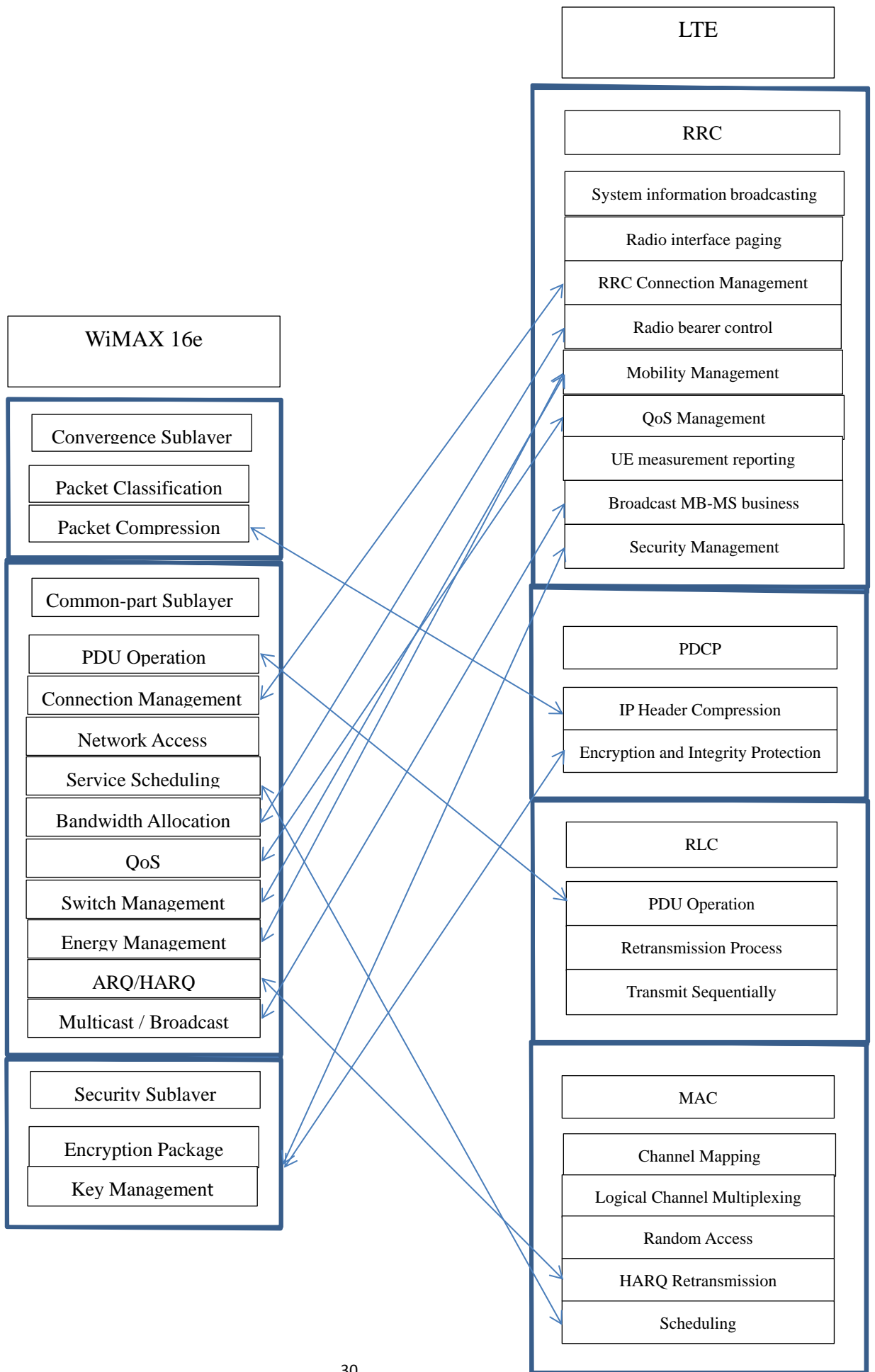

### 3.5 Multiple Access Technology

WiMAX uses OFDM and OFDMA techniques in both uplink and downlink sides. But there is a big problem which is they will lead to a high Peak-to-average ratio(PAR). To avoid this problem and also consider the power efficiency for user equipment, LTE decides to use SC-FDMA for its uplink side and OFDMA for its downlink side.

### 3.6 QoS

Both WiMAX and LTE define an end-to-end IP based QoS but requires QoS requests to traverse different protocol layers and different network portions. However, they define different attributes and QoS types.

#### WiMAX

The key SF QoS attributes defined by WiMAX are as follows.

Attributes	Full name	Functions
MSTR	Maximum sustained traffic rate	Capping rate level of an SF
MTB	Maximum traffic burst	Maximum continuous burst a system should accommodate for a service
ML	Maximum latency	Specifies maximum packet delay over the air interface
TJ	Tolerated jitter	Specifies maximum packet delay variation(jitter) for an SF
TP	Traffic priority	Priority of packets of different SFs based on a combination of subscribers' profiles and services mapped to SFs
UGI	Unsolicited grant interval	Time interval between successive data grant opportunities for an SF over DL
UPI	Unsolicited polling interval	Maximal interval between successive polling grant opportunities for an SF over UL

WiMAX define five classes of services which are presented below.

Classes	Description	Application
Unsolicited Grant Service(UGS)	For Constant Bit Rate(CBR) and delay-dependent applications	VOIP
Real-Time Polling Service(rtPS)	For Variable Rate and delay dependent	Streaming audio, Streaming video



	application	
Extended Real-Time Polling Service(ertPS)	For variable Rate and delay dependent applications	VOIP with silence suppression
Non-real-time Polling Service(nrtPS)	Variable rate and non-real time application	FTP
Best Effort(BE)	Best Effort	E-mail, web traffic

## LTE

There are some QoS attributes associated with the LTE bearer which are below<sup>[21]</sup>.

Attributes	Full name	Functions
QCI	QoS class identifier	A scalar representing a set of packet forwarding treatments
ARP	Allocation and retention priority	Call admission control and overload control for control plane treatment of a bearer
MBR	Maximum bit rate	The maximum sustained traffic rate (only valid for GBR bearers)
GBR	Guaranteed bit rate	The minimum reserved traffic rate the network guarantees
AMBR	Aggregate MBR	The total amount of bite of a group of non-GBR bearers

LTE also define some classes of service with priority and levels of Qos Class Identifier(QCI).

Example Service	Priority	QCI
IMS signalling	1	5
Conversational voice	2	1
Real time gaming	3	3
Conversational video(live streaming)	4	2
Non-conversational video(buffered streaming)	5	4
Video(Buffered Streaming) TCP-based	6,8,9	6,8,9
Voice, Video(Live Streaming), Interactive Gaming	7	7

## 4 Connection Admission Control algorithm (CAC) and Two-Level Scheduling Algorithm (TLSA)

Here Connection Admission Control algorithm and Two-Level Scheduling Algorithm proposed by Zeeshan AHMED in his PHD thesis[22] is introduced which is for the base station uplink scheduler. A connection admission control algorithm that works in conjunction with TLSA to ensure QoS for various classes of traffic is also offered. The proposed architecture consists of pre-processor, data and control queues, traffic policing module, connection admission control algorithm(CAC), base station uplink scheduler and subscriber station scheduler. The functions of these componets are presents as follows.

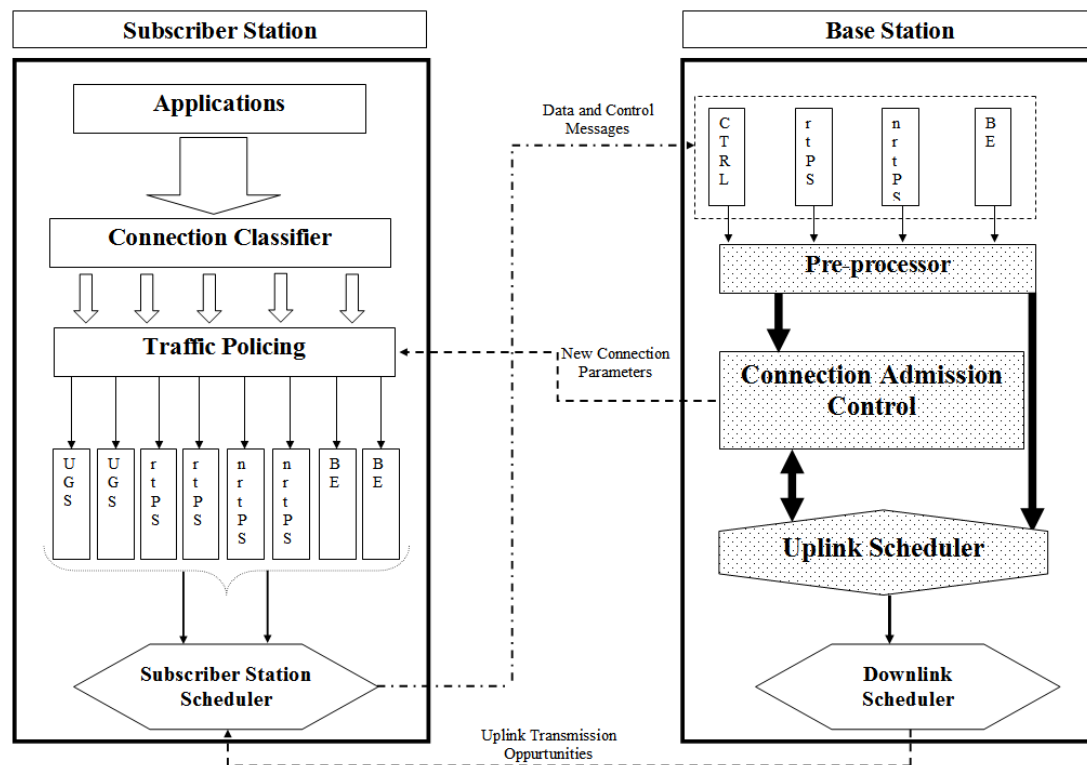

### 4.1 Pre-processor

Pre-processor is responsible for processing the control and bandwidth request messages received from the subscriber stations. The messages are extracted bandwidth requests from the established connection while used to build new connections. Afterwards, it transmits the information to the concerned modules to acquire further processing.

In this algorithm, Dynamic Service Addition(DSA) which can be used by subscriber stations to report the QoS requirements of an incoming connection to the base station. Its structure includes Subscriber station identifier(SID), Service flow identifier(SFID), Class of service requested for the service flow(Class), Requested minimum traffic rate(MRTR), Specified maximum traffic rate(MSTR), maximum tolerable delay(Latency), maximum tolerable variation in delay(Jitter), Timestamp of the request(Timestamp). The main function of DSA is to facilitate the exchange of QoS information during connection setup while the new connection request is added at the subscriber station. The information is passed from DSA to the CAC module. The other function of

DSA is that it can extract bandwidth request information from subscriber station messages and to estimate the sizes and deadlines of the packets arrived during the previous MAC frame. Afterwards, Bandwidth Request(BR) structure is created which is to estimate values of packet sizes and deadlines. The detail of BR is composed of SID, connection identifier(CID), Type where 0 equals to aggregate request and 1 equals to incremental request, Size of bandwidth requested(BRQ) and Timestamp.

For realtime connections, the deadline of the packet is the criteria for dropping them in station scheduler. Here the pre-processor module estimates the deadlines of the packets by adding the maximum tolerable latency to the arrival time.

## **4.2 Queue Management**

Queue Management is different at subscriber station and the base station. For subscriber station, a separate queue is used to store data packets of each connection. The process of the data at subscriber station is that it is passed through a packet classifier first, then stored in appropriate queues. For example, the packets of the same connection stay in a separate queue dedicated for that connection. For base station, each service class has an associated queue to hold bandwidth request until processing by the uplink scheduler such as each intra-class scheduling algorithm has only one queue to process. Pre-processor extracts a BR structure as a bandwidth request queue which is processed in FIFO order. And the order of uplink transmission opportunities are determined by scheduling algorithm.

## **4.3 Traffic policing**

Traffic policing is to monitor application traffic and to take appropriate actions to ensure that the traffic of each connection is in compliance with the traffic contract. When the application data generation rate exceeds the maximum sustained traffic rate, the module will discard traffic and signal the action to the application layer to adapt traffic shaping which can make sure that their traffic not be over limits and discarded.

## **4.4 Connection Admission Control(CAC)**

Connection Admission Control(CAC) is a set of actions and permissions in network communication that identifies where the connection is permitted on the basis of network ability. CAC performs the following two operations while establishing a connection: (1).The delay and minimum traffic rate of the new connection can be assured ; (2). Delay and throughput guarantees of the existing connections are still valid.

Bandwidth stealing is used to accommodate a new connection where the minimum service levels of existing connections should be ensured. If a new connection arrives when all the network resources are in use, then CAC module can take the resource from the established connections to admit the new connection such that at least the minimum service level could be guaranteed to both the new and all existing connections. The connection cannot be built when the minimum service level is not reached. For sure, degrading the service levels of existing connections is

undesirable as it reduces user-satisfaction. There is an order for stealing bandwidth which are followed by BE, nrtPS, rtPS. No bandwidth stealing can be done from UGS and ertPS classes. For BE class, the stealing bandwidth can be stopped until the total bandwidth gets to the size of bandwidth reserved for BE class. For nrtPS, the ending point is to reach the minimum traffic rate of the connection. For rtPS, if there is still some need of bandwidth for the new connections, then it is taken from rtPS class as long as conditions (1) and (2) are satisfied.

The stealing bandwidth request for BE connection can be always admitted by the CAC module since BE connection does not need any guarantee for throughput and delay. The minimum throughput level is the main demand for nrtPS connections. Therefore, the request for nrtPS to get bandwidth can be reached when this condition is satisfied. An rtPS connection requires guarantees on both the minimum traffic rate and maximum delay. These two aspects have to be considered before the operation for stealing bandwidth from it.

#### 4.5 Two-Level Scheduling Algorithm

TLSA has two levels which are an inter-class scheduling algorithm distributing available uplink bandwidth among various service classes for the first level and then a class-specific algorithm for distributing bandwidth in the specified class for the connection. The hierarchical representation of TLSA is as follows.

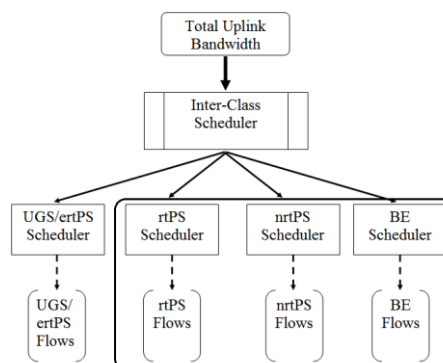

##### 4.5.1 Inter-Class Scheduling

The service class priority order suggested by IEEE 802.16 standard is valid in this inter-class scheduling which are UGS/ertPS, rtPS, nrtPS, BE. As a result, enough resources can be provided to each service class in this inter-class scheduling algorithm. The QoS level guaranteed by the CAC module is ensured for all service. Lower priority flows can not disturb the bandwidth allocation for higher priority flows. Efficient bandwidth utilization can be accomplished and no service class starves. The details of this part is presented below.

##### UGS and ertPS

IEEE 802.16 standard specifies fixed-bandwidth allocation for UGS and ertPS. Here MRTR equals to the fixed-bandwidth allocation. For example,  $\alpha_i$  is the MRTR of connection  $i$ , where  $i \in \Delta_{UGS} \cup \Delta_{ertPS}$  which are the set of all connection of UGS and ertPS admitted by the base station. In this algorithm,  $\sum_{\Delta_{UGS}} \alpha_i$  and  $\sum_{\Delta_{ertPS}} \alpha_j$  units of bandwidth are allocated to UGS and

ertPS respectively.

nrtPS

The intra-class scheduling algorithm ensure of provding at least the MRTR to each connection. The minimum bandwidth equals to the sum of the minimum traffic rates. The allocation of bandwidth which is also the minimum amount of bandwidth  $\beta_{nrtPS}$  can be min  $(\sum_{i \in \Delta nrtPS} \alpha_i, \sum_{i \in \Delta nrtPS} \rho_i |f|)$ ,  $\rho_i |f|$  is the total queue size of connection  $i$  at frame  $f$ .

BE

There is no minimum traffic rate for BE connections so that it is not necessary to make bandwidth allocations. To avoid starvation of BE class, this inter-class scheduling algorithm reserves a small part of uplink bandwidth. The bandwidth  $\beta_{BE}$  should be less than or equal to  $\sum_{i \in \Delta BE} \rho_i |f|$  and also the maximum possible value of  $\beta_{BE}$  which is also can be the service providers to best suit their business model.

rtPS

Since  $\beta_{nrtPS}$  and  $\beta_{BE}$  units of bandwidth are reserved for nrtPS and BE, repectively, the available for the rtPS class should be  $\beta - \beta_{UGS} - \beta_{ertPS} - \beta_{nrtPS} - \beta_{BE}$  which is the maximum amout of bandwidth for rtPS. However, the current bandwidth requirements of rtPS has to be considered.  $\theta_{rtPS}$  is defined as the bandwidth allocated to the rtPS class,

$$\theta_{rtPS}|f| = \min(\sum_{k \in \Delta rtPS} \rho_k |f|, \beta - \sum_{j \in \Delta UGS \cup \Delta ertPS} \alpha_j - \beta_{nrtPS} - \beta_{BE})$$

If the bandwidth units can be left after using by rtPS, they can be utilized by nrtPS and BE classes. As a result, actual size of bandwidth allocated to nrtPS class should be

$$\theta_{nrtPS}|f| = \beta_{nrtPS} + \min(\sum_{i \in \Delta nrtPS} \rho_i |f| - \beta_{nrtPS}, \beta - \sum_{j \in \Delta UGS \cup \Delta ertPS} \alpha_j - \theta_{rtPS}|f| - \beta_{BE})$$

The maximum amount of bandwidth ( $\theta_{BE}$ ) available to the BE class will be

$$\theta_{BE} = \beta - \theta_{rtPS}|f| - \theta_{nrtPS}|f| - \sum_{j \in \Delta UGS \cup \Delta ertPS} \alpha_j$$

#### 4.5.2 Intra-Class Scheduling

rtPS Scheduling

Fairness To make sure the fairness for the rtPS resource allocation, Service Ratio is introduced in this algorith. It is computed separately for each connection at the beginning of each

scheduling round by using  $\Psi_i |f| = \frac{\sum_{t=1}^{f-1} \gamma_i |t|}{\sum_{t=1}^{f-1} \Gamma_i |t|}$ , here  $\gamma_i |t|$  is bandwidth received by connection  $i$  at the start of frame  $f$  and  $\Gamma_i |t|$  is the bandwidth requested by connection  $i$  at the start of frame  $f$ . Mean

Service Ratio is also introduced which is calculated by  $\Psi' |f| = \frac{\sum_{i=1}^{f-1} \sum_{i \in \Delta rtPS} \gamma_i |t|}{\sum_{i=1}^{f-1} \sum_{i \in \Delta rtPS} \Gamma_i |t|}$ . It is the ratio of total

service availed by all rtPS connections to total service requested by these connections. If  $\Psi_i |f| > \Psi' |f|$ , it means that where are some connections receiving les service than connection  $i$  which should be given a higher priority. Both  $\Psi_i$  and  $\Psi'$  take bandwidth from leading flows and

distribute it among lagging flows. MRTR of each rtPS connection can be ensured by using these two parameters. If the value of Service Ratio of each connection equals to Mean Service Ratio, we can call this bandwidth allocation completely fair which is  $\Psi_i = \Psi_j = \Psi'$ , here  $i, j \in \Delta_{rtPS}$ .

**Scheduling** Base station provides periodic dedicated bandwidth request opportunities to connections. Deadline of is an important data for rtPS packet. So maximum tolerable latency of connections is used as a criteria to determine the polling order of rtPS connection. The subscriber station of rtPS connections which has the lowest maximum latency is polled first. So on and so forth. As a result, the base station receives and processes the bandwidth requests in increasing order of tolerable latency which can prioritize connections with tight delay constraints.

An rtPS connection  $i$  is allowed to receive bandwidth allocation if  $\Psi_i|f| \leq \Psi'|f|$ . The base station uplink scheduler always tries to allocate the bandwidth close to the total amount of  $\Gamma_i|f|$ . But sometimes the bandwidth which is can be used is not enough to cover the bandwidth request, the scheduler will utilize the available bandwidth in  $f$  to finish a part of  $\Gamma_i|f|$ . The other part of request will be dealt in frame  $f + \frac{\delta_i}{\gamma}$ , here  $\delta_i$  is the maximum tolerable latency for connection  $i$ ,  $\gamma$  is the duration of MAC frame in seconds.

Base station uplink scheduler uses bandwidth allocation table which is an  $|\Delta_{rtPS}| \times \delta'$  to realize this process.  $|\Delta_{rtPS}|$  is the total number of elements in  $\Delta_{rtPS}$  and  $\delta'$  equals to  $\max(\frac{\delta_i}{\gamma})$  where  $i \in \Delta_{rtPS}$ .

Here  $\Lambda$  represents the bandwidth allocation table. An entry  $\Lambda_{r,s}$  is an ordered pair  $(\epsilon, \phi)$  where  $\epsilon$  and  $\phi$  are bandwidth allocations to connection  $r$  in frame  $f+s$ .  $\epsilon$  is called confirmed allocation and  $\phi$  is called tentative allocation. Confirmed allocation can be guaranteed for  $r$  in frame  $f+s$  but tentative allocation can not which is just possibly allocated between frames  $f$  and  $f+s$ . UL\_MAP can be generated by the base station with the utilization of bandwidth allocation table. At the end of each scheduling round, the first column of the allocation table corresponds to UL-MAP for the next uplink subframe.

### nrtPS Scheduling

The most important data to be ensured in nrtPS scheduling is minimum traffic rate for each connection. This algorithm guarantees MRTR for each connection first, then allocates more bandwidth for the connections which has greater queue size(backlog). Let connection  $v$  belongs to  $\Delta_{nrtPS}$ ,  $\rho_v|f|$  is the current bandwidth demand. For all nrtPS, the algorithm will allocate  $\min(\rho_v|f|, \alpha_v)$  bandwidth for  $v$ . In this way, minimum traffic rate bandwidth can be made sure. Afterwards, the proportion of queue sizes of each connection will be a standard to allocate the leaving bandwidth for each other. The bandwidth requirements of connection  $u$  which is denoted by  $\eta_u$  equals to  $\rho_u|f| - \min(\rho_u|f|, \alpha_u)$ . Here  $r_{nrtPS}$  is the available bandwidth in frame  $f$ . This algorithm will deal with the residual bandwidth according to  $\theta_u = \min(\rho_u|f|, \alpha_u) + \min(r_{nrtPS}, \sum_{v \in nrtPS} \eta_v) (\frac{\eta_u}{\sum_{v \in nrtPS} \eta_v})$ . The algorithm guarantees the minimum traffic rate and takes backlog of each connection as weight to allocate bandwidth for more demanding connections.

## BE Scheduling

A subscriber station with bad channel conditions use more time-slots but transfer less data comparing to the subscriber station with good channel conditions. In this algorithm, to make a better use of radio resource usage, it will distribute the available time-slots equally among BE connections. For instance,  $C$  is the numer of available time-slots for BE traffic and  $|\Delta_{BE}|$  is the number of BE connectinons. So the available slots for eahc connection will be  $C / |\Delta_{BE}|$ . For a BE connections  $w$ ,  $\rho_w|f|$  is the current bandwidth request and  $C_w$  is required time-slots. This algorithm allocates  $\min(C_w, C / |\Delta_{BE}|)$  to  $w$ . The slots will be allocated to the connection in turns to avoid the number of available time-slots is less than BE connections number. More data will be transmitted by the subscriber station with good channel condition within the same number of time-slots. In this way, the scheme can prevent subscriber stations with poor channel conditions to affect the entire network, with avoiding starvation of such subscriber stations.

## 5 Simulation of Two-level scheduling algorithm in QualNet

In this chapter, we provide a simulation of Two-level scheduling algorithm to check if it can have a good performance when the physical channel condition changes. Simulation is an attempt to model a real-life or hypothetical situation to evaluate the performance of a system, existing or proposed, under different configurations of interest and over long periods of realtime. A design validation tool can avoid unforeseen problems and offer desired performance levels. Meanwhile, simulation has become a useful part of modeling many natural systems in various region to gain insight into the peration of those systems.

A model is a representation of a system or process. A simulation model is a representation that incorporates time and the changes taht occur over time while it is a descriptive model of a process or system, and usually includes parameters that allow the model to be configurable, that is, to represent a number of somewhat different system or process configurations. Simple examples include parameters that allow a user to vary the number of workers at a workstation, the speed of a machine or vehicle, the timing characteristics of a conveyor control system, and so on. As a descriptive model, you can use a simulation model to experiment with, and evaluate and compare, any number of system alternatives. Evaluation, comparison and analysis are the key reasons for doing simulation. Prediction of system performance and identification of system problems and their causes are the key results.

Simulation analysis can be concluded into such parts as model development, experiment design, simulation running, data collection and analysis, conclusion formulation and decision making complete simulation needs numbers of experiments in which some parameters change at the input side and different values are achieved at the output side. Researchers should test their algorithms in different condition to check if it has good performance and robustness. Understanding of behaviors and characteristics of systems becomes very important in this situation.

Model development is very critical of the whole simulation analysis. We can configure the real system by studying the operation of the model. Model development consists of two major

activities which are development of data structures to represent the data needed by the model and translation of the modeling assumptions in the Assumptions Document into the language or representation required by the simulation package. The simulation analyst must design data structures that represent the data and its inter-relationships as well as fit into those allowed by the simulation software. A good model is simpler than the the real system which can enable the reserchers to acquire an accurate results with expected behavior of the system<sup>[23]</sup>. Meanwhile, a good model is an appropriate compromise between realism and simplicity. A model must be validated extensively before its application where model validation is a strenuous process and involves observing model output under a broad range of input. As reserched for the simulation tool in the present markets, commercial network simulators provide a good opportunity for efficient experimentation while offering many benifits such as validated implementation of existing protocols, a rich infrastructure for developing new protocols, the opportunity to study large-scale protocol interaction, easier comparison due to standardized set of result. Since Qualnet can provide a faithful model for the 802.16 standard while equipping a user-friendly graphical user-interface and analytical tools, we decided to use Qualnet to do the simulation ananlysis.

## 5.1 QualNet Introduction

QualNet provides a comprehensive environment for designing protocols, creating and animating network scenarios, and analyzing thrie performance. QualNet is composed of the following tools: QualNet Architect—A graphical experiment design and visualization tool. Architect has two modes: Design mode, for designing experiments, and Visualize mode, for running and visualizing experiments<sup>[24]</sup>; QualNet Analyzer—A graphical statistics analyzing tool; QualNet Packet Tracer—A graphical tool to display and analyze packet traces; QualNet File Editor—A text editing tool; QualNet Command Line Interface—Command line access to the simulator; QualNet is a comprehensive suite of tools for modeling large wired and wireless networks. It uses simulation and emulation to predict the behavior and performance of networks to improve their design, operation and management; QualNet enables users to design nex protocol models, optimize new and existing models, design large wired and wireless networks using pre-configured or user-designed models, analyze the performance of networks and perform what-if analysis to optimize them.

The key features of QualNet that enable creating a virtual network enviroment are :

**Speed:** QualNet can support real-time speed to enable software-in-the-loop, network emulation, and hardware-in-the-loop modeling. Faster speed enables model developers and network designers to run multiple “what-if” analyses by varying model, network, and traffic parameters in a short time.

**Scalability:** QualNet can model thousands of nodes by taking advantage of the latest hardware and parallel computing techniques. QualNet can run on cluster, multi-core, and multi-processor systems to model large networks with high fidelity.

**Model Fidelity:** QualNet uses highly detailed standards-based implementation of protocol models. It also includes advanced models for the wireless environment to enable more accurate modeling of real-world networks.

**Portability:** QualNet and its library of models run on a vast array of platforms, including Windows



XP, Mac OS X, and Linux operating systems, distributed and cluster parallel architectures, and both 32- and 64-bit computing platforms. Users can now develop a protocol model or design a network in QualNet on their desktop or laptop Windows XP computer and then transfer it to a powerful multi-processor Linux server to run capacity, performance, and scalability analyses. Extensibility: QualNet can connect to other hardware and software applications, such as OTB, real networks, and third party visualization software, to greatly enhancing the value of the network model.

### 5.1.1 QualNet Architecture

QualNet architecture is illustrated below. A high-level description of the various components is provided shortly.

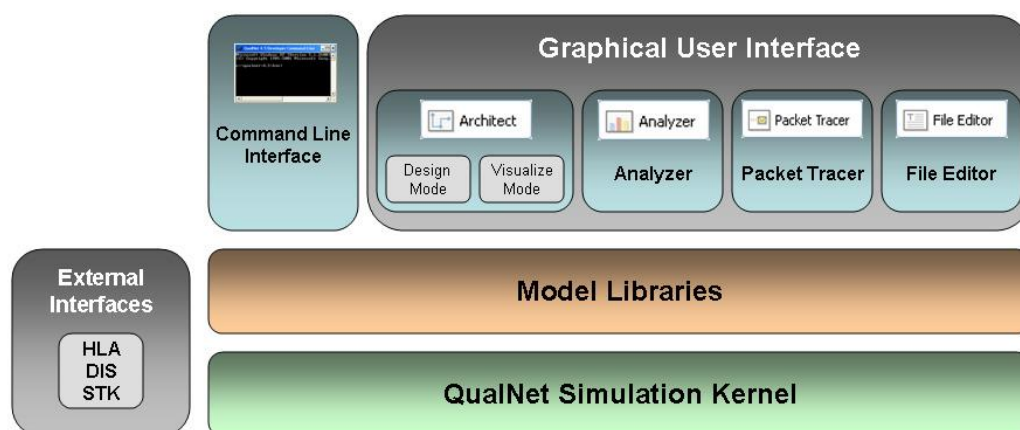

**QualNet Kernel :** The kernel of QualNet is a Scalable Network Technologies-proprietary, parallel discrete-event scheduler. It provides the scalability and portability to run hundreds and thousands of nodes with high-fidelity models on a variety of platforms, from laptops and desktops to high performance computing systems. Users do not directly interact with the kernel, but use the QualNet API to develop their protocol models.

**QualNet Model Libraries :** QualNet includes support for a number of model libraries that enable you to design networks using protocol models developed by Scalable Network Technologies. Purchase of QualNet includes the Developer, Wireless, and Multimedia and Enterprise Model Libraries; additional libraries for modeling WiMAX, network security, sensor networks, satellite, and cellular models are also available. Refer to the QualNet Model Libraries data sheet for more information or check the products page on our website.

**QualNet Graphical User Interface (GUI):** QualNet GUI consists of Architect, Analyser, Packet Tracer, and File Editor.

**QualNet Command Line Interface:** The QualNet command line interface enables a user to run QualNet from a DOS prompt (in Windows) or from a command window (in Linux or Mac OS X). When QualNet is run from the command line, input to QualNet is in the form of text files which

can be created and modified using any text editor. Building and running scenarios with the command line interface takes less memory and scenarios typically run faster than with the GUI. With the command line interface the users have the flexibility to interface with visualization and analysis tools of their choice.

**QualNet External Interface:** QualNet can also interact with a number of external tools in real-time. The HLA/DIS module, which is a part of the Standard Interfaces Model Library, allows QualNet to interact with other HLA/DIS compliant simulators and computer-generated force (CGF) tools like OTB. The QualNet STK interface, which is a part of the Developer Model Library, provides a way to interface QualNet with the Satellite Toolkit (STK) developed by Analytical Graphics, Inc. (AGI) and function in a client-server environment.

### 5.1.2 Scenario-based Network Simulation

In QualNet, a specific network topology is referred to as a scenario. A scenario allows the user to specify all the network components and conditions under which the network will operate. This includes: terrain details, channel propagation effects including path loss, fading, and shadowing, wired and wireless subnets, network devices such as switches, hubs and routers, the entire protocol stack of a variety of standard or user-configured network components, and applications running on the network. Most of these are optional; you can start with a basic network scenario and specify as much detail as necessary to improve the accuracy of your network model.

### 5.1.3 General Approach

In general, a simulation study comprises the following phases:

The first phase is to create and prepare the simulation scenario based on the system description and metrics of interest.

The next step is to execute, visualize, and analyse the created scenario and collect simulation results. Simulation results can include scenario animations, runtime statistics, final statistics, and output traces.

The last phase is to analyse the simulation results. Typically, users may need to adjust the scenarios based on the collected simulation results. This general procedure is downstairs.

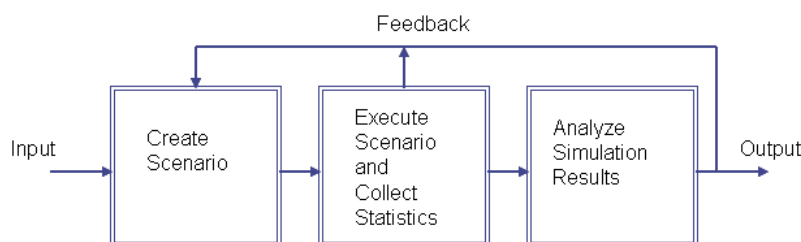

### 5.1.4 Files Associated with a Scenario

Input to the QualNet simulator consists of several files. For the command line interface, the input files are text files. The main input files for command line are:

**Scenario configuration file:** This is the primary input file for QualNet and specifies the network

scenario and parameters for the simulation. This file usually has the extension “.config”.

Node placement file: This file is referenced by the scenario configuration file and specifies the initial position of nodes in the scenario. (The node placement file may also contain the future positions of nodes.) This file usually has the extension “.nodes”.

Application configuration file: This file is referenced by the scenario configuration file and specifies the applications running on the nodes in the scenario.

In addition to the above three files, QualNet may use other input files. These additional files depend upon the models specified in the configuration file and are referenced by the configuration file. These input files are text files which can be created using any text editor. When using the command line interface, the user has to create these files manually.

When the user creates a scenario in Architect, the major input files representing the scenario (scenario configuration, node placement, and application configuration files) are automatically created by Architect. The primary output file generated by a QualNet simulation run is a statistics file, which has the extension “.stat”. This file contains the statistics collected during the simulation run. Other output files that may be generated by QualNet include the trace file (which has the extension “.trace”) which records packet traces, and the animation file which records the animation trace of a scenario when the scenario is run in Architect.

Both the statistics and trace files are text files which can be viewed using any text editor. In addition, analyser can be used to view the contents of the statistics file in a graphical, easy to analyse manner.

## **5.2 Implementation of TLSA in Qualnet**

The algorithms proposed for uplink scheduling can be classified into two categories: channel-aware and channel-unaware. The channel-aware algorithms make scheduling decisions according to channel-state information. Preference is given to subscriber stations with good channel conditions. While, the channel-unaware algorithms make scheduling decisions according to QoS requirements and bandwidth requests of individual connections. Both schemes have associated advantages and drawbacks. Channel-aware schedulers maximize overall system performance but they do not guarantee QoS for various classes of traffic. Channel-unaware algorithms can furnish QoS to various service classes, however they ignore the variable nature of wireless link. TLSA does not use the information of channel-state which means it belongs to channel-unaware algorithm. Here we are going to observe that when the channel condition becomes worse, the changeable for the performance of data transmission using TLSA will be.

First, we have to choose the parameters which can have an effect on channel-state condition such as weather condition, noise and so on. Finally, we decided to use noise, fast fading effect and slow fading effect to do the simulations.

### **5.2.1 Noise factor**

In physics and analog electronics, noise is a mostly unwanted random addition to a signal; it is called noise as a generalisation of the acoustic noise ("static") heard when listening to a weak

radio transmission with significant electrical noise. Signal noise is heard as acoustic noise if the signal is converted into sound; it manifests as "snow" on a television or video image. High noise levels can block, distort, change or interfere with the meaning of a message in human and electronic communication.

In signal processing or computing noise can be considered random unwanted data without meaning; that is, data that is not being used to transmit a signal, but is simply produced as an unwanted by-product of other activities. "Signal-to-noise ratio" is sometimes used to refer to the ratio of useful to irrelevant information in an exchange.

Noise figure (NF) and noise factor (F) are measures of degradation of the signal-to-noise ratio (SNR), caused by components in a radio frequency (RF) signal chain. It is a number by which the performance of a radio receiver can be specified. The noise factor is defined as the ratio of the output noise power of a device to the portion thereof attributable to thermal noise in the input termination at standard noise temperature  $T_0$  (usually 290 K). The noise factor is thus the ratio of actual output noise to that which would remain if the device itself did not introduce noise, or the ratio of input SNR to output SNR. The noise figure is simply the noise factor expressed in decibels (dB). In QuelNet, we can change the value of Noise figure to make a difference on the physical channel. The Human-made noise in the city and countryside is from 0-100dB.

### **5.2.2 Fading factor**

In wireless communications, fading is deviation of the attenuation affecting a signal over certain propagation media. The fading may vary with time, geographical position or radio frequency, and is often modeled as a random process. A fading channel is a communication channel comprising fading. In wireless systems, fading may either be due to multipath propagation, referred to as multipath induced fading, or due to shadowing from obstacles affecting the wave propagation, sometimes referred to as shadow fading.

The presence of reflectors in the environment surrounding a transmitter and receiver create multiple paths that a transmitted signal can traverse. As a result, the receiver sees the superposition of multiple copies of the transmitted signal, each traversing a different path. Each signal copy will experience differences in attenuation, delay and phase shift while travelling from the source to the receiver. This can result in either constructive or destructive interference, amplifying or attenuating the signal power seen at the receiver. Strong destructive interference is frequently referred to as a deep fade and may result in temporary failure of communication due to a severe drop in the channel signal-to-noise ratio.

A common example of multipath fading is the experience of stopping at a traffic light and hearing an FM broadcast degenerate into static, while the signal is re-acquired if the vehicle moves only a fraction of a meter. The loss of the broadcast is caused by the vehicle stopping at a point where the signal experienced severe destructive interference. Cellular phones can also exhibit similar momentary fades.

Fading channel models are often used to model the effects of electromagnetic transmission of information over the air in cellular networks and broadcast communication. Fading channel models are also used in underwater acoustic communications to model the distortion caused by the water. Mathematically, fading is usually modeled as a time-varying random change in the amplitude and phase of the transmitted signal.

The terms slow and fast fading refer to the rate at which the magnitude and phase change imposed by the channel on the signal changes. The coherence time is a measure of the minimum time required for the magnitude change of the channel to become uncorrelated from its previous value. Slow fading arises when the coherence time of the channel is large relative to the delay constraint of the channel. In this regime, the amplitude and phase change imposed by the channel can be considered roughly constant over the period of use. Slow fading can be caused by events such as shadowing, where a large obstruction such as a hill or large building obscures the main signal path between the transmitter and the receiver. The received power change caused by shadowing is often modeled using a log-normal distribution with a standard deviation according to the log-distance path loss model.

Fast fading occurs when the coherence time of the channel is small relative to the delay constraint of the channel. In this regime, the amplitude and phase change imposed by the channel varies considerably over the period of use. For fast fading, we decided to use Rayleigh fading model in the QuelNet.

Rayleigh fading is a statistical model for the effect of a propagation environment on a radio signal, such as that used by wireless devices. Rayleigh fading models assume that the magnitude of a signal that has passed through such a transmission medium (also called a communications channel) will vary randomly, or fade, according to a Rayleigh distribution — the radial component of the sum of two uncorrelated Gaussian random variables.

Rayleigh fading is viewed as a reasonable model for tropospheric and ionospheric signal propagation as well as the effect of heavily built-up urban environments on radio signals. Rayleigh fading is most applicable when there is no dominant propagation along a line of sight between the transmitter and receiver. If there is a dominant line of sight, Rician fading may be more applicable. Rayleigh fading is a reasonable model when there are many objects in the environment that scatter the radio signal before it arrives at the receiver. The central limit theorem holds that, if there is sufficiently much scatter, the channel impulse response will be well-modelled as a Gaussian process irrespective of the distribution of the individual components. If there is no dominant component to the scatter, then such a process will have zero mean and phase evenly distributed between 0 and  $2\pi$  radians. The envelope of the channel response will therefore be Rayleigh distributed.

Rayleigh fading is also called multipath fading in the mobile radio environment. Speed of reflecting objects can induce their own Doppler shift in the reflected wave. Doppler frequency or Doppler shift is given by  $f_d = (1/\lambda_c)V_m \cos \theta$ , where  $\lambda_c$  is the wavelength of the carrier signal,  $V_m$  is the relative velocity of the mobile, the angle  $\theta$  is between the motion of the mobile and direction

of arrival of the scattered waves, and  $V_m \cos \theta_m$  represents the velocity component of the motion of the mobile in the direction of the incoming signal. Here we can change the maximum velocity in the QualNet and choose the range from 10-60 meter/second.

### 5.2.3 Shadowing factor

For slow fading, shadowing model is chosen in QualNet. The telecommunication conditions may vary as one turns a corner, moves behind a large building, or enters a building. This can be called shadowing or large-scale fading while it belongs to slow fading.

Large-scale variations caused by shadowing of obstacles are shown to follow a log-normal distribution, which means that when measured in dB they follow a Gaussian distribution. Consequently shadowing effects they are usually incorporated into path loss estimates by the addition of a zero-mean Gaussian random variable, with standard deviation  $\sigma$ :  $N(0, \sigma)$ , where  $\sigma$  is often estimated by empirical measurements. Commonly accepted values for  $\sigma$  are between 6 dB and 12 dB.

Measured values of  $\sigma$  itself seem to display Gaussian distribution as well, in their variations from one area to another, and depend on the radio frequency, the type of environment (rural, suburban, or urban), base station and subscriber station height. Many measurement campaigns have been conducted and reported in the literature, as summarized in table bellows:

Source	Frequency(GHz)	Path Loss Exponent n	O(dB)	Comments
Seidel <sup>[25]</sup>	0.9	2.8	9.6	Suburban(Stuttgart)
Erceg <sup>[26]</sup>	1.9	4.0	9.6	Terrain-category B
Feuerstein <sup>[27]</sup>	1.9	2.6	7.7	Med.antenna height
Durgin <sup>[28]</sup>	5.8	2.93	7.85	[28]Fig.7,residential
Porter <sup>[29]</sup>	3.7	3.2	9.5	Some denser urban
Rautiainen <sup>[30]</sup>	5.3	4.0	6.1	[30]Fig.3,4

Here we use the shadowing model in QualNet and the range of shadowing mean is from 6dB to 12dB.

### 5.3 Analyse of the simulation

TLSA is implemented at base station. The function *MacDot16ScheduleUISubframe* obeys the strict priority which is UGS>ertPS>rtPS>nrtPS>BE and WFQ based scheduling. Here TLSA is modified in this function to replace strict priority and WFQ algorithms in files “mac\_dot16\_sch.h” and “mac\_dot16\_sch.cpp”. Also code is added in “mac\_dot16\_ss.cpp” to drop the expired packets from data queues.

Four performance metrics are used to analyse the performance of the proposed scheduling scheme. Throughput: The total units of data transmitted in duration  $\Delta t$  divided by  $\Delta t$ .

End-to-end Delay: The average delay observed by packets from source to destination. It includes queuing delay and propagation delay.

Packet Loss Ratio: The number of packets lost to the total number of packets sent by the sender.

Jitter: The undesired deviation from true periodicity of an assumed periodic signal.

The simulation experiments are made of three subscriber stations and one base station. All the SSs are sending CBR data to this base station at the same time. All the data types are set to rtPS. The total uplink channel capacity is set to 1Mbps. Two-ray ground reflection is used as radio propagation model. Frame duration is 20ms while TDD downlink duration is 10ms. The antenna model is omni antenna. And I set the temperature as 290K. Link adaptation and packing are enable. Each subscriber station sends 10000 items totally and the item size is 512 bytes. The CBR interval is 0.1 seconds and the simulation experiment starts at 1 seconds and ends at 1000 seconds. The total simulation time is 1000 seconds. The fading model is unused when the experiments are for noise factor and shadowing factor changing. Shadowing mean is set to 4dB in the simulation for acquiring performance for noise factor and fading factor. And the noise is set to 10dB in fading and shadowing experiments. As presented before, the fading factor ranges from 10dB and 60dB every 5dB. The noise factor increase from 10dB to 100dB with the interval of 10dB. For the shadowing factor experiment, the range is 6dB to 12dB. The experiment with each parameter is simulated 30 times. After calculating the data, we have got 12 graphs.

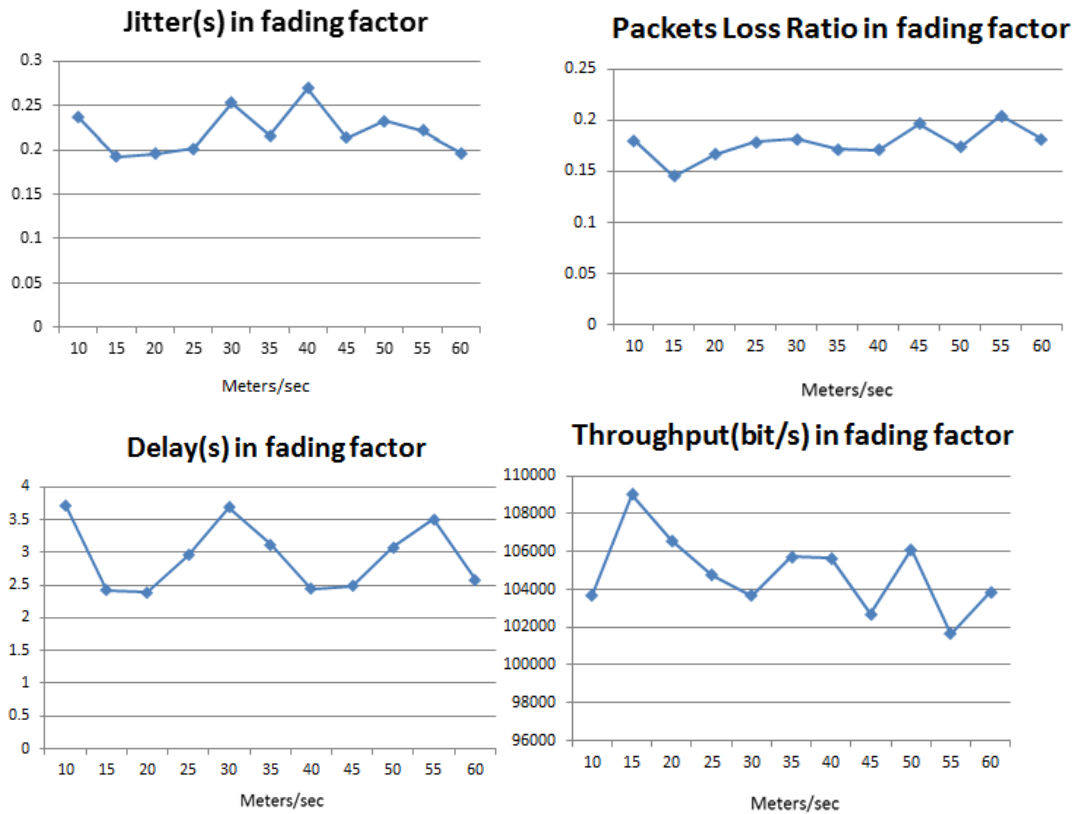

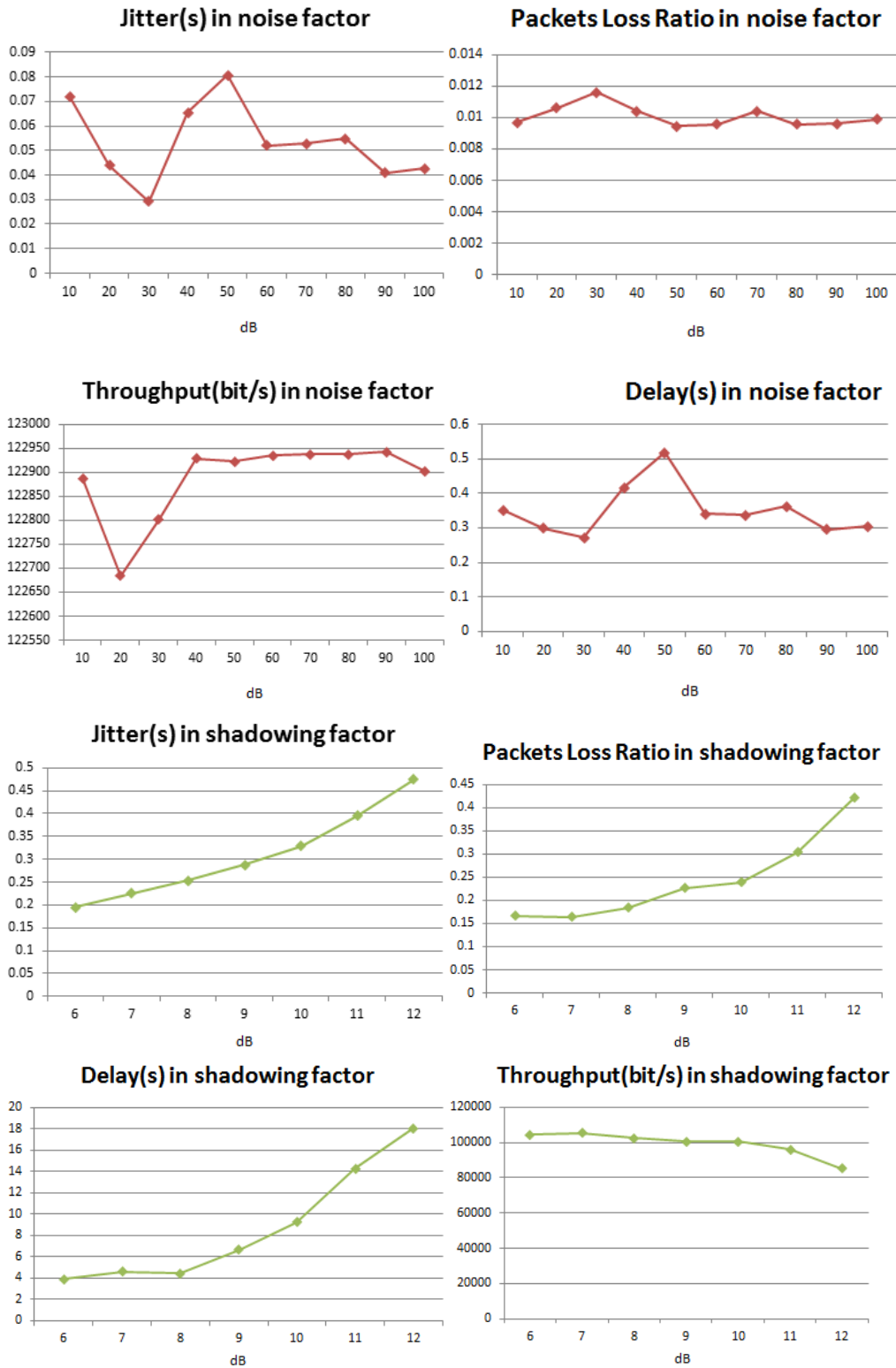

However, these results are very difficult to observe the performance. I surmise there are some mistakes in the initial set which leads to it. Finally there are three main problems affecting the statistics:

1. The start time should be delayed a little for proper routing. Otherwise there would be some packets loss in the start and therefore results would not be very accurate.



2. Simulation end time should be greater than the end time of data generation. In this case, the packets in the queue could be scheduled.

3. Data generation rates should be close to total uplink capacity, If the data generation rate is equal to available capacity, then this is full load scenario which can be also considered as a worst-case scenario. For simulation experiment, network must be tested under worst-case scenario to ensure their satisfactory operation under full system load. The data generation rate can be calculated as  $\text{packet size} \times 8 \times (1/\text{packets generation interval})$ . Here we can modify either packet size or packet generation interval to change data generation rate. Here the value of it is  $512 \times 8 \times (1/0.1) = 40960\text{bps}$  which is very far from total uplink capacity which makes the result not accurate.

As a correction, I set the start time into 10 seconds and end time into 110s while the interval is 0.01s. The total simulation time is 200 seconds. The item size is increased to 1024 bytes. Then I did the simulation experiments again and update all the data. The new graphs with new statistics are presented below.

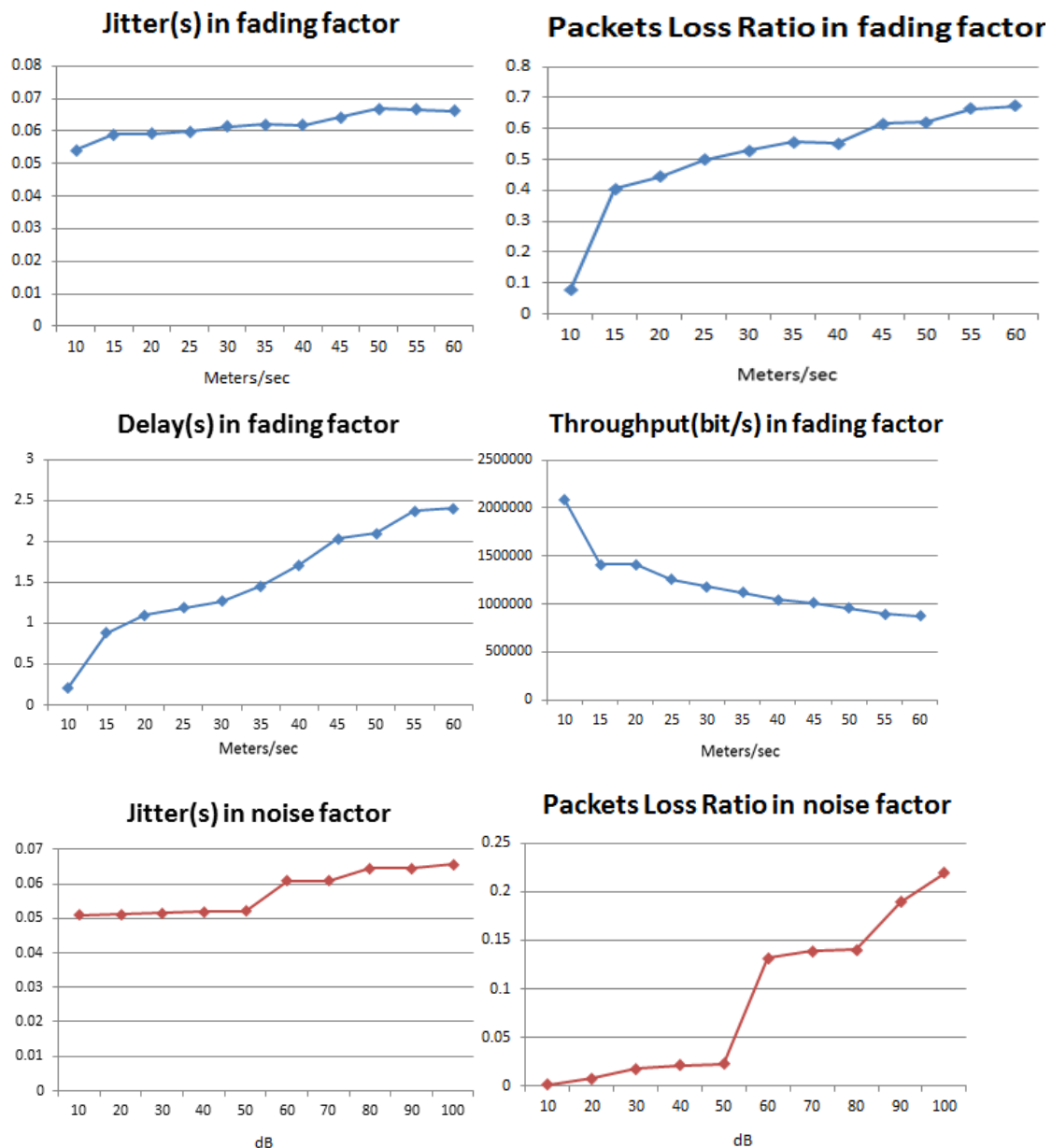

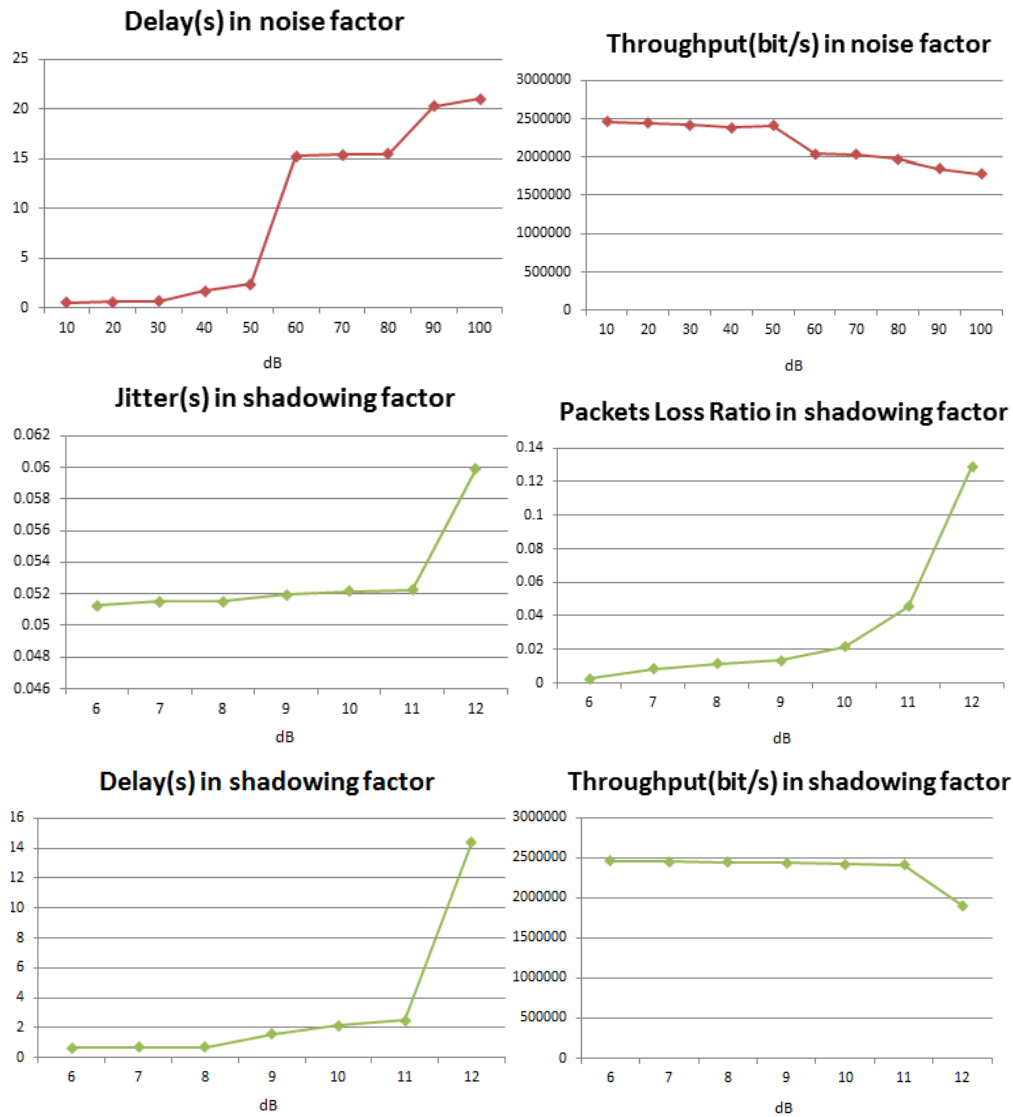

For fading factor, there is a comparative rapid increase after 10 meter/second in delay and jitter metrics. This sudden rise could make system performances bad. And it becomes worse but smoother as the velocity becomes larger in jitter. For throughput, it decreases badly just after 10 meter/second. The performance of packets loss ratio also worsens after the point of 10 meter/second.

For noise factor, no significant effect on jitter when noise is increased initially (10-50). Then a sudden rise in jitter (50-70) comes into being and then another stable region (75+) becomes. So the region of interest is between (50-70) in which jitter increases sharply (Note: low values of jitter are preferable). With increase in noise, there is a decrease of 20% in throughput. The rate of decrease is largest between noise factor (50-60). However, the overall rate of decrease seems constantly decreasing. For packet loss ratio, the pattern is same as that of delay. Packet loss ratio increases to about 0.23 and this reflects in the reduction of throughput.

For shadowing factor, it has a rapid rise after 11 dB on jitter. No change in delay is observed till the shadowing mean of 8dB. After that point a gentle increase comes out in delay till 11 units and

then a sudden jump appears in delay. This sudden rise in delay could degrade system performances. Sudden drop in throughput is observed after shadowing mean of 11 units. Throughput is quite good between 6 and 11 units with little packet drop. The packet loss ratio reaches a maximum of 0.13.

## **6. Conclusion**

The TLSA algorithm has a relative bad performance when the fast fading effect increases. But in the normal range of shadowing effecting in humans' life, it can deliver a good communication for the users as well as noise factor increases. Since it does not use the channel condition information, its performance is more than fair.

Also we have compared the technology in WiMAX and LTE who are main the competitors in the 4G communication market. They also utilize some common technique such as OFDM and MIMO. There is hot discussion about merge or competition about them nowadays. Just because of the similarities between them, more researchers are supporting the merging opinion. However, the technique used by them is not only the factor to be considered but also the market decision which is more important sometime. Merging WiMAX and LTE seems too difficult to realize. The competition between these two technologies cannot be avoided. LTE has a big advantage that more telecommunication operators decide to use it as their 4G technology finally. But it cannot mean that the WiMAX is the loser in this 4G match. Obviously, LTE is the successor of the cellular technology such as UMTS/WCDMA/HSPA/ and CDMA2000 3G while WiMAX is mainly used in broadband wireless connection and backhaul. As the expend of WiMAX is much smaller than LTE, many developing countries can choose WiMAX instead of LTE which is easier to be accomplished.

WiMAX and LTE have many differences on their way of technology developing, but they all fit in the need of wireless communication for users. Apparently, they have some specific advantages and disadvantages. However, it is more important to create a large "net" where multiple technique can be used to get a goal that users could have a better experience.

## Reference

- [1] Frank Ohrtman, “WiMAX Handbook”, McGraw-Hill Communications Companies, 2005
- [2] Jeffrey G. Andrews, Arunabha Ghosh, Rias Muhamed, “Fundamentals of WiMAX”, Pearson Education, February 2007
- [3] Y. Ahmet Sekercioglu, Milosh Ivanovich, Alper Yegin, “A survey of MAC based QoS implementations for WiMAX networks”, Computer Network(2009)
- [4] R. Farhadi, V. T. Vakili, and S. S. Moghadam, “A comparative study of scheduling algorithms for OFDMA-based WiMAX networks,” 2011 IEEE 3rd International Conference on Communication Software and Networks, no. Cid, pp. 355–359, 2011.
- [5] R. Jain, and a K. Tamimi, “Scheduling in IEEE 802.16e mobile WiMAX networks: key issues and a survey,” IEEE Journal on Selected Areas in Communications, vol. 27, no. 2, pp. 156–171, 2009.
- [6] Chou, “Two-Tier Scheduling Algorithm for Uplink Transmissions in IEEE 802.16 Broadband Wireless Access Systems,” 2006 International Conference on Wireless Communications Networking and Mobile Computing, pp. 6–9, 2006.
- [7] Kim, Seungwoon and Yeom, Ikjun, “TCP-aware Uplink scheduling for IEEE 802.16”. IEEE Communication Letter, Feb., 2007.
- [8] Zeynep Yurdakul, Sema Oktug, “A Hierarchical Channel-Aware Uplink Scheduler For WiMAX Based Stations”, 2010 Sixth Advanced International Conference on Telecommunications, IEEE computer societ y, pp. 398-403.
- [9] E. Limouchi, S. T. Branch, A. Salajeghe, M. Pourmina, and A. Zehni, “An Intra-Class Channel-Aware Scheduling in IEEE,” Network, IEEE, vol. 1, no. 8, pp. 323–325, 2011.
- [10] D. Astely, E. Dahlman, a Furuskar, Y. Jading, M. Lindstrom, and S. Parkvall, “LTE: the evolution of mobile broadband,” IEEE Communications Magazine, vol. 47, no. 4, pp. 44–51, 2009.
- [11] P. Development and T. Challenges, “Agilent 3GPP Long Term Evolution : System Overview, Product Development and Test Challenges,” 2009.
- [12] M. Alasti and B. Neekzad, “Quality of Service in WiMAX and LTE Networks,” Communications Magazine, IEEE, vol. 48, no. May, pp. 104–111, 2010.
- [13] F. D. Calabrese, C. Rosa, M. Anas, P. H. Michaelsen, K. I. Pedersen, P. E. Mogens “Adaptive Transmission Bandwidth Based Packet Scheduling for LTE Uplink”, Nokia Siemens Networks, Denmark
- [14] T.E. Kolding, “QoS-Aware Proportional Fair Packet Scheduling with Required Activity Detection”, IEEE 64th Vehicular Technology Conference, September 2006.
- [15] Sunggu Choi, Kyungkoo Jun, Yeonseung Shin, Seokhoon Kang, Byoungjo Choi. “MAC Scheduling Scheme for VoIP Traffic Service in 3G LTE” Vehicular Technology Conference, 2007. VTC-2007 Fall. 2007 IEEE 66th, 1441—1445
- [16] M. Anas, C. Rosa, F. D. Calabrese, K. I. Pedersen, and P. E. Mogensen, “Combined Admission Control and Scheduling for QoS Differentiation in LTE Uplink,” 2008 IEEE 68th Vehicular Technology Conference, vol. 68, no. September, pp. 1–5, 2008.”
- [17] K. Etemad and I. Corporation, “Overview of Mobile WiMAX Technology and Evolution,” Communications magazine, IEEE, vol. 46, no. October, pp. 31–40, 2008.
- [18] 3GPP, “3GPP System Architecture Evolution: Report on Technical Options and

- Conclusions(Release 8)”, TR 23.882.V8.0.0(2008-09)
- [19]3GPP TS 36.300 V8.4.0(2008-03)
- [20]Fan Wang et al., “Mobile WiMAX Systems: Performance and Evolution”, IEEE Communications Magazine, Volume 46, No.10, October 2008
- [21]L. Li and S. Shen, “End-to-End QoS Performance Management Across LTE Networks,” Network Operations and Management Symposium (APNOMS), 2011 13th Asia-Pacific, vol. 2011, pp. 1–4, 2011.
- [22] Zeeshan Ahmed, “Quality of Service in WiMAX for Multimedia Services”, Phd thesis, June 2013
- [23]Lee Breslau, Deborah Estrin, Kevin Fall, Sally Floyd, John Heidemann, Ahmed Helmy, Polly Huang, Steven McCanne, Kannan Varadhan, Ya Xu, et al. “Advances in network simulation. Computer”, 33(5):59–67, 2000. 124,125
- [24]Qualnet Simulator. 5.0, qualnet 5 users guide scalable network technologies.Inc 2010, 2010. 126, 128, 224
- [25]V.S. Abhayawardhana, I.J. Wassell, D. Crosby, M.P. Sellars, and M.G. Brown, “Comparison of empirical propagation path loss models for fixed wireless access systems”, in Vehicular Technology Conference, Spring 2005, Volume 1, pp. 73–77, 30 May – 1 June 2005.
- [26]V. Erceg, L.J. Greenstein, S.Y. Tjandra, S.R. Parkoff, A. Gupta, B. Kulic, A.A. Julius, R. Bianchi, “An Empirically Based Path Loss Model for Wireless Channels in Suburban Environments”, in IEEE Journal on Selected Areas in Communications, Volume 17, No. 7, July 1999.
- [27]M.J. Feuerstein, K.L. Blackard, T.S. Rappaport, S.Y. Seidel, H.H. Xia, “Path loss, Delay Spread, and Outage Models as Functions of Antenna Height for Microcellular System”, in IEEE Transactions on Vehicular Technology, Vol. 43, No 3, pp. 487-498, August 1994.
- [28]G.D. Durgin, T.S. Rappaport, and H. Xu, “Measurements and Models for Radio Path Loss In and Around Homes and Trees at 5.85 GHz”, in IEEE Transactions on Communications, Volume 46, No 11, pp. 1484–1496, November 1998.
- [29]J.W. Porter, I. Lisica, G. Buchwald, “Wideband mobile propagation measurements at 3.7 GHz in an urban environment”, in IEEE Antennas and Propagation Society International Symposium, Volume 4, pp. 3645–3648, 20-25 June 2004.
- [30]T. Rautiainen, K. Kalliola, J. Juntunen, “Wideband radio propagation characteristics at 5.3 GHz in suburban environments”, in Proc. IEEE 16th International Symposium on Personal, Indoor and Mobile Radio Communications, 2005, PIMRC 2005, Volume 2, pp. 868–872, 11–14 September.