



HAL
open science

Textile Architecture

Bernard Maurin, René Motro

► **To cite this version:**

Bernard Maurin, René Motro. Textile Architecture. Matériaux Composites Souples en Architecture, Construction et Intérieurs, Birkhauser, 13 p., 2013. hal-00856888

HAL Id: hal-00856888

<https://hal.science/hal-00856888>

Submitted on 6 Sep 2013

HAL is a multi-disciplinary open access archive for the deposit and dissemination of scientific research documents, whether they are published or not. The documents may come from teaching and research institutions in France or abroad, or from public or private research centers.

L'archive ouverte pluridisciplinaire **HAL**, est destinée au dépôt et à la diffusion de documents scientifiques de niveau recherche, publiés ou non, émanant des établissements d'enseignement et de recherche français ou étrangers, des laboratoires publics ou privés.

Textile architecture

Bernard Maurin 1, René Motro 1
1 LMGC Laboratoire de Mécanique et Génie Civil

1 Conceptual design process

The basic idea for a textile architecture project originates during early meetings between the architect and the engineer. The morphologic richness of such projects is provided by the varying curvatures of shapes, in contradiction with a classical straight line and orthogonal architecture. However the rules of construction are quite different in terms of realisation and of mechanical behaviour: textile membranes are subjected to a pre-stress conferring them their rigidity, and a major objective is to manage the coupling between internal forces and curvatures for a given material. This explains the necessity of collaborative work between architects and engineers from the early stages of the conceptual design process, in order to offer the best morphological expression while ensuring the feasibility of the project.

The first drawings are progressively formalised by the architect so as to define the overall shape and the main components, such as principal masts (1.1).

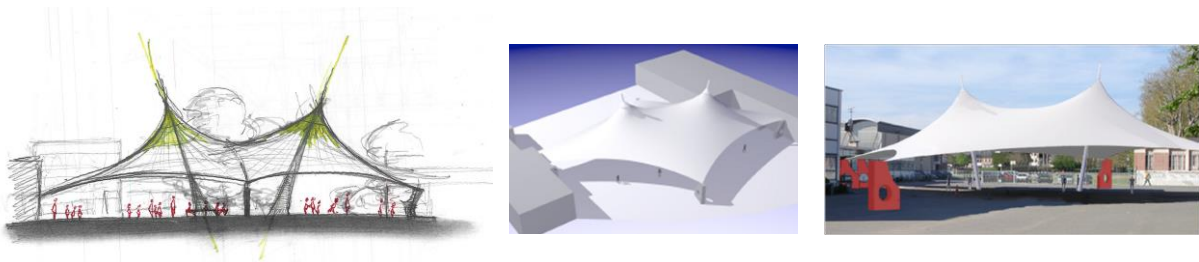

1.1 First drawings and sketches.

On the basis of these first drawings the engineer has to model the project, determining the shape by a so-called “form-finding process”, based on numerical methods. Several commercial or private software applications are available: all the fixed points have to be defined during this form-finding stage (fig. 1.2).

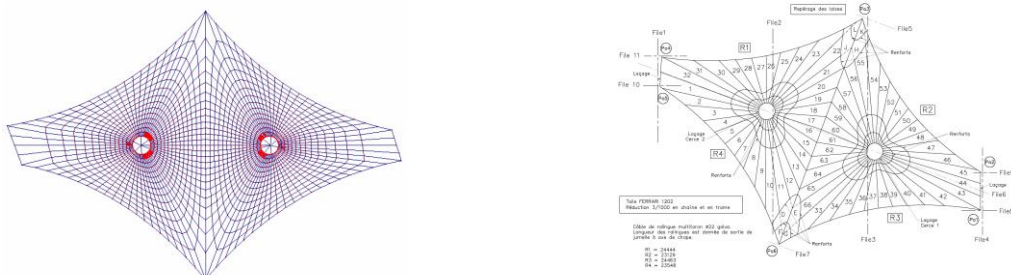

1.2 Form-finding process with dedicated software.

The sizing of the membrane is determined by a mechanical study under external actions that are defined by reference to current design rules. It must be underlined that climatic actions (wind and snow) are taken into account by combining their effects with those of the membrane pre-stress. A very important stage of the engineering study relies upon the so-called “cutting pattern”: the designer has to geometrically define geometrically the plane strips that will, once assembled, constitute the curved surface. Many criteria are taken into account, aesthetics, durability, but also those related to the orthotropic character of the textile. Several methods are used in order to reach a shape in accordance with the initial morphology,

not forgetting the importance of reducing the size of the strips. This size reduction will allow realisation of a pre-stress during assembly of the strips, in agreement with the level fixed during the mechanical behaviour calculations (fig. 1.3).

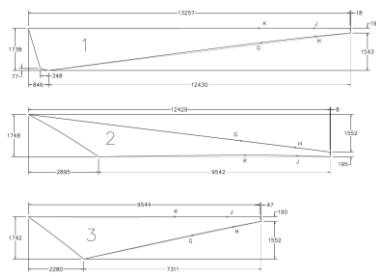

1.3 Cutting, welding and assembling the strips inside factory.

The membrane can then be transported to site, positioned, fixed to main masts and other anchoring points, before implementation of the calculated pre-stress allows the desired morphology to be realised (fig. 1.4).



1.4 Final realisation.

2 Basic engineering principles

Architectural textiles, when used for achieving shaped membranes, are under tension before the action of any external loads; this tension is known as initial pre-stress (also referred to as pretension). The overall membrane rigidity is further conditioned by its curvatures at any point. Curvature and pre-stress are characteristic of membrane design.

When compared to classical engineering studies, two specific main stages apply for membranes:

- the form-finding process enables the geometrical definition of their surfaces, which is closely coupled with the pre-stress distribution;
- the patterning stage is a geometrical definition of plane strips that will be assembled so as to realise the curved surfaces previously defined by the form-finding process.

Standard engineering analysis is then undertaken with a specific criterion; compression is not possible since it creates wrinkles. It should also be noted that the resultant effect of climatic actions and pre-stress is not an addition of their separate incidences but a combination, whose level is generally lower than their strict addition.

The membrane fabrication is also of great importance; how to design and size the plane strips so as to realise the designed shape when they are welded together and erected on site, is a major issue to solve.

Equilibrium of cables and membranes under load

Since it is possible to model a membrane by a cable net, it is useful to study the behaviour of a cable, which can only resist tension (the case of a rope in a tug of war). Without tension the cable is in a slackened state; losing its straight shape, which would give rise to wrinkles in the modelled membrane.

Theoretically speaking, straight horizontal cables cannot resist a vertical force (F) while beams can do so by flexion (fig. 1.5).



1.5 Cables and beam: tension T would be infinite for cables.

However it is possible to resist a vertical force with cables using a so-called “V shape”. This V shape for cables is equivalent to the curvature of membranes. Curvature is dependant on the value of the initial angle α . If α increases, the tension decreases ($T_2 < T_1$) and since the associated cable deformation decreases, the stiffness increases (fig. 1.6). By analogy a flat, or nearly flat, membrane has zero or very low stiffness. Curvature is therefore necessary for stiffness, and in consequence local codes impose minimum values.



1.6 V-shape as elementary curved geometrical model.

Curvature

The definition of a single curvature for a plane curve C_p is based on the properties of the circle defined by three points M , M' and M'' on this curve. Geometrically speaking it can be established that when M' and M'' get closer to M there is a unique circle of radius R that shares the same tangent line with the curve (fig. 1.7).

R is the radius of curvature of the curve at point M and $\rho = 1/R$ is the curvature. If R increases, ρ decreases (e.g. a flat curve has a zero curvature, R is infinite). The curvature is defined for each point of C_p .



1.7 Curvature of a curve C_p at a point M .

For a spatial case like membrane surfaces, it is usual to define their “double curvature” at every point.



1.8 Double curvature of a surface at any point M.

If we consider a curved surface S intersected by a plane P_1 , it is possible to define the curvature of the resulting curve C_p (radius R being defined as previously at point M for a single plane curve) (fig. 1.8 a).

According to the theory of geometry, there exist only two orthogonal planes P_1 and P_2 for which R_1 (in P_1) is maximal and R_2 (in P_2) is minimal (Fig. 1.8 b). Planes P_1 and P_2 define the directions of the main curvatures; R_1 and R_2 are the corresponding main radii of curvatures.

The parameter $K = 1/R_1 \times 1/R_2 (= \rho_1 \times \rho_2)$ is the total curvature at point M . If the centres of circles of radii R_1 and R_2 are not at the same side of the surface, it is an anticlastic shape (double negative curvature with $K < 0$). If the centres of circles are at the same side of the surface, it is a synclastic one (double positive curvature, $K > 0$).

Pretension

Let us consider two cables of initial length equal to l_0 . One of their ends is pinned and they are assembled at their other end, having now a length l . Since l is greater than l_0 , it is necessary for assembling to introduce a deformation in the cables by lengthening them and, consequently, introducing a pretension in the cables. When a force F is applied at the junction node, both cables initially contribute to the equilibrium, until a critical value of the displacement v equal to $l-l_0$ (situation A in fig. 1.9). After this specific value the lower cable slackens and no longer contributes to the equilibrium (situation B in fig. 1.9). The stiffness (force divided by the displacement, i.e. the slope of the line) in situation B is half that of A.

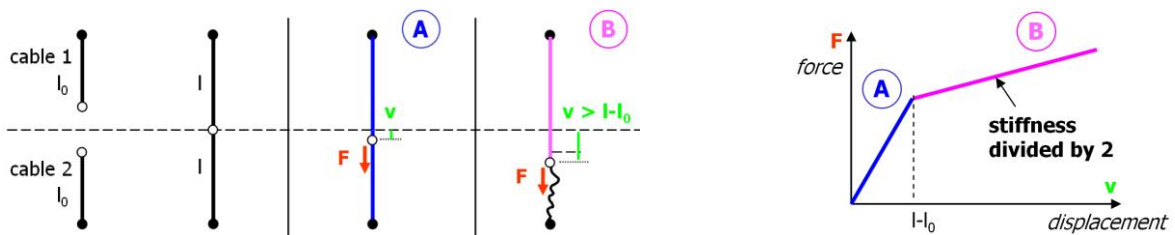

1.9 Pretension: case of a bi-cable.

Combination of pretension and curvature

For every point of an anticlastic membrane, it is possible to model the double curvature with two inverted V shapes (AMB and CMD in fig. 1.10) under pretension with the stiffness ensured in every direction.

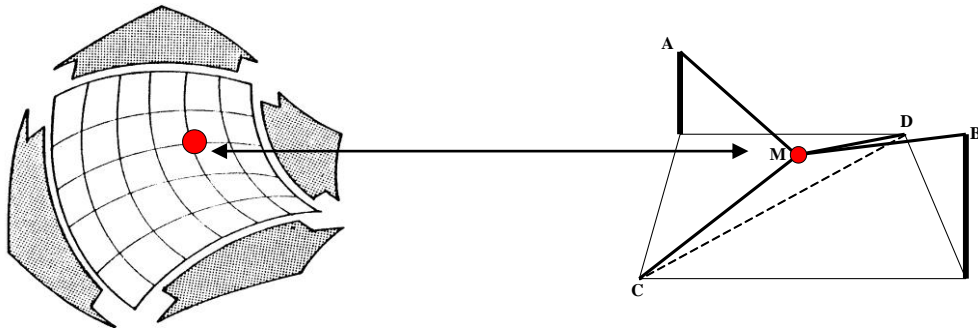

1.10 Anticlastic surface and modelling of double curvature at any point.

A coupled action of curvature and pretension is then possible in order for efficient behaviour when combined with the effects of climatic actions. Local codes can impose a minimum value for the level of pretension. However, since it will be the only permanent action in the membrane, a maximum value should be considered in accordance with the fabric's tensile and fatigue strength. In practice, tension ranges from 100 to 300 daN/m.

It is out of the scope of this chapter to give more information on the relationship between pretension values and radii of curvature, but interested readers can refer to scientific literature (see bibliography on page XX).

3 Form-finding

How to determine the surface shape of a membrane fixed at prescribed points and/or lines remained a difficult question during many years¹. It is simultaneously necessary to introduce a pre-stress, whose level must be managed so as to avoid wrinkling or excessive tensions, while providing sufficient stiffness against climatic actions. The designer wishes also to evacuate water and has to verify the effective slope everywhere, keeping in mind the desired aesthetic.

The first step is to specify the anchoring points and lines: top of a mast, fixed points (on the ground, on a wall...), straight lines, circular lines (top ring) and perimeter for pneumatic membranes. Once these boundary conditions are defined, the form-finding process is performed with two main objectives: the surface definition and the pretension distribution, while not forgetting the design constraints.

Designers began to use known morphogenesis methods based on classical geometry and physical models ("historical models"). Nowadays, even if physical models are acceptable for preliminary studies, "numerical methods" are in current use.

Analogue methods

Since the main constraint is to have a double curved synclastic surface for classic membranes (anticlastic for pneumatic ones), designers could use geometrical strategies:

- combination of known surfaces;
- displacement of curves (one being called "director line", the other "generator line");
- analytical methods (e.g. equation of the sphere or use of "splines" - curves that were used for naval architecture or the car industry).

Pioneers like Frei Otto worked with physical models, mainly with soap surfaces existing in a boundary frame² (fig. 1.11). These films under surface tension are of great interest since they are of minimum area and a quasi-homogenous state of pre-stress, consequently meeting the design constraints. It must however be underlined that the geometrical reproduction of the soap films was difficult (photogrammetry was used for some models) and that the associated morphological register was restricted, leading designers to look for other approaches.

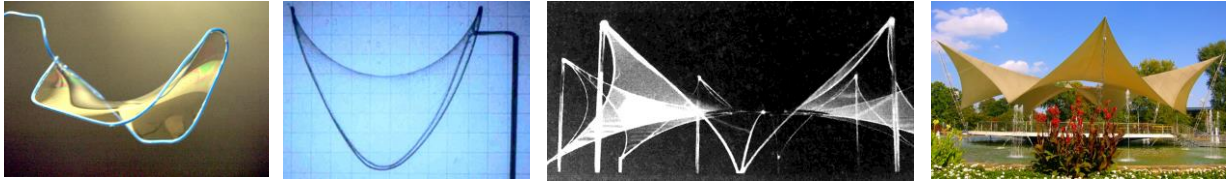

1.11 Form finding with soap films (IL Stuttgart).

Another method was to create physical models using textile (fig. 1.12). Even if they are quite impossible to transfer into a precise geometrical definition, they offer advantages like direct visualisation and the possibility of directly patterning on the model. They are still commonly used at the very early stages of design.



1.12 Physical models with Lycra.

Numerical methods

Several numerical methods were then developed to overcome the drawbacks of physical models. K. Linkwitz, involved in the Munich Olympic stadium project with Frei Otto (1972, fig. 1.13) proposed the “Force Density Method” (FDM) that he developed with H.J. Schek³. He modelled the membrane by a tensile cable net and designed it using FDM, which allows solving the equilibrium equations by a prescribed linearisation: the engineer chooses the “force density coefficients” (tension/length ratio for each cable element connected to a net node).

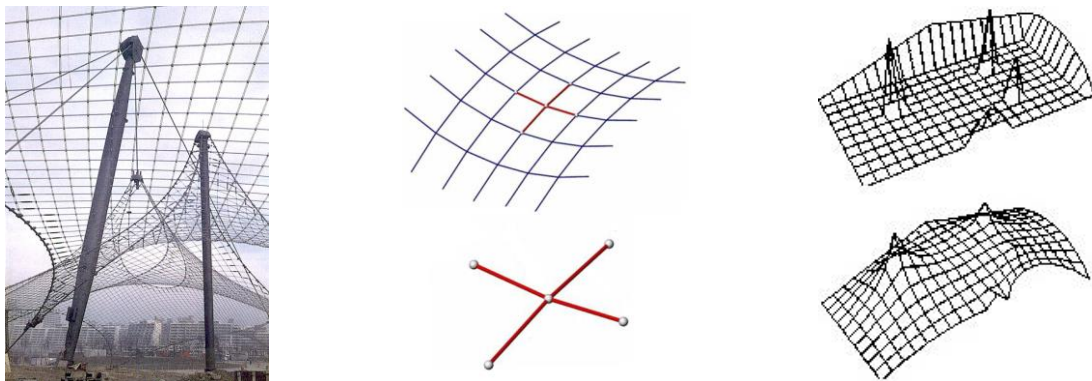

1.13 Force density method for cable nets form-finding.

For identical boundary conditions, different choices of these coefficients result in various shapes. This user-friendly method was quickly imported for tensile membrane form-finding, even if there exist some differences: distinction between the geometry of a tensile cable net and a tensile membrane, sensitivity to anchoring conditions, tension calculation in cable elements but not in a membrane. Some improvements were hence submitted such as the “surface density method”.

Another popular method, introduced by M. Barnes, is that of “Dynamic Relaxation” (DR)⁴. It allows solving the equilibrium equations by calculating a damped geometry in a dynamic process considering a so-called “kinetic damping”. A key feature of this method is that it is based on a surface modelling of the membrane and it gives to the designer a control on the pre-stress, for example to specify a uniform tension state (soap film).

A more classical method, the “Finite Element Method” (FEM), can also be used for surface modelling⁵. Two strategies are available:

- An initial shape “close to” the chosen one is prescribed and progressively modified by displacement of anchoring conditions. It is however difficult to evaluate the obtained form and tensions (resulting shape not always satisfying: for instance, the existence of compressive areas) and this may require large calculation times;
- An initial shape is prescribed with a specification of the tension distribution. Here also, it is difficult to evaluate the obtained form and it is necessary to assess whether the tensions are compatible with an equilibrated shape.

Another efficient approach, also based on a surface modelling of the membrane and called “Update Reference Strategy”, has been developed more recently by K.U. Bletzinger⁶.

4 Patterning

Like clothes that are the result of the assembly of cut plane pieces of fabric, the realisation of the membrane resulting from the form-finding process requires the definition of plane cut pieces. This definition is complex since many parameters must be taken into account. The first one is relative to the spatiality of the form: cutting lines are prescribed on a tridimensional shape to generate intermediate “strips”. These strips are however not planar, and must be “flattened”, since the fabricator has to cut them out of manufactured fabric rolls. Moreover, to satisfy the required pre-stress, they must be reduced before the final assembly by thermo-welding. This size reduction requires a very good knowledge of the geometric parameters and the mechanical characteristics of the fabric, itself an orthotropic material. An incorrect pattern definition may lead to wrinkles and areas of insufficient pre-stress. Even if several software applications are helpful in this operation, the designer’s skill and experience remains the main guarantee of its success.

Three operations are included in the patterning process: choice of the seam lines, flattening of a curved strip, tension compensation by size reduction.

Seams

In order to manipulate seams and cutting lines the designer has to play with many parameters that can be classified according to the following enumeration:

- technology: size of textile rolls (1.8 m wide for example), manufacturer’s equipment (welding devices);
- cost: a higher number of seams will result in better accuracy but also in a higher waste of fabric in the cut;
- geometry: the total curvature represents the difficulty of developing the surface onto a plane. A high curvature in a zone may hence lead to smaller panels;
- mechanics: a good knowledge of the main stress directions under loading is necessary to guide the positioning of the warp and weft directions (higher strength and rigidity in warp). Singular zones, mainly at boundaries may also govern the choice (connection to membrane edge cables or rigid rings, etc.). A common configuration uses radial strips (fig. 1.14 a);
- fabric behaviour: it is characterised by its orthotropic composition;
- aesthetics: the consequent visual rhythm is generally central for the architect (fig. 1.14 b).

The final choice is the result of compromises between all these parameters. Practically speaking, two main strategies are used to determine the seam lines:

- use of geodesic lines (shortest path between two points, the equivalent of “straight line” on a curved surface);
- use of intersecting planes (e.g. vertical cut of surfaces).

The designer has also to be cautious when major pieces are assembled since the number and size of strips on the connecting lines have to be equal.

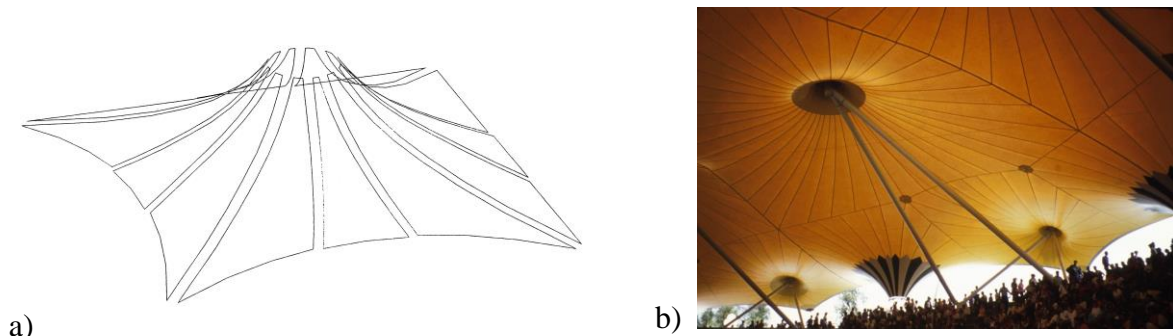

1.14 Radial strips; membrane for a Delphinarium (Parc Asterix, Paris).

Flattening

The objective is to determine the plane unfolded form of the strip (2D strip development) corresponding to the tridimensional strip defined on the surface after form-finding.

The variation of the total curvature K , previously defined as a geometric characteristic of surfaces, implies that there is no theoretical exact solution for double curved membranes. The difference of K values shows the difficulty to transform a curved surface into a plane one and vice-versa. With a flat sheet of paper it is possible to generate a cone or any other developable surface but it is impossible to create a sphere. The example of the maps that were proposed for the Earth demonstrates this impossibility. Since there is no exact solution, different maps exist:

- Equivalent flattening (preserves areas);
- equidistant flattening (preserves lengths);
- conformal flattening (preserves angles: case of Mercator’s map).

Nevertheless, it is impossible to have simultaneously the areas and lengths preservation for a non-developable surface. The designer has thus to face the difficulty to transform a curved strip into a plane surface in an operation known as “flattening”. Several approaches based on various optimisation techniques can be used (different approaches to minimise errors). It can be said that flattening causes more errors than form-finding. The simplest way is to use a simple triangulation (fig. 1.15).

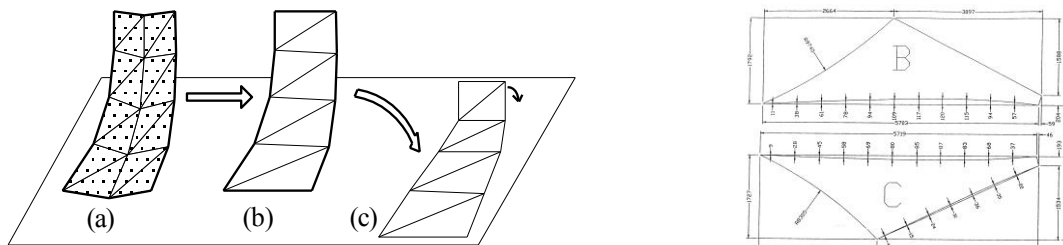

1.15 Flattening by simple triangulation.

Compensation

If the strip sizes were strictly equal to the dimensions measured on the surface, the assembly of strips would not be in pretension after installation on site. It is consequently necessary to reduce the size of the strip; this in a “compensation” stage. It requires taking into account many factors:

- knowledge of the tension distribution (values defined in the form-finding) and textile behaviour (mechanical parameters in warp and fill directions: use of bi-axial tests);
- warp and weft compensation (0.2 to 5%) may be not identical and the orientation of the fabric relatively to seams is important;
- possible local compensation and de-compensation (depends on the context).
- long term behaviour and associated deformation: variation of tension in-situ (a re-tensioning after several months is generally necessary).

It clearly appears that the patterning stage is critical for the design. It may produce errors in terms of seam determination, strip flattening and compensation, possibly resulting in difficulties in the erection and appearance of un-aesthetic wrinkles, but can also induce bad mechanical behaviour due to an inappropriate state of pretension.

5 Load analysis

As for any construction the engineer has to proceed to a mechanical analysis of the membranes under actions. The main external actions are climatic ones (wind and snow) and they will be combined with the effect of the internal pre-stress. Several indications result from this analysis:

- membrane deformation: governs the maximum deflection (generally limited by local codes);
- maximum membrane stress: determines the minimum fabric strength (and consequently validates the textile “type”);
- direction of membrane stresses: important cue for seam line positioning and contiguous strip welding;
- edge cables maximum internal forces: allows choice of the minimum cable diameters;
- forces exerted on supports: required to size and design the main structural components (compressed masts and stays, bended beams, anchoring, etc.).

The interaction between double curvature and pretension is taken into account at the design stage. The two directions of curvature play a role in balancing either wind or snow actions. The deformation of the membrane under a specified action induces variations in the pretension (fig. 1.16):

- the tension increases in one direction and decreases in the other one;
- if the membrane remains tensioned along these two directions, they both contribute to the stiffness;
- problems occur when the lower tension reaches a zero value: wrinkles appear and lead to membrane instability.

Normally, the pre-stress level ensures the absence of wrinkling. It could however occur for the case of high climatic actions (storm).

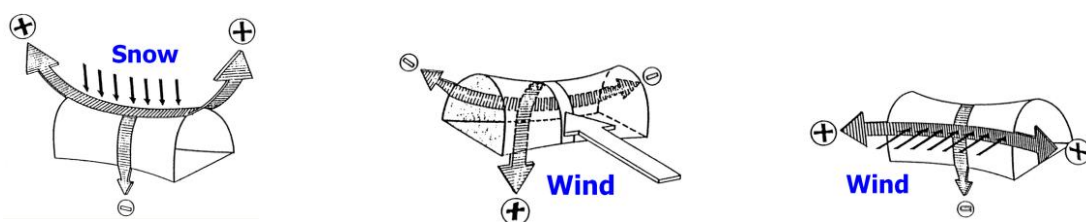

1.16 Schematic equilibrium of climatic actions according to the double curvature.

A textile membrane's stiffness is of course inferior to those of steel or concrete components. It is also dependent on the pre-stress level. Moreover, since displacements can be of high value, it is necessary to proceed to a "geometrical" non-linear analysis.

The non-linear behaviour of the textile necessitates in addition, actualising the stiffness to the deformation ("material" non linear analysis).

Consequently a non-linear analysis is always required, using a numerical iterative process (load is applied "step by step" in an incremental way)

Calculation under snow

Snow is considered as a vertical load, uniformly distributed on the surface if there is no interaction with wind (no movement of snow over the membrane). The minimum values to be considered are prescribed by local codes.

There is no intricate difficulty to numerically calculate the behaviour under snow provided that there is no membrane wrinkling to generate instabilities.

Calculation under wind

The effect of wind, considered as a fluid, is always perpendicular to the surface, but the interaction between the wind and the shape of the structure generates zones under pressure and zones under suction. As for a conventional building, it is necessary to have a cartograph of the external pressure coefficients C_e for the outside faces of the building; that will be combined with the effect of the wind inside the building (e.g. wind uplift) characterised by internal pressure coefficients C_i .

It is however generally difficult to evaluate this interaction between the membrane and the wind. Various approaches are available to evaluate the coefficients C_e and C_i :

- wind tunnel testing on models (good but onerous solution; scale effects can be sources of errors);
- empirical estimation of the resulting membrane coefficient C_e-C_i (depending on the engineer's experience);
- constant C_e-C_i values on the membrane (only acceptable if it results in a secure situation: the most unfavourable situation);
- computer calculation of C_e-C_i by dedicated software (this however necessitates a careful assessment of the result).

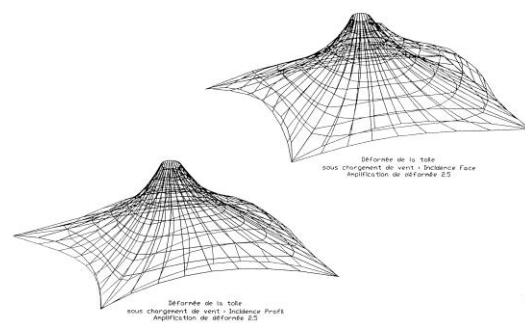
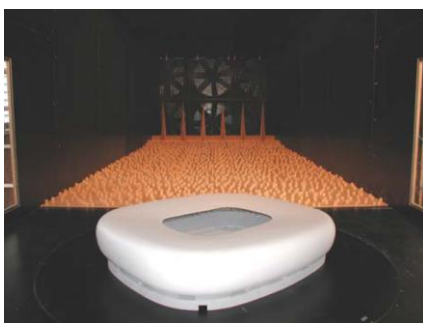

1.17 Study of wind effect (wind tunnel and cable net model).

Additional loadings

Other load cases are sometimes studied, such as dynamic earthquake analysis or natural wind vibrations. Specific assumptions are also necessary for the design of inflatable membranes (constant pressure or constant volume, etc.). Erection procedure may also require

a specific study if it generates dangerous mechanical situations; this is mainly dependant on the local context.

Textile membrane design requires specific expertise from the designers at all stages: first sketches, form-finding, patterning and load analysis require close collaboration between architects and engineers. This partnership generally provides satisfying results in terms of architecture and cost.

¹ Motro, R., Maurin, B., “Membranes textiles architecturales. Comportement mécanique des systèmes tissés”, Hermès Ed., p. 17-70, 2006.

² Otto, F., “Tensile Structures”, vols 1 and 2, MIT, Cambridge, MA, 1973.

³ Linkwitz, K., Schek, H.J., “Einige Bemerkungen zur Berechnung von vorgespannten Seilnetzkonstruktionen”, Ingenieur-Archiv 40, Springer-Verlag, p. 145-158, 1971.

⁴ Barnes, M.R., “Applications of Dynamic Relaxation to the Design and Analysis of Cable, Membrane and Pneumatic Structures”, 2nd International Conference on Space Structures, Guildford, 1975.

⁵ Haug, E., Powell, G.H., “Finite Element Analysis of Nonlinear Membrane Structures”, IASS Pacific Symp. on Tension Structures and Space Frames, Tokyo and Kyoto, p. 124-135, 1972.

⁶ Haber, R.B., Abel, J.F., “Initial Equilibrium Solution Methods for Cable Reinforced Membranes – Part I and II”, Computer Methods. Applied Mech. Eng., vol. 30, p. 263-89 and p. 285-306, 1982.

⁶ Bletzinger, K.U., Ramm, E., “A General Finite Element Approach to the Form Finding of Tensile Structures by the Updated Reference Strategy”, International Journal of Space Structures, vol. 14, p. 131-246, 1999.