



**HAL**  
open science

## The variational theory of complex rays for the calculation of medium-frequency vibrations

Pierre Ladevèze, Lionel Arnaud, Philippe Rouch, Claude Blanzé

► **To cite this version:**

Pierre Ladevèze, Lionel Arnaud, Philippe Rouch, Claude Blanzé. The variational theory of complex rays for the calculation of medium-frequency vibrations. *Engineering Computations*, 2001, vol. 18, pp. 193-214. 10.1108/02644400110365879 . hal-00854453

**HAL Id: hal-00854453**

**<https://hal.science/hal-00854453>**

Submitted on 27 Aug 2013

**HAL** is a multi-disciplinary open access archive for the deposit and dissemination of scientific research documents, whether they are published or not. The documents may come from teaching and research institutions in France or abroad, or from public or private research centers.

L'archive ouverte pluridisciplinaire **HAL**, est destinée au dépôt et à la diffusion de documents scientifiques de niveau recherche, publiés ou non, émanant des établissements d'enseignement et de recherche français ou étrangers, des laboratoires publics ou privés.



## Open Archive Toulouse Archive Ouverte (OATAO)

OATAO is an open access repository that collects the work of Toulouse researchers and makes it freely available over the web where possible.

This is an author-deposited version published in: <http://oatao.univ-toulouse.fr/>  
Eprints ID: 6545

**To link to this article:** DOI:10.1108/02644400110365879  
<http://www.emerald-library.com/journals.htm?issn=0264-4401&volume=18&issue=1/2&articleid=878108&show=abstract>

**To cite this version:**

Ladevèze, Pierre and Arnaud, Lionel and Rouch, Philippe and Blanzé, Claude  
*The variational theory of complex rays for the calculation of medium-frequency vibrations*. (2001) *Engineering Computations*, vol. 18 (n° 1-2). pp. 193-214.  
ISSN 0264-4401

Any correspondence concerning this service should be sent to the repository administrator:  
[staff-oatao@inp-toulouse.fr](mailto:staff-oatao@inp-toulouse.fr)

# The variational theory of complex rays for the calculation of medium-frequency vibrations

P. Ladevèze, L. Arnaud, P. Rouch and C. Blanzé  
*LMT Cachan, ENS Cachan/CNRS,  
Université Paris 6, Cachan, France*

**Keywords** *Vibration, Variable frequency, Plate structures*

**Abstract** *A new approach called the “variational theory of complex rays” (VTCR) is developed for calculating the vibrations of weakly damped elastic structures in the medium-frequency range. Here, the emphasis is put on the most fundamental aspects. The effective quantities (elastic energy, vibration intensity, etc.) are evaluated after solving a small system of equations which does not derive from a finite element discretization of the structure. Numerical examples related to plates show the appeal and the possibilities of the VTCR.*

## Introduction

The modeling and calculation of the vibrational response of elastic structures are undoubtedly among the key issues arising in the design of structures. The low-frequency range no longer poses major difficulties, even for complex structures, at least with respect to modeling and calculation. Concerning high frequencies, there do exist computational tools which are quite distinct from those utilized for low frequencies, and particularly from the SEA method in which the spatial aspect disappears almost entirely (Lyon and Maidanik, 1962; Lyon *et al.*, 1995; Mace, 1994; Dowell and Kubota, 1985).

In contrast, the modeling and calculation of medium-frequency vibrations, on which this paper focuses, continue to raise certain problems. The difficulty is that the length of variation of the phenomena studied is very small compared to the structure's characteristic dimension. It follows that, if one were to extend the low-frequency methods, aside from the serious numerical difficulties already present, the finite element calculation to be conducted would require an unreasonable number of degrees of freedom. Nevertheless, much work is in progress in order to extend the calculated frequency range. A first result is that a pollution error affects the accuracy of the finite element solution (Deraemaeker *et al.*, 1999; Bouillard and Ihlenburg, 1998; Ihlenburg and Babuska, 1995). Various enhanced finite element approaches have been studied, and in particular: Babuska *et al.* (1995), Ihlenburg and Babuska (1997), Harari *et al.* (1996), Buvailo and Ionov (1980), Barbone *et al.* (1998), Wiberg *et al.* (1996), Demkowicz *et al.* (1992), Harari and Haham (1998), Harari and Hugues

---

The work reported here is part of a research programme sponsored by Aerospatiale-Matra, Alcatel, DGA and PSA. This support is gratefully acknowledged

(1992), Greenstadt (1999), Grosh and Pinsky (1998), Wu and Ginsberg (1998), Yoon Young and Jaeong Hoon (1996), Zielinski and Herrera (1987), Leung and Chan (1998), Liu *et al.* (1991), Rizzo *et al.* (1985), Rosenhouse *et al.* (1997). Difficulty would also be experienced in extending the SEA method, which is appropriate for high frequencies.

Little other work is aimed at the calculation of medium-frequency vibrations. For rods and beams the problem is much easier and has been solved, in particular, in Cuschieri (1990), Girard and Defosse (1993), Nefske and Sung (1989). Very little work concerns complex structures, such as plates or shells: Morand (1992), de Langre (1991), Soize (1985; 1998), Ochmann and Makarov (1998), Bouthier and Bernhard (1995). Strongly related to finite element methods, these propose specific reduced bases (space and frequency bandwidth) for the medium-frequency calculation. With the exception of the theory introduced in Belov and Ryback (1975; 1977), these methods are not, in our opinion, true “medium-frequency” methods because the phenomena associated with small-length variations, although not highly significant, do remain present. In other words, these methods do not strictly involve the “effective” quantities for the time and space scales considered and, therefore, give results which are very sensitive to data errors. The theory initiated in Belov and Ryback, (1975) is built upon the notions of “effective energy density” and “effective vibrational energy”. This heuristic theory is extremely attractive; however, despite the improvements made, notably by Ichchou *et al.* (1997), Lase *et al.* (1994), Luzzato (1989), Bouthier and Bernhard (1995), this theory still contains some obstacles that are difficult to circumvent (Ladevèze, 1995; Langley, 1995).

The alternative approach developed here is entitled “Variational theory of complex rays” and was introduced in Ladevèze, (1996a; 1996b). It is also a true “medium-frequency” method. The goal of this paper is to present the main principles which characterize the VTCR and to illustrate its possibilities and limits on some numerical examples related to plates. In order to simplify the presentation, we will consider only the basic problem, which is to calculate forced vibrations for a given frequency. Also, again for the sake of simplicity, we will restrict ourselves to the 2D forced vibration problem in elasticity.

The first feature (P1) which characterizes this approach is the use of a new variational formulation of the reference problem. We developed it in order to allow within the substructures approximations which are a priori independent, or, in other terms, which do not necessarily satisfy a priori the transmission conditions at the interfaces between the substructures, with respect to both displacements and stresses. These conditions are incorporated into the variational formulation.

The second feature (P2) defining this approach is the introduction of two-scale approximations with a strong mechanical content: the solution is assumed to be well- described locally in the vicinity of a point  $\underline{X}$  as the superposition of an infinite number of local vibration modes. These basic

modes (which can be interior modes, boundary modes or corner modes) satisfy the laws of dynamics. All wave directions are taken into account; the unknowns are discretized amplitudes for which the wavelength is rather large.

The last feature (P3) characterizing the VTCR is that we retain from the calculated discretized amplitudes only effective quantities related to the elastic energy, the kinetic energy, the dissipation work, etc. Emphasis was put on the most fundamental aspects. The VTCR does, in fact, enable the derivation of the exact solution for rods and beams. It was applied here to plates, for which more details will be given in a companion paper.

### Basic aspects of the VTCR

#### Reference problem

In order to simplify the presentation, the problem will be formulated for an assembly of two structures, but it can easily be generalized to the case of  $n$  structures. Given two structures  $S$  and  $S'$ ,  $\partial S$  and  $\partial S'$  represent the boundaries of  $S$  and  $S'$  respectively. We study the harmonic vibration of these two structures at a fixed frequency  $\omega$ . All quantities can be defined in the complex domain: to an amplitude  $\underline{Q}(\underline{X})$  corresponds  $\underline{Q}(\underline{X}) \cdot \exp(i\omega t)$ .

All quantities related to  $S'$  will be designated by " ' ". The environmental actions on  $S$  are represented in Figure 1:

- a displacement field  $\underline{U}_d$  over part  $\partial_1 S$  of the boundary  $S$ ;
- a force density  $\underline{F}_d$  over part  $\partial_2 S$ ; and
- a force density  $\underline{f}_d$  over the whole domain  $S$ .

Equivalent quantities are defined on  $S'$ .

Let us define for the structure  $S$  the field  $\mathbf{S}_{ad}$  of couples  $s = (\underline{U}, \boldsymbol{\sigma})$  such that:

$$\begin{aligned}
 \underline{U} &\in \mathbf{U} && \text{(finite-energy displacement set),} \\
 \boldsymbol{\sigma} &\in \mathbf{S} && \text{(finite-energy stress set),} \\
 \underline{\Gamma} &= \operatorname{div} \boldsymbol{\sigma} + \underline{f}_d \text{ on } S, \\
 \boldsymbol{\sigma} &= (l + i\eta) \mathbf{K} \boldsymbol{\varepsilon}(\underline{U}) && \underline{\Gamma} = -\omega^2 \rho (l - i\theta) \underline{U},
 \end{aligned} \tag{1}$$

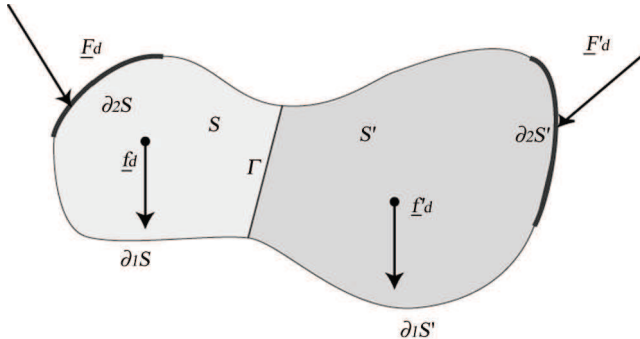

**Figure 1.**  
Problem definition

where  $\mathbf{K}$  is Hooke's operator,  $\rho$  the density and  $\theta$  and  $\eta$  are the (frequency-dependent) damping coefficients. The subspace of  $\mathbf{T} \equiv \mathbf{U} \otimes \mathbf{S}$  associated with the homogenized conditions ( $\underline{f}_d = 0$ ) is designated by  $\mathbf{S}_{ad,0}$ . Similarly, we introduce  $\mathbf{S}'_{ad}$  and  $\mathbf{S}'_{ad,0}$ .

The problem to be solved can be formulated in the following manner:

Find  $\{(\underline{\mathbf{U}}(\underline{\mathbf{X}}), \underline{\boldsymbol{\sigma}}(\underline{\mathbf{X}})); \underline{\mathbf{X}} \in S\}$  and  $\{(\underline{\mathbf{U}}'(\underline{\mathbf{X}}), \underline{\boldsymbol{\sigma}}'(\underline{\mathbf{X}})); \underline{\mathbf{X}} \in S'\}$  such that:

$$\begin{aligned} s &= (\underline{\mathbf{U}}, \underline{\boldsymbol{\sigma}}) \in \mathbf{S}_{ad} & s' &= (\underline{\mathbf{U}}', \underline{\boldsymbol{\sigma}}') \in \mathbf{S}'_{ad} \\ \underline{\boldsymbol{\sigma}} \underline{\mathbf{n}}_{\partial_1 S} &= \underline{\mathbf{F}}_d & \underline{\boldsymbol{\sigma}} \underline{\mathbf{n}}_{\partial_2 S} &= \underline{\mathbf{F}}_d \\ \underline{\boldsymbol{\sigma}}' \underline{\mathbf{n}}'_{\partial_1 S'} &= \underline{\mathbf{F}}'_d & \underline{\boldsymbol{\sigma}}' \underline{\mathbf{n}}'_{\partial_2 S'} &= \underline{\mathbf{F}}'_d \\ (\underline{\mathbf{U}} - \underline{\mathbf{U}}')_{\Gamma} &= \underline{\mathbf{0}} & (\underline{\boldsymbol{\sigma}} \underline{\mathbf{n}} + \underline{\boldsymbol{\sigma}}' \underline{\mathbf{n}}')_{\Gamma} &= \underline{\mathbf{0}}. \end{aligned} \quad (2)$$

*The variational formulation associated with the VTGR*

The VTGR is primarily a global formulation of the boundary conditions (2) in displacement as well as in force.

The initial feature (P1) used to characterize it is the use of a priori independent approximations within the substructures:

Find  $(\underline{\mathbf{U}}, \underline{\boldsymbol{\sigma}}) \in \mathbf{S}_{ad}$  and  $(\underline{\mathbf{U}}', \underline{\boldsymbol{\sigma}}') \in \mathbf{S}'_{ad}$  such that:

$$\text{Re} \left\{ -i\omega \left[ \int_{\partial_1 S} \delta \underline{\boldsymbol{\sigma}} \underline{\mathbf{n}} (\underline{\mathbf{U}}^* - \underline{\mathbf{U}}_d^*) d\tau + \int_{\partial_2 S} (\underline{\boldsymbol{\sigma}} \underline{\mathbf{n}} - \underline{\mathbf{F}}_d) \delta \underline{\mathbf{U}}^* d\tau + \int_{\partial_1 S'} \delta \underline{\boldsymbol{\sigma}}' \underline{\mathbf{n}}' (\underline{\mathbf{U}}'^* - \underline{\mathbf{U}}_d'^*) d\tau + \int_{\partial_2 S'} (\underline{\boldsymbol{\sigma}}' \underline{\mathbf{n}}' - \underline{\mathbf{F}}'_d) \delta \underline{\mathbf{U}}'^* d\tau + \frac{1}{2} \int_{\Gamma} (\delta \underline{\boldsymbol{\sigma}} \underline{\mathbf{n}} - \delta \underline{\boldsymbol{\sigma}}' \underline{\mathbf{n}}') (\underline{\mathbf{U}}^* - \underline{\mathbf{U}}'^*) + (\underline{\boldsymbol{\sigma}} \underline{\mathbf{n}} + \underline{\boldsymbol{\sigma}}' \underline{\mathbf{n}}') (\delta \underline{\mathbf{U}}^* + \delta \underline{\mathbf{U}}'^*) d\tau \right] \right\} = 0$$

$$\forall \delta s = (\delta \underline{\mathbf{U}}, \delta \underline{\boldsymbol{\sigma}}) \in \mathbf{S}_{ad,0} \quad \forall \delta s' = (\delta \underline{\mathbf{U}}', \delta \underline{\boldsymbol{\sigma}}') \in \mathbf{S}'_{ad,0}, \quad (3)$$

where "Re[A]" designates the real part of  $A$  and " $A^*$ " designates the conjugate of  $A$ .

*Theorem 1.* This new formulation is equivalent to the reference problem (2) if:

- (1) Problem (2) has a solution.
- (2) Hooke's tensors are positive definite. (4)
- (3) The damping factors are greater than or equal to zero.

*Remarks.* The quantities used in this formulation are powers. This formulation is an extension to dynamic problems of a formulation proposed by Ladevèze (1981) for the static case. In fact, it is an extension of the variant developed by Hochard *et al.* (1993).

Contrary to usual formulations, displacements and forces may be applied at the same time on the same boundary. In this case, the following quantity should be considered:

$$\frac{1}{2} \text{Re} \left\{ -i\omega \left[ \int_L \delta \boldsymbol{\sigma} \underline{n} (\underline{U}^* - \underline{U}_d^*) + (\boldsymbol{\sigma} \underline{n} - \underline{E}_d) \delta \underline{U}^* d\tau \right] \right\}. \quad (5)$$

Damping plays a major role in the new formulation. Let us introduce for substructure  $S$  the dissipated power, which is defined by:

$$E_D(\underline{U}) = \frac{\omega^3}{2} \int_S \rho \theta \underline{U} \cdot \underline{U}^* dS + \frac{\omega}{2} \int_S \eta \text{Tr}[K \boldsymbol{\sharp}(\underline{U}) \boldsymbol{\sharp}(\underline{U}^*)] dS. \quad (6)$$

A similar quantity is defined for  $S'$ .

It is thus possible to write the new formulation as: find  $s \in S_{ad}$  and  $s' \in S'_{ad}$  such that:

$$\begin{aligned} \delta[E_D(\underline{U}) + E'_D(\underline{U}')] + \left\langle \begin{bmatrix} s \\ s' \end{bmatrix}, \delta \begin{bmatrix} s \\ s' \end{bmatrix} \right\rangle &= \left( L_d, \delta \begin{bmatrix} s \\ s' \end{bmatrix} \right) \\ \forall \delta s \in \mathbf{S}_{ad,0} \quad \forall \delta s' \in \mathbf{S}'_{ad,0}, & \end{aligned} \quad (7)$$

where  $L_d$  is a linear form and  $\langle \bullet, \bullet \rangle$  is a bilinear form defined on the substructure boundaries. The latter's main property is:

$$\langle u, v \rangle = - \langle v^*, u^* \rangle, \quad (8)$$

The symmetrical part of the linear operator associated with the new formulation depends strongly on the damping factors. As a consequence of equations (7) and (8), the dissipated power is:

$$E_D(\underline{U}) + E'_D(\underline{U}') = \frac{1}{2} \left( L_d, \begin{bmatrix} s \\ s' \end{bmatrix} \right). \quad (9)$$

## Approximations

### Principle

All that is necessary, in order to develop approximations from the VTCR, is to define the subspaces  $\mathbf{S}_{ad}^h$  and  $\mathbf{S}_{ad,0}^h$  (resp.  $\mathbf{S}_{ad}^{h'}$  and  $\mathbf{S}_{ad,0}^{h'}$  from  $\mathbf{S}_{ad}$  and  $\mathbf{S}_{ad,0}$  (resp.  $\mathbf{S}'_{ad}$  and  $\mathbf{S}'_{ad,0}$ ). Under the conditions (4), the approximated formulation can be written as: find  $s^h = (\underline{U}^h, \boldsymbol{\sigma}^h) \in \mathbf{S}_{ad}^h$  and  $s^{h'} = (\underline{U}^{h'}, \boldsymbol{\sigma}^{h'}) \in \mathbf{S}_{ad,0}^{h'}$  such that:

$$\begin{aligned} \delta[E_D(\underline{U}^h) + E'_D(\underline{U}^{h'})] + \left\langle \begin{bmatrix} s^h \\ s^{h'} \end{bmatrix}, \delta \begin{bmatrix} s^h \\ s^{h'} \end{bmatrix} \right\rangle &= \left( L_d, \delta \begin{bmatrix} s^h \\ s^{h'} \end{bmatrix} \right) \\ \forall \delta s^h \in \mathbf{S}_{ad,0}^h \quad \forall \delta s^{h'} \in \mathbf{S}_{ad,0}^{h'}. & \end{aligned} \quad (10)$$

The second characteristic feature of the variational theory of complex rays is the use of two-scale approximations with strong mechanical content by differentiating three zones: the interior zone, the edge zone (Bolotin, 1960) and the corner zone. For example, in the vicinity of a point  $\underline{X}$  in the interior zone, the solution is assumed to be well-described locally as the superposition of an infinite number of local vibration modes, which can be written in the following manner:

$$\begin{aligned} \underline{U}(\underline{X}, \underline{Y}, \underline{P}) &= \underline{W}(\underline{X}, \underline{Y}, \underline{P}) \cdot \exp(i\omega \underline{P} \cdot \underline{Y}) \\ \sigma(\underline{X}, \underline{Y}, \underline{P}) &= \underline{C}(\underline{X}, \underline{Y}, \underline{P}) \cdot \exp(i\omega \underline{P} \cdot \underline{Y}), \end{aligned} \quad (11)$$

where  $\underline{X}$  represents the “slow” variable and  $\underline{Y}$  the “fast” one.  $\underline{P}$  is a vector characterizing the local vibration mode. These modes satisfy the law of dynamics in an infinite medium. They are defined explicitly in terms of the fast variable and, therefore, the unknowns are only large wavelength quantities. The definitions of corner and edge modes are very similar.

*Complex rays of  $n$ th order for the interior zone*

Given a homogeneous substructure, let us consider, for simplicity’s sake, the case where there is no force density ( $f_d = 0$ ). The first characteristic of the  $n$ th-order complex rays is that they can be considered as vibration modes in an infinite domain with the same mechanical properties as substructure S, i.e. they belong to  $\mathbf{S}_{ad}$ .

We have:

$$\begin{aligned} -k^2 \rho \omega^2 \underline{U} &= \text{div}(\underline{K} \mathfrak{f}(\underline{U})) \\ \sigma &= (1 + i\eta) \underline{K} \mathfrak{f}(\underline{U}) \\ k^2 &= \frac{1 - i\theta}{1 + i\eta}. \end{aligned} \quad (12)$$

The damping factors are assumed to be small. Thus,  $k$  can be written as follows:

$$k \approx (1 - i\frac{\delta}{2}) \quad \text{with } \delta = (\theta + \eta). \quad (13)$$

The second feature of  $n$ th-order complex rays is that they can be expressed as:

$$\begin{aligned} \underline{U}(\underline{X}, \underline{Y}, \underline{P}) &= \underline{W}(\underline{X}, \underline{P}) \cdot \exp(\omega \frac{\sigma}{2} \underline{P} \cdot \underline{X}) \cdot \exp(i\omega \underline{P} \cdot \underline{Y}) \\ \sigma(\underline{X}, \underline{Y}, \underline{P}) &= (1 + i\eta) \underline{K} \mathfrak{f}(\underline{U}). \end{aligned} \quad (14)$$

The generalized amplitude  $\underline{W}$  is an  $n$ th-order polynomial in  $\underline{X}$ .

*Remark.* The 0th-order complex ray can be considered as the first term of an asymptotic development where the small parameter is the factor  $\frac{1}{\omega}$ . This is a well-known concept in geometric optics (Bouche and Molinet, 1994; Ohayon, 1989).



Here, the method is revisited in order to build an exact solution in an infinite domain.

*0th-order complex rays*

In this case, the modes can be written as:

$$\begin{aligned}\underline{U}(\underline{X}, \underline{Y}, \underline{P}) &= \underline{W}(\underline{P}) \cdot \exp\left(\omega \frac{\delta}{2} \underline{P} \cdot \underline{X}\right) \cdot \exp(i\omega \underline{P} \cdot \underline{Y}) \\ \sigma(\underline{X}, \underline{Y}, \underline{P}) &= (1 + i\eta) \mathbf{K}_{\mathfrak{f}}(\underline{U}).\end{aligned}\quad (15)$$

From equation (12),  $(\underline{U}, \sigma) \in S_{ad}$  if and only if:

$$\underline{W} = \frac{1}{\rho} \mathbf{K}[\underline{W} \cdot \underline{P}^t]_{\text{sym}} \cdot \underline{P}.\quad (16)$$

By introducing:

$$\mathbf{A} \bullet = \frac{1}{\rho} \mathbf{K}[\bullet \underline{u}^t]_{\text{sym}} \cdot \underline{u} \quad \text{with} \quad \underline{u} = \frac{\underline{P}}{|\underline{P}|},\quad (17)$$

the previous problem for a single given direction  $\underline{u}$  can be rewritten as an eigenvalue problem: find  $(p, \underline{W})$  with  $\underline{W} \neq 0$  such that:

$$\underline{W} = p^2 \mathbf{A} \underline{W}.\quad (18)$$

$\mathbf{A}$  is a positive definite operator, such as Hooke's tensor  $\mathbf{K}$ .

Thus, the classical spectral theory can be applied. For each direction  $\underline{u}$ , we can find two couples  $(p_1, \underline{W}_1)$  and  $(p_2, \underline{W}_2)$  solutions of (16), with:

$$p_2 \geq p_1 > 0 \quad |\underline{W}_1| = |\underline{W}_2| = 1 \quad \underline{W}_1 \cdot \underline{W}_2 = 0,\quad (19)$$

where  $\underline{P}$  belongs to one of the two curves  $C_1$  or  $C_2$ , depending on the material properties:

$$C_1 = \{\underline{P} \text{ such as } \underline{P} = p_1 \underline{u}\} \quad C_2 = \{\underline{P} \text{ such as } \underline{P} = p_2 \underline{u}\}.\quad (20)$$

*Example.* For an isotropic material, Hooke's operator can be written as:

$$\mathbf{K}_{\mathfrak{f}} = \gamma \text{Tr}[\mathfrak{f}] \mathbf{1} + 2\mu \mathfrak{f}.\quad (21)$$

In this case,  $C_1$  and  $C_2$  (Figure 2) are two circles and their respective radii are  $\left[\frac{\rho}{2\mu+\gamma}\right]^{\frac{1}{2}}$  and  $\left[\frac{\rho}{\mu}\right]^{\frac{1}{2}}$ .

*nth-order complex rays*

The modes must satisfy the law of dynamics; therefore, each mode must satisfy the following equation:

$$-k^2 \rho \omega^2 \underline{W} = -k^2 \omega^2 \mathbf{K}[\underline{W} \cdot \underline{P}^t]_{\text{sym}} \cdot \underline{P} + ik\omega (\underline{\text{div}} \mathbf{K}[\underline{W} \cdot \underline{P}^t]_{\text{sym}} + \mathbf{K} \mathfrak{f}(\underline{W}) \cdot \underline{P}) + \underline{\text{div}} \mathbf{K} \mathfrak{f}(\underline{W}), \quad (22)$$

or:

$$\underline{W} - \frac{\mathbf{A} \underline{W}}{p^2} = -\frac{i}{\rho k \omega} \underline{\text{div}} \mathbf{K}[\underline{W} \cdot \underline{P}^t]_{\text{sym}} + [\mathbf{K} \mathfrak{f}(\underline{W}) \underline{P} - \frac{1}{\rho k^2 \omega^2} \underline{\text{div}} \mathbf{K} \mathfrak{f}(\underline{W})]. \quad (23)$$

If  $\underline{W}$  is a  $n$ th-order complex ray, the left-hand side of the previous relation is an  $n$ th-order expression also. The two elements on the right-hand side of the equation are, therefore, of order  $(n-1)$  and  $(n-2)$  respectively. Thus, it is easy to build a general approach in order to describe the  $n$ th-order complex rays. On the first order, the complex ray can be written as:

$$\underline{W}(\underline{X}, \underline{P}) = \underline{W}^0(\underline{P}) + \underline{W}^1(\underline{X}, \underline{P}), \quad (24)$$

where  $\underline{W}^0$  is a constant and  $\underline{W}^1$  is linear with respect to  $\underline{X}$ . Since  $\underline{W}$  must satisfy equation (23), we have:

$$\begin{aligned} \underline{W}^1 - \frac{\mathbf{A} \underline{W}^1}{p^2} &= 0 \\ \underline{W}^0 - \frac{\mathbf{A} \underline{W}^0}{p^2} &= -\frac{i}{\rho k \omega} \underline{\text{div}} \mathbf{K}[\underline{W}^1 \cdot \underline{P}^t]_{\text{sym}} + [\mathbf{K} \mathfrak{f}(\underline{W}^1) \underline{P}] + 0. \end{aligned} \quad (25)$$

From the first equation, we can get:

$$\underline{W}^1 = a^1 \underline{W}_1 + a^2 \underline{W}_2, \quad (26)$$

where  $\underline{W}^1$  and  $\underline{W}^2$  are the eigenvectors of  $\mathbf{A}$  relative to direction  $\underline{u}$ . We will describe only the construction of  $a^1$ , since the construction of  $a^2$  is similar. To the direction  $\underline{u}$  is associated the solution  $(p_1, \underline{W}_1)$  of equation (18). Since we have:

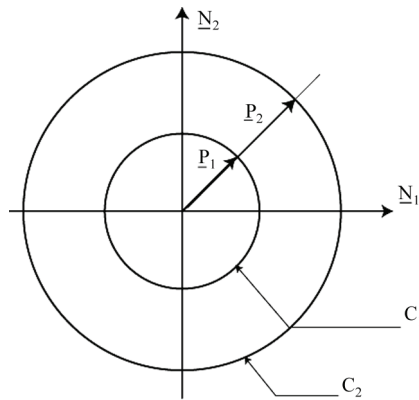

**Figure 2.**  
Set of wave vectors for  
the interior zone

$$a^1 = (\underline{\Gamma}^1)^t \underline{X} \quad \text{where } \underline{\Gamma}^1 \text{ is a constant vector,} \quad (27)$$

then:

$$\underline{W}^0 - \frac{\mathbf{A} \underline{W}^0}{p_1^2} = -\frac{i}{\rho k \omega} \left[ \mathbf{K} [\underline{\Gamma}^1 \cdot \underline{W}_1^t]_{\text{sym}} \underline{P} + \mathbf{K} [\underline{W}_1 \cdot \underline{P}^t]_{\text{sym}} \underline{\Gamma}^1 \right]. \quad (28)$$

Equation (28) has  $\underline{W}^0$  for a variable.  $\mathbf{A}$  is a symmetric, definite operator; therefore, equation (28) has a solution if and only if the second member of the equation is orthogonal to the kernel of the operator:

$$\left[ \mathbf{1} - \frac{\mathbf{A}}{p_1^2} \right], \quad (29)$$

which is defined by:

$$\{ \lambda \underline{W}_1 | \lambda \in \mathbb{R} \}. \quad (30)$$

Thus, we have the condition:

$$\underline{W}_1^t \cdot \left[ \mathbf{K} [\underline{\Gamma}^1 \cdot \underline{W}_1^t]_{\text{sym}} \underline{P} + \mathbf{K} [\underline{W}_1 \cdot \underline{P}^t]_{\text{sym}} \underline{\Gamma}^1 \right] = \mathbf{0}, \quad (31)$$

which can be written as:

$$\underline{\Gamma}^1 \cdot \left[ \mathbf{K} [\underline{W}_1 \cdot \underline{P}^t]_{\text{sym}} \underline{W}_1 \right] = 0. \quad (32)$$

Therefore:

$$\underline{\Gamma}^1 = \gamma^1 \underline{N}_3 \wedge \left[ \mathbf{K} [\underline{W}_1 \cdot \underline{P}^t]_{\text{sym}} \underline{W}_1 \right]. \quad (33)$$

Then, for  $p_2 \neq p_1$ , we have:

$$\underline{W}^0 = q^1 \underline{W}_1 + q^2 \underline{W}_2, \quad (34)$$

where  $q^1$  is arbitrary and

$$q^2 \left( 1 - \frac{p_2^2}{p_1^2} \right) = -\frac{i}{\rho k \omega} \left[ \text{Tr} \left[ \mathbf{K} [\underline{\Gamma}^1 \cdot \underline{W}_1^t]_{\text{sym}} [\underline{P}^t \cdot \underline{W}_2^t]_{\text{sym}} \right] + \text{Tr} \left[ \mathbf{K} [\underline{\Gamma}^1 \cdot \underline{W}_2^t]_{\text{sym}} [\underline{P}^t \cdot \underline{W}_1^t]_{\text{sym}} \right] \right]. \quad (35)$$

In summary, first-order complex rays contain 0th-order complex rays. In the case  $p_2 > p_1$ , they also depend on two constants  $\gamma^1$  and  $\gamma^2$ .

*Edge and corner complex rays*

In order to simplify the presentation, we will describe only the 0th-order edge and corner complex rays. Figure 3 shows the domain (the material is hatched).

The first characteristic of an edge complex ray is that it is admissible in a semi-infinite environment and, thus, it satisfies equation (12). The second characteristic of edge rays is the way they are represented:

$$\begin{aligned}\underline{U}(\underline{X}, \underline{Y}, \underline{P}) &= \underline{W}(\underline{X}, \underline{P}) \cdot \exp\left(\omega \frac{\delta}{2} \underline{P} \cdot \underline{X}\right) \cdot \exp(\omega p_1 X_1) \cdot \exp(i\omega p_2 X_2) \\ \sigma(\underline{X}, \underline{Y}, \underline{P}) &= (1 + i\eta) \mathbf{K} \mathfrak{f}(\underline{U}) \\ \underline{P} &= -ip_1 \underline{N}_1 + p_2 \underline{N}_2,\end{aligned}\quad (36)$$

where  $\underline{W}(\underline{X}, \underline{P})$  is a polynomial in terms of the slow variable  $\underline{X}$  (here  $X_2$ ) and  $p_1 > 0$ .

The 0th-order edge complex rays can be defined by:

$$\underline{W} = \frac{1}{\rho} [\mathbf{K}[\underline{W} \cdot \underline{P}^t]_{\text{sym}} \underline{P}]. \quad (37)$$

This equation can be written in the same form as in (18). Considering the case of an isotropic material:

$$\underline{W} \frac{1}{\rho} \gamma [\underline{P}^t \cdot \underline{W}] \underline{P} + \frac{2\mu}{\rho} [\underline{W} \cdot \underline{P}^t]_{\text{sym}} \underline{P}, \quad (38)$$

so that:

$$\underline{W} = \frac{\underline{P}}{\rho} [\gamma + \mu] \underline{P}^t \cdot \underline{W} + \frac{\underline{W}}{\rho} [\underline{P}^t \cdot \underline{P}] \mu, \quad (39)$$

thus:

$$\underline{W} \left(1 - \frac{\mu}{\rho} \underline{P}^t \cdot \underline{P}\right) = \underline{P}^t \cdot \underline{W} \left(\frac{\gamma + \mu}{\rho}\right) \underline{P}. \quad (40)$$

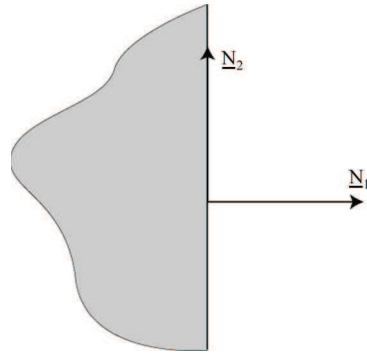

**Figure 3.**  
Edge vibration analysis

The solutions to this equation are:

$$\begin{aligned} \text{First case:} \quad \underline{P}^t \cdot \underline{P} &= -p_1^2 + p_2^2 = \frac{\rho}{\mu} & p_1 > 0 \\ \underline{W} &= w[\underline{N}_1 p_2 + i \underline{N}_2 p_1], \end{aligned} \quad (41)$$

where  $w$  is a parameter.

$$\begin{aligned} \text{Second case:} \quad \underline{P}^t \cdot \underline{P} &= -p_1^2 + p_2^2 \neq \frac{\rho}{\mu} \\ \underline{W} &= w \underline{P}. \end{aligned} \quad (42)$$

From equation (40), we can get:

$$1 - \left( \frac{2\mu + \gamma}{\rho} \right) \underline{P}^t \cdot \underline{P} = 0, \quad (43)$$

then:

$$-p_1^2 + p_2^2 = \frac{\rho}{2\mu + \gamma} \quad p_1 > 0. \quad (44)$$

The admissible values of  $(p_1, p_2)$  are given on Figure 4. We will not take these edge modes into account because they oscillate more than interior modes. In other terms, we consider that there are no edge modes.

Let us now consider the corner zone represented on Figure 5. The vibration mode is localized in the corner zone; therefore, it can be expressed as:

$$\{i \underline{P} \cdot \underline{X} = \alpha(\underline{n}_1 \cdot \underline{X}) + \beta(\underline{n}_2 \cdot \underline{X}), \quad (45)$$

with  $\text{Re}[\alpha] > 0$  and  $\text{Re}[\beta] > 0$ . If, eventually, we are interested in only the realistic modes, it is easy to prove that there can be no such modes in this case. In plate applications, however, things are different: there are edge and corner modes. Therefore, in the rest of this presentation, we will consider all the possible modes.

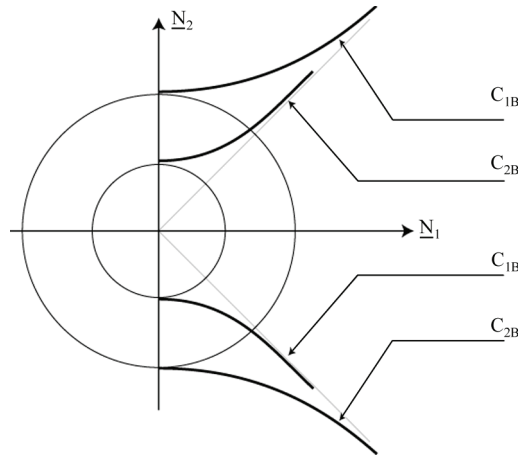

**Figure 4.**  
 $(p_1, p_2)$  admissible field  
for the edge zone

*Subspace*  $\mathbf{S}_{\text{ad}}^h$

Let us consider approximations by complex rays for the interior zone and the edge zone when they exist. For the interior zone, the  $n$ th-order complex rays constitute two families if:

$$\underline{P} \in C_1$$

$$\underline{U}^1(\underline{X}, \underline{Y}, \underline{P}) = \mathbf{W}(\underline{X}, \underline{P})[a^1(\underline{P})] \cdot \exp\left(\omega \frac{\delta}{2} \underline{P} \cdot \underline{X}\right) \cdot \exp(i\omega \underline{P} \cdot \underline{Y})$$

$$\phi^1(\underline{X}, \underline{Y}, \underline{P}) = (1 + i\eta) \mathbf{K}_{\mathfrak{F}}(\underline{U}^1) \quad (46)$$

$$\underline{P} \in C_2$$

$$\underline{U}^2(\underline{X}, \underline{Y}, \underline{P}) = \mathbf{W}(\underline{X}, \underline{P})[a^2(\underline{P})] \cdot \exp\left(\omega \frac{\delta}{2} \underline{P} \cdot \underline{X}\right) \cdot \exp(i\omega \underline{P} \cdot \underline{Y})$$

$$\phi^2(\underline{X}, \underline{Y}, \underline{P}) = (1 + i\eta) \mathbf{K}_{\mathfrak{F}}(\underline{U}^2).$$

For the interior zone, we take into account all admissible directions for the rays. The solution is thus:

$$\underline{U}^I(\underline{X}, \underline{Y}) = \int_{C_1} \underline{U}^1(\underline{X}, \underline{Y}, \underline{P}) ds_P + \int_{C_2} \underline{U}^2(\underline{X}, \underline{Y}, \underline{P}) ds_P \quad (47)$$

$$\phi^I(\underline{X}, \underline{Y}) = (1 + i\eta) \mathbf{K}_{\mathfrak{F}}(\underline{U}^I).$$

The integrals are calculated along curves  $C_1$  and  $C_2$ . It is clear that  $\underline{U}^I$  depends on the generalized amplitudes  $a_1$  and  $a_2$ , which are relative to  $\underline{P}$  defined on  $C_1$  and  $C_2$  respectively.

$$\begin{array}{l} \underline{a}_1 : \quad \underline{P} \longrightarrow \underline{a}_1(\underline{P}) \\ \quad \quad C_1 \longrightarrow C^m \end{array} \quad \begin{array}{l} \underline{a}_2 : \quad \underline{P} \longrightarrow \underline{a}_2(\underline{P}) \\ \quad \quad C_2 \longrightarrow C^m. \end{array} \quad (48)$$

The two curves  $C_1$  and  $C_2$  are discretized using finite elements. For example, the amplitudes  $\underline{a}_1$  and  $\underline{a}_2$  are assumed to be constant within each element. In this case, we have:

$$\begin{array}{ll} \underline{a}_1(\underline{P}) = \mathbf{H}^1(\underline{P}) \underline{a}_1^h & \text{for } \underline{P} \in C_1 \\ \underline{a}_2(\underline{P}) = \mathbf{H}^2(\underline{P}) \underline{a}_2^h & \text{for } \underline{P} \in C_2, \end{array} \quad (49)$$

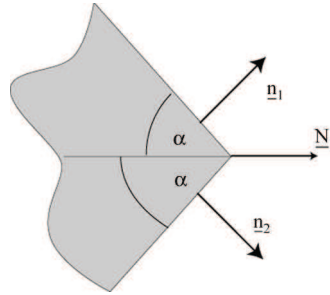

**Figure 5.**  
Corner vibration  
analysis

where  $\underline{a}^{I,h}$  is the column of generalized amplitudes:

$$\underline{a}^{I,h} = \begin{bmatrix} \underline{a}_1^h \\ \underline{a}_2^h \end{bmatrix}, \quad (50)$$

associated with the finite element discretization. Then, the approximation resulting from this discretization can be defined by equations (47) and (49). We have:

$$\begin{aligned} \underline{U}^{I,h}(\underline{X}, \underline{Y}) &= \mathbf{W}^{I,h}[\underline{a}^{I,h}] \\ \boldsymbol{\sigma}^{I,h}(\underline{X}, \underline{Y}) &= \mathbf{C}^{I,h}[\underline{a}^{I,h}], \end{aligned} \quad (51)$$

where  $\mathbf{W}^{I,h}$  and  $\mathbf{C}^{I,h}$  are two operators dependent on  $\underline{X}$  and  $\underline{Y}$ . The generalized amplitude  $\underline{a}^{I,h}$  belongs to  $C^m$ .

The same procedure can be applied to the corner or the edge zone:

$$\begin{aligned} \underline{U}^{B,h}(\underline{X}, \underline{Y}) &= \mathbf{W}^{B,h}[\underline{a}^{B,h}] \\ \boldsymbol{\sigma}^{B,h}(\underline{X}, \underline{Y}) &= \mathbf{C}^{B,h}[\underline{a}^{B,h}]. \end{aligned} \quad (52)$$

Finally, by summing up all contributions from the interior zone, the edge zone and the corner zone, we get:

$$\begin{aligned} \underline{U}^h(\underline{X}, \underline{Y}) &= \mathbf{W}^h[\underline{a}^h] \\ \boldsymbol{\sigma}^h(\underline{X}, \underline{Y}) &= \mathbf{C}^h[\underline{a}^h], \end{aligned} \quad (53)$$

where  $\mathbf{W}^h$  and  $\mathbf{C}^h$  are two operators dependent on  $\underline{X}$ ,  $\underline{Y}$ . The subspace  $\mathbf{S}_{ad}^h$  is then defined by:

$$\mathbf{S}_{ad}^h = \left\{ (\underline{U}^h, \boldsymbol{\sigma}^h) \mid \underline{U}^h = \mathbf{W}^h[\underline{a}^h]; \boldsymbol{\sigma}^h = \mathbf{C}^h[\underline{a}^h]; \underline{a}^h \in C^m \right\}. \quad (54)$$

#### *Discretized problem for a fixed frequency*

Given the assembly of two substructures  $S$  and  $S'$ , the variational theory which we just described leads to a linear system of equations in the complex domain:

$$[\mathbf{B}^h + \mathbf{Z}^h] \begin{bmatrix} \underline{a}^h \\ \underline{a}^h \end{bmatrix} = \underline{L}_d^h. \quad (55)$$

$\mathbf{B}^h$  is the damping matrix – a real, symmetric, positive definite operator. The operator  $\mathbf{Z}^h$  is associated with the bilinear form  $\langle \bullet, \bullet \rangle$ . It is defined such that:

$$(\mathbf{Z}^h)^{t*} = -\mathbf{Z}^h. \quad (56)$$

As a result of these last properties, equation (55) always has a unique solution.

*Remark.* Two cases can be identified. Either the excitation is at a fixed frequency  $\omega$ , or it spans an interval  $\Delta\omega$ . An *ad hoc* technique was developed for the latter case and will be presented in a subsequent paper.

### Generalized amplitudes

In order to solve the medium-frequency problem, it is necessary to extract from the solution the generalized amplitudes. The spatial distribution of the solution has no “physical meaning” from the mechanical point of view. This is the third feature (P3) which characterizes the variational theory of complex rays.

Given a substructure  $S$ , the quantities involved can be expressed as  $q(\underline{X}, \underline{Y})$ . In this case, the effective quantity is defined by:

$$\tilde{q}(\underline{X}) = \frac{1}{4L^2} \int_{-L-X_1}^{L-X_1} dY_1 \int_{-L+X_2}^{L+X_2} dY_2 q(\underline{X}, \underline{Y}). \quad (57)$$

$L$  is the characteristic dimension of the domain  $S$ . It is also possible to define effective quantities on the edge of  $S$ . Among the possible quantities, we can choose the elastic energy, the kinetic energy, the vibratory intensity or the dissipation. These quantities can also be defined for an interval  $\Delta\omega$ .

### Application to the calculation of medium-frequency plates assembly

#### Classical formulation

We consider only the assembly of two isotropic homogeneous plates with  $\Sigma$  and  $\Sigma'$  as reference surfaces. For each plate, we take into account the normal displacement  $w$  and the moment operator  $\mathbf{M}$ . Figure 6 describes the problem. The plate theory used here is Kirchhoff-Love's.

In order to simplify the presentation, the damping factors  $\theta$  and  $\theta'$  are ignored.

The subspace  $\mathbf{S}_{ad}$  is then defined by:

$$\mathbf{S}_{ad} = \left\{ (\underline{U}, \mathbf{M}) \in \mathbf{W} \otimes \mathbf{S} / (\underline{U}, \mathbf{M}) \text{ satisfy (59) and (60)} \right\}, \quad (58)$$

$$\Delta\Delta w \frac{2(1+i\eta)E_0 h^3}{3(1-\nu^2)} = 2\rho h\omega^2 w \quad \text{on } \Sigma, \quad (59)$$

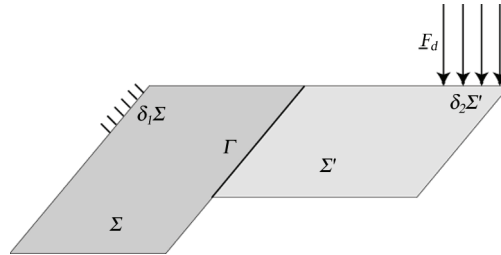

**Figure 6.**  
Reference problem



$$\mathbf{M} = \frac{2h^3}{3}(1 + i\eta)\mathbf{K}_{CP} \mathbf{X}(w) \quad \text{on } \Sigma. \quad (60)$$

$\mathbf{S}'_{ad}$  is defined in the same way.

Thus, the problem to be solved can be written as:

Find  $(w, \mathbf{M}) \in \mathbf{S}_{ad}$  and  $(w', \mathbf{M}') \in \mathbf{S}'_{ad}$  which satisfy the boundary conditions:

$$\begin{aligned} w &= w_d && \text{on } \partial_{wd}\Sigma \\ w_{,n} &= w_{nd} && \text{on } \partial_{wnd}\Sigma \\ -\underline{n} \mathbf{M} \underline{n} &= \mathbf{M}_d && \text{on } \partial_{Md}\Sigma \\ -(\underline{n} \underline{\text{div}}[\mathbf{M}] + (t \mathbf{M} \underline{n})_{,t}) &= K_d && \text{on } \partial_{Kd}\Sigma \\ [[t \mathbf{M} \underline{n}]] &= 0 && \text{on the corner of } \partial\Sigma \\ w &= w' && \text{on } \Gamma \\ w_{,n} &= w'_{,n} && \text{on } \Gamma \\ \underline{n} \mathbf{M} \underline{n} &= \underline{n}' \mathbf{M}' \underline{n}' && \text{on } \Gamma \\ \underline{n} \underline{\text{div}}[\mathbf{M}] + (t \mathbf{M} \underline{n})_{,t} &= \underline{n}' \underline{\text{div}}[\mathbf{M}'] + (t' \mathbf{M}' \underline{n}')_{,t'} && \text{on } \Gamma. \end{aligned} \quad (61)$$

*Variational formulation*

Find  $(w, \mathbf{M}) \in \mathbf{S}_{ad}$  and  $(w', \mathbf{M}') \in \mathbf{S}'_{ad}$  such that:

$$\begin{aligned} \text{Re} \left\{ & -i\omega \left( \int_{\partial_{wnd}\Sigma} \delta \underline{n} \mathbf{M} \underline{n} (w_{,n} - w_{nd})^* dL - \int_{\partial_{wd}\Sigma} \delta K_n (w - w_d)^* dL \right. \right. \\ & + \int_{\partial_{Md}\Sigma} (\underline{n} \mathbf{M} \underline{n} - M_d) \delta w_{,n}^* dL - \int_{\partial_{Kd}\Sigma} (K_n - K_d) \delta w^* dL \\ & + \int_{\partial_{wnd}\Sigma'} \delta \underline{n}' \mathbf{M}' \underline{n}' (w'_{,n'} - w'_{nd})^* dL - \int_{\partial_{wd}\Sigma'} \delta K'_{n'} (w' - w'_d)^* dL \\ & + \int_{\partial_{Md}\Sigma'} (\underline{n}' \mathbf{M}' \underline{n}' - M'_d) \delta w'_{,n'}{}^* dL - \int_{\partial_{Kd}\Sigma'} (K'_{n'} - K'_d) \delta w'^* dL \\ & - \sum_{\partial\Sigma \text{ corner}} [[t \mathbf{M} \underline{n}]] \delta w^* - \sum_{\partial\Sigma' \text{ corner}} [[t' \mathbf{M}' \underline{n}']] \delta w'^* \\ & + \int_{\Gamma} \frac{1}{2} [\delta (\underline{n} \mathbf{M} \underline{n} + \underline{n}' \mathbf{M}' \underline{n}')] (w_{,n} + w'_{,n'})^* - \delta (K_n - K'_{n'}) (w - w')^*] dS \\ & \left. + \int_{\Gamma} \frac{1}{2} [\delta (\underline{n} \mathbf{M} \underline{n} - \underline{n}' \mathbf{M}' \underline{n}')] \delta (w_{,n} - w'_{,n'})^* - (K_n + K'_{n'}) \delta (w + w')^*] dS \right\} \\ & = 0. \end{aligned} \quad (62)$$

### *Approximations*

The numerical examples presented here use 0th-order complex rays. The way in which they are built is described previously.

For plate  $\Sigma$ , a complex ray

$$w(\underline{X}, \underline{Y}, \underline{P}) = V(\underline{X}, \underline{P}) \cdot \exp\left(\frac{\eta}{4} \sqrt{\omega} \underline{P} \cdot \underline{X}\right) \cdot \exp(i\sqrt{\omega} \underline{P} \cdot \underline{Y}), \quad (63)$$

is admissible if and only if:

$$\rho 2h \omega^2 w = \frac{2h^3}{3} \frac{E}{(1-\nu^2)} (1+i\eta) \Delta \Delta w \quad \text{on } \Sigma, \quad (64)$$

$$\text{Thus:} \quad (\underline{P} \cdot \underline{P})^2 = r^4 \quad \text{with } r^4 = \left( \frac{3\rho(1-\nu^2)}{h^2 E} \right), \quad (65)$$

and so, the admissible wave vector set for the interior zone is a circle of radius  $r$ . For the edge zone and the corner zone, see before.

### **Examples**

#### *Comparison with an analytical solution*

In the case of a rectangular plate simply supported on its edges (Figure 7), the eigenmodes are known analytically. The mechanical properties are given by:

$$E = 23\text{Gpa}; \eta = 0.001; \nu = 0.3; \rho = 250\text{kg/m}^3; \omega = 6,000\text{Hz}, F_d = 1\text{N}.$$

In order to be in the medium-frequency case, the number of eigenmodes must be greater than 1,000. In this case, we will use as reference the solution obtained with 1,600 eigenmodes.

As we can see on Figures 8 and 9, the results given by the VTCR are good even though the solution may differ slightly locally (64 degrees of freedom were used to solve the problem).

In order to compare the different solutions using an effective quantity, we considered the average displacement in the plate around 6,000Hz (Figure 10). The VTCR is able to predict the right level.

#### *Triangular plate*

In the case of a triangular plate, it is impossible to predict which wave directions are relevant. In this case, a continuous description of the amplitude circle allows us to take into account all wave directions, thus ensuring that none are forgotten (Figure 11).

The solution was obtained using 64 interior degrees of freedom, 11 edge degrees of freedom and one corner degree of freedom. The result is satisfactory, given that the boundary conditions are satisfied in an average sense (Figure 12).

3D plates assembly

The mechanical properties of 18 steel plates (Figure 13) are given by:

$$E = 210\text{Gpa}; \eta = 0.01; \nu = 0.3; \rho = 7,800\text{kg/m}^3; h = 0.0016\text{m}; \omega = 3,000\text{Hz};$$

$$F_d = 1\text{N}.$$

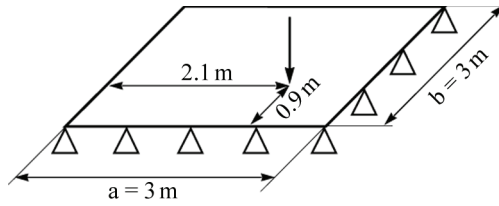

Figure 7.  
Configuration

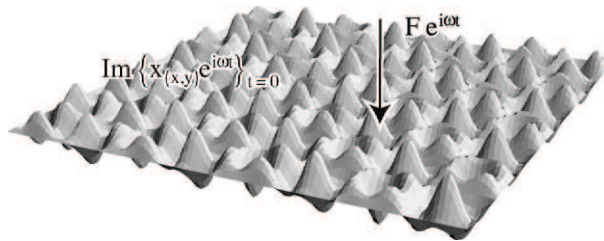

Figure 8.  
Analytical solution

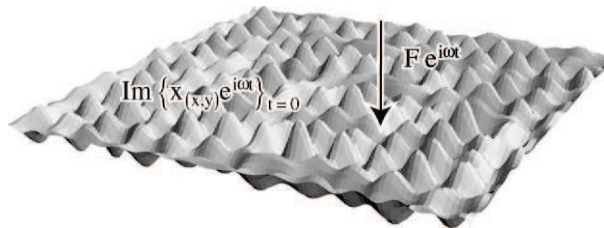

Figure 9.  
VTCR solution (64 d.o.f.)

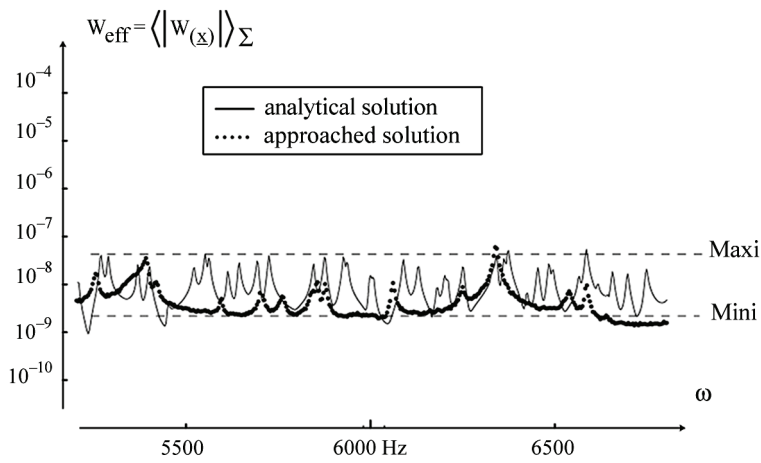

Figure 10.  
VTCR solution (64 d.o.f.)

The solution was obtained using 30 interior modes and six edge modes per plate. In this case, we had to solve a  $(5,328 \times 5,328)$  linear problem, since first-order complex rays were used.

The number of degrees of freedom is very small (296 per plate) given the frequency. The boundary conditions are satisfied in an average sense. In order to compare the VTCR solution (Figure 14) with experimental data, the effective displacements on patches can be post-processed (Figure 15). These effective quantities are not very sensitive and are physically more meaningful than classical quantities such as point displacements, which can be subject to large variations when any of the input data varies. The VTCR can easily calculate any number of homogeneous substructures with no special difficulty.

### Conclusion

The proposed approach called the “variational theory of complex rays” was introduced in order to calculate the vibrations of weakly damped elastic

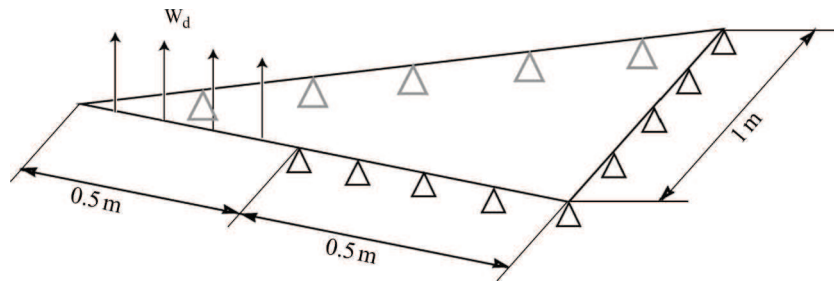

Figure 11.  
Configuration

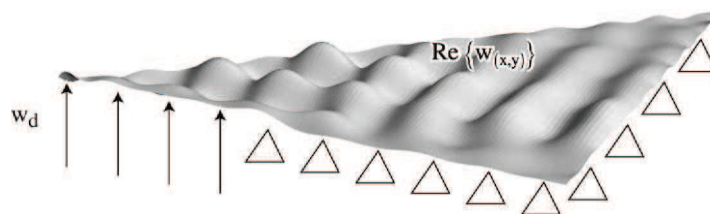

Figure 12.  
VTCR solution

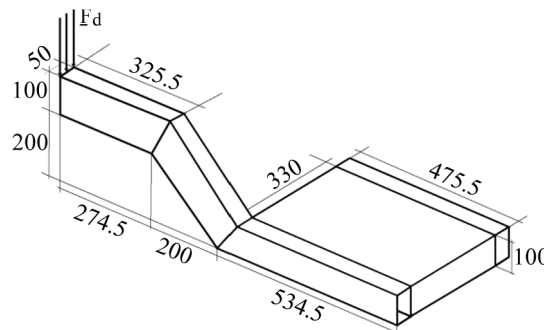
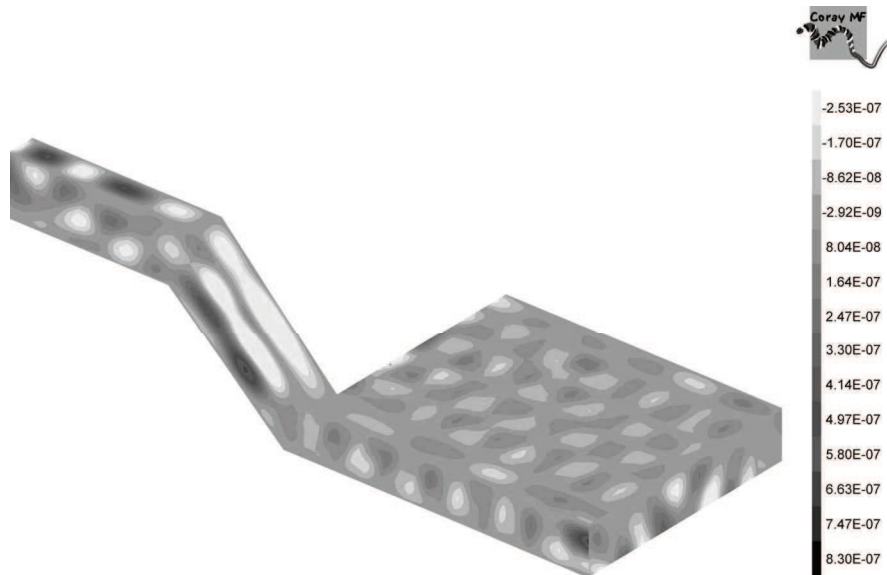
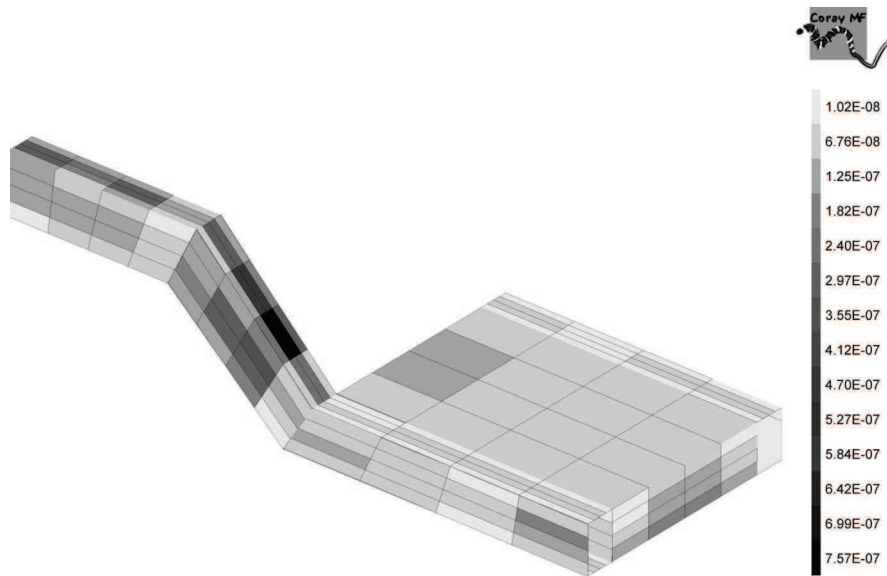

Figure 13.  
Configuration  
(measurements are in mm)



**Figure 14.**  
VTCR solution



**Figure 15.**  
Post-processing:  
effective displacements

structures in the medium-frequency range. It is a very general approach and it has a strong mechanical basis. In some cases, such as beam assemblies, it leads to the exact solution in tension as well as in bending. For complex structures, the VTCR seems to be a promising theory for medium-frequency applications. In the near future, other works will better outline its possibilities. In particular, an appropriate approach will be proposed to deal with wide-band frequency excitation.

## References

- Babuska, I., Ihlenburg, F., Paik, E. and Sauter, S. (1995), "A generalized finite element method for solving the Helmholtz equation in the two dimensions with minimal pollution", *Comput. Methods Appl. Mech. Engrg.*, Vol. 128, pp. 325-59.
- Barbone, P.E., Montgomery, J.M., Michael, O. and Harari, I. (1998), "Scattering by a hybrid asymptotic/finite element method", *Comput. Methods Appl. Mech. Engrg.*, Vol. 164, pp. 141-56.
- Belov, V.D. and Ryback, S.A. (1975), "Applicability of the transport equation in the one-dimensional wave propagation problem", *Akust. Zh., Sov. Phys. Acoust.*, Vol. 21 No. 2, pp. 173-80.
- Belov, V.D. and Ryback, S.A. (1977), "Propagation of vibrational energy in absorbing structures", *Sov. Phys. Acoust.*, Vol. 23 No. 2, pp. 115-19.
- Bolotin, V.V. (1960), "The edge effect in the oscillations of elastic shells", *PPM*, Vol. 24 No. 5, pp. 831-43.
- Bouche, D. and Molinet, F. (1994), "Méthodes asymptotiques en électromagnétisme", *Coll. Mathématiques et applications*, Springer.
- Bouillard, P. and Ihlenburg, F. (1998), "Error estimation and adaptativity for the finite element solution in acoustics", in Ladevèze, P. and Oden, J.I. (Eds), *Advances in Adaptive Computational Methods in Mechanics*, Elsevier, pp. 477-92.
- Bouthier, O.M. and Bernhard, R.J. (1995), "Simple models of the energetics transversely vibrating plates", *J. Sound Vib.*, Vol. 182 No. 1, pp. 149-66.
- Buvailo, L.E. and Ionov, A.V. (1980), "Application of the finite element method to the investigation of the vibroacoustical characteristics of structures at high audio frequencies", *Sov. Phys. Acoust.*, Vol. 26 No. 4, pp. 277-9.
- Cuschieri, J.M. (1990), "Vibration transmission through periodic structures using a mobility power flow approach", *J. Sound Vib.*, Vol. 143 No. 1, pp. 65-74.
- de Langre, E. (1991), "Fonctions de transfert de plaques en flexion par équations intégrales. Test de validation et de performance", Rapport CEA: DMT/90/395.
- Demkowicz, L., Karafiat, A. and Oden, J.I. (1992), "Solution of elastic scattering problems in linear acoustics using h-p boundary element method", *Comput. Methods Appl. Mech. Engrg.*, Vol. 101, pp. 251-82.
- Deraemaeker, A., Babuska, I. and Bouillard, P. (1999), "Dispersion and pollution of the FEM solution for the Helmholtz equation in one, two and three dimensions", *Int. J. Numer. Methods Engrg.*, Vol. 46, pp. 471-99.
- Dowell, E.H. and Kubota, Y. (1985), "Asymptotic modal analysis and statistical energy of dynamical systems", *J. Appl. Mech.*, Vol. 52, pp. 949-57.
- Girard, A. and Defosse, H. (1993), "Frequency response smoothing and structural path analysis: application to beam trusses", *J. Sound Vib.*, Vol. 165 No. 1, pp. 165-70.
- Greenstadt, J. (1999), "Solution of wave propagation problems by the cell discretisation method", *Comput. Methods Appl. Mech. Engrg.*, Vol. 174, pp. 1-21.
- Grosh, K. and Pinsky, P.M. (1998), "Galerkin generalized least square finite element methods for time harmonic structural acoustics", *Comput. Methods Appl. Mech. Engrg.*, Vol. 154, pp. 299-318.
- Harari, I. and Haham, S. (1998), "Improved finite element method for elastic waves", *Comput. Methods Appl. Mech. Engrg.*, Vol. 166, pp. 143-64.
- Harari, I. and Huges, J.R. (1992), "Galerkin least-squares finite element method for the reduced wave equation with non reflecting boundary condition in unbounded domains", *Comput. Methods Appl. Mech. Engrg.*, pp. 411-54.

- Harari, I., Gresh, K., Huges, J.R., Malkostra, M., Pinsky, M., Steward, J.R. and Thompson, L. (1996), "Recent developments in finite element methods for structural acoustics", *Arch. of Comput. Meth. Eng.*, Vol. 3, pp. 131-311.
- Hochard, C., Ladevèze, P. and Proslie, L. (1993), "A simplified analysis of elastic structures", *Eur. J. Mech. A/Solids*, Vol. 12 No. 4, pp. 509-35.
- Ichchou, M.N., Le Bot, A., Jézéquel, L. (1997), "Energy model of one-dimensional, multipropagative systems", *J. Sound Vib.*, Vol. 201 No. 5, pp. 535-54.
- Ihlenburg, F. and Babuska, I. (1995), "Dispersion analysis and error estimation of Galerkin finite element methods for Helmholtz equation", *Int. J. Num. Methods Engrg.*, Vol. 38, pp. 3745-74.
- Ihlenburg, F. and Babuska, I. (1997), "Finite element solution of the Helmholtz equation with high wave number Part 2: the h-p version of the FEM", *SIAM J. Numer. Anal.*, Vol. 34 No. 1, pp. 315-58.
- Ladevèze, P. (1981), "RDM tridimensionnelle", Rapport Interne No. 12, LMT Cachan .
- Ladevèze, P. (1995), "Prédiction des vibrations moyennes fréquences: Etat de l'art et remarques", NT Aérospatiale YX/SA 116 471.
- Ladevèze, P. (1996a), "Une nouvelle approche pour le calcul des vibrations moyennes fréquences", NT Aérospatiale YX/SA 119 639.
- Ladevèze, P. (1996b), "A new computational approach for structure vibrations in the medium frequency range", *C. R. Acad. Sci., Paris*, t.322, Série II b, No. 12 pp. 849-56.
- Langley, R.S. (1995), "On the vibrational conductivity approach to high frequency dynamics for two-dimensional structural components", *J. Sound Vib.*, Vol. 182 No. 4, pp. 637-57.
- Lase, Y., Ichchou, M.N. and Jézéquel, L. (1994), "Energy flow analysis of bars and beams: theoretical formulation", *J. Sound Vib.*, Vol. 192 No. 1, pp. 2981-3005.
- Leung, A.Y.T. and Chan, J.K.W. (1998), "Fourier p-element for the analysis of beams and plates", *J. Sound Vib.*, Vol. 212 No. 1, pp. 179-95.
- Liu, W.K., Zhang, Y. and Ramirez, M.R. (1991), "Multiple scale finite element methods", *Int. J. Num. Methods Engrg.*, Vol. 32, pp. 969-90.
- Luzzato, E. (1989), "EDF workshop proceeding on methods in medium and high frequency: the alternative to SEA".
- Lyon, R.H. and Maidanik, G. (1962), "Power flow between linearly coupled oscillators", *JASA*, Vol. 34 No. 5, pp. 623-39.
- Lyon, R.H., Richard, H. and Richard, G. (1995), *Statistical Energy Analysis*, Butterworth-Heinemann.
- Mace, B.R. (1994), "On the statistical energy analysis hypothesis of coupling power proportionality and some implications of its failure", *J. Sound Vib.*, Vol. 178 No. 1, pp. 95-112.
- Morand, J.P.H. (1992), "A modal hybridization method for the reduction of dynamic models", in Ladevèze, P. and Zienkiewicz, O.C. (Eds), *New Advances Computational Structural Mechanics*, Elsevier, pp. 347-65.
- Nefske, D.J. and Sung, S.H. (1989), "Power flow finite element analysis of dynamic systems: basic theory and application of beams", *J. Vib. Acoust.*, Stress and Reliability in Design, ASME, Vol. 111, pp. 94-100.
- Ochmann, M. and Makarov, S.N. (1998), "An iterative solver of the Helmholtz integral equation for high frequency acoustic scattering", *JASA*, Vol. 103 No. 2, pp. 742-50.
- Ohayon, R. (1989), "Local and global effects in the vibration of structures. A review synthesis", in ESTEC, *ESA Workshop Proceeding on Modal Representation of Flexible Structures by Continuum Methods*, Noordwijk, Netherlands, pp. 29-54.

- Rizzo, F.J., Shippy, D.J. and Rezayat, M. (1985), "A boundary integral equation method for radiation and scattering of elastic waves in the three dimensions", *Int. J. Num. Methods Engrg.*, Vol. 21, pp. 115-29.
- Rosenhouse, G., Avrashi, J. and Michael, O. (1997), "Steady state elastodynamics using boundary spectral line strips", *Engrg Comput.*, Vol. 15 No. 2, pp. 221-32.
- Soize, C. (1985), "The local effects in the linear dynamic analysis of structures in the medium frequency range", in Ladevèze, P. (Eds), *Local Effects in the Analysis of Structures*, Elsevier, Barking and Amsterdam, pp. 253-78.
- Soize, C. (1998), "Reduced models in the medium-frequency range for general dissipative structural-dynamics systems", *European Journal of Mechanics, A/Solids*, Vol. 17 No. 4.
- Wiberg, N.E., Bausys, R. and Hager, P. (1996), "Improved eigen frequencies and eigenmodes in free vibration analysis", in Topping, B.H.V. (Ed.), *Advances in Finite Element Technology*, Civil Comp. Press, Saxe-Coburg pp. 43-54.
- Wu, K. and Ginsberg, J.H. (1998), "Mid frequency range acoustic radiation from slender elastic bodies using the surface variational principle", *J. Vib. Acoust.*, Vol. 120, pp. 392-400.
- Yoon Young, K. and Jeong Hoon, K. (1996), "Free vibration analysis of membrane using wave type base functions", *JASA*, Vol. 99 No. 5, pp. 2938-46.
- Zielinski, A.P. and Herrera, I. (1987), "Trefftz method: fitting boundary conditions", *Int. J. Num. Methods Engrg.*, Vol. 24, pp. 871-91.