



**HAL**  
open science

## Syngas production by plasma treatments of alcohols, bio-oils and wood

Khadija Arabi, Olivier Aubry, Ahmed Khacef, Jean Marie Cormier

► **To cite this version:**

Khadija Arabi, Olivier Aubry, Ahmed Khacef, Jean Marie Cormier. Syngas production by plasma treatments of alcohols, bio-oils and wood. *Journal of Physics: Conference Series*, 2012, 406, pp.8. 10.1088/1742-6596/406/1/012026 . hal-00848940

**HAL Id: hal-00848940**

**<https://hal.science/hal-00848940v1>**

Submitted on 29 Jul 2013

**HAL** is a multi-disciplinary open access archive for the deposit and dissemination of scientific research documents, whether they are published or not. The documents may come from teaching and research institutions in France or abroad, or from public or private research centers.

L'archive ouverte pluridisciplinaire **HAL**, est destinée au dépôt et à la diffusion de documents scientifiques de niveau recherche, publiés ou non, émanant des établissements d'enseignement et de recherche français ou étrangers, des laboratoires publics ou privés.

## Syngas production by plasma treatments of alcohols, bio-oils and wood

This article has been downloaded from IOPscience. Please scroll down to see the full text article.

2012 J. Phys.: Conf. Ser. 406 012026

(<http://iopscience.iop.org/1742-6596/406/1/012026>)

View [the table of contents for this issue](#), or go to the [journal homepage](#) for more

Download details:

IP Address: 193.49.77.129

The article was downloaded on 21/03/2013 at 07:39

Please note that [terms and conditions apply](#).

# Syngas production by plasma treatments of alcohols, bio-oils and wood

**K. Arabi, O. Aubry, A. Khacef, J-M Cormier**

GREMI, CNRS-Université d'Orléans, 14 Rue d'Issoudun, 45067 Orléans, France

E-mail: jean-marie.cormier@univ-orleans.fr

**Abstract.** Exploitation of forest resources for energy production includes various methods of biomass processing. Gasification is one of the ways to recover energy from biomass. The Syngas produced from biomass can be used to power internal combustion engines, or, after purification, to supply fuel cells. The paper is summarizing results obtained through a non thermal arc plasma reactor at laboratory scale. A stationary discharge ( $I = 150\text{mA}$ ) is used to perform physical diagnostics and also chemical analysis. The arc is formed between two electrodes made of graphite. We first present results on plasma-steam reforming of alcohols and bio-oils mixed in water. The outlet gas compositions are given from various alcohols and bio-oils obtained at different experimental conditions. The second part of the paper is dedicated to a direct plasma treatment of wood (beech) at laboratory scale. One of the electrodes is surrounded by wood. The final part of the paper is a general discussion about efficiencies and comparisons of plasma treatments presented. The results obtained are discussed by considering the steam reforming reactions and the water gas shift reaction.

## 1. Introduction

Biomass is considered as a renewable, storable and transportable energy source which is available in various forms such as wood, agricultural and forest residues.

Pyrolysis and Gasification are efficient ways for biomass utilization [1-4] and specially Syngas production. The thermochemical and biological conversion of biomass provide a great variety of products: oils, alcohols and gases. After treatment, these products can be used for various energy applications.

Reduction of greenhouse gas emission can be improved using syngas and hydrogen obtained from biomass. These requirements present a necessity to develop new types of method for the hydrogen production and Syngas production [4, 5].

Some authors have performed the possibility to use plasma reactor for hydrogen production from water and hydrocarbons, alcohol or biomass with high  $\text{H}_2$  yields with limited costs [6-9]. Steam reforming using non thermal plasma processes is studied many years ago [6,7].

This paper is devoted to a comparative study of Syngas ( $\text{H}_2+\text{CO}$ ) production from alcohol (methanol, ethanol, phenol) and others hydrogenated liquids and also wood.

## 2. Experimental techniques

The experimental plasma reactor used in this work was described previously [8]. Laboratory-scale experiments were carried out with a liquid mixture injected at atmospheric pressure into a non-thermal plasma reactor (Figure 1).

The discharge is called Non Thermal Arc (NTA) [9] although the voltage drop at the electrodes is significantly greater than voltage drop of conventional arcs.

The plasma reactor includes a quartz tube (400 mm length and 30 mm inner diameter) containing two electrodes made of graphite. The conical extremities of the two electrodes are placed opposite each other. The electrode gap is 10 mm. The discharge column looks like a plasma string with a diameter of 2 mm diameter and length of 10 mm.

Liquid mixtures are injected with a syringe pump, which permits to adjust the total liquid flow rate at the inlet of the reactor from about 0.5 to 2.1 sccm.

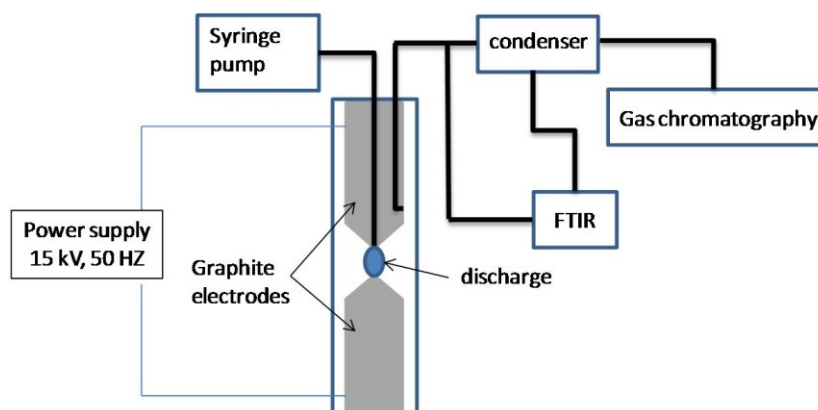

Figure 1. Experimental set up.

The inlet alcohol/water liquid mole ratios studied are from 0.07 to 0.19 and from 0.1 to 0.27 for the ethanol and methanol mixtures, respectively. The liquids are vaporized during their flow in the upper electrode before the discharge injection. Graphite electrodes are heated by plasma.

The gas discharge is powered by a 50 Hz high-voltage transformer with leakage flux (primary 230V, secondary 20kV,  $I_2 = 155$  mA). The current and voltage waveforms are measured using a current and a differential voltage probes respectively. The signals are recorded on a digital oscilloscope. From the current and voltage data, the power can be calculated and the energetic cost of production  $H_2$  can be estimated. Plots of voltage and current are given on figure 2. At a maximum of current (about 230 mA), a quasi constant voltage is observed (900V). Periodic high voltages peak are observed at the zero current transition of the alternating current.

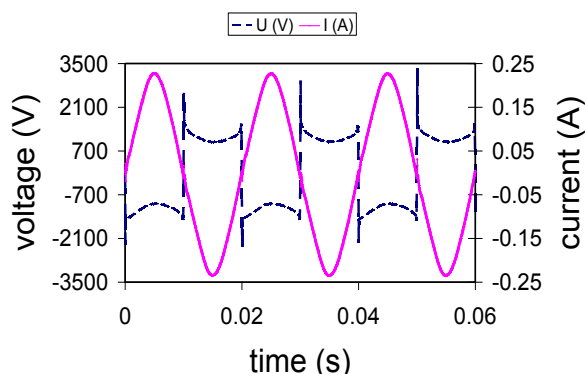

Figure 2. Variations of the voltage and current as a function of the time, inlet liquid volume ethanol/water ratio = 0.23.

At the outlet reactor, analyses are performed on exhaust gas to measure species concentrations in wet gas or in dry exhaust gas. For this latter, the outlet gas is condensed using a cryogenic trap ( $-20^{\circ}C$ ) and

analyzed using a gas phase chromatography analyzer (GC-Varian CP 3800). H<sub>2</sub>, CO, CO<sub>2</sub>, CH<sub>4</sub>, C<sub>2</sub>H<sub>2</sub>, C<sub>2</sub>H<sub>4</sub> and C<sub>2</sub>H<sub>6</sub> species can be easily quantified.

### 3. Plasma steam reforming of methanol and ethanol

#### 3.1 Effects of the total flow rate and inlet alcohol concentration

Figures 3 display the concentration of the main produced species as a function of the total flow rate. Two ethanol/water and methanol/water inlet liquid volume ratios are studied. Main species are H<sub>2</sub>, CO, CO<sub>2</sub> and CH<sub>4</sub>. C<sub>2</sub> species are also produced but their concentrations are remaining lower than 1.5%.

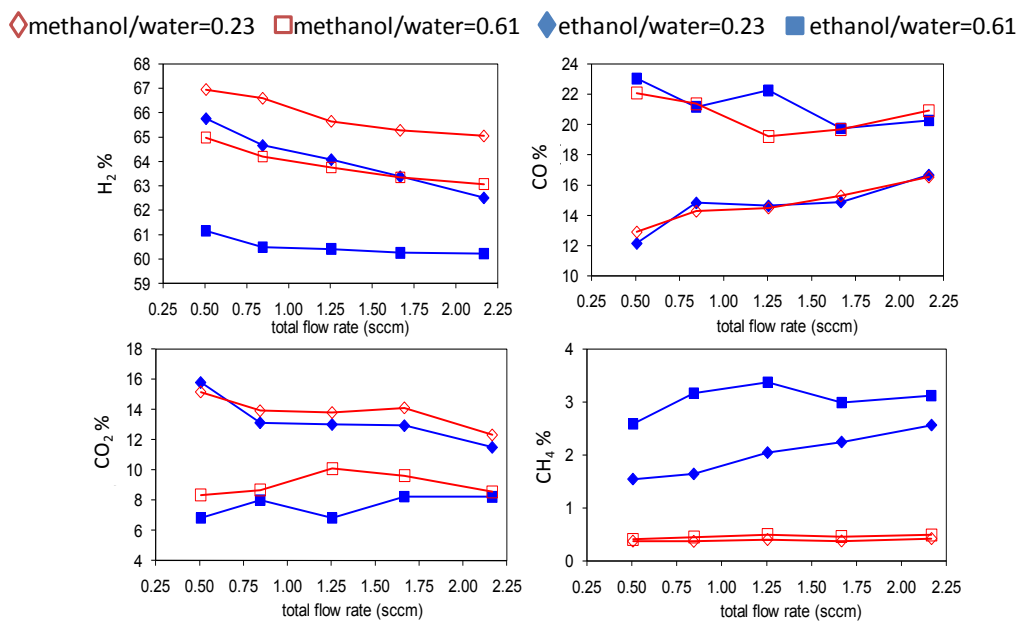

**Figure 3.** H<sub>2</sub>, CO, CO<sub>2</sub> and CH<sub>4</sub> concentrations vs. the inlet total flow rate. Open symbols: methanol+water mixtures; full symbols: ethanol+water mixtures. Alcohol/water volume ratios: square symbols: 0.23; diamond symbols: 0.61.

Increase of flow rate generates a decrease in hydrogen concentration probably due to the decrease of residence time in the reactor. A rise of the alcohol/water ratio leads to a decrease of H<sub>2</sub> production. The lowest CO concentrations corresponding to the highest CO<sub>2</sub> concentrations are observed for highest dilutions of alcohols in water. CH<sub>4</sub> is the main hydrocarbon produced; its maximum concentration is about 3% in the ethanol mixtures. CH<sub>4</sub> is promoted when alcohol/water ratios and/or the total flow rate increase. In the ethanol mixtures, hydrocarbon species seem to be produced more easily corresponding to an increase of the inlet carbon number. Similar results are obtained for C<sub>2</sub> species, which are not presented here because their concentrations remain low.

From these results it can be proposed the following reactions involved in the process for methanol and ethanol.

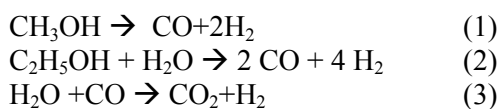

Main part of hydrogen is produced by cracking (1) or steam reforming (2) and the water gas shift (3) reaction( WGS) is acting simultaneously to produce CO<sub>2</sub> and hydrogen enrichment.

In this case, given the results, we can assume that the WGS reaction is more efficient in excess water. This may explain higher hydrogen concentrations at low concentrations of alcohols. A more detailed interpretation of these results, based on this model is underway.

### 3.2 Energy balance

From the results, losses energy in the reactor have been estimated. To evaluate the losses, vaporization energy (to vaporize inlet liquid mixtures) and reaction energy are take into account. Energy losses, E<sub>i</sub>, are calculated from the next expression:

$$E_i = E_t - E_r - E_{\text{evap}} \quad (4)$$

Where, E<sub>t</sub> is the total energy injected in the reactor. E<sub>t</sub> is calculated from injected power by integration of P over time. P is define in equation 5. It should be noted that the only external source of power is the electrical generator.

$$P = \frac{1}{T} \int_0^T u(t).i(t) dt \quad (5)$$

Er takes into account steam-reforming and water gas shift reactions energies, Evap is the consumed energy to vaporise the inlet liquid mixture. In table 1, we present the various energy for ethanol steam reforming.

X C <sub>2</sub> H <sub>5</sub> OH	Time (h)	E <sub>t</sub> (Wh)	Evap (Wh)	E <sub>r</sub> (Wh)	E <sub>i</sub> (Wh)
0.07	0.012	1.77	0.94	0.121	0.709
0.22	0.006	1.01	0.48	0.115	0.415
0.49	0.004	0.76	0.32	0.112	0.328

**Table 1.** Energies implied in the process.

One can observe that a rise of the inlet alcohol mole fraction leads to a decrease of the energy losses, because E<sub>t</sub> highly decreases in these mixtures. This decrease is due to a decrease of the conductance because of less water vapor is in the plasma. Same trends are observed for other alcohols treatments.

About half of the total energy injected in the reactor is lost. It is possible to reduce the energy costs by increasing the electrode gap. The efficiency of the process can be improved by increasing the length of the plasma column that reduce the relative power dissipated at the electrodes.

### 4. Comparison of results obtained from three alcohols: methanol, ethanol and phenol

To summarize the results obtained with different alcohols concentrations, main species are represented, according to the atomic ratios H/C and H/O of alcohol-water mixtures injected at the reactor. Inlet ratios are calculated from the inlet mixtures composition by considering that all the injected liquid is vaporized through upper electrode. Thus, liquid moles and vapor moles of ethanol and water are the same. An increase of the inlet alcohol concentration leads to a decrease of H/C and a rise of H/O values. . We report, figures 4, H<sub>2</sub>, CO and CO<sub>2</sub> mol% as functions of the inlet H/C and H/O ratios.

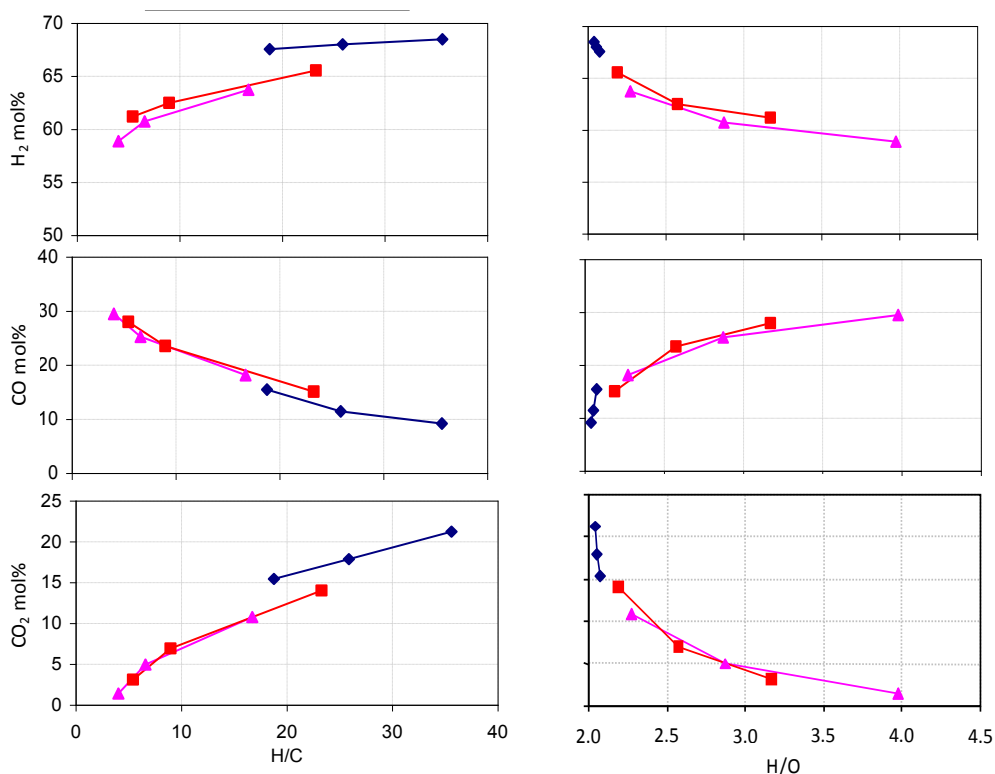

**Figure 4.** H<sub>2</sub>, CO, CO<sub>2</sub> mol% vs. inlet H/C and H/O ratios. ▲ methanol+H<sub>2</sub>O; ■ ethanol+H<sub>2</sub>O; ◆ phenol+H<sub>2</sub>O.

H<sub>2</sub> and CO<sub>2</sub> concentrations increase when H/C increases or H/O decreases. CO concentrations decrease for H/C increasing or H/O decreasing. Alcohol nature, at given H/C and H/O values, have not significant effects on the species concentrations. Changes in different concentrations depending on H/C and H/O can be approximately described by continuous functions independent of alcohols nature.

### 5. Experiments with other reactants

Experiments with others reactants have been also performed with ammonia and aBio- oil diluted or not in water. In Table 2, we report the inlet mixtures parameters and main dry gases produced and their concentrations.

**Table 2.** Produced species concentrations in dry gas from ammonia and Bio-oil mixtures.

Inlet mixtures	H/O	H/C	flow rate (sccm)	H <sub>2</sub> (%)	CO (%)	CO <sub>2</sub> (%)	CH <sub>4</sub> (%)
13% vol. NH <sub>3</sub> + H <sub>2</sub> O	2.45	-	1.25	55	0.6	-	-
Pure Bio oil	2.25	1.5	0.026	63.5	14.5	21.5	0.38
10% vol. Bio oil + H <sub>2</sub> O	2.1	28.3	0.026	59.6	27.7	17.1	0.4

This table shows that oils obtained from various process can be easily treated by plasma to produce Syngas. In comparison with classical gassification process, high values of H<sub>2</sub>/CO (>1) can be obtained.

Ammonia could be an interesting hydrogen source by reforming in-situ because NH<sub>3</sub> is easily transportable and storable. H<sub>2</sub> concentration obtained from the ammonia mixture is slightly lower than in alcohol ones for the same total flow rate and inlet H/O: about 64-66% in alcohols mixtures against 55% with NH<sub>3</sub>.

## 6. Direct plasma steam reforming of wood

### 6.1 The experimental system

The device is practically the same (Figure 5) as presented above excepted for the top electrode. This electrode is made of a very fine graphite rod surrounded by wood (beech).

The water is introduced through the lower electrode and is vaporized in plasma region. At start-up, the plasma column is developed only between the electrodes. Subsequently, due to the wood pyrolysis, the discharge can move on the surface of the carbon layer appeared on the wood. The figure 6 shows an example of the discharge obtained from wood treatment.

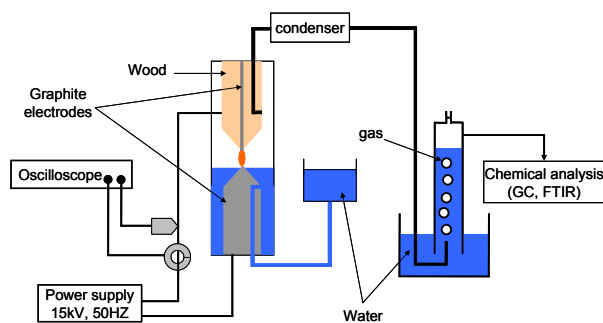

**Figure 5:** Schematic of experimental reactor

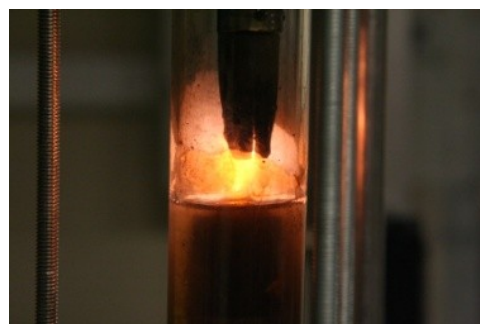

**Figure 6:** photography of the discharge between electrodes.

### 6.2 Results

The equation (4) of the biomass treatment (beech wood) is written as:

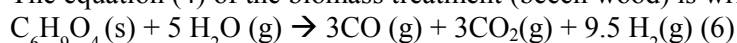

In table 3, the results obtained with biomass treatment are reported for two values of the electrodes gap ( $D_{int} = 1\text{cm}$  and  $D_{int} = 2.5\text{cm}$ ).

The observed species are mainly H<sub>2</sub>, CO, CO<sub>2</sub> and CH<sub>4</sub>. C<sub>2</sub> hydrocarbons species are less than 0.5 %

**Table 3 :** Species concentration in dry gas from wood and gas flow rate (L/h) as a function of electrodes gap

D int (cm)	Analysis GC dry gas				Produced gas flow rate (L/h)
	H <sub>2</sub>	CO <sub>2</sub>	CO	CH <sub>4</sub>	
1	57.8	17.9	22.5	1.2	5.6
2.5	58.3	19.3	19.7	2.3	13.6

The concentrations of the produced species are of the same order for the two distances between electrodes.

Moreover, the flow of gas production increases (from 5.6L/h to 13.6L/h) when the length of the plasma column increases.



The efficiency of plasma increases with the length of the plasma column.

Theoretically, the concentration of H<sub>2</sub>, CO and CO<sub>2</sub> are calculated from stoichiometric coefficient using reaction (4) for the biomass treatment. The following mixture composition of dry gas is found as:

$$\begin{aligned} \text{H}_2 &= 61\% \\ \text{CO} &= 19\% \\ \text{CO}_2 &= 19\% \end{aligned}$$

We observe that H<sub>2</sub>, CO and CO<sub>2</sub> concentrations are similar to those obtained from experiment.

Therefore, the reaction (4) of biomass treatment well describes the experimental results and it is the dominant process.

### 6.3 Energy interest of wood plasma treatment

The energy produced from the Syngas combustion is compared to the energy obtain from combustion of wood consumed. The initial mass of electrode surrounded by beech wood is: m<sub>i</sub> = 4.0g; the total duration of the experiment is 45min and the consumed mass of wood is equal 2.5g.

The heating value of wood is 18.10<sup>3</sup> kJ/mol, so the combustion energy of this mass equal to 46 kJ.

The total volume of gas produced, corresponding to 0.75h, is equal to 7.2L. The composition of gas mixture is: 58% H<sub>2</sub> (46 kJ) and 21% CO (20 kJ).

Taking into account the heating values of H<sub>2</sub> and CO (241 kJ/mol, 283 kJ/mol respectively), we calculate the combustion energy of the gas mixture contained in 7.2L. The energy production is equal to 66 kJ.

The energy combustion of the wood consumed is less compared to that obtained with the combustion of Syngas.

## 7. Discussion

To show a synthetic view of these experiments a global interpretation is given by estimating the maximum and minimum concentrations of hydrogen obtained from cracking, steam reforming, and water gas shift reactions.

The first set of equations (table 4) describes a hypothetical behaviour without CO<sub>2</sub> production (without WGS).

The second ones correspond to a maximum H<sub>2</sub> production with a total conversion of CO by water gas shift reaction.

Estimates are shown in the table 4; one column is dedicated to theoretical value of H<sub>2</sub> (% vol) the other one to an arbitrary calculation taking into account 10% of other molecules in the exhaust gas mixture.

<b>Table 4 : Theoretical and simplified analysis</b>		
<b>Global reactions</b>	<b>H<sub>2</sub> % (vol p<sub>atm</sub>)</b>	<b>H<sub>2</sub> % (vol p<sub>atm</sub>)</b>
<b>Without WGS</b>	<b>Theoretical</b>	<b>+10%mol total</b>
$\text{CH}_3\text{OH} \rightarrow \text{CO} + 2 \text{H}_2$	66	60.6
$\text{C}_2\text{H}_5\text{OH} + \text{H}_2\text{O} \rightarrow 2 \text{CO} + 4 \text{H}_2$	66	60.6
$\text{C}_6\text{H}_5\text{OH} + 5 \text{H}_2\text{O} \rightarrow 6 \text{CO} + 8 \text{H}_2$	57	52
$\text{C}_6\text{H}_9\text{O}_4 + 2 \text{H}_2\text{O} \rightarrow 6.5 \text{H}_2 + 6 \text{CO}$	52	47
<b>Full WGS</b>		
$\text{CH}_3\text{OH} + \text{H}_2\text{O} \rightarrow \text{CO}_2 + 3\text{H}_2$	75	68
$\text{C}_2\text{H}_5\text{OH} + 2\text{H}_2\text{O} \rightarrow 2 \text{CO}_2 + 6 \text{H}_2$	75	65
$\text{C}_6\text{H}_5\text{OH} + 11 \text{H}_2\text{O} \rightarrow 6 \text{CO}_2 \text{ (g)} + 14 \text{H}_2$	70	63.6
$\text{C}_6\text{H}_9\text{O}_4 + 8 \text{H}_2\text{O} \rightarrow 12,5 \text{H}_2 + 6 \text{CO}_2$	68	61

A quick overview of this table shows similar orders of magnitude for hydrogen concentrations regardless of biomass type considered (wood or alcohol). Global results well agree with Figure (3).

WGS reaction is an interesting point because this reaction reduces the amount of CO while increasing the amount of hydrogen.

This reaction takes place differently in various plasma conditions. The above study is of great interest for scientific and also from industrial point of view.

## 8. Conclusion

Alcohol steam-reforming from a non-thermal arc is an interesting pathway to produce H<sub>2</sub> and Syngas. The CO and CO<sub>2</sub> concentrations are in accordance with usual thermo-chemical analysis. The nature of the inlet alcohol does not play a role on the mol% composition of the dry gas at outlet of the reactor.

The results obtained in this study present the first development of the wood treatment using a non-thermal plasma reactor. The flow rate of the hydrogen production is increasing with the electrodes gap. Efficiency of plasma process is increasing with the length of the plasma column. So "Gliding Discharges" can be used to produce large volumes of plasma. The energy produced by the combustion of Syngas is higher than the energy combustion of wood consumed to obtain the Syngas.

This work shows that the biomass treatment using non thermal plasma could be a promising technique for Syngas production. A complete and a large study remain to be developed to improve the chemical and physical efficiency of the plasma reactor.

## 9. References

- [1] L. Shiguang, X. Shaoping, L. Shuqin, Y. Chen, L. Qinghua. 2004 *Fuel Process Technology* 1201
- [2] G. Chen, J. Andries, H. Spliethoff, M. Fang, P. J. van de Enden. 2004 *Solar Energy* 76 345
- [3] H. Qinglan, W. Chang, L. Dingqiang, W. Yao, L. Dan, L. Guiju. 2010 *International Journal of Hydrogen Energy* 35 8884
- [4] K. Aasberg-Petersen, J.-H. Bak Hansen, T.S. Christensen, I. Dybkjaer, P. Seier Christensen, C. Stub Nielsen, S.E.L. Winter Madsen, J.R. Rostrup-Nielsen. 2001 *Applied Catalysis A: General* 221 379
- [5] J.D. Holladay, J. Hu, D.L. King, Y. Wang. 2009 *Catalysis Today* 139 244
- [6] I. Rusu, J-M. Cormier 2003. *Chemical Engineering Journal* 91, 23,.
- [7] I. Rusu, J-M. Cormier. 2003 *International Journal of Hydrogen Energy* 28, 1039,
- [8] O. Aubry, C. Met, A. Khacef, J.M. Cormier. 2005 *Chemical Engineering Journal* 106, 241,.
- [9] J.D. Rollier, J. Gonzalez-Aguilar, G. Petitpas, A. Darmon, L. Fulcheri, R. Metkemeije. 2008 *Energy & Fuels* 22, 556