



**HAL**  
open science

## Simulation of a solar absorption system

Jean-Philippe Praene, Dominique Morau, Franck Lucas, François Garde,  
Harry Boyer

► **To cite this version:**

Jean-Philippe Praene, Dominique Morau, Franck Lucas, François Garde, Harry Boyer. Simulation of a solar absorption system. International Scientific Journal for Alternative Energy and Ecology, 2008, 6 (62), pp.111-118. hal-00847187

**HAL Id: hal-00847187**

**<https://hal.science/hal-00847187>**

Submitted on 23 Jul 2013

**HAL** is a multi-disciplinary open access archive for the deposit and dissemination of scientific research documents, whether they are published or not. The documents may come from teaching and research institutions in France or abroad, or from public or private research centers.

L'archive ouverte pluridisciplinaire **HAL**, est destinée au dépôt et à la diffusion de documents scientifiques de niveau recherche, publiés ou non, émanant des établissements d'enseignement et de recherche français ou étrangers, des laboratoires publics ou privés.

# SIMULATION OF A SOLAR ABSORPTION COOLING SYSTEM

*J.P. Praene\*, D. Morau, F. Lucas, F. Garde, H. Boyer*

Laboratoire de Physique du Bâtiment et des Systemes  
117 rue du Général Ailleret, Tampon, 97430, REUNION  
262 692 23 34 11 / + 262 57 95 41; \*E-mail: praene@univ-reunion.fr

Received: 18 Sept 2007; accepted: 15 Oct 2007

This paper describes the dynamic modeling of a solar absorption cooling plant that will be built for both research and demonstration purposes by the end of 2007. The synchronizing of cooling loads with solar radiation intensity is an important advantage when utilizing solar energy in air conditioning in buildings. The first part of this work deals with the dynamic modeling of an evacuated tube collector. A field of these collectors feed a single-effect absorption chiller of 35 kW nominal cooling capacity. The simulation model has been done in a modular way under TRNSYS16. In a second part, simulation and optimization of the system has been investigated in order to determine the effect of several parameters (collector area, tank volume...) on chiller performance.

**Keywords:** solar collectors, solar refrigerators, solar energy



*J.P. Praene*

**Education:** At the University of Reunion Island, I received the Bachelor of Science degree in Physics in 1999. I then moved to France at Institut National Polytechnique de Lorraine where I received a Masters degree of Mechanical engineering in 2001. The PhD degree in 2007 was made at University of Reunion Island.

**Experience:** Engineer Consultant in Acoustics and Renewable Energy in Buildings (2007). I worked as assistant engineer in LL&A's Consulting (2002). I actually participate to two French research projects: RAFSOL, ORASOL (2006-2008, on solar cooling) and DYNASIMU (2007, on building simulation).

**Main range of scientific interests:** Study of building comfort in hot climates and the use of renewable energy as alternative to face buildings loads.

**Publications:** Dynamic modeling and elements of validation of solar evacuated tube collectors. The Ninth IBPSA Conference and Exhibition, 2005; Simulation and optimization of a solar absorption cooling system using evacuated tube collectors. CLIMA 2007, 2007; Steady state model of an evacuated tube collector – Sensitivity analysis approach. Journal of Solar Energy Engineering, 2007 (under review).

## Introduction

The possible use of solar energy as an alternative heat input for a cooling system has led to several studies of available cooling technologies that use solar energy and was initiated by the technological developments in the solar field [1]. The demand for cooling energy closely matches the availability of solar energy, both in seasonal and the daily variations. A state-of-art of solar absorption cooling systems (SACs) have been proposed [2-4]. An overview of recent development and many projects is also given and control strategy of such plants is approached. Much more investigation has to be done in computer models field in order to improve development of accurate forecast tools to predict SACs performance.

Reunion Island is a French overseas department located in the southern hemisphere characterized by a tropical humid climate. In few years, conventional energy will not be enough to meet the continuously increasing demand of energy. Building remains at the present time the most consuming sector in electricity. Under our

latitudes, the demand for electricity greatly increases because of the extensive use of heating ventilation air conditioning (HVAC) systems, which increase the peak electric load during summer period (November to April). Of share our insularity an orientation towards renewable energies is actually is an attractive concept to obtain an energy independence. This orientation was initiated during 90's, Fig. 1.

One of the many categories of solar cooling systems is the solar absorption cooling. As no CFC are used, absorption systems are friendlier to the environment. At present the market of sorption refrigeration systems is dominated by LiBr-H<sub>2</sub>O systems [5]. Absorption air-conditioning systems are similar to vapor compression air-conditioning systems, but differ in the pressurization stages. In general an absorbent in the low pressure side absorbs an evaporating refrigerant (H<sub>2</sub>O). The most usual combinations of chemical fluids used include lithium bromide-water (LiBr-H<sub>2</sub>O), where water vapor is the refrigerant, and ammonia-water (NH<sub>3</sub>-H<sub>2</sub>O) system where ammonia is the refrigerant [6]. The electric quantity of power consumed by the pump is almost negligible. One needs nevertheless a contribution of heat, Fig. 2.

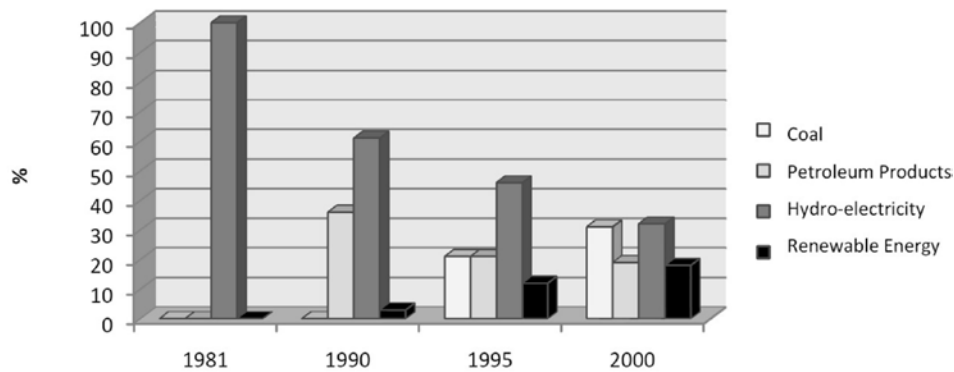

Fig. 1. Evolution of the energy production repartition in Reunion Island since 80's

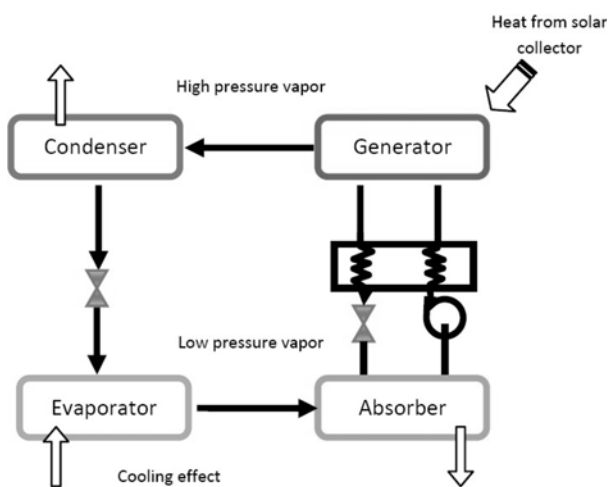

Fig. 2. The basic principle of the absorption air-conditioning system

Single effect absorption chillers require for their operation a hot water temperature on the level of the generator of 80 °C – 150 °C. Moreover, the temperature of cooling water must lie between 7 °C and 43 °C [2]. The higher limit is founded in order to limit the differences in pressure between the generator and the absorber and the condenser and the evaporator. The lower limit makes it possible to avoid the crystallization of lithium bromide which is carried out at low temperature [6].

The main focus of this study is concentrated on the development of dynamic simulation of SACs that can be used for installation design. The purpose of this article is to study the effect of several parameters on the SACs performance. The analysis and optimization is carried out with the TRNSYS 16 software.

### Dynamic evacuated-tube collector (ETC) modeling

Solar collector represent the heart of SACs performance and investments (~ 57%). Thus, an accurate forecast of the solar collector field performance is particularly judicious. This part of the paper deals with the development of ETC dynamic modeling.

There are three types of solar collectors which can be used within the framework of solar cooling: flat-plate, parabolic and vacuum collectors, see Fig. 3. In the present work, an ETC with selective absorber plate surface is considered.

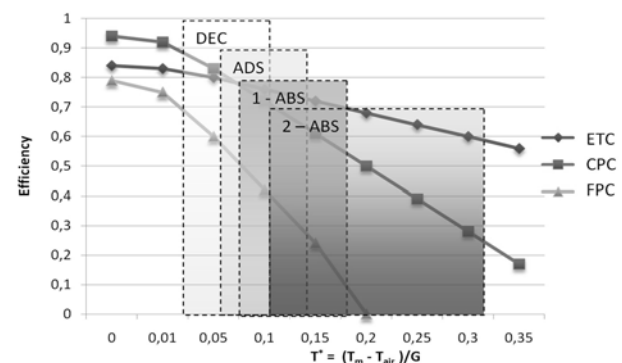

Fig. 3. Comparison of ETC / Compound parabolic / Flat-plate performance for different solar cooling systems (Desiccant / Adsorption / Absorption)

Such collectors are highly efficient due to the fact that the space between the glass and the absorber is evacuated. The main advantage of ETC is the possibility to obtain a good efficiency at high temperature. The studied model consists of vacuum tubes mounted three by three in series. The heat transfer fluid flows in a copper U-tube which is welded to a narrow flat absorber. Thus, the inlet and the outlet are situated at the same end of the ETC, see Fig. 4.

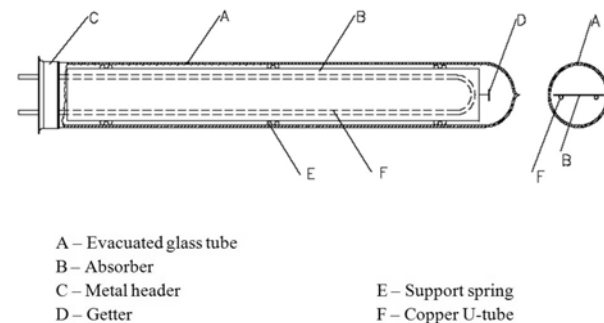

Fig. 4. Evacuated tube collector model

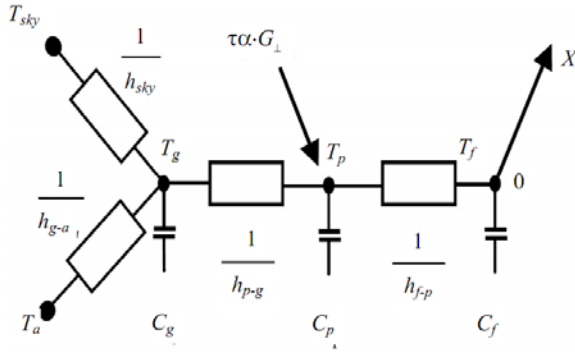

Fig. 5. Thermal networks for the 3-node dynamic model

The literature contains numerous works on the modeling of solar collectors. These models developed have different levels of complexity. Usually, solar collectors are described by stationary models, considering the collector working under steady-state conditions. These approaches are generally based on the work of Klein [7]. A number of simplifying assumptions have to be made for the modeling. Most of these have been previously described by Duffie [8]:

- material properties are not dependent on temperature;
- temperature gradients along the absorber length can be neglected;
- temperature gradients inside the glass cover is assumed to be negligible;
- dust and pollution over the collector can be neglected;
- perfect insulation at the edges of the collector is assumed.

The model (Fig. 5) consists on three nodes corresponding to the fluid, the absorber plate and the transparent glass

cover. It is considered that the temperature of the fluid is a function of  $x$ . The fluid is moving in a single channel with the velocity  $u$ , along  $x$ -axis.

Applying heat balances at different parts of the collector, the temperature in the nodal points can be described by a set of three differential equations:

$$C_g \frac{\partial T_g}{\partial t} = \epsilon_g \sigma (T_{sky}^4 - T_g^4) + h_{g-a} (T_a - T_g) + \epsilon_g \sigma (T_p^4 - T_g^4) \quad (1)$$

$$C_p \frac{\partial T_p}{\partial t} = \tau \alpha G_{\perp} + \epsilon_g \sigma (T_g^4 - T_p^4) + h_{f-p} (T_f - T_p) \quad (2)$$

$$C_f \left( \frac{\partial T_f}{\partial t} + u \frac{\partial T_f}{\partial x} \right) = h_{f-p} (T_p - T_f). \quad (3)$$

The details of the model developed and elements of validation associated have been previously described by Praene [9]. A comparison between model forecast and measurements is presented in Fig. 6. The simulation is carried out at the minute time step. A new type has been created under TRNSYS, in order to coupling with the rest of the solar cooling system. We have chosen to numerically solve this system using finite difference approach. In this case, the collector is defined as single fluid channel, which is divided into  $N$  segments.

The differential equation system is solved for each of segments using a Total Variation Diminishing scheme based on Lax Wen Droff Method. The final outlet temperature obtain for segment  $(xi-1)$  is the initial or inlet fluid temperature for segment  $xi$ . The final outlet temperature is obtained by connecting the  $N$  segments of the collector.

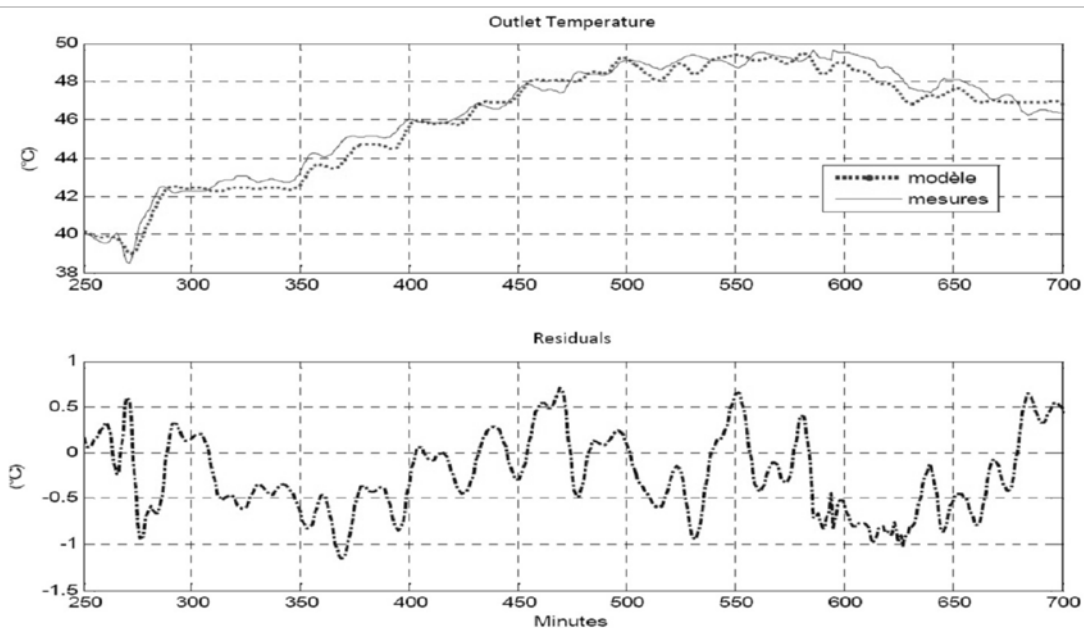

Fig. 6. Comparison between measurements and model prediction at minute time step

### Thermal building simulation

A detailed building thermal simulation software is employed for the modeling of the different studied zone. This software called CODYRUN, developed in our laboratory, is both regrouping a design and research aspects. The description of this software has already been covered in various publications [10-13]. The CODYRUN program was translated under TRNSYS 16 environment in order to replace the TYPE 56 subroutine. The main advantages are a good accuracy for short time step (less than the hour) and several tests have been carried out to validate the code for tropical humid climates. One of the most important developments is the dynamic link between cold production for absorption and the building loads. Thanks to CODYRUN, as we simulate at short time step (1/8 hour), thus it is possible to observe the impact of variation of cooling rate on air temperature inside the building.

The different studied zones are classroom of the Civil Engineering Department of University of Reunion Island. The first step of simulation is about evaluate air temperature inside classroom under natural ventilation

during one year. An accurate climatic database is needed for the study. The meteorological database from our experimental setup was used. The department becomes located close to sea level (50 meters high).

As shown at Fig. 7, the period from May to October corresponding to our southern winter offering natural comfort condition. A temperature lower than 25 °C is fixed as thermal comfort condition inside classroom relative humidity is also an important factor for comfort. In reality, no direct control of humidity rate is possible on absorption chiller. However, many researches were carried out by the researchers in order to create simplified tools of indication of comfort [14-15]. We were thus based on the computation results of these comfort index within the framework of our simulations over the whole year, in order to determine the interesting building load period to study. The starting point for the definition of the levels of comfort is based on the value recommended of PMV\* (Predicted Mean Vote). That involves values of  $-0.5 < PMV^* < +0.5$ . Regarding our work, only the positive part is considered. Fig. 8 presents the PMV\* evolution and confirms the same period of natural comfort shown previously.

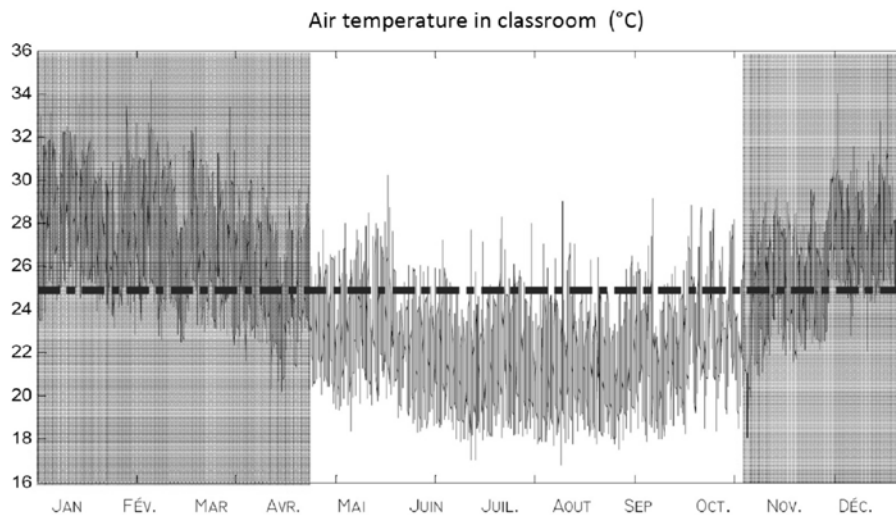

Fig. 7. Yearly evolution of air temperature in classroom

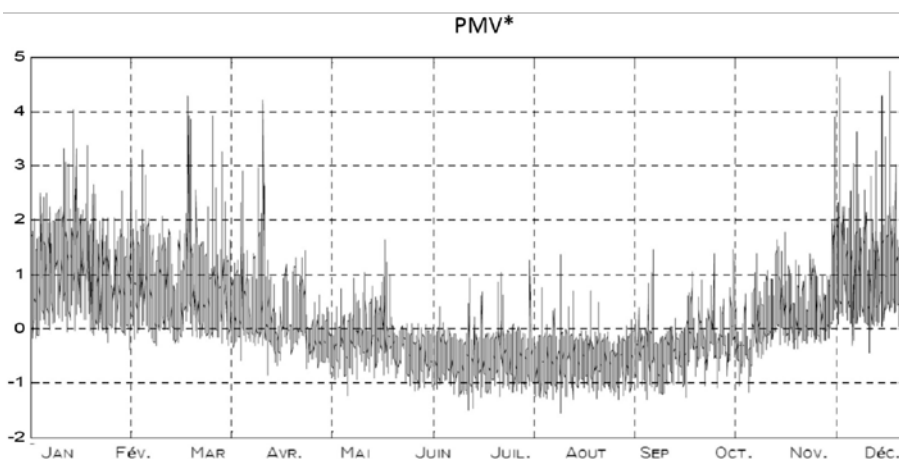

Fig. 8. Yearly evolution of PMV\* in classroom under natural ventilation condition

The period from November to April is clearly identify as cooling period. In a second time, CODYRUN ensured in the evaluation of building loads during summer. January was chosen as month of reference. Simulations were carried out for the classroom using the following assumptions:

- Inside air temperature of 25 °C.
- Relative humidity of 55 %.

As presented on Fig. 9 the maximum classroom load is 9.5 kW. This peak occurs after midday that is due to the inertia of the building and consequently restitution of this heat. Thus, for all the classrooms of the Civil Engineering Department a 35 kW absorption chiller is necessary. Simula has been extended to the summer period in order to determine a daily cooling rate for the classroom. The maximum value is 1.2 kW·h/m<sup>2</sup>·day during January, see Fig. 10.

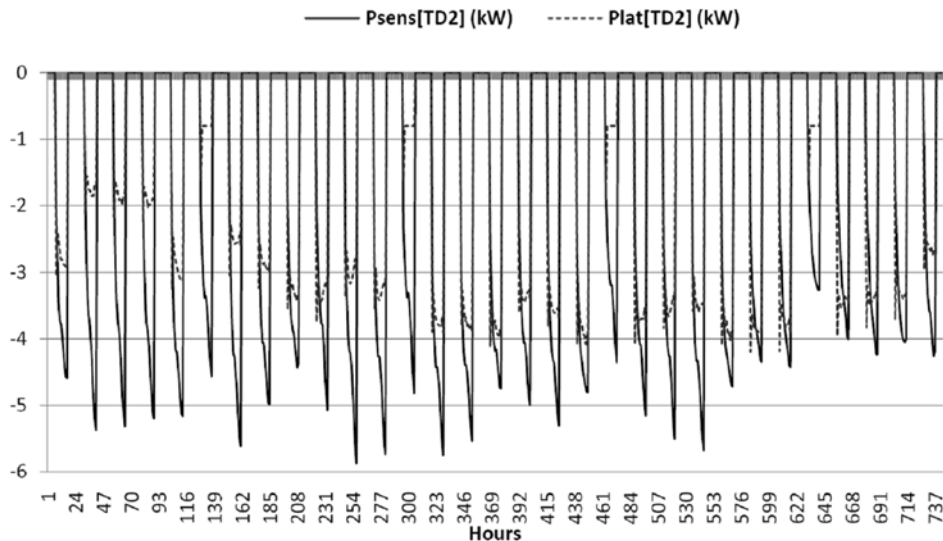

Fig. 9. Sensible and latent power called by a classroom during January

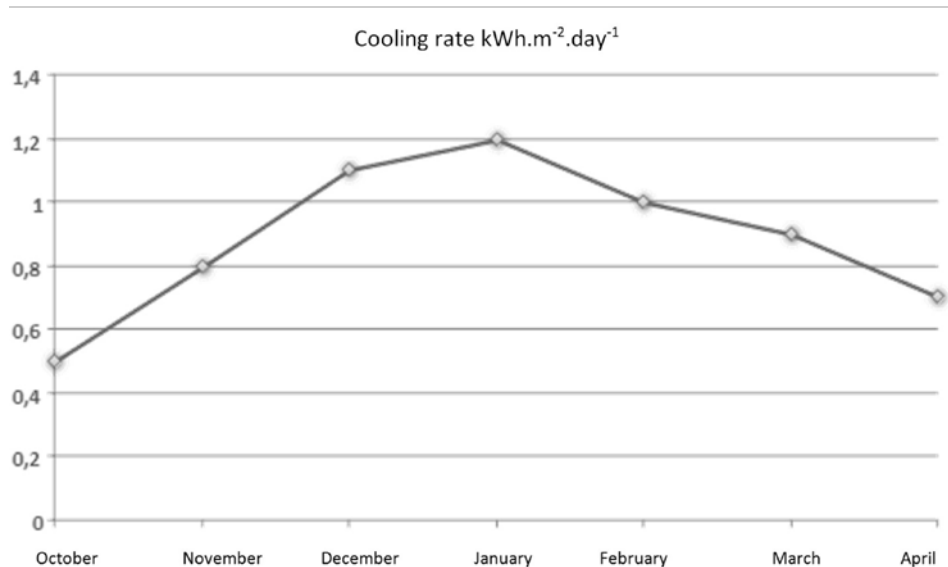

Fig. 10. Daily average cooling demand for a classroom

### Absorption cooling system simulation

This section presents the principal results obtain under TRNSYS for simulation of the global solar absorption cooling system. This program consists of the use of several “subroutines” which represents the components of the system described by ordinary or algebraic

equations. The LiBr–water absorption air conditioner employed is a single-effect unit, based on Arkla model WF-36. Auxiliary heater is not used. Two new types were added to the existing models under TRNSYS. It is about the model of simulation of the building and the model of vacuum collector. The useful surface area of collector used during simulation is 60 m<sup>2</sup>. The storage of

hot water uses Type 38. That corresponds to a vertical roll of 800 L made up of copper insulated thematically with polyurethane. A sequence of January is considered in order to carry out our simulation, as shown on Fig. 11 and 12.

The average temperature in classroom is near 27 °C during the day. The difference between inside and outside air temperature is about 4 °C.

Absorption chiller works without additional contribution of an auxiliary heat unit. As we can see on Fig. 12, the 60 m<sup>2</sup> of ETC is enough to meet the minimum inlet temperature of 80 °C for the generator. If the inlet temperature is too low, the water flows through a by pass to the solar loop to be heat again.

A number of simulation are carried out in order to evaluate the effect of various parameters on the performance of the system. All runs consider the meteorological data of University during January. One of the most important points from an economic point of view of a solar cooling plant is the solar loop. The field of solar collectors accounts for approximately 60 % of the total investment (in particular if it is vacuum collector). So it is important to dimension in a first place the needs for the building then the total surface of the field of solar collectors. Three points go in general to the decision of the field of solar collectors:

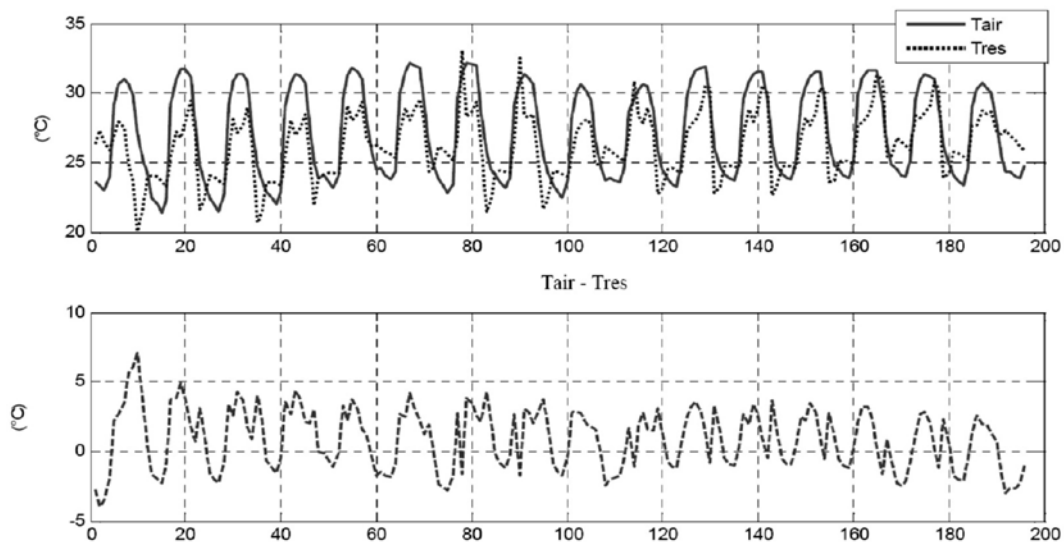

Fig. 11. Comparison between inside air temperature ( $T_{res}$ ) and outside air temperature ( $T_{air}$ )

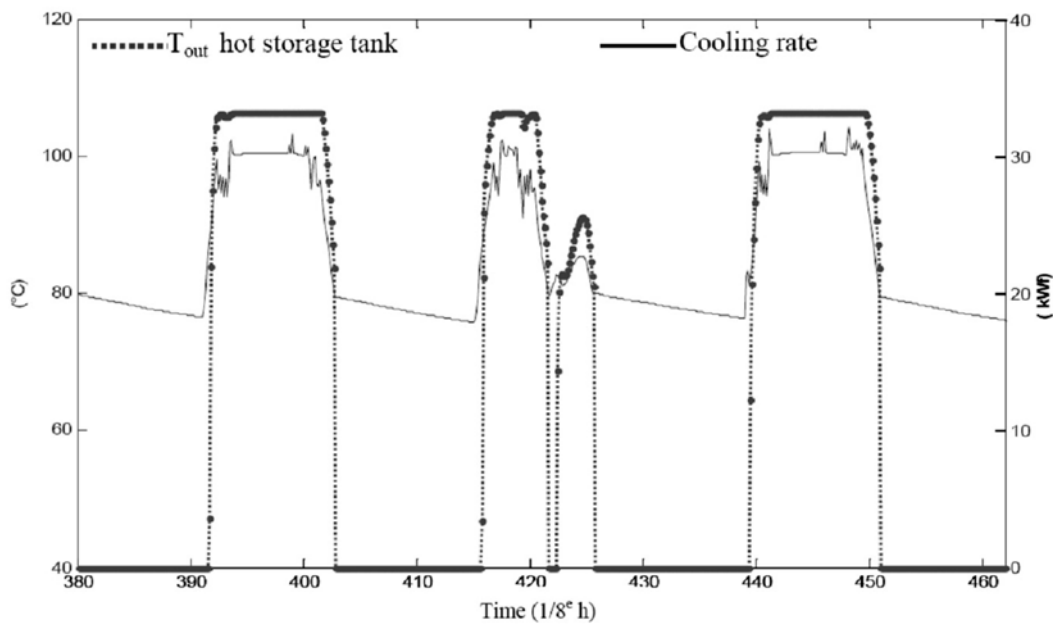

Fig. 12. Evolution of absorption chiller cooling rate and outlet temperature of hot water storage tank

- Economic constraint: Budget dedicated to the project.
- Space constraint: surface available for the solar field.
- Weather constraint: average numbers of good days during the hot period.

Also, it is important to quantify the influence of the elements of the solar loop, of as much we are in the case of an operation of solar cooling, without auxiliary contribution.

Many tests have been investigated to evaluate the sensitivity of the machine performance for different volume of storage tank, see Fig. 13. For a volume superior than 2.5 m<sup>3</sup>, the outlet temperature is lower than 80 °C, thus the cold production will stop. Storage volume plays a dominating part because it has a buffering effect to the abrupt weather variations and makes possible to continue the hot water supply of absorption chiller. The total solar collector area is the most important point (performance and economy). Several area of solar collectors have been tested (Fig. 14.)

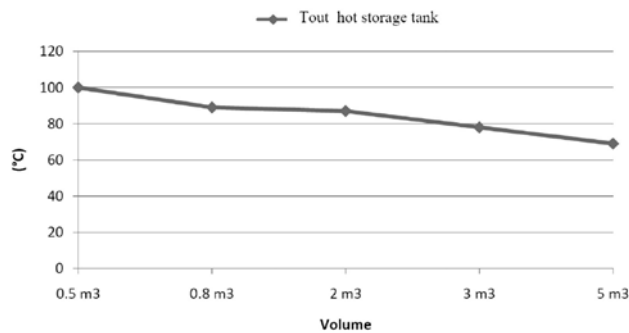

Fig. 13. Effect of tank size on hot water temperature for generator

The effect of solar collector is evaluated against the energy rate from absorption chiller. The cooling rate from 60 m<sup>2</sup> to 40 m<sup>2</sup> is near. This production reaches to low value for a solar area less than 20 m<sup>2</sup>. Thus, to have continuous condition for cold production a collector area of 60 m<sup>2</sup> is required.

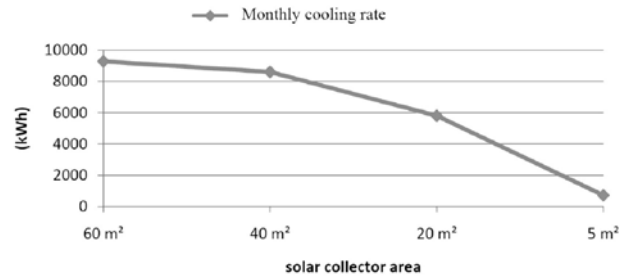

Fig. 14. Energy production from absorption chiller for different solar collector areas

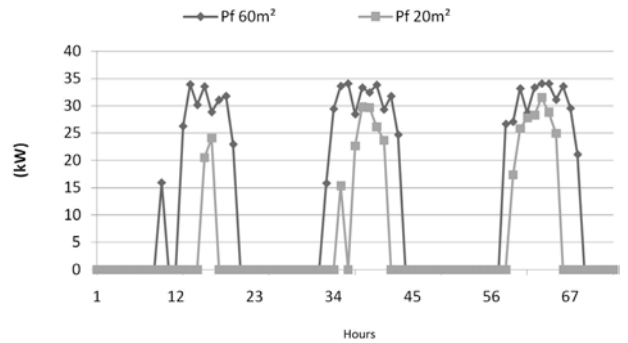

Fig. 15. Cooling rate for 60 and 20 m<sup>2</sup> of ETC surface area

As shown on Fig. 15, 20 m<sup>2</sup> of ETC create an intermittent working. The cold production is not available during the all day, furthermore the cooling rate is lower than the second case. Same conditions has been considered to evaluate the effect of solar collectors are on air temperature inside the classroom.

Inside air temperature (Tres) is higher than outside temperature (Tair ext), see Fig. 16. A solar collectors surface area of 20 m<sup>2</sup> is clearly not enough to meet comfort conditions in the building. This results shows the dynamic link between cooling rate and inside air temperature.

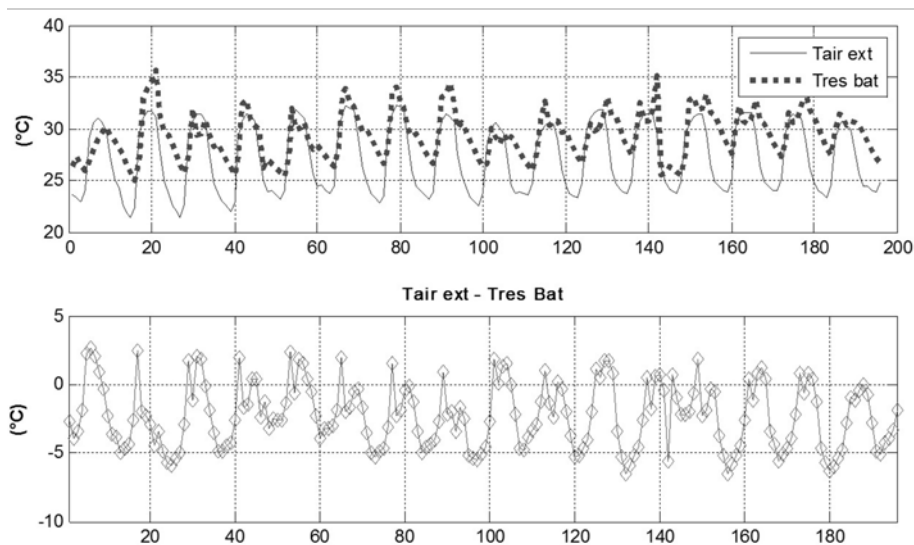

Fig. 16. Impact of 20 m<sup>2</sup> collector on inside air temperature (Tres)



## Conclusion

The aim of this work is to present the development of a dynamic model of a solar cooling plant. The system is modeled with the TRNSYS program. For the requirements in cooling for classrooms, an optimum of the components consists of the use of 60 m<sup>2</sup> of vacuum solar collectors associated a storage tank of 0.8 m<sup>3</sup>. We also fixed the nominal capacity of the absorption chiller with 33 kW. The final objective of this work was to set up a simulation tool representing a solar cooling plant. This environment will be used as basic support with the simulation of various configurations. The developed program can be used both for design and research studies. These simulations have been used to dimensioning an installation at University. The cooling plant will be setup on November 2007, in order to be in function in summer. This experiment will bring important element of validation on the different components of the solar cooling plant simulation.

## Nomenclature

$C_f$  – fluid heat capacity  
(J/m<sup>2</sup>· K)  
 $C_g$  – heat capacity of glass cover  
(J/m<sup>2</sup>· K)  
 $C_p$  – heat capacity of absorber  
(J/m<sup>2</sup>· K)  
 $G_{\perp}$  – global solar irradiance in the plane of the collector  
(W/m<sup>2</sup>)  
 $h_{f-p}$  – heat transfer coefficient fluid – absorber  
(W/m<sup>2</sup>· K)  $h_{g-a}$  – heat transfer coefficient glass – ambient  
(W/m<sup>2</sup>· K)  $h_{sky}$  – heat transfer coefficient glass – sky  
(W/m<sup>2</sup>· k)  
 $T_a$  – ambient temperature (°C)  
 $T_{sky}$  – sky temperature (°C)  
 $u$  – fluid velocity (m/s)  
 $v$  – wind velocity (m/s)

## Greek symbols

$\alpha$  – absorptivity coefficient  
 $\varepsilon$  – emissivity  
 $\sigma$  – Stefan-Boltzmann constant (5.67· 10<sup>-8</sup> W· m<sup>-2</sup>· K<sup>-4</sup>)

## Subscripts

$f$  – fluid  
 $g$  – glass  
 $p$  – absorber plate

## References

1. Tabor H.Z. Use of solar energy for cooling purposes // Solar Energy. 1962. Vol. 6. P. 136-141.
2. Henning H.-M. Solar assisted air conditioning of buildings – an overview // Applied Thermal Engineering. 2007. Vol. 27, No. 10. P. 1734–1749.
3. Florides G.A., Tassou S.A., Kalogirou S.A., Wrobel L.C. Review of solar and low energy cooling technologies for buildings // Renewable Sustainable Energy Rev. 2002. Vol. 6. P. 557–572.
4. Fan Y., Luo L., Souyri B. Review of solar sorption refrigeration technologies: Development and applications // Renewable and Sustainable Energy Reviews. 2007. Vol. 11, No. 8. P. 1758-1775.
5. Lamp P., Ziegler F. Review paper, European research on solar assisted AC, Elsevier Science Ltd. and IIR. 1998.
6. Dorgan C.B., Leight S.P., Dorgan C.E. ASHRAE. Handbook of fundamentals. Application guide for absorption cooling/refrigeration using recovered heat. American Society of Heating, Refrigerating and Air Conditioning Engineers. 1995.
7. Klein S.A, Duffie J.A., Beckman W.A. Transient considerations of a flat-plate solar collectors // ASME. J. Eng. Power. 1974. Vol. 96A. P. 109-113.
8. Duffie J.A., Beckman W.A. Solar engineering of thermal processes, 2nd edition, 1991.
9. Praëne J.P., Garde F., Lucas F. Dynamic modelling and elements of validation of a solar evacuated tube collector. Building Simulation. 2005. P 953–960.
10. Boyer H. Conception thermo-aerologique de Batiments multizones proposition d'un outil à choix multiples de modèles. PhD Thesis, INSA de Lyon, France. 1993.
11. Boyer H., Garde F., Brau J.C., Gatina J.C. A multi model approach of thermal building simulation for and research approach // Energy and Building. 1998. Vol. 28. P. 71-78.
12. Boyer H., Chabriat J.P., Grondin Perez B., Tourrand C., Brau J. Thermal building simulation and computer generation of nodal models // Building and Environment. 1996. Vol. 31, No. 3. P. 207–214.
13. Boyer H., Lauret A.P., Adelard L., Mara T.A. Building ventilation: a pressure airflow model computer generation and elements of validation // Energy and Buildings. 1999. Vol. 29. P. 283–292.
14. Gagge A.P., Fobelets A., Berglund L.G. A standard predictive index of human response to the thermal environment // ASHRAE Trans. 1986. Vol. 92 (2B). P. 709-731.
15. Humphreys M.A., Fergus Nicol J. The validity of ISO-PMV for predicting comfort votes in every day thermal environments // Energy and Buildings. 2002. Vol. 34, No. 6. P. 2553-2565.