



HAL
open science

MODal ENergy Analysis

Nicolas Totaro, Jean-Louis Guyader

► **To cite this version:**

Nicolas Totaro, Jean-Louis Guyader. MODal ENergy Analysis. RASD, Jul 2013, Pise, Italy. hal-00841467

HAL Id: hal-00841467

<https://hal.science/hal-00841467>

Submitted on 5 Jul 2013

HAL is a multi-disciplinary open access archive for the deposit and dissemination of scientific research documents, whether they are published or not. The documents may come from teaching and research institutions in France or abroad, or from public or private research centers.

L'archive ouverte pluridisciplinaire **HAL**, est destinée au dépôt et à la diffusion de documents scientifiques de niveau recherche, publiés ou non, émanant des établissements d'enseignement et de recherche français ou étrangers, des laboratoires publics ou privés.

MODAL ENERGY ANALYSIS

Nicolas Totaro^{1*}, Jean-Louis Guyader¹

¹Laboratoire Vibrations Acoustique (LVA)
INSA de Lyon
25bis, avenue Capelle
F69621 Villeurbanne Cedex, France
E-mail: nicolas.totaro@insa-lyon.fr

Keywords: Energy methods, non resonant, pure tone, Statistical Energy Analysis, MODENA.

ABSTRACT

The Modal Energy Analysis presented in this paper is a method to predict energy exchanges between vibro-acoustic subsystems. As well-known methods like Statistical Energy Analysis (SEA) or Statistical modal Energy distribution analysis (SmEdA), the proposed method is based on equations of motion of two coupled oscillators. However, these equations are here solved in narrow band. The net exchanged power between the two coupled oscillators is then proportional to the total energies of oscillators using a pure tone modal coupling loss factor. Extending it to the case of two continuous coupled subsystems (using dual modal formulation), it yields a system of linear equations linking modal injected power to modal energies of subsystems at a particular frequency. In that way, the non-resonant contribution of modes is intrinsically taken into account. In the present paper, the theoretical background of the proposed method will be explained and assumptions and domain of validity will be identified. Finally, numerical simulations on a plate/cavity and a cavity/plate/cavity test case will be addressed. A numerical example of a ribbed plate coupled to a cavity will be also presented.

1. INTRODUCTION

To compute the response of a vibro-acoustic system two main families of methods are available: deterministic or statistical methods. Deterministic methods mainly represented by finite element method permit to solve the response of the whole system whatever its complexity (provided that materials and couplings are well represented by elements). However, this method is well adapted for low to medium frequency because of the discretization of the geometry into elements that depends on frequency. Indeed, the number of degrees of freedom increases with frequency as well as the number of modes to solve.

Contrary, the statistical methods as Statistical Energy Analysis (SEA) [1], often based on energy, are well adapted to high frequency band but rely on constraining assumptions that limits their domain of validity [2]. However, when assumptions are fulfilled, SEA quickly provides interesting information on energy exchanges between subsystems.

SmEdA approach [3, 4] is a method in between finite element method and SEA. As SmEdA is based on energy exchanges between modes of subsystems, it is possible to use

finite element models of uncoupled subsystems to compute modal coupling loss factors. SmEdA thus overcomes the assumption of equipartition of modal energy needed in SEA.

However, as in classical SEA, the non resonant contribution of modes was not initially taken into account. It is now possible, as Maxit has recently demonstrated it, to take into account non resonant contribution of modes in the case of a Cavity/Structure/Cavity system introducing indirect coupling between cavities [5].

The present article deals with an energy method [6] developed in the same framework as SmEdA approach (modal energy) but solved in narrow band. As will be demonstrated, a power balance can be written at pure tone and the net exchanged power can be linked to modal energies by a pure tone coupling factor. This method will be validated and illustrated by numerical examples: Plate/Cavity and Cavity/Plate/Cavity test cases.

The definition of pure tone coupling loss factor will lead to a discussion about weak coupling definition and a criterion defined at pure tone will be proposed.

2. POWER BALANCE BETWEEN OSCILLATORS

2.1 System under study

Let's take the case of two oscillators (masses M_1 and M_2 , springs K_1 and K_2 and dampers λ_1 and λ_2) as presented in figure 1. Both masses are excited by uncorrelated forces F_1 and F_2 .

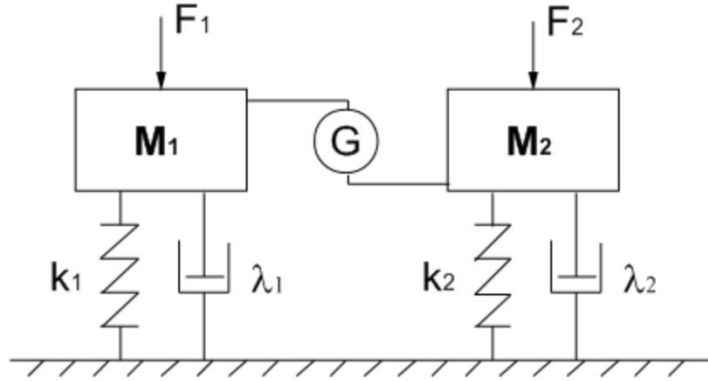

Figure 1: Oscillators coupled by a gyroscopic coupling and excited by uncorrelated forces

The gyroscopic coupling is characterized by

$$G = \sqrt{M_1 M_2} \gamma \quad (1)$$

where γ is the gyroscopic coupling coefficient.

In that case, the equations of motion of masses write

$$\ddot{y}_1(t) + \frac{\lambda_1}{M_1} \dot{y}_1(t) + \frac{k_1}{M_1} y_1(t) - \sqrt{\frac{M_2}{M_1}} \gamma \dot{y}_2(t) = \frac{f_1(t)}{M_1} \quad (2)$$

and

$$\ddot{y}_2(t) + \frac{\lambda_2}{M_2} \dot{y}_2(t) + \frac{k_2}{M_2} y_2(t) + \sqrt{\frac{M_1}{M_2}} \gamma \dot{y}_1(t) = \frac{f_2(t)}{M_2} \quad (3)$$

where $y_1(t)$ and $y_2(t)$ are the temporal displacement of masses. In frequency domain, these equations can be written in a matrix form $AY = F$. Solving this system of equations, one can easily define transfer functions $H_{11}(\omega)$, $H_{12}(\omega)$, $H_{21}(\omega)$ and $H_{22}(\omega)$ where $H_{ij}(\omega)$ denotes the transfer function between mass M_i and force F_j .

Finally, the responses of masses to both forces simply write

$$Y_1(\omega) = H_{11}(\omega)F_1(\omega) + H_{12}(\omega)F_2(\omega) \quad (4)$$

and

$$Y_2(\omega) = H_{21}(\omega)F_1(\omega) + H_{22}(\omega)F_2(\omega) \quad (5)$$

2.2 Kinetic energy of oscillators

The kinetic energy of oscillators can be expressed as a function of displacement of masses as

$$E_i^k(\omega) = \frac{1}{4} M_i \omega^2 \Re(Y_i(\omega) Y_i^*(\omega)) \quad (6)$$

where $i=1,2$ and the star denotes the complex conjugate.

Considering two uncorrelated forces ($F_1 F_2^* = F_1^* F_2 = 0$), the kinetic energies of masses can be expressed as a function of transfer functions

$$E_i^k(\omega) = \frac{1}{4} M_i \omega^2 (|H_{ii}(\omega)|^2 S_i(\omega) + |H_{ij}(\omega)|^2 S_j(\omega)) \quad (7)$$

where $S_i(\omega)$ and $S_j(\omega)$ are force auto-spectra.

2.2 Potential energy of oscillators

In the same manner, the potential energies of oscillators can be expressed as a function of transfer functions

$$E_i^p(\omega) = \frac{1}{4} K_i (|H_{ii}(\omega)|^2 S_i(\omega) + |H_{ij}(\omega)|^2 S_j(\omega)) \quad (8)$$

Considering the total energy as the sum of kinetic and potential energies, one can express force auto-spectra as a function of total energies of oscillators solving for each frequency the following system of equations

$$\begin{bmatrix} |H_{ii}|^2 & |H_{ij}|^2 \\ |H_{ji}|^2 & |H_{jj}|^2 \end{bmatrix} \begin{Bmatrix} S_i \\ S_j \end{Bmatrix} = \begin{Bmatrix} \frac{4E_t^i}{M_i(\omega + \omega_i^2)} \\ \frac{4E_t^j}{M_j(\omega + \omega_j^2)} \end{Bmatrix} \quad (9)$$

2.3 Net exchanged power between oscillators

The net exchanged power transmitted from oscillator i to oscillator j is here only due to gyroscopic coupling:

$$\Pi_{ij}(\omega) = \frac{-1}{2} G \omega^2 \Re(Y_2^*(\omega) Y_1(\omega)) \quad (10)$$

and can also be expressed as a function of transfer functions

$$\Pi_{ij}(\omega) = \frac{-1}{2} G \omega^2 \Re(H_{ji}^*(\omega) H_{ii}(\omega) S_i(\omega) + H_{jj}^*(\omega) H_{ij}(\omega) S_j(\omega)) \quad (11)$$

Finally, introducing expressions of $S_i(\omega)$ and $S_j(\omega)$ obtained with equation (9) in equation (11), one can express the net exchanged power between oscillators as a function of total energies of oscillators

$$\Pi_{ij}(\omega) = \alpha_{ij}(\omega) E_t^i(\omega) - \alpha_{ji}(\omega) E_t^j(\omega) \quad (12)$$

where $\alpha_{ij}(\omega)$ is a pure tone modal coupling loss factor whose expression writes

$$\alpha_{ij}(\omega) = \frac{2\gamma^2}{M_i(\omega_i^2 + \omega^2)} \frac{\Re(H_{ji}^* H_{ii}) |H_{jj}|^2 - \Re(H_{jj}^* H_{ij}) |H_{ji}|^2}{|H_{ii}|^2 |H_{jj}|^2 - |H_{ij}|^2 |H_{ji}|^2} \quad (13)$$

Considering the classic expressions of transfer functions $H_{ij}(\omega)$ of two coupled oscillators, this coupling loss factor can be expressed as a function of damping bandwidth $\Delta_i = \eta_i \omega_i$ (η_i is the damping ratio) and angular eigen-frequency ω_i of oscillator i

$$\alpha_{ij}(\omega) = \frac{2\gamma^2}{(1 + \frac{\omega_i^2}{\omega^2})} \frac{\Delta_j \omega^2 ((\omega_i^2 - \omega^2)^2 + \omega^2 \Delta_i^2) + \omega^4 \gamma^2 \Delta_i}{((\omega_i^2 - \omega^2)^2 + \omega^2 \Delta_i^2) ((\omega_j^2 - \omega^2)^2 + \omega^2 \Delta_j^2) - \omega^4 \gamma^4} \quad (14)$$

2.4 Extension to multi-modal subsystems

Let's consider two sets of modes N_p and N_q representing two coupled continuous subsystems as presented in Fig. 2. Using a dual modal formulation, as done in SmEdA approach, a power balance for each mode of a set of modes coupled to another set of modes can be written. Modes of the uncoupled subsystems are expressed either in terms of displacement (free at the coupling interface) or in terms of stress (blocked at the coupling interface). In that case, there

is no coupling between two modes of the same subsystem and the coupling between two modes of different subsystems is gyroscopic. This is due to the chosen formulation stress/displacement of the dual modal formulation and this is why only gyroscopic coupling is taken into account in previous section. This choice, already done in SmEdA, is explained in [3].

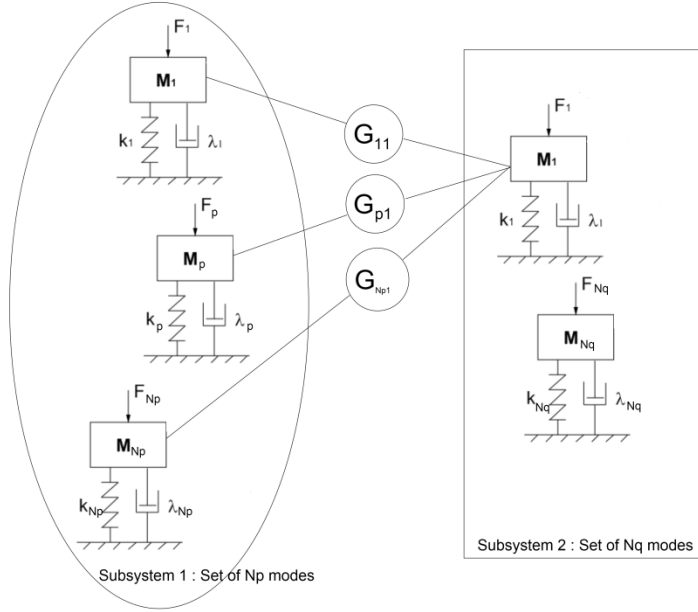

Figure 2 : Coupling between two sets of modes

It has been demonstrated that the modes of subsystems can be considered as sets of oscillators and that the power injected into mode p , $\Pi_p^{inj}(\omega)$, is either dissipated by the modal damping loss factor or transmitted to modes q of a set of modes N_q as presented in equation (15):

$$\Pi_p^{inj}(\omega) = \Pi_p^{diss}(\omega) + \sum_q \alpha_{pq}(\omega) E_p^t(\omega) - \sum_q \alpha_{qp}(\omega) E_q^t(\omega) \quad (15)$$

where the power dissipated by mode p is

$$\Pi_p^{diss}(\omega) = 2\eta_p \omega_p \frac{E_p^t(\omega)}{(1 + \frac{\omega^2}{\omega_p^2})} \quad (16)$$

in case of viscous damping.

The gyroscopic coefficient γ_{pq} between mode p of subsystem 1 and mode q of subsystem 2 is proportional to the modal work between modes, expressed here in the case of a Plate/Cavity coupling

$$\gamma_{pq} = \frac{1}{\sqrt{M_p M_q}} \int_{S_c} \Phi_p(M) \Psi_q(M) dM \quad (17)$$

where S_c is the coupling surface between the plate and the cavity, $\Phi_p(M)$ is the displacement mode shape of the plate, $\Psi_q(M)$ is the pressure mode shape of the cavity and M_p and M_q are the modal masses.

To apply this power balance equation on two sets of oscillators, some assumptions have to be fulfilled:

- (i) the coupling between two modes has to be conservative.
- (ii) External forces applied on subsystems have to be uncorrelated.
- (iii) Isolating two modes, the ensemble of coupling forces due to other modes of the subsystems are considered as uncorrelated to external excitations.

The assumption (iii) may be satisfied if the coupling is weak between both subsystems and/or if the coupling forces can be considered as forces with randomly distributed phase.

4. PLATE/CAVITY TEST CASE

To illustrate and validate this approach, a Plate/Cavity test case is addressed. As presented in figure 3, a plate excited by a point force at $(X_e, Y_e, 0)$ is coupled to a cavity (dimensions $L_x \times L_y \times L_z$). The characteristics of the plate and the cavity can be found in Tables 1 and 2.

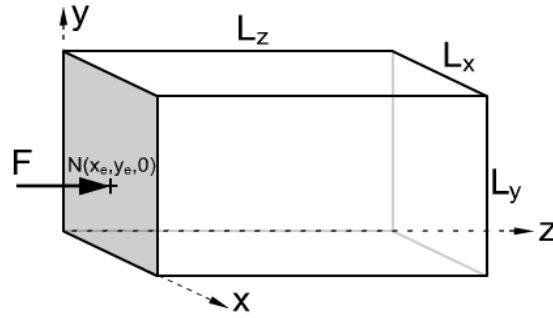

Figure 3 : Plate/Cavity test case

Length L_x (m)	1
Width L_y (m)	1
Thickness h (mm)	10
Young Modulus (Pa)	$2e11$
Density (kg/m ³)	7800
Poisson's coefficient	0,3
damping	0,01

Table 1: Characteristics of the plate

Length L_x (m)	1
Width L_y (m)	1
Depth (m)	1
Sound speed (m/s)	340
Density (kg/m ³)	1,2
damping	0,01

Table 2: Characteristics of the cavity

For each frequency, a system of $(N_p + N_q)$ equations (15) has to be solved. The unknowns are here the modal energies at angular frequency ω .

Figure 4 presents the computed modal energies of modes of the plate and the cavity as function of frequency.

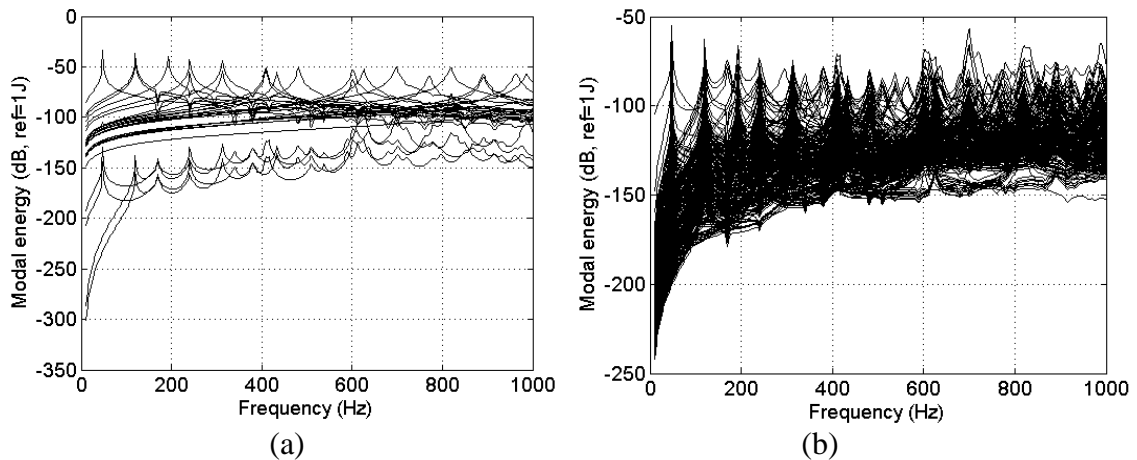

Figure 4: modal energies of (a) the plate and (b) the cavity as function of frequency. The plate is excited by a point force.

As can be seen in figure 4(a), some modes of the plate have low energy on the whole frequency range. This is due to the position of the point force which is close to a nodal line of these modes. In that case, the assumption of equipartition of modal energy is not fulfilled neither in the plate nor in the cavity.

Summing all the modal energies, one can obtain the total energies of subsystems as a function of frequency. The total energies obtain with MODENA (MODal ENergy Analysis) approach is compared to a reference calculation [7] in figure 5.

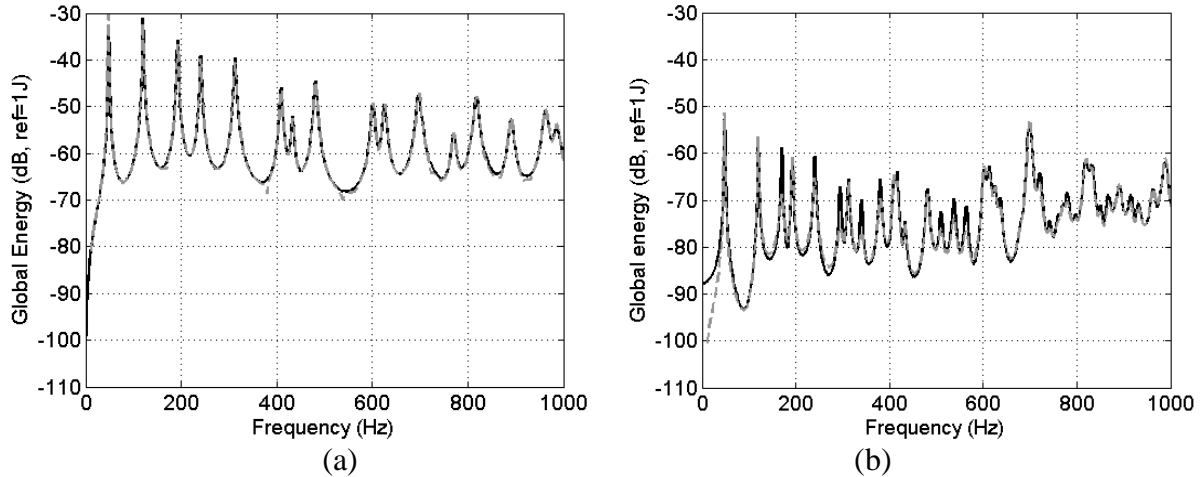

Figure 5: total energies of (a) the plate and (b) the cavity as function of frequency. Solid black line: reference calculation; dashed gray line: MODENA. The plate is excited by a point force.

As can be seen in figure 5, the comparison between MODENA and the reference calculation is very good even if the plate is excited by a point force. This example clearly validates the MODENA approach.

Compared to SmEdA approach, MODENA gives more information on energy responses of the subsystems (picks due to the eigen frequencies for example) and rely only on the assumption of uncorrelated modal forces. SmEdA is based on the same assumptions as SEA except equipartition of energy.

As the sum over modes is not restrained in MODENA, the influence of all the modes of the uncoupled subsystems are taken into account and the non resonant transmission can thus be well-estimated.

However, as all modes of uncoupled subsystems have to be taken into account, the system of equations to solve in MODENA can be huge. This is the main criticism that can be made to MODENA approach which moves away from SEA point of view. If all modes have to be taken into account, even if it is modes of uncoupled subsystems, one can think that this method has the same drawbacks as FEM. This is partially true but as in SmEdA, MODENA can be viewed as a tool to post-process FE data and to find, for example, couples of modes which are mainly responsible of energy exchanges between subsystems. In addition, in case of acoustic subsystems, some reduction technique can be easily introduced. The simplest technique is to use a sliding sum for modes of cavities because only low frequency modes of the structure are mainly responsible of non resonant transmission as demonstrated in [5]. This kind of techniques will be applied in future works.

5. CAVITY/PLATE/CAVITY TEST CASE

Let's consider the Cavity/Plate/Cavity test case presented in figure 6. In this test case, a simply supported rectangular plate is placed in between two air filled cavities. The characteristics of the Plate and both cavities can be found in Tables 3 and 4. A monopole is acting in cavity A at (0,1 ; 0,1 ; 0,1)m.

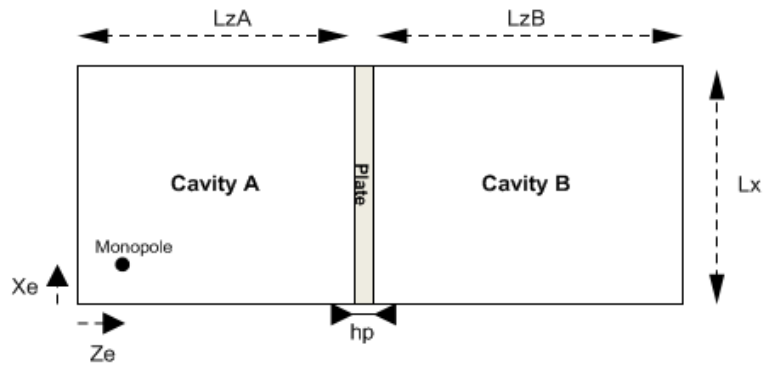

Figure 6 : Cavity/Plate/Cavity test case.

Length Lx (m)	0,9
Width Ly (m)	0,7
Thickness h (mm)	5
Young Modulus (Pa)	2e11
Density (kg/m ³)	7800
Poisson's coefficient	0,3
damping	0,01/0,05

Table 3: Characteristics of the plate

	Cavity A	Cavity B
Length Lx (m)	0,9	0,9
Width Ly (m)	0,7	0,7
Depth (m)	1	1,2
Sound speed (m/s)	340	340
Density (kg/m ³)	1,2	1,2
damping	0,01	0,01

Table 4: Characteristics of the cavities

Figure 7 illustrates the influence of damping of the plate (here 1% or 5%) on the energy ratio E_A/E_B between cavities. As already known [8], the damping of the plate has rather no influence on energy ratio below the critical frequency whereas an increase of damping of the plate is efficient above critical frequency to improve acoustic insulation of the panel.

This test case demonstrates that the non-resonant transmission of the plate is well represented by MODENA.

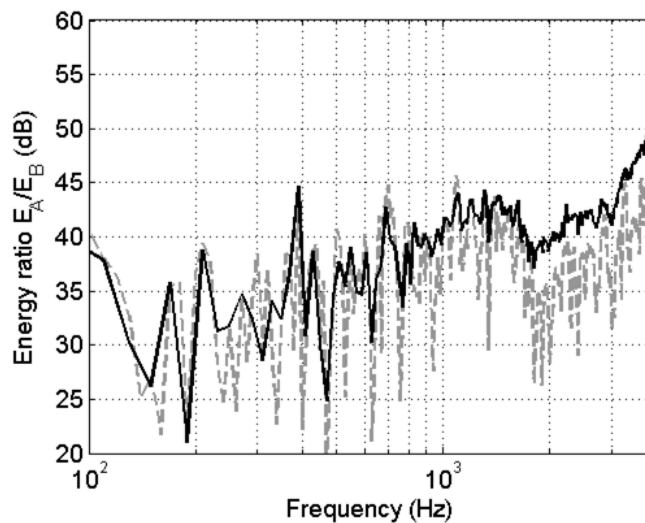

Figure 7: influence of damping of the plate on energy ratio between cavities. Solid black line: damping 1%; dashed gray line : damping 5%.

6. RIBBED PLATE/CAVITY TEST CASE

In previous example, an analytical solution for eigenmodes was used. In this example, a ribbed plate is modelled by finite element method and is coupled to an analytical model of cavity. In that case, a rectangular simply supported ribbed plate (15 stiffeners) is excited by a point force and radiates into an “analytical” cavity. The model of the plate is presented in figure 8. The eigenmodes of the plate have been computed up to 8,5kHz and the energy responses of the plate and the cavity have been computed from 10 to 8000Hz (frequency step 1Hz).

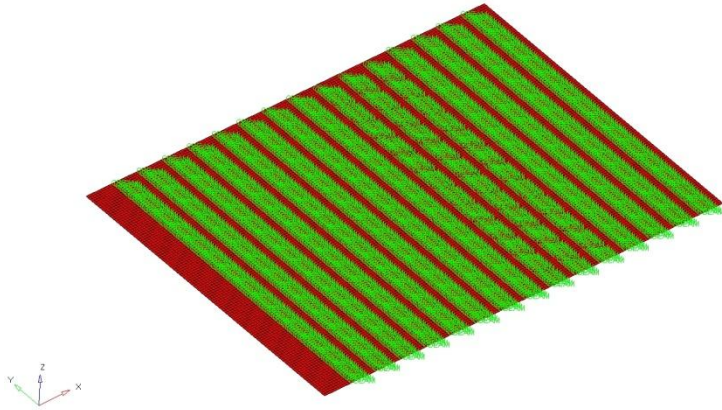

Figure 8. FE model of the ribbed plate.

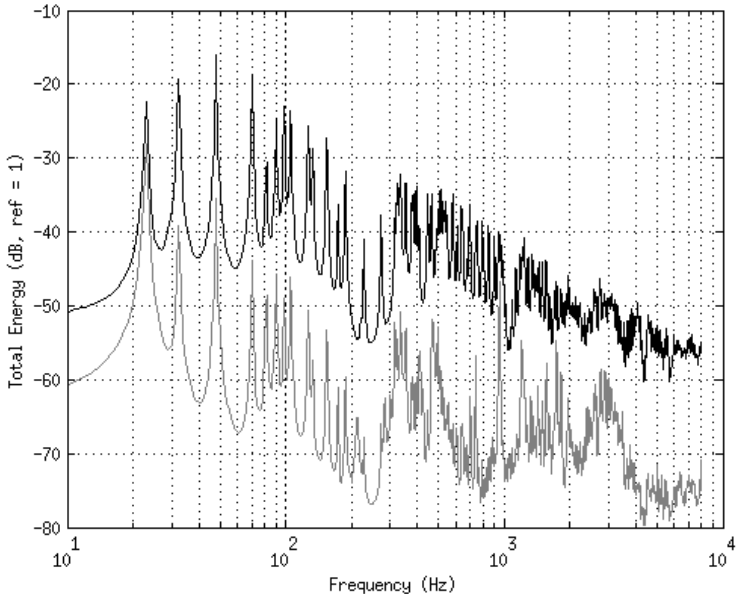

Figure 9. Total energies of the ribbed plate (black) and the cavity (gray) when the ribbed plate is excited by a point force.

As can be seen in figure 9, the energy frequency responses of subsystems can be computed up to high frequency using uncoupled modes of subsystems. In the present example, all the modes between 0 and 8500Hz have been used but more efficient strategy may be chosen to speed up calculations as already discussed (sliding sum on cavity modes for example).

7. CRITICAL GYROSCOPIC COUPLING

The pure tone coupling loss factor defined in equation (13) can be positive or negative. The limit between a positive or a negative value for $\alpha_{ij}(\omega)$ is driven by the denominator of equation (13). Indeed, three different zones can be defined:

- If $|H_{ii}(\omega)|^2 |H_{jj}(\omega)|^2 > |H_{ij}(\omega)|^2 |H_{ji}(\omega)|^2$, $\alpha_{ij}(\omega)$ is positive
- If $|H_{ii}(\omega)|^2 |H_{jj}(\omega)|^2 < |H_{ij}(\omega)|^2 |H_{ji}(\omega)|^2$, $\alpha_{ij}(\omega)$ is negative
- If $|H_{ii}(\omega)|^2 |H_{jj}(\omega)|^2 = |H_{ij}(\omega)|^2 |H_{ji}(\omega)|^2$, $\alpha_{ij}(\omega)$ tends to infinity (18)

Contrary to SEA, the power can flow from oscillator with the lowest energy to the one with the highest energy.

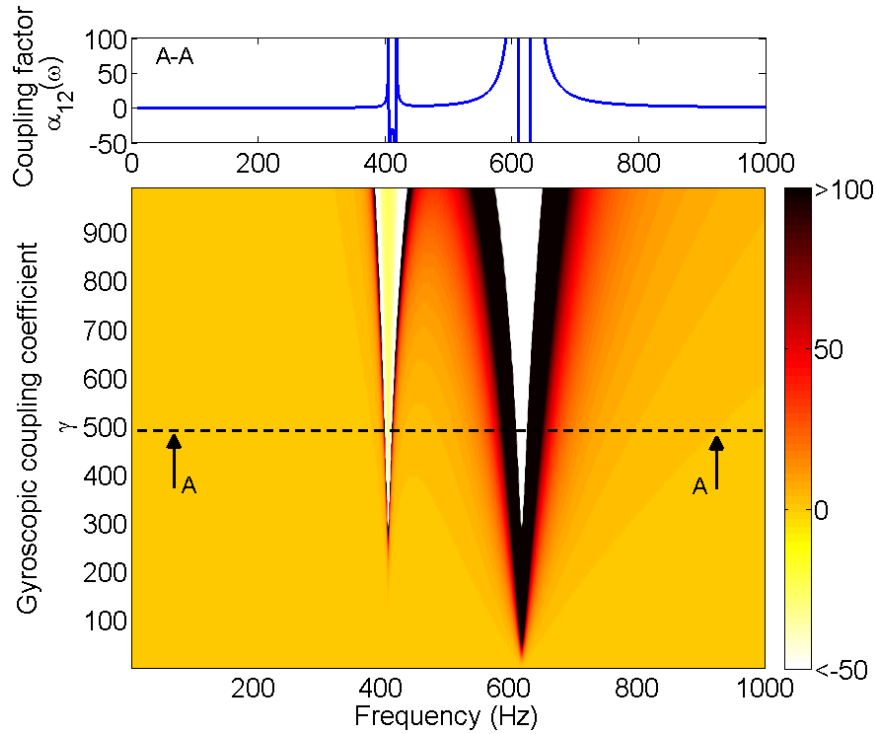

Figure 10. Pure tone coupling loss factor $\alpha_{ij}(\omega)$ as a function of frequency and gyroscopic coupling coefficient. The upper figure plots the coefficient for $\gamma=500$

Figure 10 demonstrates that $\alpha_{ij}(\omega)$ can be negative for approximately $\gamma > 300$ (in that case). Below this value, the behaviour is comparable to SEA. Above this value an “anti-thermodynamic” behaviour appears.

This limit can be expressed using condition (18). Thus a critical gyroscopic coupling coefficient can be defined as

$$\gamma_{ij}^{crit}(\omega) = \sqrt[4]{\left[\frac{(\omega_i^2 - \omega^2)^2}{\omega^2} + \Delta_i^2\right] \left[\frac{(\omega_j^2 - \omega^2)^2}{\omega^2} + \Delta_j^2\right]} \quad (19)$$

Figure 11 presents the evolution of the critical gyroscopic coupling coefficient as a function of frequency in the case of two coupled oscillators.

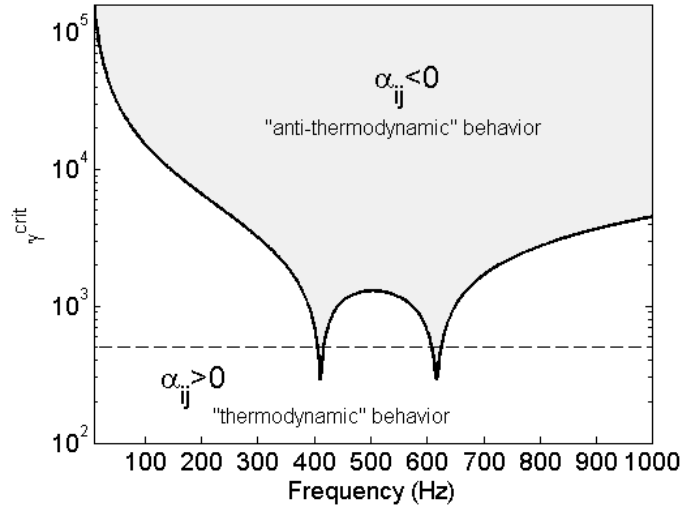

Figure 11: Critical gyroscopic coupling coefficient as a limit between positive and negative zones for $\alpha_{ij}(\omega)$

For a given value of γ (500 in figure 11), the coupling between modes can be considered as weak or strong depending on the frequency.

It is then possible to define a criterion on couple of modes. If

$$\gamma_{pq}^2 > (\gamma_{pq}^{crit})^2 \quad (20)$$

mode p of subsystem 1 and mode q of subsystem 2 can be considered as strongly coupled as in that case the power flows from the mode with the lowest energy to the mode with the highest energy.

This criterion can be computed whatever the complexity of subsystems. Indeed, γ_{pq}^{crit} only depends on eigen-frequencies of uncoupled subsystems and γ_{pq} is proportional to the modal work between modes as shown in equation (17).

Let's take the example of a plate coupled to a big cavity filled either with air or water. In the first case, the coupling between the plate and the cavity is usually considered to be a weak coupling whereas in the second case the coupling is strong (i.e. the presence of the fluid highly modifies the behaviour of the plate). This can be verified using criterion (20) for each couple of modes.

Figure 12 plots couples of modes that verify criterion (20) in the case of light (air) or heavy (water) fluid. Figure 12 demonstrates that, for three different frequencies (100Hz, 500Hz and 1000Hz), no couple of modes verify the criterion (20) in the case of light fluid (figures 12(a), 13(a) and 14(a)). Contrary, in case of heavy fluid, at each frequency, some couples of modes are strongly coupled and verify criterion (20).

At 100Hz (figure 12(b)), some resonant modes of the plate are strongly coupled to non resonant modes of the cavity (mostly high order modes).

At 500Hz (figure 13(b)), resonant modes of the cavity are strongly coupled to non resonant modes of the plate (mostly low order modes).

At 1000Hz (figure 14(b)), some resonant modes of the plate are strongly coupled to some resonant modes of the cavity and resonant modes of the cavity are strongly coupled to non resonant modes of the plates.

As a conclusion on the analysis of these figures, one can conclude that the particular effect observed when criterion (20) is fulfilled doesn't occur when a structure is coupled to a light fluid. In that case, the power always flows from the modes of the structures to the modes of the cavities (if only the structure is excited). Contrary, in case of heavy fluid, energy of modes of the cavity can be transmitted to modes of the structure even if they have lower values.

This phenomenon doesn't appear in SEA (or even in SmEdA) because of broad band excitation.

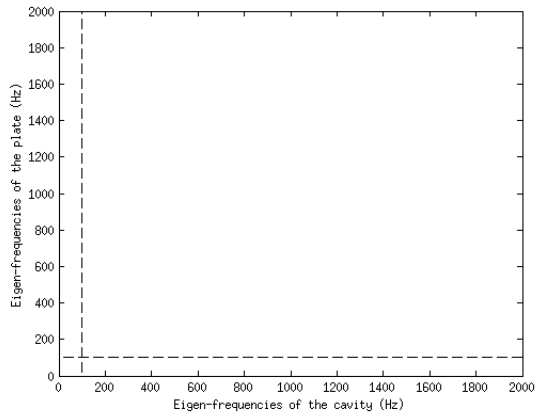

(a)

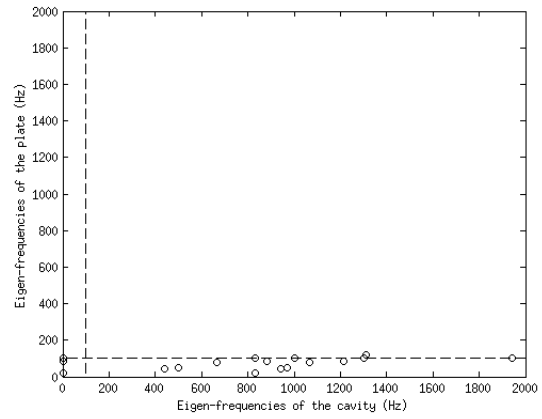

(b)

Figure 12. Couples of modes verifying strong coupling criterion (20). Cavity filled with air (a) or water (b). 100Hz

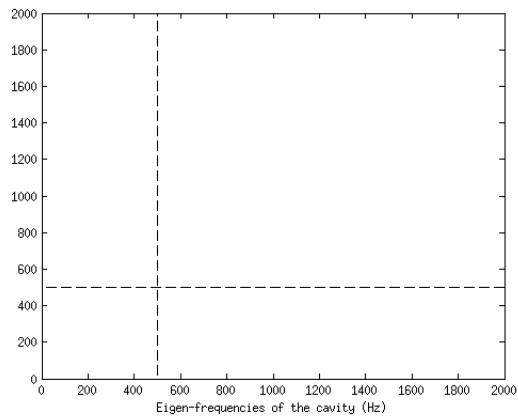

(a)

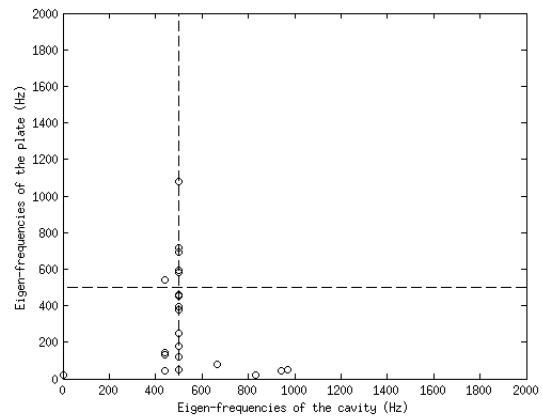

(b)

Figure 13. Couples of modes verifying strong coupling criterion (20). Cavity filled with air (a) or water (b). 500Hz

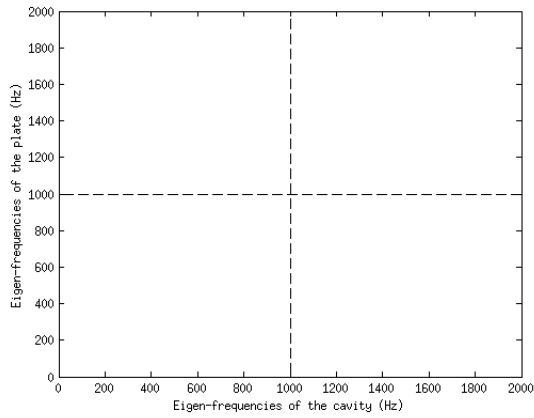

(a)

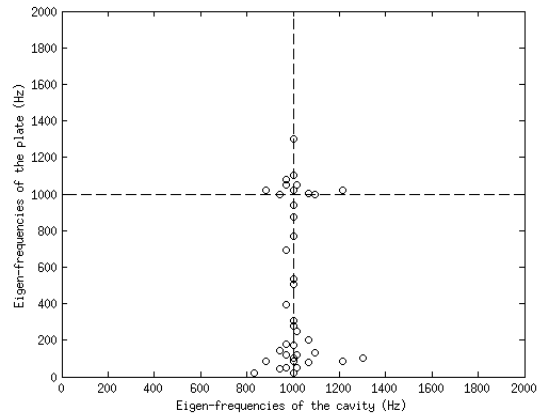

(b)

Figure 14. Couples of modes verifying strong coupling criterion (20). Cavity filled with air (a) or water (b). 1000Hz

CONCLUSION

The present paper deals with an energy method based on equations of motion of two coupled oscillators at pure tone. A power balance can be written between injected, dissipated and transmitted power. Extending this power balance to multi-modal subsystems, one can obtain a system of equations linking modal energies of subsystems at pure tone.

The approach has been validated in the case of Plate/Cavity and Cavity/Plate/Cavity coupling showing that this method is able to take into account non resonant transmission and can be applied to any kind of subsystems thank to FE models.

Finally, the pure tone modal coupling loss factor defined for this method can give information about the coupling strength between modes.

REFERENCES

- [1] M. J. Crocker, A. J. Price. Sound transmission using statistical energy analysis. *Journal of Sound and Vibration*, Vol. 9, 1969, pp. 469–486.
- [2] A. Le Bot, V. Cotoni, Validity diagrams of Statistical Energy Analysis, *Journal of Sound and Vibration*, 2010, Vol. 329(2), pp. 221-235.
- [3] L. Maxit, J.L. Guyader, Extension of SEA model to subsystem with non-uniform modal energy distribution, *Journal of Sound and Vibration*, 2003, Vol. 265, pp. 337-358.
- [4] N. Totaro, C. Dodard, J.L. Guyader, SEA coupling loss factors of complex vibro-acoustic systems, *Journal of Vibration and Acoustics*, 2009, Vol. 131, 041009-1.
- [5] L. Maxit, K. Ege, N. Totaro, J.L. Guyader, Extension of SmEdA (Statistical modal Energy distribution Analysis) to non-resonant transmission. *Proceedings of ICA 2013, Montréal, Canada, 2013*.
- [6] N. Totaro, J.L. Guyader, MODal ENergy Analysis, *Journal of Sound and Vibration*, 2013, <http://dx.doi.org/10.1016/j.jsv.2013.02.022>.
- [7] CDValor, a vibro-acoustic benchmark for simple structures, EA 27, INRS, 2006.
- [8] C. Cacciolati, P. Nèple, E. Guyader, J.L. Guyader, N. Totaro, Comparison of the vibroacoustic behavior of a rectangular thin plate excited by a diffuse sound field and a turbulent boundary layer. *Proceedings of ICSV13, Vienna, Austria, 2006*.