



**HAL**  
open science

## Optimal design of thermal storage tanks for multi-energy district boilers

Mouchira Labidi, Julien Eynard, Olivier Faugoux, Stéphane Grieu

► **To cite this version:**

Mouchira Labidi, Julien Eynard, Olivier Faugoux, Stéphane Grieu. Optimal design of thermal storage tanks for multi-energy district boilers. 4th Inverse Problems, Design and Optimization Symposium (IPDO-2013), Jun 2013, Albi, France. Thematic 5 - Optimal design and Global Optimization - n°04867. hal-00840709

**HAL Id: hal-00840709**

**<https://hal.science/hal-00840709v1>**

Submitted on 4 Jul 2013

**HAL** is a multi-disciplinary open access archive for the deposit and dissemination of scientific research documents, whether they are published or not. The documents may come from teaching and research institutions in France or abroad, or from public or private research centers.

L'archive ouverte pluridisciplinaire **HAL**, est destinée au dépôt et à la diffusion de documents scientifiques de niveau recherche, publiés ou non, émanant des établissements d'enseignement et de recherche français ou étrangers, des laboratoires publics ou privés.

## OPTIMAL DESIGN OF THERMAL STORAGE TANKS FOR MULTI-ENERGY DISTRICT BOILERS

**Mouchira Labidi<sup>a,b</sup>, Julien Eynard<sup>b,c</sup>, Olivier Faugeroux<sup>b,c</sup>, Stéphane Grieu<sup>b,c</sup>**

<sup>a</sup>Cylergie, L'Orée d'Écully, Bâtiment C, Chemin de la Forestière, 69130 Écully, France

<sup>b</sup>PROMES-CNRS, Rambla de la Thermodynamique, Tecnosud, 66100 Perpignan, France

<sup>c</sup>University of Perpignan Via Domitia, 52 Avenue Paul Alduy, 66860 Perpignan, France  
{[mouchira.labidi](mailto:mouchira.labidi); [julien.eynard](mailto:julien.eynard); [olivier.faugeroux](mailto:olivier.faugeroux); [stephane.grieu](mailto:stephane.grieu)}@promes.cnrs.fr

### Abstract

The present paper deals with optimizing a multi-energy district boiler by adding to the plant an optimally designed thermal water storage tank. First, an operation strategy is defined to manage the plant efficiently. Next, a reliable sizing method based on a parametric study is proposed. Various energy and economic criteria are evaluated for a range of thermal storage sizes. One can then choose a particular size that meets needs and expectations. Once the size of the storage tank is defined, a simulation program allows the assessment of its impact on the boiler units dynamics. The proposed methodology has been applied to many multi-energy district boilers managed by Cofely GDF-Suez, our industrial partner. In this paper, we present a case study: a district boiler situated in southwest France. The results we obtained highlight the ability of a thermal storage tank (optimally sized and managed) to improve the operation of a multi-energy district boiler and realize significant economic savings.

### Introduction

In order to meet the 20% renewable energy target by 2020, the European Union counts on biomass to impact on final heat energy consumption. Using biomass materials such as wood, in industrial and residential heating, can significantly reduce the reliance on fossil fuels and limit CO<sub>2</sub> emissions [1]. The UE commission's recent report on the sustainability of biomass affirmed that biomass for heating and power applications can reduce such emissions by 55 to 98%. In financial terms, biomass is also cheaper than many fossil fuels commonly used for heating, mainly gas and oil [2,3]. Furthermore, government financial incentives could improve the economic performance of heating using biomass energy. Today, this potential is only being realized at a slow pace. So, ambitious and flexible strategies are needed to increase the use of biomass in Europe [4].

Thermal energy storage is an attractive technology considered in several studies dealing with the optimal sizing of heat generating systems in CHP (Combined Heat and Power) [5,6,7,8] or solar heating plants [9,10]. Using this mature technology in multi-energy district boilers, which is a rational and efficient solution (more than domestic boilers) to provide heat to buildings, is an innovative approach. This approach can demonstrate its effectiveness as an alternative way to maximize the profits from wood exploitation (renewable energy) and thus reduce the use of gas (fossil energy). In multi-energy district boilers equipped with thermal storage systems, a part of the energy produced by the combustion of wood can be stored when demand is lower than production and released later when production is not sufficient to meet peak load needs. Thus, this kind of systems based on thermal stratification [11,12,13] is more than just a hot water cylinder and when it is properly managed, it enables biomass boilers to meet a greater proportion of the annual energy requirements. It is also likely to offer protection to the boilers and improve in a significant way the overall efficiency of a plant.

In France, this concept is still under development and the main question that arise is how the optimal size of a thermal storage tank in a district boiler can be found? In addition, in what way the whole system can be managed efficiently? The optimal sizing of a thermal storage system managed by a predictive controller has been demonstrated in a particular case (OptiEnR research project) [14,15,16]. The second phase of this project aims at simplifying and generalizing this approach to other collective boilers.

So, this paper focuses on carrying out a simple methodology to estimate and analyze the influence of a thermal storage tank on the performance of a multi-energy district boiler. It also deals with optimal sizing. The first section of the paper provides a detailed analysis of the proposed design methodology. In the second section, a management strategy for multi-energy district boilers (equipped or not with energy

storage systems) and based on operation modes is presented. Then, energy and economic criteria are considered as evaluation tools. Finally, both the proposed sizing methodology and the management strategy are applied to a case study: a district boiler situated in southwest France. The key results we obtained highlight that an optimally sized thermal water storage tank is able to reduce fossil energy consumption, what results in significant economic savings.

### Design (sizing) methodology

Taking a look at the state of the art about the design of thermal storage tanks, one can see that there are different approaches, more or less pertinent. From an industrial point of view, Australian engineers go for 50 liters per kW of fuel boiler power. In the UK, engineers tend to consider 10 to 20 liters per kW of fuel boiler power. Other commonly used approaches consist in minimizing the necessary thermal capacity using a segmental integral method based on the load graph of a boiler plant [17,18]. In addition, when there are several boiler units in a district plant, a load assignment program can be used to define an operating scheme or an operating mode for such a plant. George et al. [19] and Kirchmayer [20] proposed the principle of optimal load assignment and the theory of coordination of incremental fuel costs.

These general approaches allow defining an approximative size for the storage tank but it is not optimally designed. An inadequate design of a thermal storage tank can lead to several problems. Indeed, an oversized one is a non-profitable investment (costs are excessive) while an undersized one cannot be really efficient (impact on performance is low). In opposition, an optimally-sized thermal storage tank has enormous potential to improve effectiveness in using thermal equipment and economic large-scale substitution. So, before taking the decision to install such a system, an appropriate design (sizing) is required. That is why a reliable sizing method based on a parametric study is proposed.

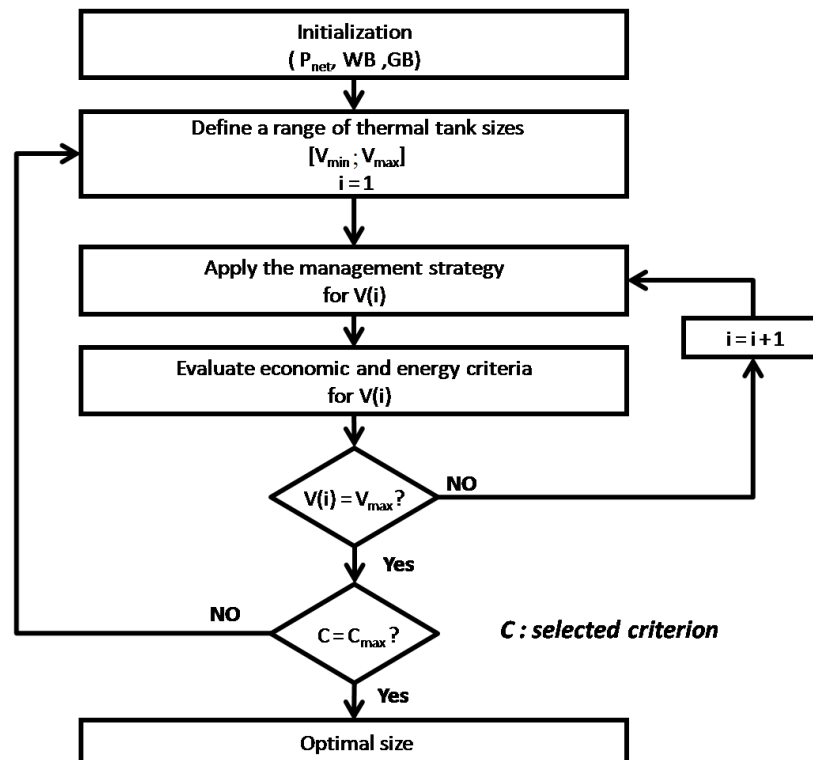

Fig. 1. Flowchart of the design (sizing) methodology.  $P_{net}$  is the heating network load, WB is the wood boiler and GB is the gas boiler

In multi-energy district boilers, biomass boilers (characterized by a minimal and a maximal heat production capacity  $[P_{min}; P_{max}]$ ), are generally sized to provide the most important part of the required

thermal energy but lack the capability of covering the peak loads [21]. So, auxiliary fossil boilers are needed to cope with load heat demand during the coldest periods of winter, a possible shut-down of biomass boilers for maintenance or if heat demand is lower than the minimal heat production.

The proposed methodology depicted by Figure 1 is based on 3 steps. First, a range of thermal storage sizes is defined according to the availability of space on site and finances. Then, a management strategy is applied to the district boiler equipped with the storage tank. At least, an economic and energy evaluation for each storage size is carried out to determine the feasibility of the proposed scheme for investment purposes. Based on the optimization of an economic or energy criterion, the optimal size of the thermal storage tank can be defined and the impact of such an investment can be evaluated.

The storage system has a total capacity  $E_{max}$  expressed by equation (1), with  $\rho$  ( $\text{kg/m}^3$ ) the water density,  $C_p$  the specific heat of water,  $\Delta T$  the difference of temperature between the cold and hot water and  $V$  the volume of the system ( $\text{m}^3$ ). Thermal losses are not considered here. The system is able to store the excess of energy generated by wood boilers and to release it instead of engaging fuel (gas) boilers.

$$E_{max} = \rho \cdot C_p \cdot V \cdot \Delta T \quad (1)$$

### Management strategy

The main purpose of this study is optimizing the operation of a multi-energy district boiler by adding an optimally-designed thermal storage tank and defining an adequate management strategy to be applied to the whole system. Due to the large variability in demand profiles and technical characteristics from one district boiler to another, thermal storage performances have to be evaluated case by case.

On the basis of load profiles ( $P_{net}$ ) and the wood boiler's characteristics, a multi-energy district boiler can be operated using an adequate strategy, as described by Figure 2 (left). Basically, the biomass power is modulated between  $P_{min}$  and  $P_{max}$  (S1) to meet energy requirements. When demand is lower than  $P_{min}$ , the wood boiler is switched off and the fuel (gas) boiler is used as sole heat generator (S3). During peak load periods, energy demand is shared between the wood boiler operating at its maximum power and the auxiliary gas boiler (S2). So, the main goal is to remove S3 and avoid switching to S2 using a thermal storage tank, both states leading to fossil energy consumption (Figure 2, right). Changes in demand and storage content ( $E_{cum}$ ) indicate when switching from one operation mode to another. 3 modes are proposed:

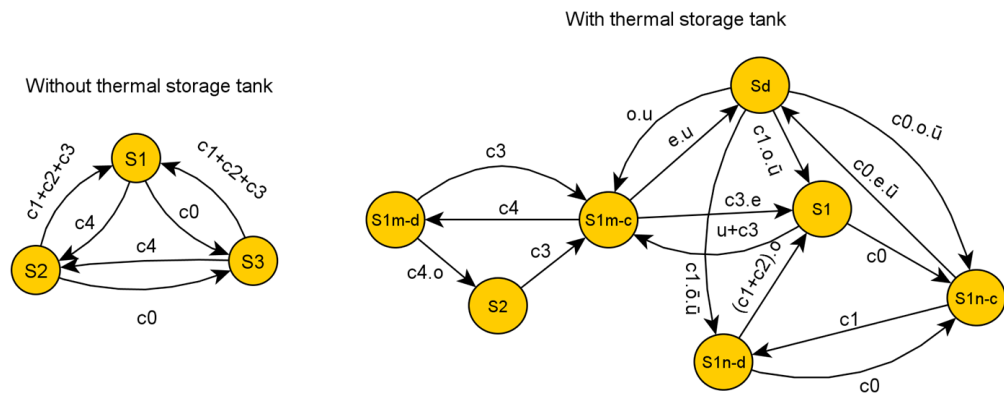

Fig. 2. State diagram of a multi-energy district boiler (with or without thermal energy storage)

**Operation mode 1.** During low-demand periods, instead of modulating the biomass power, the wood boiler operates at full load to meet energy requirements and charge the thermal storage tank. Once demand is upper than  $P_{WB}^{max}$ , the stored energy is used to satisfy excess demand. In this way, the gas boiler is only switched on when the storage tank is empty and demand still exceeds  $P_{WB}^{max}$ . This operation mode, represented by ( $S_1, S_2, S_{1m-c}, S_{1m-d}$ ), is generally used during winter periods characterized by an important energy demand.

**Operation mode 2.** This second mode is depicted by ( $S_1, S_2, S_{1m-c}, S_{1m-d}$ ) and considered during mid-season periods, when the energy demand is variable but does not exceed  $P_{WB}^{max}$ . When  $P_{net} < P_{WB}^{max}$ , instead

of stopping the wood boiler, we keep it running at minimal load and store the exceed of energy produced. It will be used later. In this way, this boiler is operating continuously and fuel energy can be saved.

**Operation mode 3.** During the hottest months of summer, most of the buildings do not need to be heated and, as a consequence, only domestic hot water is required. Generally, wood boilers are oversized to be able to operate during this period and a gas boiler is used to meet low power requirements. A wood boiler combined with a thermal storage tank can be used during the hottest months of summer as follows: first, the wood boiler operates at full load and allows both the heating network requirements to be met and the tank to be charged. Once the storage system is completely filled, the boiler is shut down and the stored energy is used to afford domestic hot water. The boiler is switched on again when the storage tank is empty. This operating mode, represented by ( $S_{In-c}$ ,  $S_d$ ), prevents the use of gas and favours the use of renewable energy. Table 1 summarizes the different states and transitions:

Table 1. Operation of a multi-energy district boiler

State	Action	Transition	Condition
$S_1$	$P_{WB} = P_{res} \ \& \ P_{GB} = 0 \ \& \ TS = 0$	$c_0$	$P_{net} < P_{min}$
$S_2$	$P_{WB} = P_{WB}^{max} \ \& \ P_{GB} = P_{res} - P_{WB}^{max} \ \& \ TS = 0$	$c_1$	$P_{min} \leq P_{net} < th_1$
$S_3$	$P_{WB} = 0 \ \& \ P_{GB} = P_{res} \ \& \ TS = 0$	$c_2$	$th_1 \leq P_{net} < th_2$
$S_{Im-c}$	$P_{WB} = P_{WB}^{max} \ \& \ TS = 1$	$c_3$	$th_2 \leq P_{net} < P_{max}$
$S_{Im-d}$	$P_{WB} = P_{WB}^{max} \ \& \ TS = -1$	$c_4$	$P_{net} > P_{max}$
$S_{In-c}$	$P_{WB} = P_{WB}^{min} \ \& \ TS = 1$	$o$	$E_{cum} = 0$
$S_{In-d}$	$P_{WB} = P_{WB}^{min} \ \& \ TS = -1$	$e$	$E_{cum} = E_{max}$
$S_d$	$P_{WB} = 0 \ \& \ TS = -1$	$u$	Summer period

### Energy and economic evaluation

Energy and economic criteria are proposed as performance indicators. Considering a wide range of thermal storage sizes, one can highlight the impact on a multi-energy district boiler operation thanks to these criteria. An adequate size can be chosen on the basis of the optimization of one or more criteria. As a key point and to address the question of the optimal capacity, what is expected from this system has to be highlighted. The basic purpose of thermal storage is to decrease gas consumption while ensuring the contractual wood coverage rate  $C_{wood-c}$ .  $E_{wood}$  and  $E_{gas}$  are the annual energy consumption from wood and fuel (gas), respectively (2):

$$C_{wood} = \frac{E_{wood}}{E_{wood} + E_{gas}} \quad (2)$$

Thermal water storage tanks gain their major economic advantage from the difference between the price of wood and fuel. So, a financial parameter  $Ec$  is defined as the annual economic gain associated to the use of a thermal storage tank (3).  $Ec_{gas}$  is the annual decrease in gas consumption (4) while  $OV_{wood}$  is the annual increase in wood consumption (5) due to the use of the tank.  $UP_{gas}$  and  $UP_{wood}$  are the prices per kWh of gas and wood, respectively. As mentioned above,  $E_{wood}$  and  $E_{gas}$  are the respective annual energy consumption from wood and fuel (in equations (4) and (5), with or without energy storage):

$$Ec = Ec_{gas} \times UP_{gas} - OV_{wood} \times UP_{wood} \quad (3)$$

$$Ec_{gas} = (E_{gas})_{no\ storage} - (E_{gas})_{storage} \quad (4)$$

$$Ec_{wood} = (E_{wood})_{storage} - (E_{wood})_{no\ storage} \quad (5)$$

In order to put in perspective the economic benefits related to energy savings, the payback period (PBP) has to be evaluated. The payback period is the length of time required to recover the cost of the

investment related to the thermal storage tank.  $PBP$  is calculated from  $C_s$ , an estimation of the thermal storage costs, and  $E_c$  (3). It is expressed as follows (6):

$$PBP = \frac{C_s}{E_c} \quad (6)$$

In addition, the economic gain  $G$  is calculated from  $PBP$  (6),  $E_c$  (3) and  $D_{op}$ .  $D_{op}$  is the operating period. It includes the effective operating time and all types of idle time, whether caused by maintenance and repair or by organizational or other reasons.  $G$  is expressed as follows (7):

$$G = (D_{op} - PBP) \times E_c \quad (7)$$

According to all of these considerations, the storage tank (related to its size) with the most important economic gain and that allows the contractual wood coverage rate to be satisfied is recommended as the optimal option. It should also be noted that new connections to the heating network, future building expansions as well as the way energy sale prices will evolve in the future are factors to be taken into account to evaluate accurately the limitations of the selected tank. Finally, the optimization problem can be formulated in the following way:

$$\max_V (G) \text{ with } \begin{cases} V \in [V_{\min}; V_{\max}] \\ C_{wood}(V) \geq C_{wood-c} \end{cases} \quad (8)$$

### Case study

This section of the paper focuses on a case study. Both the design methodology and the proposed management strategy are applied to a multi-energy district boiler situated in Midi-Pyrénées (France).

#### 1. Plant overview

Midi-Pyrénées is a region located in the southwest of France and renowned for its warm and pleasant climate throughout the year. The region boasts oceanic, mediterranean as well as continental weather influences. As a result, variability in the climate is high. With the Pyrenées mountains to its south, the Massif Central to the north, Midi-Pyrénées climate and weather are influenced from both sides. Thus, temperatures can be high during summer (average temperature is about 20°C) and quite low during winter (average temperature is about 6°C). There are also mild spring and autumn months.

The considered plant whose synoptic is shown in Figure3 is composed of three heat generators. The first generator is a biomass boiler WB [ $P_{WB}^{\min} = 1350 \text{ kW}$ ;  $P_{WB}^{\max} = 5400 \text{ kW}$ ] designed to ensure the base production. Since this wood boiler cannot operate beyond its upper or lower limit, a 3500 kW gas boiler (GB1) operates jointly with it during peak demand periods or alone when demand is lower than the wood boiler minimal power. A 6500 kW gas boiler (GB2) is only switched on in case of malfunction or during maintenance. The main objective of the work is to evaluate the impact on plant performance of an optimally designed thermal storage tank.

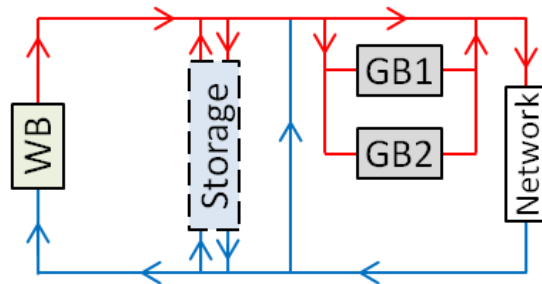

Fig.3. Synoptic of the considered multi-energy district boiler

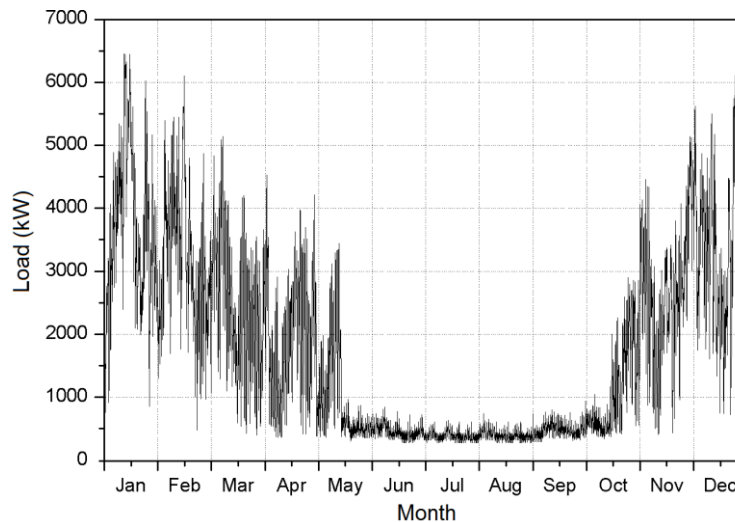

Fig.4. Heating network load (kW)

## 2. Operation modes

Taking into consideration the heating network load (Figure 4) as well as the generators characteristics provided by the plant operator (Cofely GDF-Suez), the management strategy discussed in section 1 can be applied to this multi-energy district boiler with  $th_1 = 2700$  kW and  $th_2 = 4050$  kW (Table 1). For this plant, two operation modes can be envisaged. During winter and mid-season periods (January, February, March, April, May (1-15), October (16-31), November, December), one can observe that the variability in energy demand is high. Sometimes it is lower than the minimal power of the biomass boiler (1350 kW) while it can exceed at times its maximum power (5400 kW). During summer (from May, 15 to October, 15), demand stabilizes at a power lower than 1000 kW.

First, let us consider the plant without storage tank. During the first period, the biomass power is modulated between 1350 and 5400 kW (S1) to meet demand. When requirements are out of this power range, the gas boiler is turned on (S2, S3). During this period, energy consumption of gas is evaluated at 0.720 MWh. This represents 4.67% of the annual energy demand. During the summer period, the wood boiler is not used and 10.64% of this annual demand is satisfied by the gas boiler (S3).

A thermal storage tank can be considered in order to reduce the annual gas consumption (estimated at 2.36 MWh, what represents 15.32 % of the annual energy demand). By storing and releasing energy, one can delay or even prevent the use of the gas boiler ( $S_{1m-c}$ ,  $S_{1m-d}$ ,  $S_{1n-c}$ ,  $S_{1n-d}$ ,  $S_d$ ).

## 3. Design (sizing) of the storage system and performance evaluation

A thermal storage system whose size varies from 0 to 1000 m<sup>3</sup> has been considered for the plant. Performance is evaluated thanks to the proposed energy and economic criteria. Figure 5 shows how wood and gas coverage rates evolve according to the volume of the system. First, one can highlight that the wood boiler is sized to insure around 85% of the annual energy demand. When adding to the plant a 100 m<sup>3</sup> thermal storage tank, the wood coverage rate increases of 13% (it is so equal to 98%). Beyond 100 m<sup>3</sup>, the volume of the tank impacts on the wood coverage rate in an insignificant way: if the volume of the tank increases 10 times, this rate increases only by 1.5%. This is without any doubts the consequence of a limited quantity of energy available to be stored.

Let us now investigate the economic impact of the proposed investment. Figure 6 shows that the optimal global gain is obtained when considering a 200 m<sup>3</sup> storage tank. Taking as a reference the district boiler without storage process, such a system allows 48.3 k€ to be saved annually. The cost of the investment related to the thermal storage tank is about 98 k€ and as a result it can be recovered in two years only. In addition, over the 25-year operating period, the global economic gain amounts to 1109.5 k€. Based on this assessment, one can confirm that adding to the plant a 200 m<sup>3</sup> thermal storage tank is commercially viable. However, an increase in demand or energy prices has to be taken into account to

complete the analysis. Regarding the ability of a 200 m<sup>3</sup> thermal storage tank to cope with an eventual increase in demand, one can observe (Figure 7) that the wood coverage rate remains higher than 90% (usually, the contractual wood coverage rate is 92%) in case of an increase in demand that does not exceed 40%. In addition, an annual increase in wood and gas prices of 1 and 2% respectively leads to a global economic gain of 1514.13 k€ over the 25-year operating period of the plant.

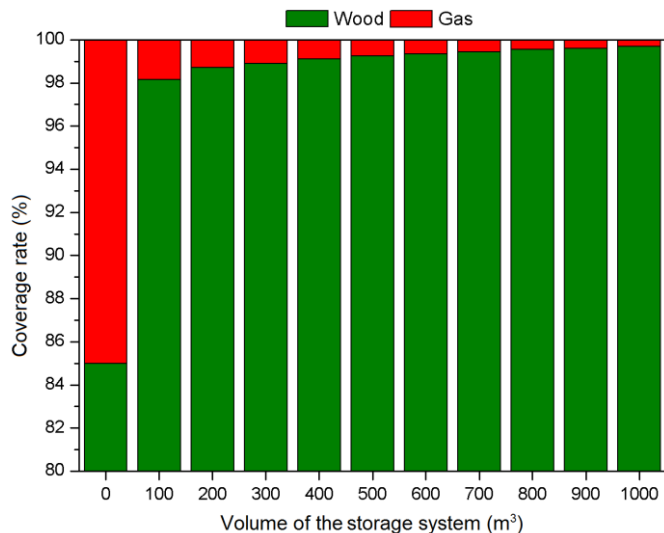

Fig.5. Impact of the volume of the storage system on the coverage rate

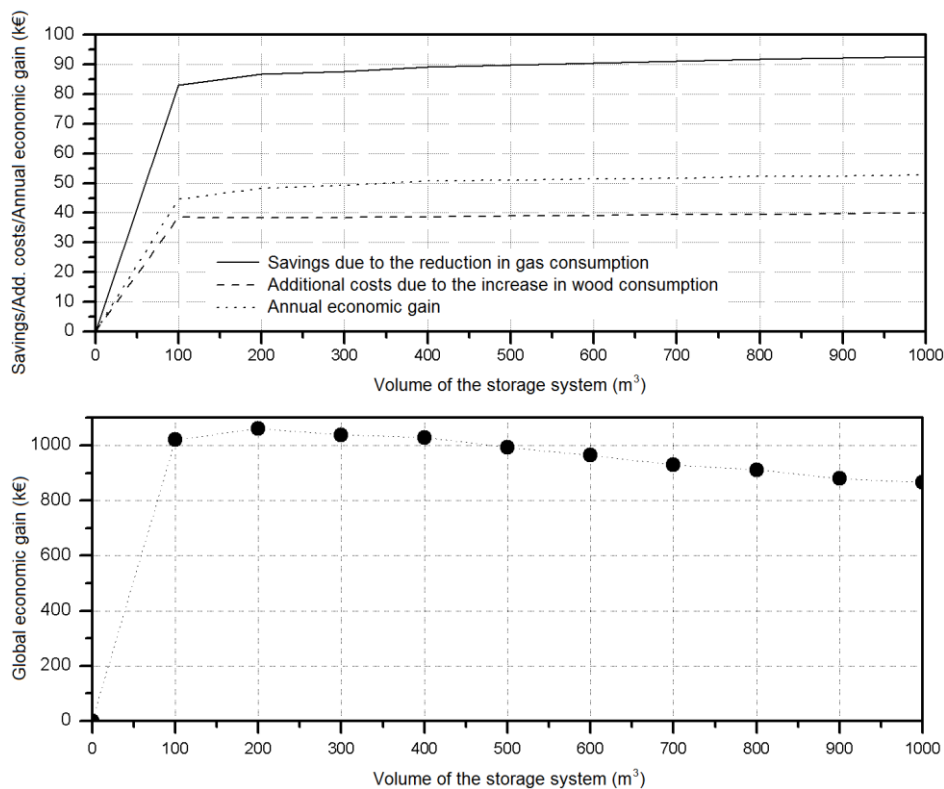

Fig.6. Economic evaluation of energy storage



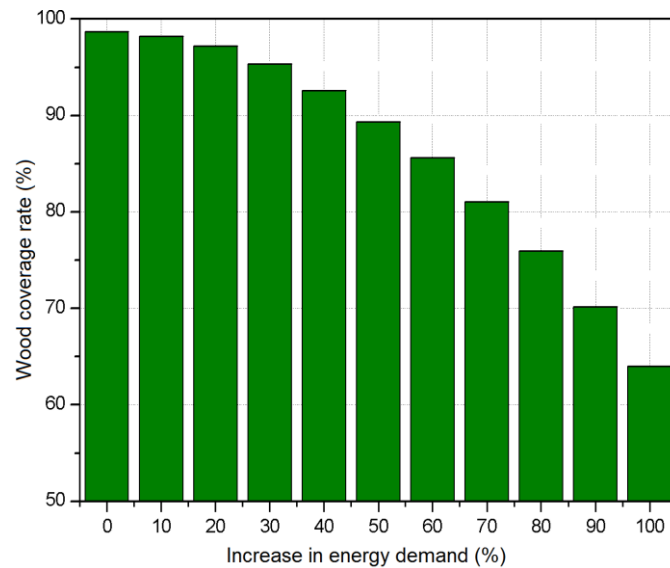

Fig.7. Impact on the wood coverage rate ( $C_{wood}$ ) of an increase in energy demand (the plant is equipped with a 200 m<sup>3</sup> thermal storage system)

Figures 8 and 9 show the behavior of the considered district boiler during the first week of January and the third week of May, respectively. During the first period (operation mode 1), the maximum load is 6.45 MW what means that the gas boiler will be used to cope with such a demand if the plant is not equipped with a thermal storage system. The minimum load is 0.27 MW and the gas boiler will also be used instead of the biomass boiler which is unable to meet a demand when it is lower than 1.35 MW. In opposition, when considering a 200 m<sup>3</sup> thermal storage system, the gas boiler is no more used during peak or low demand periods and the wood boiler operates continuously.

During the second period (operation mode 2), the maximum load is 0.760 MW what means that only the gas boiler can operate to satisfy energy requirements. The wood boiler, operating at its minimum power and combined with a 200 m<sup>3</sup> thermal storage tank, can replace the gas boiler and thus the amount of fuel energy consumed can be reduced. One can also observe that the storage system has a two-phase dynamics (charging /discharging), each one is about half a day. During the charging phase, the excess of energy produced by the wood boiler is stored and once the storage system is full, the wood boiler is shut-down and the demand in energy is satisfied only by the stored energy release.

## Conclusion

In this paper, an efficient methodology allowing the optimal volume of a thermal storage tank to be highlighted is presented. First, a parametric study is carried out to maximize the economic gain related to energy storage over the operating period of a multi-energy district boiler. As a key point, the contractual wood coverage rate has to be satisfied. Jointly to an efficient management strategy, an optimally designed thermal storage tank allows gas consumption to be reduced and the plant operation to be improved. Table 2 summarizes the results we obtained by applying the proposed approach to a case study. Future work will first focus on evaluating the thermal losses in the storage tank. In addition, a predictive control strategy will be applied to multi-energy district boilers.

Table 2. Main results (case study)

Configuration	$C_{wood}$	$Ec$	$G$ [25 years]	$PBP$
No storage system	85%	-	-	-
200 m <sup>3</sup> storage system	98.7%	48.3 k€	1109.5 k€	2 years

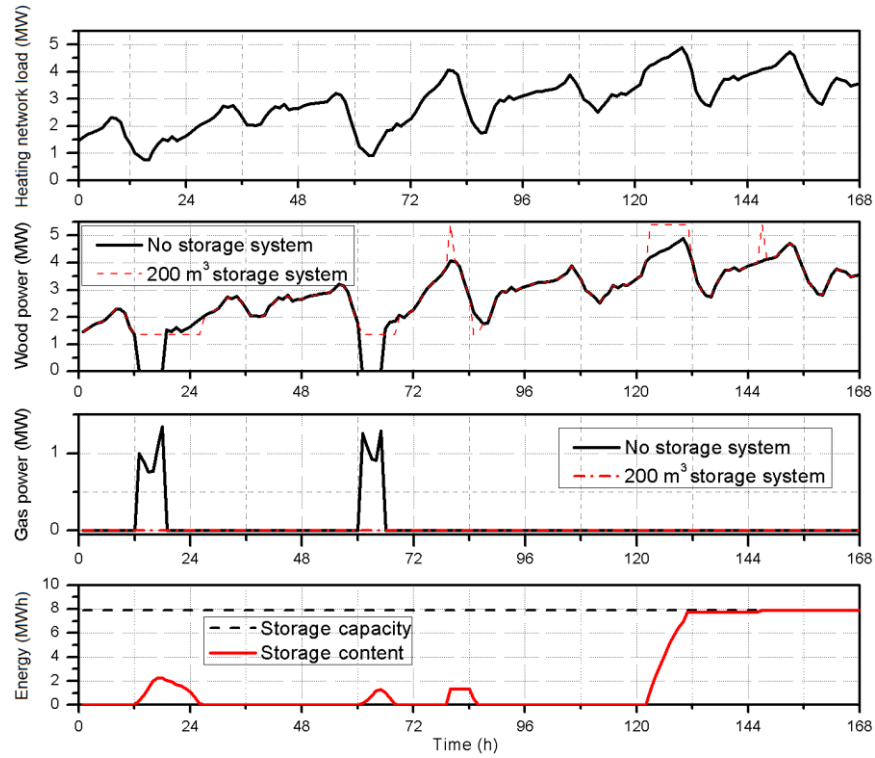

Fig.8. Plant's operation during January

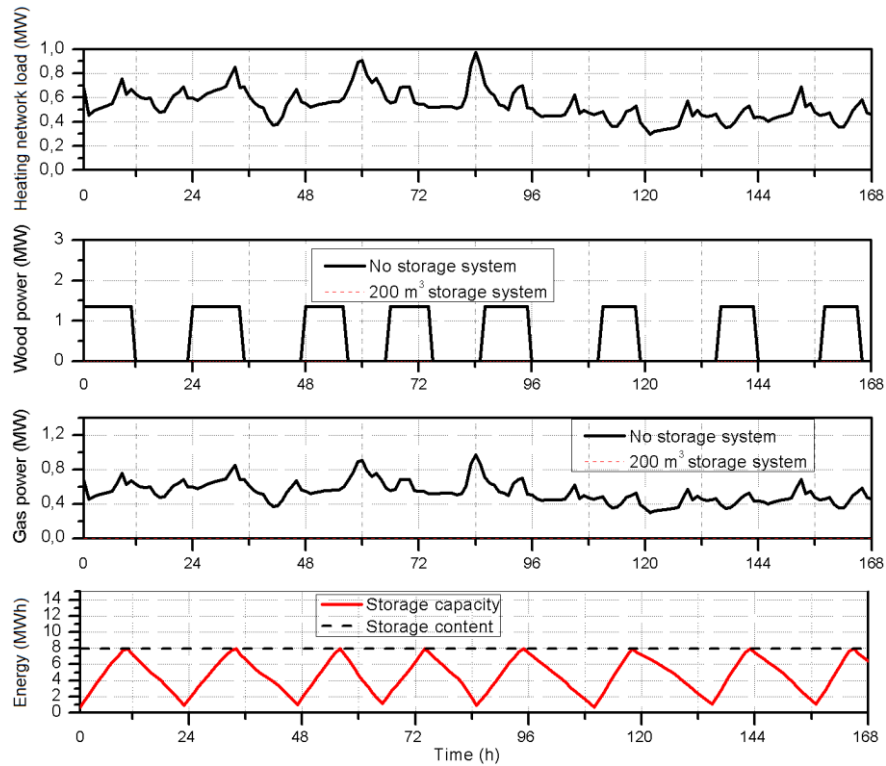

Fig.9. Plant's operation during May

## References

1. L.Kitzing, C. Mitchell and P.E. Morthorst, *Renewable energy policies in Europe: Converging or diverging?*, Energy Policy 51 (2012) 192-201.
2. J. Chau, T. Sowlati, S. Sokhansanj, F. Preto, S. Melin and X. Bi, *Technico-economic analysis of wood biomass boilers for the greenhouse industry*, Applied Energy 86 (3) (2009) 364-371.
3. P. Lauri, A.M.I. Kallio and U.A. Schneider, *Price of CO<sub>2</sub> emissions and use of wood in Europe*, Forst Policy and Economics 15 (2012) 123-131.
4. C. Klessmann, A. Held, M. Rathmann and M. Ragwitz, *Status and perspectives of renewable energy policy and deployment in the European Union. What is needed to reach the 2020 targets?*, Energy Policy 39 (12) (2011) 7637-7657.
5. S.I. Gustafsson and B.G. Karlsson, *Heat accumulators in CHP networks*, Energy conversion and Management 33 (12) (1992) 1051-1061.
6. V. Verda and F. Colella, *Primary energy savings through thermal storage in district heating networks*, Energy 36 (7) (2011) 4278-4286.
7. G. Taljan, G. Verbic, M. Pantos, M. Sakulin and L. Fickert, *Optimal sizing of biomass-fired organic rankine cycle CHP system with heat storage*, Renewable Energy 41 29-38.
8. A.D. Smith, P.J. Mango and N. Fumo, *Benefits of thermal energy storage option combined with CHP system for different commercial building types*, Sustainable Energy Technologies and Assessments 1 (2013) 3-12.
9. D. Bauer, R. Marx, J. Nubicker-Lux, F. Ochs, W. Heidemann and H. Müller-Steinhagen, *German central solar heating plants with seasonal heat storage*, Solar Energy 84 (4) (2010) 612-623.
10. T. Kozai, K. Shida and I. Watanabe, *Thermal performance of a solar greenhouse with water tanks for heat storage and heat exchange*, Journal of Agricultural Engineering Research 33 (2) (1986) 141-153.
11. V. Badescu, *Optimal operation of thermal energy storage units based on stratified and fully mixed water tanks*, Applied Thermal Engineering 24 (14-15) (2004) 2101-2116.
12. Y. Han, R. Wang and Y. Dai, *Thermal stratification within the water tank*, Renewable and Sustainable Energy Reviews 13 (5) (2009) 1014-1026.
13. R.M. Dickinson, C.A. Cruickshank and S.J. Harrison, *Charge and discharge strategies for a multi-tank thermal energy storage*, Applied Energy (2013), <http://dx.doi.org/10.1016/j.apenergy.2012.11.032>.
14. J. Eynard, *Gestion optimale de l'énergie dans un procédé multisource pour le chauffage de bâtiments*, Ph.D. thesis, Université de Perpignan Via Domitia, 2010.
15. J. Eynard, S. Grieu and M. Polit, *Optimal control of a multi-energy district boiler: a case study*, 18th International World Congress of the International Federation of Automatic Control, Milano, Italy, 2011.
16. J. Eynard, S. Grieu and M. Polit, *Predictive control and thermal energy storage for optimizing a multi-energy district boiler*, Journal of Process Control 22 (7) (2012) 1246-1255.
17. M. Cao and J. Cao, *Optimal design of thermal-energy stores for boiler plants*, Applied Energy 83 (2006) 55-68.
18. J. Cao, *Optimization of thermal storage based on the load graph of the thermal-energy system*, International Journal of Applied Thermodynamics 3 (2) (2000) 91-97.
19. E.E. George, H.W. Page and J.B. Ward, *Coordination of fuel costs and transmission loss by use of the network analyzer to determine plat-loading schedules*, AIEE Transactions 68 (1949) 1152-1163.
20. L.K. Kirchmayer, *Economic operation of power systems*, New York: John Wiley & Sons, Inc (1958) 11-17.
21. I. Vallios, T. Tsoutsos and G. Papadakis, *Design of biomass district heating systems*, Biomass and Bioenergy 33 (4) (2009) 659-678.