



HAL
open science

Investigations on electromagnetic noises and interactions in electronic architectures : a tutorial case on a mobile system

Jean-Marc Dienot

► **To cite this version:**

Jean-Marc Dienot. Investigations on electromagnetic noises and interactions in electronic architectures : a tutorial case on a mobile system. Mediterranean Telecommunications Journal, 2012. hal-00840346

HAL Id: hal-00840346

<https://hal.science/hal-00840346v1>

Submitted on 2 Jul 2013

HAL is a multi-disciplinary open access archive for the deposit and dissemination of scientific research documents, whether they are published or not. The documents may come from teaching and research institutions in France or abroad, or from public or private research centers.

L'archive ouverte pluridisciplinaire **HAL**, est destinée au dépôt et à la diffusion de documents scientifiques de niveau recherche, publiés ou non, émanant des établissements d'enseignement et de recherche français ou étrangers, des laboratoires publics ou privés.



Open Archive Toulouse Archive Ouverte (OATAO)

OATAO is an open access repository that collects the work of Toulouse researchers and makes it freely available over the web where possible.

This is an author-deposited version published in: <http://oatao.univ-toulouse.fr/>
Eprints ID: 8331

To link to this article: <http://www.rmt.univcasa.ma/RMT4.pdf>

To cite this version:

Dienot, Jean-Marc *Investigations on electromagnetic noises and interactions in electronic architectures : a tutorial case on a mobile system.* (2012)
Mediterranean Telecommunications Journal .

Any correspondence concerning this service should be sent to the repository administrator:
staff-oatao@inp-toulouse.fr

INVESTIGATIONS ON ELECTROMAGNETIC NOISES AND INTERACTIONS IN ELECTRONIC ARCHITECTURES: A TUTORIAL CASE ON A MOBILE SYSTEM

Jean-Marc DIENOT
University P. Sabatier, France
jm.dienot@iut-tarbes.fr

Abstract: Electromagnetic interactions become critic in embedded and smart electronic structures. The increase of electronic performances confined in a finite volume or support for mobile applications defines new electromagnetic environment and compatibility configurations (EMC). With canonical demonstrators developed for tutorials and EMC experiences, this paper present basic principles and experimental techniques to investigate and control these severe interferences. Some issues are reviewed to present actual and future scientific challenges for EMC at electronic circuit level.

Keywords: *Electromagnetic Compatibility, Emission, Coupling, Susceptibility, Immunity, Noise, Aggression, Embedded, Chip, Printed Circuit Board (PCB), Wire, Packaging, Near-field, TEM.*

1 INTRODUCTION TO THE EMI DOMAIN

1.1 The EMC merging and issues

The domain of the Electromagnetic Compatibility (EMC) still keeps a confidential view in its real and practical use, even if the term has continuously enforced the minds in the electronics approach since 1996. From this date, a focus on EMC has merged due to official Regulations and Standardizations announcements, for major electronic systems to be on the European and International market [1]. Industrials designers and providers first have been seriously alerted on the lack of information and solutions to respond to Electromagnetic Interferences (EMI) standardization to comply their products [2]. In fact, the electronic parasitic, interferences, electromagnetic noises and couplings have always been a problem, either due by natural sources (thunderbolt, earth or cosmic radiations) or by artificial sources initiated by the start and progress in the control of electric energy for human activities. But with continuous progress in technology of electronics, whereas performances are boosted in speed, frequency bandwidth, integration densities, and energy efficiency, the electromagnetic coupling's conditions and cohabitations have been enforced in all categories of electronic levels and applications[3]. The term "Compatibility" has been associated at "Electromagnetic" since the 1950-1960 years, with the Silicon Transistor revolution illustrated by the "Moore Law": frequency and number of transistor should increase exponentially each year. The EMC philosophy is dedicated to optimize the best nominal behavior of electronics, in presence of different electromagnetic

environment. In 1996, it was difficult to give instantaneous and useful responses to different actors suddenly concerned by this problematic: industrials for the standard's application, engineers and searchers for good conception, students, technicians to validate investigations and measurements. Scientific, technical and theoretical efforts in these ways have been initiated and has generated nowadays a formal scientific and professional community in EMC domain [4][5][6]. Three fundamental principles are the base to consider intellectual and practical approach of EMC studies [7]:

1 - Electromagnetic interferences and couplings are determinist origin, and can have some physicals and electronically explanations to highlight.

2 -The EM problems appear in the real normal and nominal modes of systems and devices. So the closed and global environment has to be considered as a main contributor.

3 -EMC view and approach is a very good scientific exercise that can reflect the understanding, the design and the conception quality of any electronic architecture.

1.2 The EMC investigation methodology

To start an EMC investigation challenge, among the complexity of a device, studies must be driven with three fundamental dedicated formalisms [3][6][8]:

1: An electronic device or system can be considered as a **source**. The source is the term that qualifies the device as a voluntary or involuntary (parasitic) generator of signals and excitations. An electronic device or system can be also considered as a **victim**, that qualifies the device to present unwanted and disturbing reactions to voluntary or involuntary signals arriving to its different access. Between the source and the victim, the key term is the **coupling** or **link** mode. This one is not wanted or designed for, but can be identified either with wired or wireless configuration, or both.

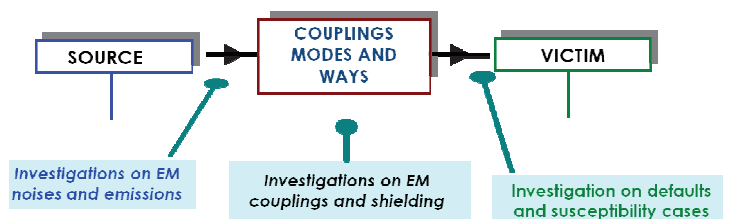

Fig. 1: The first EMC formalism

In the first case, the conductive connections and transmission line characteristics: characteristic impedance, electrical length, have to be considered. In the second case, the electromagnetic and physical characteristics: materials, permittivity ϵ , permeability μ , distance, near-field, far field have to be considered.

2: If a system is considered as a source, **emission** is the key term of its characteristics [3][6][12]. Emission levels are presented with the power in Watts (W) or in Decibel (dB), or usually in alternative reference to 1mW: dBm = 10 log (P/1mW). If the impedance of the receiver or wave is known, emissions can also be represented with the derivative physical values:

EMC physical value	Symbol	Unity	Associate Unity
Voltage	U or V	Volts(V)	dB _V : 20*log(V) dB _{μV} : 20*log(V/10 ⁻⁶)
Current	I	Ampere(A)	dB _A : 20*log(I) dB _{nA} : 20*log(I/10 ⁻⁹)
Electric Field	E	Volt by meter(V/m)	dB _{V/m} : 20*log(E) dB _{μV/m} : 20*log(E/10 ⁻⁶)
Magnetic Field	H	Ampere by meter(A/m)	dB _{A/m} : 20*log(H) dB _{nA/m} : 20*log(H/10 ⁻⁹)

Tab. 1: The second EMC formalism: physical values for EMC representation

The emission figure give information on electromagnetic noise repartition over a range of frequency. Then, the emission margins can be defined by a shift in dB over the maximums peaks of the real emission diagram.

If a system is considered as a victim, **susceptibility** and **immunity** are the key terms for characterizing the sensitivity of device to electromagnetic aggression. Susceptibility is the physical reaction to an aggression. Immunity is the ability of the device to stay insensible to one or multiple aggressions with a certain margin over the real reaction of the device. The figure of susceptibility/immunity is derived by placing the levels of aggression that generate a default or dysfunction, among the equivalent frequency bandwidth.

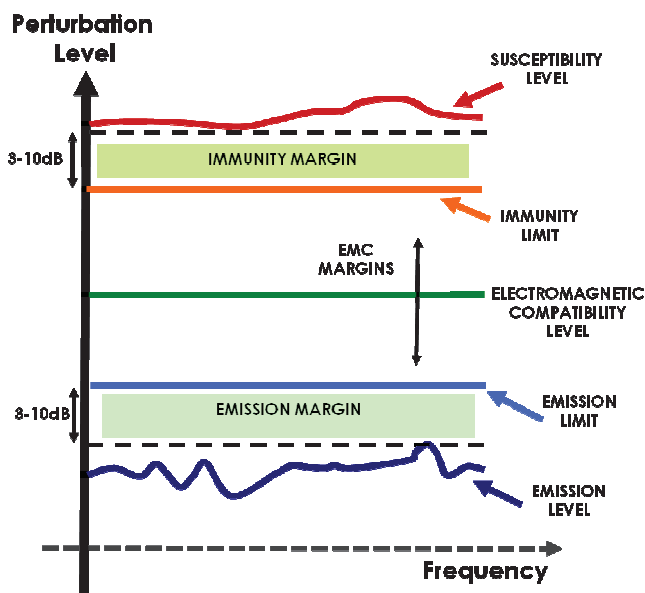

Fig. 2: The second EMC formalism: emission, immunity and EMC margins

3: conducted and radiated modes[3][6][12]: the dynamic behavior in electronics and the equivalent wavelength rely to the notion of conducted and radiated modes. Some basic physical assumptions, derived from Maxwell equations, resume that:

a voltage(V) generates an Electric Field(V/m) and vice versa

a current (A) generates a magnetic field (A/m) and vice versa.

The fundamental key of these generations is the wavelength, depending of the frequency and the speed of electromagnetic waves:

$$v = \lambda * f \quad \text{Eq. 1}$$

With v: electromagnetic wave speed, in meter/second

λ : Wavelength in meter

f: frequency in Hertz

Thus the equivalent electric length is approximated by the ratio of $\lambda/10$. If a conductive structure or device has dimensions under this value, the mode of coupling or propagation is considered as mainly conductive and quasi-static. If a conductive structure or device has dimensions over $\lambda/10$, the mode of coupling is considered as mainly radiated and propagative. An efficient configuration of radiated power is considered for dimensions of $\lambda/4$. In the case of radiated mode, the approximated number $\lambda / (2\pi)$ give the distance or the radius from the source to outside, that is called the near-field/far-field frontier(NFF).

In the near-field radiated mode, the electromagnetic field is localized by its sources, and is either most magnetic most electric. The impedance wave: $Z_w = \frac{E}{H}$ in ohms, vary among the distance or radius from the source.

In the far-field radiated mode: the source is considered as punctual, the impedance wave Z_w is constant. For remind, in the air, far-field impedance is about $Z_w = 377$ Ohms.

To resume, frequency is a key factor for distinguish different modes of couplings and propagation of perturbations and EM signals. EMC engineers and developers, and state of the standards give a technical repartition of these modes:

Frequency Range	Equivalent Wavelength (min)	NF frontier	Denomination and main EMC characteristics
0-9 kHz	33.3 km	5.3 km	Conducted Very low frequency (Electricity Mains)
9-150 kHz	2 km	318 m	Conducted Low frequency
150kHz-30 MHz	200 m	1.59 m	Conducted, High Speed Radiated Magnetic or Electric quasi static fields
30-300 MHz	1 m	15.9 cm	Conducted, very high speed Radiated near-field Radiated (RF)
300 MHz-3 GHz	10 cm	1.59 cm	Radiated RF and μ waves
3 GHz-30 GHz	1 cm	0.159 cm	Radiated High frequency waves

Tab. 2: The 3rd formalism: EMC frequency range of investigation

1.3 The EM environment of electronics architectures

Since 30 years, electronic architectures and applications are diffused in all sectors of public and daily life: Mobile phones, Portable Electronic Devices (PED), public and personal network, Wireless and Power Line Current (PLC) Communication technology, Electronics in Car for security and comfort, Smart Mobile systems (personal robots), etc... This development leads to increase electromagnetic pollution and electromagnetic field's interactions outside and inside system [13][14][17]. Independently of the necessary EMC standardization to provide compliant products on commercial and public market, the physical risk of different couplings scenarios and default in system is increasing. EMC studies have to be led to different parts among the sizes and the "bricks" constituting a system.

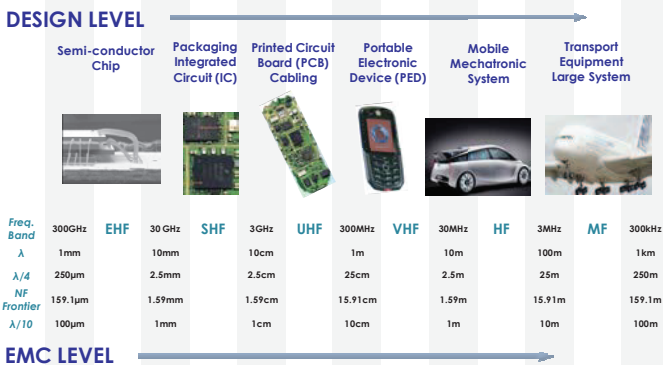

Tab. 3: EMC levels of investigations on electronics

EMC has become critical at Printed Circuit Board (PCB) and semiconductor integrated chips levels [8][9][12]. These parts actually are the main contributors of EMC sources and victims. We have to deal with more complex active chip's technology and design. The increase of performances: high-bandwidth, high speed switching time, low power consumption is a major cause of arise of EM interactions [10][13].

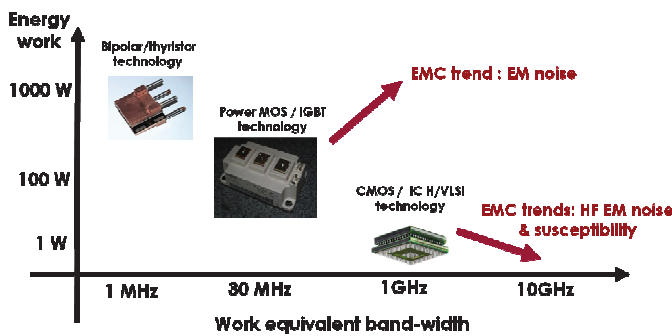

Fig. 3: EMC trends of electronic technologies

The packaging and PCB are the interfaces and supports from active devices and their loads or function. The complexity and density of integration of these structures generate also new complex EM configurations that radiate or receive more efficiency disturbances. If a perturbation generated in these structures or coming from outside have large wavelength, the main behavior of PCB is considered

as conducted. The major part of EMC consideration is the common mode disturbance that unfortunately benefit of numerous actual non-ideal common mode connections and packaging. For others cases, wavelengths are mainly in the same dimension as actual PCB and connections, that define them as radiator sources or victim [14].

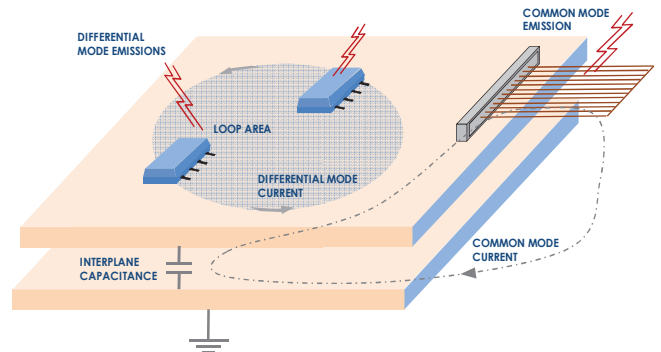

Fig. 4: Synthesize of EMC behaviors on PCB

2 EMI IN MOBILE ELECTRONICS ARCHITECTURES

2.1 Definition of a mobile/embedded system

Electronic has acquired new challenges since the notion of embedded systems leads to new kind of applications and innovations. A definition of embedded/mobile system:

"A mobile or transport system using a range of limited electrical and electronic functions to realize one or more tasks with autonomous and robust conditions". At circuit level, this concept derives new constraints for designers to trend to compliances issues [15][17]:

- Precise and critical choice of technology of circuits and sub-systems optimized to keep performances
- Physical constraints as inter-connections of subsystems, reduced volumes and weight, optimized dimensions.
- Electrical energy that is limited in the time and electronic informations that have to be operational in all conditions.

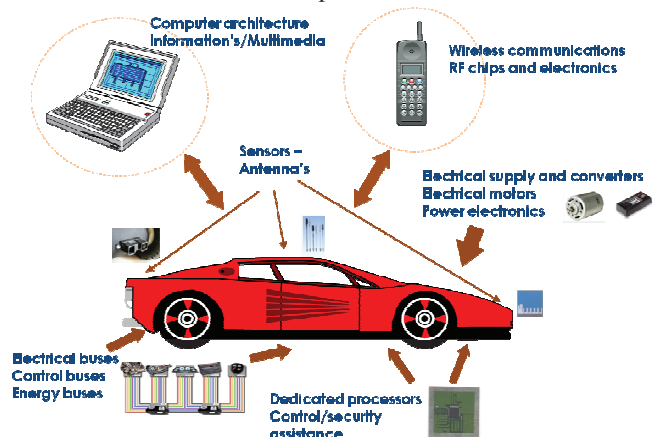

Fig. 5: The different electronics' functions in a Mobile/Embedded system

Consequently, it's the main point of view of this paper: Electromagnetic interactions and compatibility have also new views and approaches for investigations. The notion of electromagnetic risk is enforced with these applications, and the EMC solutions to prevent them must be adapted to these specific constraints, for example:

- Avoid shielding or protections devices that complexes the system
- Find the EM compliances that stay valid in function mobile conditions and in time
- Find EM protection solution that can be versatile (software's protection)

2.2 Description of demonstrator prototype for EMC investigations

We present a family of mobile system demonstrators for EMC investigations, used both for tutorial and research studies in the plat-form Labceem [54]. The objective is to investigate and analyze main external and internal EM disturbances that can affect an autonomous electric system. It consists of motorized autonomous small systems that use and mix different electronic technology. These prototypes are used as a view demonstrators of technology and designing principles for electric motion. For this tutorial, we focus on demonstrator ROB-CEM I, of dimensions about 24cmx35cmx35cm, realized on a wooden support for weight and EM considerations. It combines different elementary electronic techniques used for the controlled electrical motion [16]: Brushless and continuous current controlled, Power PCB with MOS/IGBT transistors and integrated drivers, command/control PCB with high-speed CMOS transistors and memory or FPGA technology, sensors for speed and position control, optional Wireless control and command. The motion and trajectory of the mobile system is controlled by the speed of each wheels. Two commands, PWM01 and PWM00, can be adjusted independently to drive a current in each motor. The cyclic rate of a PWM pattern generates an equivalent mean current, with a range of positive to negative value. So a combination of different movements can be programmed by different negative: positive speed of each wheel.

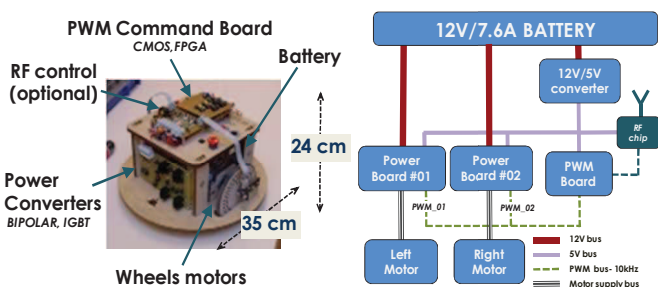

Fig. 6: Description of demonstrator ROB-CEM I

2.3 Emissions of the global mobile system

For starting the EMC point of view with the emission of the system, the investigation of EM noises and levels of the system consist in three steps:

- Place the system in nominal function
- Use an adequate emission sensor or antenna
- Use a receiver or spectrum analyzer that gives the representative distribution of emission levels on frequency bands

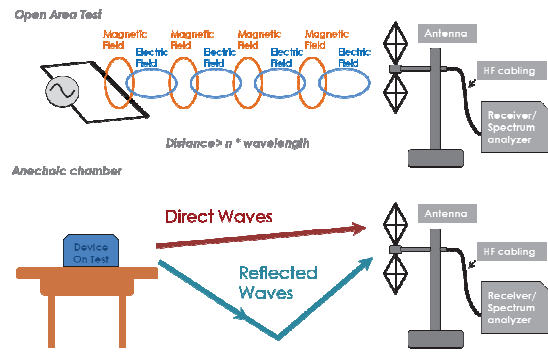

Fig. 7: Typical radiated electromagnetic field measurement setup on electronic devices and equipment

But, as the global noise of a complex system can be qualitatively very wide-band and not obviously ranged, this experiment is not yet always convenient. A first step is to identify main fundamental frequency of the functional system, and some harmonics at the ten or higher rank. For our system, we have for example a fundamental frequency of $f_0=10$ kHz, and harmonics distributed until 150 kHz, that allows to think to main conducted emissions and weak near-field only radiated emissions. But combination of all electronics parts and they different switching's rate leads to a non negligible wide band equivalent noise. Switching rate of electronic chips and components are in the range of $1\mu s$ to 1 ns, that leads to have equivalent frequencies range from MHz to GHz. So we can attend that the emission peaks and levels are mixed with EM ambient noise, especially in the same band of normalized radio frequency as FM (100 MHz), VHF, UHF, Mobile phone and others. The characterization must be conducted in shielded space, with the use of Faraday or anechoic chambers. For investigation at small device, circuits and planar configurations, an alternative exists to these expensive and complex solutions: shielded TEM mode antenna or strip line[18]. They are commonly used in some standardization procedures and for pre-qualification and investigations in R&D laboratories. For the precise measurement on our demonstrator, we use a wide GTEM Cell. The main constraint is to respect a minima a ratio 1/3 of the distance between system and septum(conducted plate) to respect the TEM mode[19].

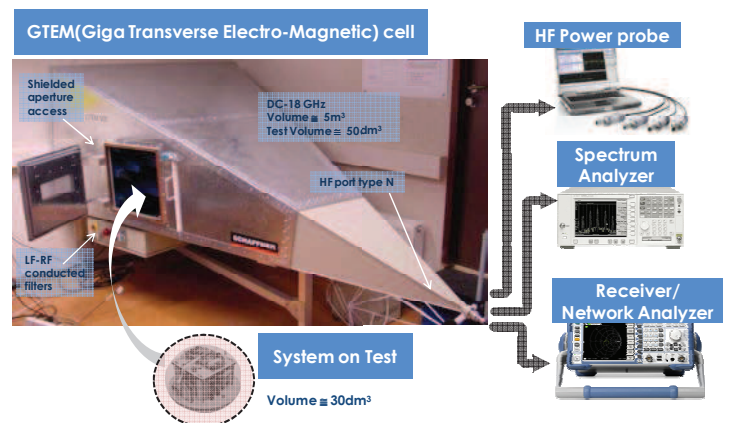

Fig. 8: GTEM- Radiated field experiment for electronic devices and small systems

We can obtain an emission figure that is pertinent, and confirm the hypothesis on the real wide-band emission peaks as represented in followed figure.

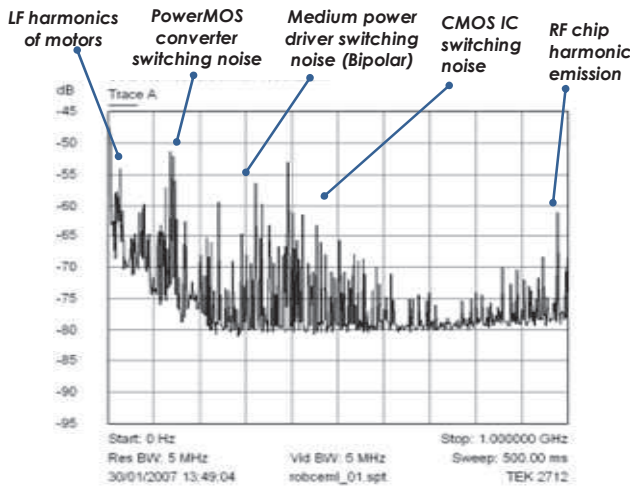

Fig. 9: Radiated electromagnetic field distribution of demonstrator ROB-CEM I

Analyze of the frequency diagram allows understanding and identifying the contributions and radiated sources linked to the architecture of the system:

- ✓ 10kHz/300kHz: Motors and harmonics of Motors
- ✓ 100MHz: Switching rate of Power transistors (MOS, IGBT), 1 to 2 μ s
- ✓ 250MHz: Switching rate of power drivers (Power Bipolar Transistors), 100 ns
- ✓ 400/600MHz: Switching rate of CMOS / CPLD, 1ns
- ✓ 800-980 MHz: RF Chips noises (carrier)

2.4 Immunity of the system

The investigation of the immunity and electromagnetic risks consist in three steps:

- Define one or many criteria's default
- Define the type of aggression: harmonic and transient signals, direct (conducted) or near/far field couplings.
- Choosing the kind of coupling behaviors with parameters as frequency, levels, direct or radiated couplings

The immunity investigation is less trivial and more difficult to realize than the emission approach. It could appear a lot of conditions and parameters, and the aggressive character of the investigation can cause complex real defaults, even in out of bandwidth of the system [20]. For our demonstrator, we can focus on some elementary immunity cases:

- The system is mobile, so the aggressions are mainly radiated type and not direct conductive.
- Each part has a range of sensitivity, but the most weak part seems to be the CMOS circuits: they are supplied on low energy (5V) and they have a wider band –with.

The mode of couplings depends of elementary parasitic antenna formed by PCB wire and other parts connected. For example, when use of integrated circuits, some pins are unused because the function are not active, or some special control of IC, as Inhibit or Reset. If unused pins or other connections are in open circuit, they present a open loop

that is very favorable to Electric field couplings. If unused pins or connections are connected to the reference's connections of the system, they present an common impedance and a loop conductive surface. So the magnetic field coupling and the generation of voltage among the distance of connection can cause a sufficient energy that enter the circuit and trigger an involuntary switching. In these two cases, you have either electric-capacitive coupling, either magnetic-inductive couplings. If a far-field illuminate the circuit, as a RF signals of Wireless system, both electric and magnetic fields can couple and disturb the functional integrity of the device To resume, let's see on three experiment's demonstrations the qualitative effects of aggression on the prototype[16]:

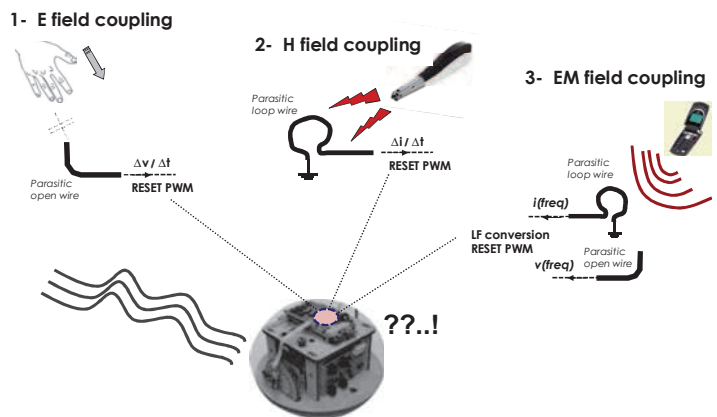

Fig. 10: Three canonical modes of coupling for radiated immunity

-Electric field coupling is realized by the "hand" effect: a slightly quasi-static shift in the near electric field, around the Reset pin stayed in open circuit, is realized by moving a conductive charged element (the hand or other) close to the pin; the command of one wheel of the system is perturbed and the main consequences is a loss of trajectory and nominal function.

-Magnetic field coupling and effect is visualized by injecting a magnetic field in a loop: to avoid Electric field coupling conditions, the ideal and state of the art is to rely Reset pin and unused pins of device to a reference voltage. But this configuration realizes a closed loop, and with the reference conductor as common impedance, some disturbing current voltages are derived. The aggression is simulated by a ESD (Electrostatic Discharge) that generates both E and H field during triggering. If placed in a normal direction to equivalent surface formed by the closed circuit or wire, a transient current is coupled and is sufficient to trigger once again the Reset function. So the effect and consequence on the circuit is the same than previously. But we feel and see that this aggression is less reproducible and more dependent of orientation than the first case.

-A last case, complementary of the previous ones, is to generate an equivalent established harmonic Field with a RF source, for example a mobile phone nears the command board. The coupling to trigger the Reset is more difficult to establish, because the equivalent density of energy less

intensive and directive than previous cases of aggression. Also a "natural" protection is obvious because of the tentative of coupling a high frequency signal: the carrier of the RF Source, in the range of 900MHz, 2.4 GHz and the natural low bandwidth of electronics victims. But in certain conditions, a very common scenario of coupling/immunity can arrive: the envelop detection. Because of inherent presence in PCB and components as resistance, capacitance, and junction (semi conductor P-N), either localized or parasitic in electronic devices, we have a involuntary demodulator or peak detector configuration. So the low frequency timing and pattern of RF Signals can be detected, as the envelope of the RF carrier often used in CW or FM transmission. These conditions could be sufficient to trigger once again the Reset or other inputs on circuits, and having a disturbing case of the system.

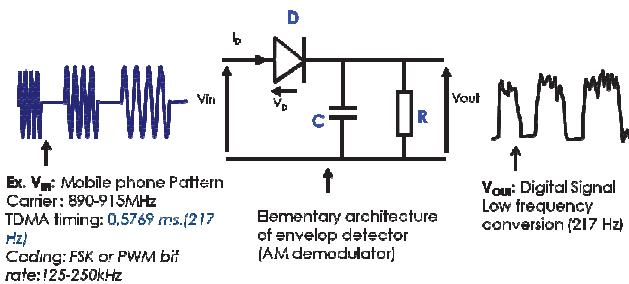

Fig. 11: Example of envelop detector principle as a parasitic demodulator signal and low frequency conversion signal.

In conclusion, immunity is a more difficult domain to investigate and to resolve, with the pressure that a scenario of coupling and reaction can lead to very serious consequences on the integrity of the behavior of a system.

After this presentation of global interactions and susceptibility effects on the system, we will focus on main techniques to qualify and evaluate the internal contributions of emission, couplings and immunity cases at circuit level.

3 FOCUS ON EMISSION AND EM NOISE OF ENERGY/POWER MODULES

3.1 The sources and couplings in power structures

We present a canonical prototype that want to review main behaviors of emissions of switching module used for energy conversion and supply in most modern system[21][22][24]. The demonstrator PCB is representative of an elementary architecture of a power cell, using actual transistors technology as MOS power or IGBT. These components are reported on a PPCB (Power Printed Circuit Board) with some quality for dissipating temperature. Three cases of emission will be presented: the Conducted mode, the Near-field mode and the Far field mode.

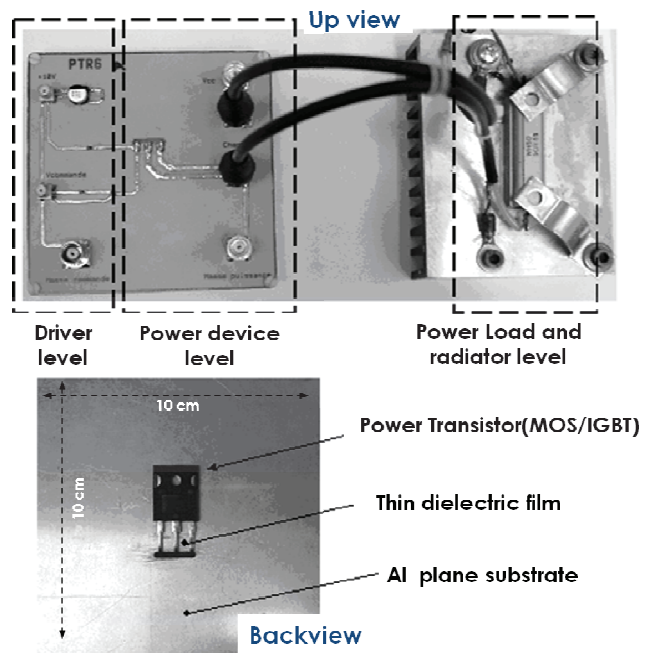

Fig. 12: Views and description of canonical power PCB demonstrator (PTR_6)

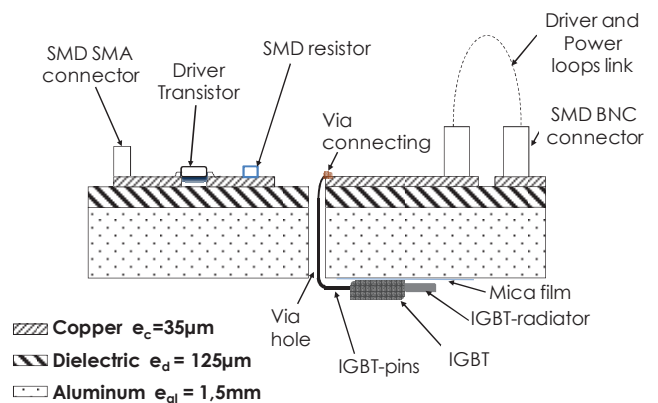

Fig. 13: Transversal view of Power PCB demonstrator PTR6

3.2 The investigations conducted mode and integrity signal

3.2.1 The experiment

Conducted mode and investigations can be realized on main PCB with a wide band oscilloscopes associated to voltages probes and currents probes. A system calibrated at 1 GHz is correct today to have a good conducted characterization for both common devices on PCB. Some oscilloscopes have nowadays input impedance that can be shift sometimes on 50 ohms that improve the sensibility and the frequency adaption of the connections. If available, the use of a spectrum analyzer will be more pertinent for the signal to noise rejection and the frequency resolution. Voltages probes, especially in switching mode characterization must be compensated in frequency. For current probes, it exist high frequency loop current probes that can be inserted in the PCB[23][24].

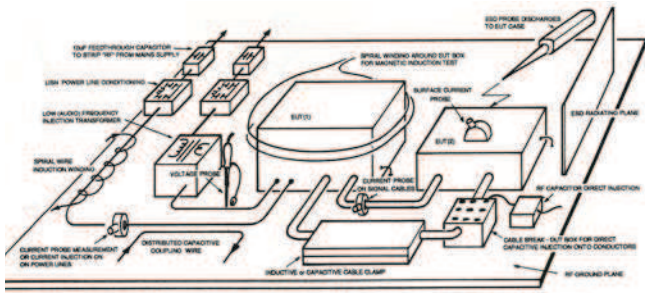

Fig. 14: RF coupling techniques for typical conducted EMC testing[25]

3.2.2 Results and parametric behaviors

First conducted results give a view of the real waveforms in different points of the board prototype. Interesting conclusions is the overvoltage on power supply and ground; also the measure of pseudo-oscillation ($f = 1,7$ MHz) or Δt of these signals give pertinent information. Main conclusion is that important disturbances are in common mode or impedance: in wire or cable of Power supply, in wires and planes of ground, in radiators on the component and the load, in routing/connecting configurations. The main reduction/optimization of the emissions can be obtained by using adequately bypass/decoupling capacitors or filters, optimizing the ground/supply routing and modifying electrical conditions of the switching [16].

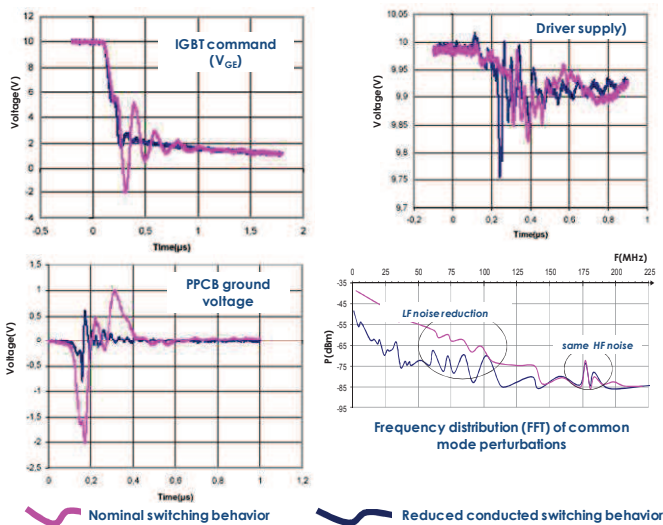

Fig. 15: 4 examples of qualitative reduction of conducted perturbations

3.3 The investigations of Radiated Emission

3.3.1 Near-field radiated mode

Near-field mode characterization is an alternative but complementary method between conducted and far field characterization [26]. In near-field mode, the components of the electromagnetic field have interesting properties or characteristics:

- Magnetic field issue from intensive variations of current $\Delta I/\Delta t$
- Electric field issue from intensive variations of voltage $\Delta V/\Delta t$
- Spatial localization and repartition of the field's contributions and origins

- Identification of “hot” spots of high current-low impedance part of the boards, high voltage-high impedance parts of the board.
- Characterization without conductive insertion problem and losses; and independent of the connective access

3.3.2 Near-field radiated characterization [26][28]

Near-field probes are essentially two types: Electric field as a monopole or open-circuit structure and Magnetic Field as a loop or short circuit structure. The high-performances of the near-fields probe are the size resolution linked to the band with. It exists commercial probes, characterized by attenuation factors and other-component field ratio rejection. For particular uses or others performances, it's possible to design by own near-field probes, with HF coaxial cables or printing on substrates[29][30][31]

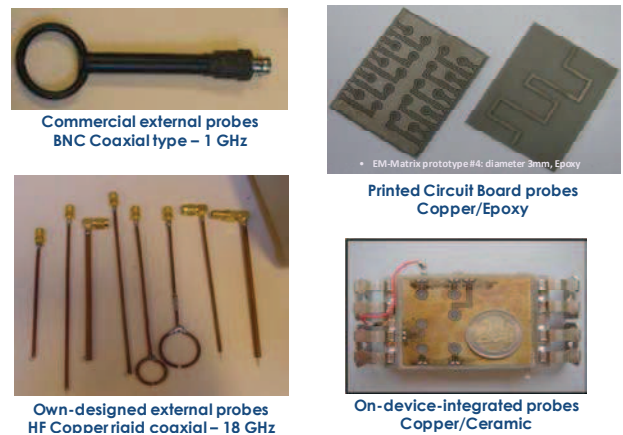

Fig. 16: examples of different near-field probes and antennas for EMC testing

The quality of the experiment depends also of the use of rigorous mechanical test fixture, to maintain precisely probes and to shift over a surface keeping a good absolute resolution. So, some supports, motorized or not, moving in X, Y and Z directions, must be associated to Near field probes to obtain pertinent and serious scan figures. In this case, the Near-field experiment has to be driven in all directions, and deal with different Electric or Magnetic fields components: E_x, E_y, E_z and H_x, H_y, H_z .

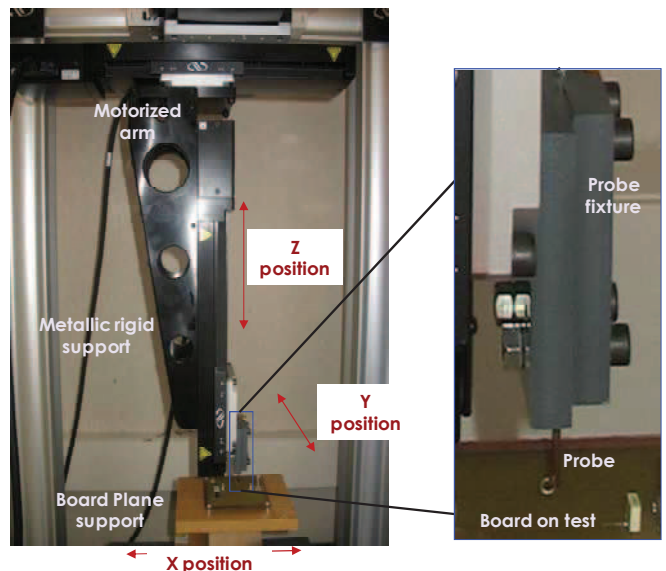

Fig. 17: example of a near-field scan test bench and fixtures

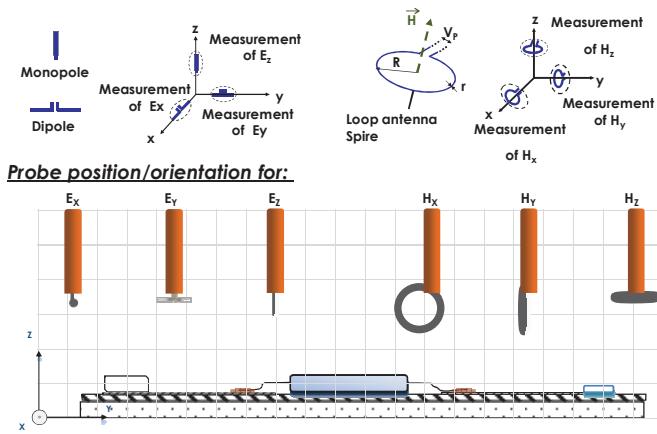
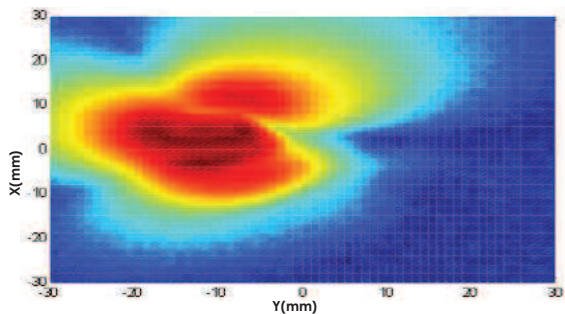

Fig. 18: Principles and procedures for 3D near-field testing[32]

3.3.3 Near-field radiated results

As said previously, the E/H scan of the prototype is a confirmation of conductive dynamic behavior. An example of global scan in H-field mode is reported here for the power PCB with it's main active chip.



2D measurement of H_z magnetic-field component

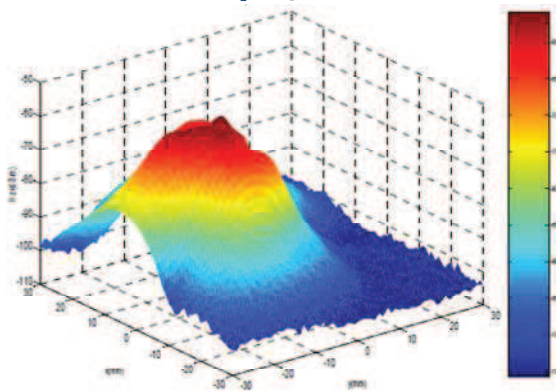

3D measurement of H_z magnetic-field component

Fig. 19: Examples of global scan figures of power chips and PCB [33]

Some specific zones can be tested precisely, without problem of insertion, so to have qualitatively comparison of different frequency and positions behaviors. For Power PCB, it's the case of image of high current variation, where H-field probe can show very intensive zone of switching current and equivalent generated frequency resonances. We can have also a comparison of radiated chip behavior, as illustrated in result of our prototype (MOS vs IGBT)

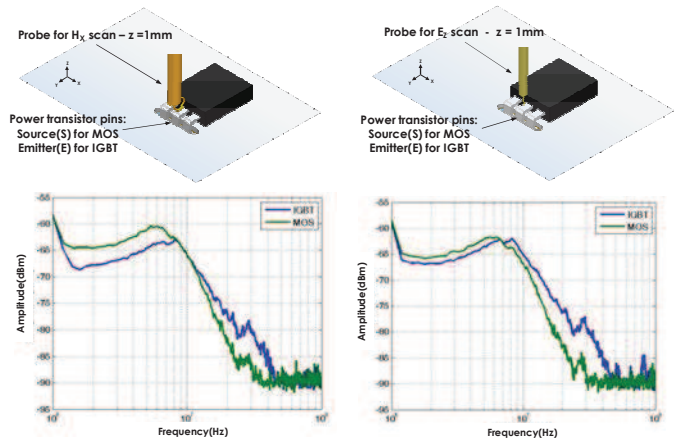

Fig. 20: Examples of specific localized scan figures on pins of power transistors (MOS& IGBT)[34]

3.3.4 Far-field or established-Field mode

To complete emission investigation on the electronic board, characterization of radiated emission can be driven. Here is a review of actual techniques to measure radiated emission on electronic boards[35][36][37] :

Radiated Method	Frequency Range	Interest	Constraints
Stripline	100 kHz – 1GHz	Wideband testing Low cost testing	Size, Length Specific PCB test
TEM - Crawford	300 kHz – 6 GHz	Wideband testing medium cost testing On PCB Sequential testing	Size depending of Band-width Specific PCB test Orientation of the PCB
GTEM	DC – 25 GHz	Size independent of Band-width Hybrid and complex PCB, small systems	Testing dependent of Device on Test Sizes Losses and attenuation factors Cost
MSRC	>100 MHz HIGH FREQUENCY	Precision and repeatability Wide range of power and frequency Wide range of device sizes	Dimensions Complex use and specific techniques Cost

Tab. 4: Review of different radiated measurement equipment adapted to components/circuits electronic devices.

As said, TEM cell family is a convenient way to have a representative view of radiation of medium/small electronic structure in alternative to OATS or Chamber measurement. A normalized TEM cell (called Crawford Cell) is used in the official standards for pre-qualifying PCB and Integrated circuit. The TEM cell, uses a strip line configuration that is shielded. The user must realize specific PCB, with following rules:

- Components chips to be characterized mounted on the inside face of the PCB
- Connecting, supply, decoupling, others function and connectors to the outside
- Distance of the chip inside TEM cell and septum must be optimized, that is a minima a ratio of 1/5 à 1/3.
- The Band-width of EM noise attended must be in adaptation with band-width of the TEM cell.

3.3.5 Radiated emission of power chips and PCB with PTR6 demonstrator.

The prototype demonstrator here is a PCB in respect of TEM Cell aperture dimension: 10cm*10 cm

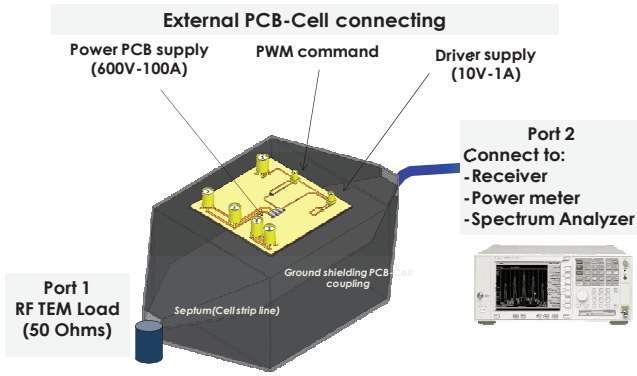

Fig. 21: Radiated TEM Cell experiment of Power PCB PTR6

One interest of TEM CELL is that user can design its own prototype, in respect with conditions of TEM mode, to investigate radiated figures of sequential part of a board. The power chip for example, is placed alone in our canonical PCB prototypes. So, different technologies of power/smart power chips are tested with a same PCB routing, to have a relative comparison of radiated and switching EM noises from different technologies. Main contributors to excessive emissions can be evaluated and linked to different EMC choices.

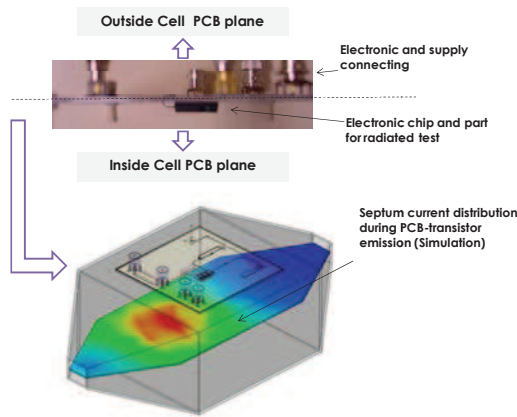

Fig. 22: 2D/3D views of Radiated TEM Cell experiment of Power PCB PTR6

Measurements are realized commonly to a receiver or spectrum analyzer. In this last case, we can compare and identify the impact of the switching conditions on the emission source, and especially rely it to main frequency resonances of the PCB routing and architectures. We retrieve same behaviors and frequency peaks either in Near-field studies, either in global system analyze observed on Rob-Cem I.

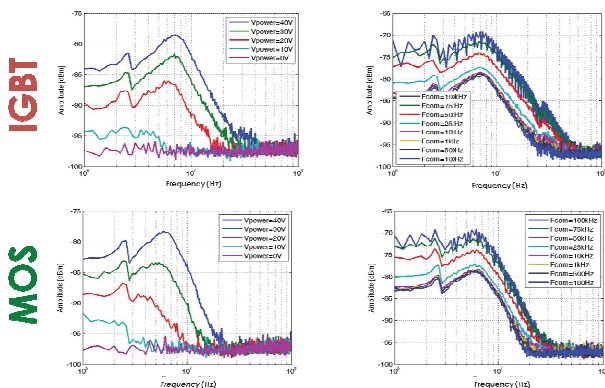

Fig. 23: Comparison of radiated behavior for different Power technologies and electrical conditions [34]

4 FOCUS ON IMMUNITY AND SUSCEPTIBILITY OF ELECTRONIC DEVICES FOR COMMAND.

We now review and describe immunity problematic centered on a particular and common victim in an electronic architecture: the device and PCB used to control and command the system. The immunity approach by the way of EMC, is considered as a parasitic couplings that occurs a shift in nominal functions of the system, at least a temporally loss of function. Destructive effects are not considered, but it's a domain of EMC for the view of intentional aggressions.

KIND OF RISK	EXAMPLES
LIGHT DISTURBANCE	Noise on Video
DEFAULT WITH RAPID RECOVER	Reset of Modem
LOSS OF MISSION/FUNCTION	Flash memory or micro-controller's program erased
SEVERE – NO DESTRUCTION	Shutdown of PC
VERY SEVERE – PARTIAL DESTRUCTION	CMOS chip killed

Tab. 5: The main immunity default risk in electronics

4.1 The different architectures of PWM

Pulse Width Modulation has become a major signal pattern for many electronic functions: telecommunications, digital coding, digital modulation, motor command, and supply active control. PWM signals generations and control are integrated in many electronic complex chips, processor and μ controllers. For specific use, especially in mobile, Embedded and Mechatronic applications, designers have to realize and use dedicated circuits with PWM optimized command, to respect high level of control of the system. With EMC point of view, PWM pattern can be considered of the main potential victim in the configuration system, and if disturbed by anyway, a major potential of electromagnetic risk with the consequences of loss of function and integrity missions of global mobile system.

4.2 Default criteria's and conditions.

At electronic chips and semi-conductor, many causes of susceptibility and dysfunction have been listed, for example here.

	ANALOG ELECTRONIC	DIGITAL ELECTRONIC	POWER ELECTRONIC
Noises on nominal signal	▼		
AGC in saturation	▼		
Motor moves	▼	▼	▼
Lost of information in RAM		▼	
Component Reset		▼	▼
Latch-up power on/off	▼	▼	▼
Bit error		▼	
System Switch Off		▼	▼
Semiconductor destruction	▼	▼	▼
Accumulator destruction			▼

Tab. 6: The main defaults and susceptibility cases in electronics

If we focus on PWM signal characteristics, the main susceptibility criteria is the shift of different waveform's parameter of the PWM, that can derive an involuntary mean current which modifies the nominal command. The mean current wanted is realized by electrical parameters as switching margins, switching supply levels, cyclic rate and nominal frequency. They can be all defined as default's criteria. Another consideration is the packaging of device or chips used for signal generation. As a digital type signal, others functions and pins associated are often accompanying the function, as Errors Compensation, Reset, High-level forcing, Watch dog etc... Used or unused, these pins are other ways of default, activated by unintentional triggers especially in pulsed parasitic aggression signals. To resume, a review of immunity cases have been investigated both in pulsed/transients signals aggression and harmonic wide -band signals with the PCB demonstrators presented here.

Immunity Method	Type	Kind of signal	Characteristics
DPI(Direct Power Injection)	Conducted	Harmonic/Transient	Low power injection Capacitor couplings
BCI	Conducted	Harmonic/Transient	High power injection Magnetic coupling losses Faraday cage
STRIPLINE	Radiated	Harmonic	Low power Injection Testing dependent of Device on Test Sizes
TEM/GTEM cells	Radiated	Harmonic	Important power Injection Dimensions Specific Test boards
ESD	Conducted /Radiated	Transient	Contact aggression or wave aggression High Voltage
MSRC	Radiated	Harmonic	Homogeneous aggression Good rate of injected/aggression power

Tab. 7: Typical types of immunity testing approaches on electronics

4.3 Pulsed/transient mode aggressions

4.3.1 Experimental pulsed aggressions

In pulsed mode aggression, different waveforms shapes can be used[25][38][39][40].

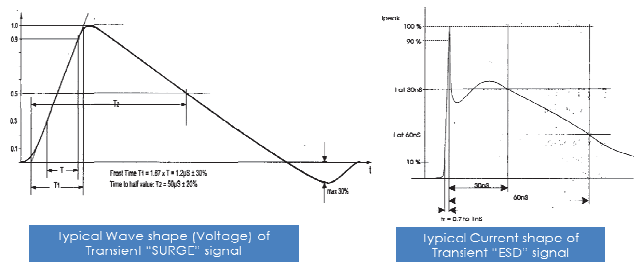

Fig. 24: Examples of two Transient Aggression signals for immunity testing

The main parameter of the experiment is the peak or means equivalent level of the transient pulsed waveforms that can be linked to equivalent energy or power with the normalized waveforms of aggression used. The coupling mode can either be conducted or radiated. In conducted mode, it's generally a closed coupling mode by the way of Capacitor or Inductors couplings, or contact aggression in the case of ESD Testing. In this case, the second main parameter is the localization of the injection on the board or device. In radiating mode, an Electric type or Magnetic type

antenna can be used, placed at limit of near-field conditions. Two others parameters are important in these conditions: the distance between the board victim and the source aggression, and the position/orientation of the board.

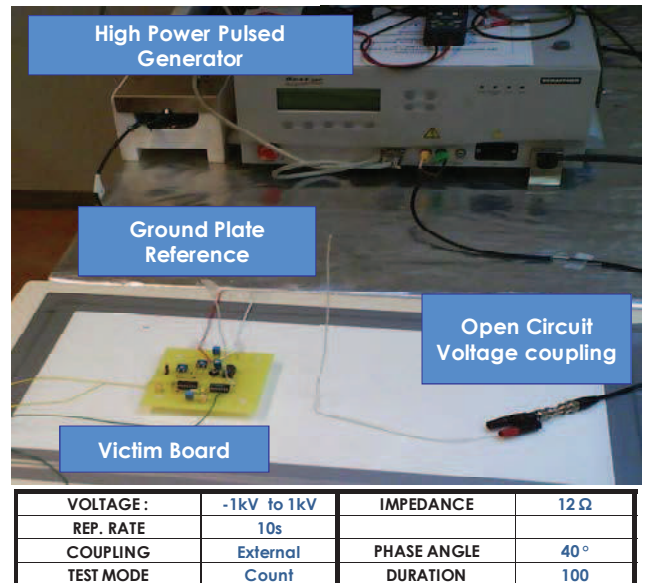

Fig. 25: Pulsed/transient surge immunity experiment

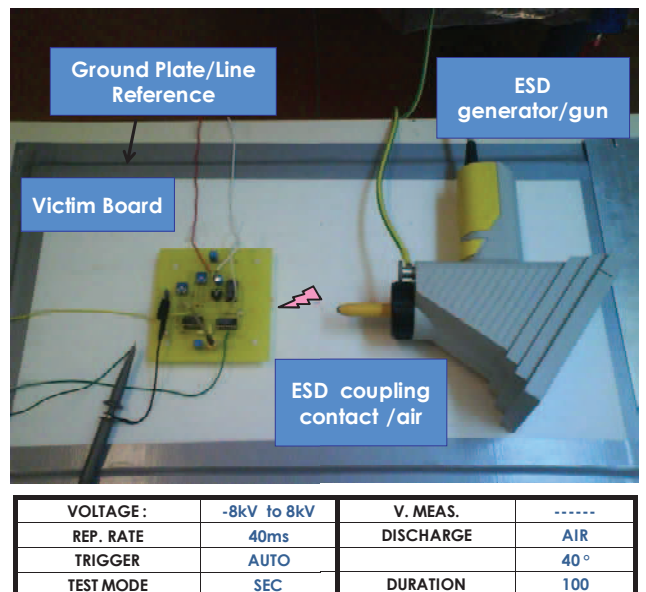

Fig. 26: ESD contact/air immunity experiment

4.3.2 Examples of results on canonical test Board

Special test board reproducing a canonical PWM command for mobile system have been developed for immunity tests demonstrations. They illustrate main cases of susceptibility and aggression scenarios that can be activated by pulsed aggression waves[41].

For criteria default named CRIT01, the visualization on oscilloscope of nominal PWM signal and by the activity of a LED helps to validate the criteria, by YES or NO.

For default CRIT02, the very short transient time of activation needs to be visualized at the oscilloscope with one-shot trigger programming to detect the disappearance or appearance of the PWM signals.

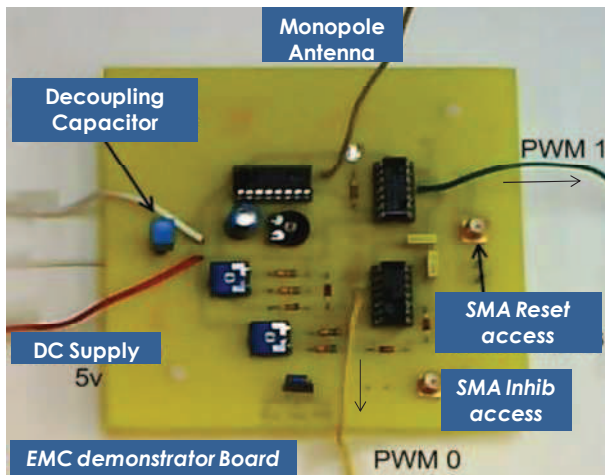

DEFAULT CRITERIA	DESCRIPTION	EFFECTS/OBSERVATIONS	TIMING
CRIT01	INHIB triggering (HCT123)	PWM output forced to 1 digital state Red LED on	800ms
CRIT02	RESET triggering (NE556)	NE556 output signals forced to 0 digital state	25ms

Fig. 27: Transient immunity testing on demonstrator PCB(Robcom)

For example, two kind of pulsed aggression experiment are presented

Experiment 1: conducted/near-field by discharge on contact/or closed, with following conditions:

Parameter 1: aggressions points or zones. Here we define 5 Points on the chips and PCB.

Parameter 2: Levels in voltage of Transient/Surge/ESD aggression signals. Here, a range of +/- 2kV.

PARAMETER 1:	AGRESSION ZONE	Pin INHIB	Pin RESET	Pin ROUND1	Pin SUPPLY1	Pin GROUND2
PARAMETER 2:	CRIT01 ON for Level <0	-200V	-1kV	-600V	-600V	-1kV
AGRESSION LEVEL	CRIT01 ON for Level >0	+200V	+300V	+800V	+400V	+300V

Tab. 8: Results of Transient immunity testing on demonstrator PCB

Experiment 2: Radiated pulsed aggression.

The generation of pulsed field can be obtained either by a High transient voltage in a open-circuit, by a High transient current in an low impedance circuit, or both Electric-magnetic field by an ESD discharge in ground connection. Many parameters can be activated for this type of aggression:

Parameter 1: E Field coupling or H-field illumination.

Parameter 2: PCB- source distance, typically from 5cm to 2m.

Parameter 3: range of peak level voltage excitation from +/- 8kV centered on 0V

Parameter 4: PCB – source orientations

In the figure, example of results is given, where CRIT01 has been tested with experiment parameters #1, #2 and #3.

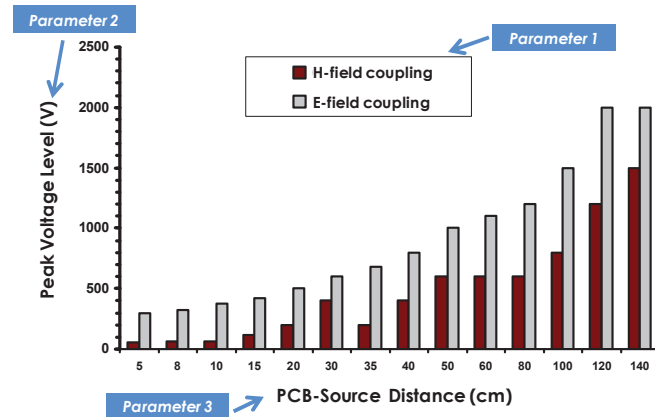

Fig. 28: Results of radiated Transient immunity testing on demonstrator PCB

4.4 Harmonic/CW mode aggressions

4.4.1 Experimental test setup

The experimentation consists to illuminate the board with a harmonic CW signals. Either Electric field component or Magnetic field component of the electromagnetic wave generated could be coupled on equivalent high impedance or closed connecting and wires of the system. To confine the aggression and keep reproducibility in experiment, the system has to been protected from outside electromagnetic ambient noise. As for emission concerns, at device electronic level, the alternative of OATS-EM chambers is the use of versatile TEM configuration.

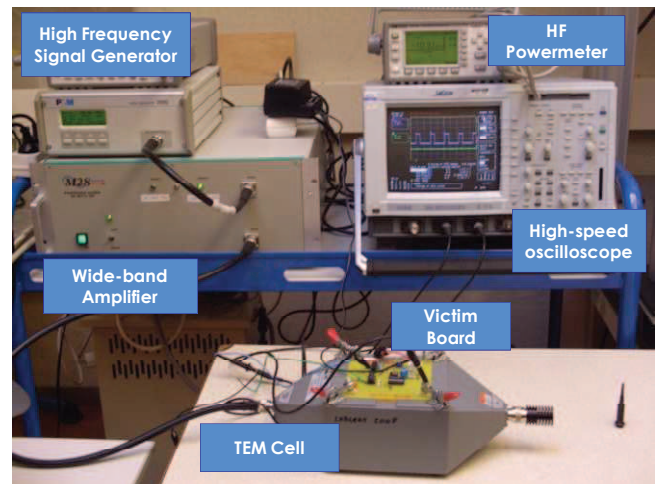

Fig. 29: Harmonic-wave immunity experiment with TEM cell configuration

A high power/wide band amplifier is necessary to be used in conjunction with HF signal generator and Experiment Cell band-widths. The mains parameters of the experiment will be the levels of power injected among the frequency. Another complementary parameter will be the orientation of the PCB/board in the TEM or GTEM Cell, because of the characteristics of equivalent plane wave in the TEM mode that can have different coupling actions. In these case also, many new criteria default can be activated in the same time, so sequential studies can be planned.

Since many years, some pertinent immunity experiments use Reverberation chamber technique[42][43]: a wide band frequency signal is injected in a resonant cavity or chamber

where a motorized antenna realizes an homogenous repartition of electromagnetic fields and frequency modes. That experiment assumes a complete illumination of a 2D object (PCB) or 3D object(System). In this case, the parameters of immunity test as localization and the main part of the couplings susceptibility modes of an object are entirely excited and tested.

4.4.2 Examples of results on canonical test Board

The dimensions 10x10cm² of Robcom board demonstrator has been planned to be inserted in the TEM Cell. The use of TEM cell allows testing different configurations of technologies. Here, for example, two prototypes assuming the same functions are designed either in double-layer discrete device techniques, either in on layer-SMD technology[41]. We have a difference of routing and wire dimensions sizes to immunity cases comparison.

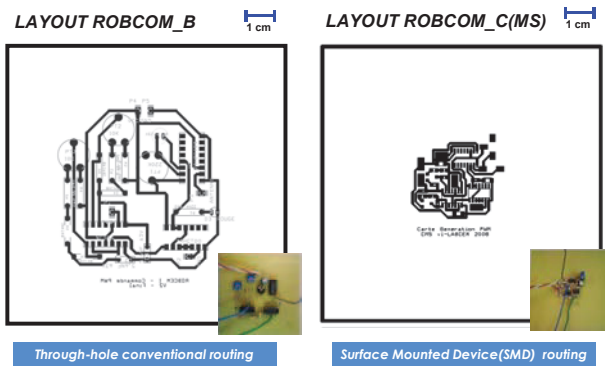
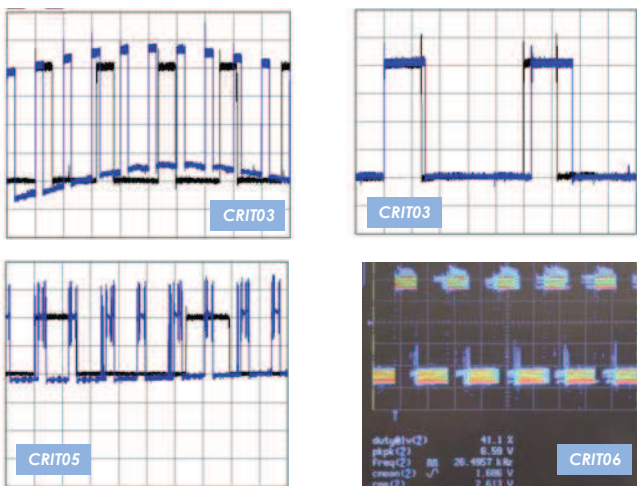

Fig. 30: View and differences of two different technical realizations of a same functional command board

Complementary default criteria can be used in this experiment, because of the nature of the signal aggression that will reproduce a established permanent aggression. So some slight susceptibility effects on the PWM characteristics have to be considered.



DEFAULT CRITERIA	DESCRIPTION	EFFECTS/OBSERVATIONS	TIMING
CRIT03	PWM Cyclic Rate shift	Oscilloscope detection	Perm.
CRIT04	Shift of Switching Margins of PWM	Oscilloscope detection	Perm.
CRIT05	Jitter- slide of nominal PWM frequency	Oscilloscope detection	Perm.
CRIT06	Shift of Mean Value of PWM	Oscilloscope detection on N periods	Perm.

Tab. 9: Others defaults and criteria for PWM Signal integrity qualification

For detecting and validate these default(YES/NO), a digital oscilloscope is necessary, with statistical and alarms/triggers functions, to help the default hard survey conditions. The level of shift of the different criteria can be nominally fixed to a certain percent (%) of shift from the nominal/non aggressed value, typically for qualitative experiment at 10%. Once one or many default criteria chosen, the experiment is realized with the PCB in TEM cell, with sequential parameters:

Parameter 1: variation of the aggression frequency from Low to High values

Parameter 2: Variation of aggressions levels, in W or dBm, from low to high values

Parameter 3: Orientations of the board depending of septum geometry of the TEM Cell

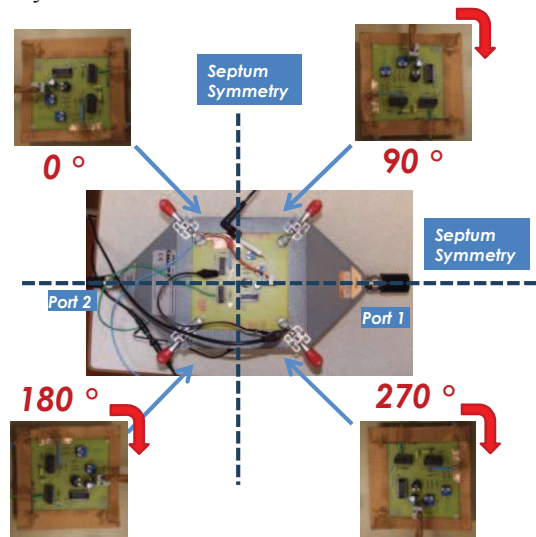

Fig. 31: View of different orientations of PCB for Immunity TEM cell testing (Parameter #3).

Synthesizes of results for 1GHz test on boards are presented. That shows the difference and the importance of criteria's choice to a rigorous susceptibility investigation and conclusions at electronic device and PCB levels.

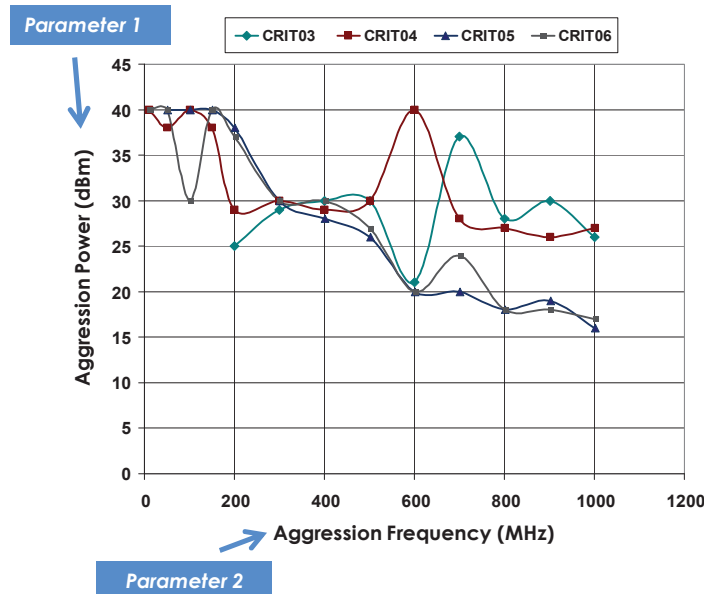

Fig. 32: Comparative results of Immunity testing of demonstrator PCB with harmonic-TEM mode aggression for CRIT#03 to CRIT#06.

5 ISSUES AND NEW EM INTERACTIONS INVESTIGATIONS IN ELECTRONICS

Based on these basics and synthetic presentations, we complete this tutorial paper with some issues and trends of EMC/EMI problematic and scenarios of investigation. Three category of impact of electronic performances and progress in investigation of actual and future EM interactions are reviewed, based on state of research and development works. At this state, because of the complexity and the integration of the system, EMC actors have to use and develop new ways and tools of EMC investigations, both in characterization and modeling domains[44].

5.1 Impact of new electronics performances and technologies

As mainly demonstrated in this paper, the major cause of involuntary wide band sources and EM noises is due actually to switching mode of use of transistors and chips. Power and energy control systems are now in the global range of 1 GHz, with very severe problematic of integrity signal on supply and power connections[45], and very intensive near-field levels closed to the device, as shown in the following figure[34]

Processor and digital electronics circuits are now considered also as radiating critical levels above 10 GHz, because of chip size reduction: from 45nm to 5 nm, and increase in density of chips.

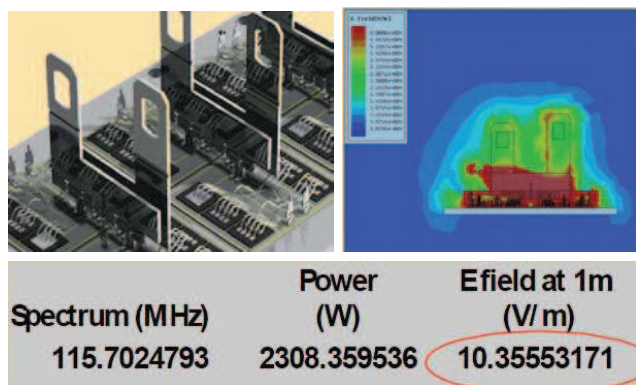

Fig. 33: Intensive Electric field emission on High Power Component (calculation)

The main causes of couplings and immunity cases in electronics architectures are also enforced by many aspects: -the high performances of sensors, that are more and more sensitive and placed in close distance of multiple sources. Integrated and agile wide-band patch antennas for example, are becoming a standard.

-the transistor and smart chips are working in lower supply levels, so to reduce power and thermal consumptions. So the switching margins of digital semi-conductor chips decrease. For example, a 65nm CMOS technology is supplied by 2,5V on I/O, and 1,2V at Core level.

New connecting and packaging techniques increase the number of connections and reduce the size of wiring

techniques [14]. Example is shown here, with, high speed PCB, multilayer and via holes techniques that become critical problem for PCB radiating in 3D configurations.

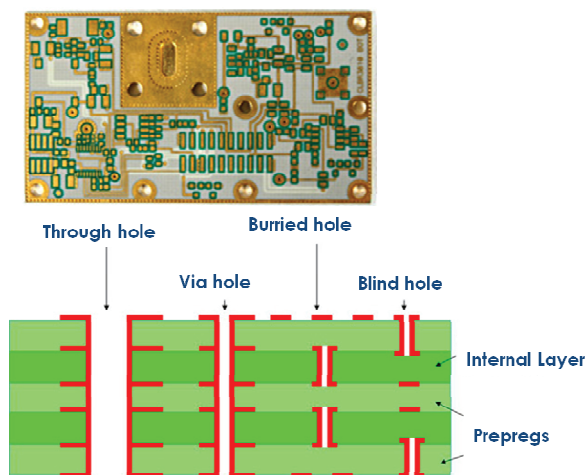

Fig. 34: Examples of new high performance PCB & packaging techniques

5.2 Impact of new multiphysics constraints

As illustrated by the demonstrator system Rob-Cem I, in a mobile or embedded system, electronics have to function in a real autonomous environment. Many impacts of real exterior agents have a non negligible incidence on EM behavior, emission and immunity figures.

-the temperature is a key physics factor in electronics function, either for dissipating electric power, either for modifying electronics characteristics by the way of the semiconductor basic structure PN junction. Some works recently started [47] have shown non-negligible influence of thermal impact on EMC figures of electronics parts. Examples are shown here, where both emission and immunity behavior of electronic chips (FPGA) are measured among different temperature, and indicate different EMC cases that at ambient reference[48].

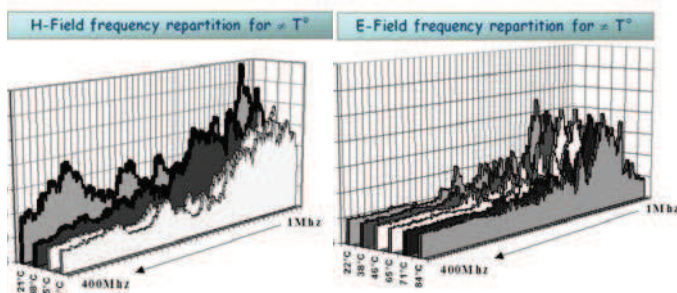

Fig. 35: Impact of temperature on radiated emission of electronics

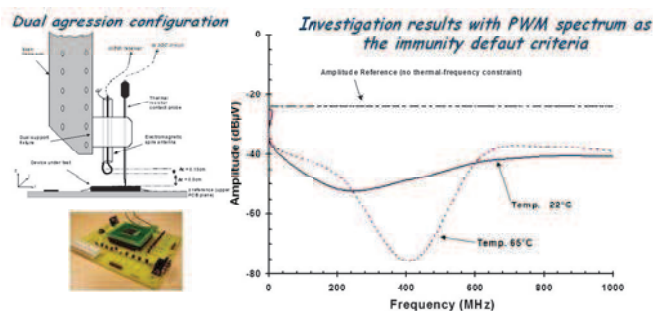

Fig. 36: Impact of temperature on radiated susceptibility of electronics

-Indirectly, a new approach that is to consider EMR (Electromagnetic Reliability) that concerns the ageing and physical fatigue of electronics structures, due both to intensive use and also physical aggressive external agent as temperature, humidity mechanical vibrations. So EMC behavior is obviously modified in the time life of the structure. Example of first study of this case is given in [49]

5.3 Impact of embedded / 3D architectures

A mobile or embedded application has to deal with two main constraints, as reminded previously :

-A finite volume, with the more light weight of the structures

-A finite energy to function in autonomy

So, many new aspects of EMC couplings are becoming a key problematic and acting on robustness and integrity of the system. The closed integration of electronics parts, in 2D or 3D configurations, can enforce new near-field couplings, where the source and the victim are designed for[50][51][52]. The EMC problematic is named intra-system, where EMC margin issue is not realized, so the circuit or device cannot function properly for its nominal use. Two examples are given here, for a Mobile phone typical PCB and a Hybrid High Power switch. As worked properly in a previous technology and mature designing, the new realization of these devices has lead to unfortunately conjunction of both emissions and susceptibility margins, and critical internal couplings that lead falls of attended performances .

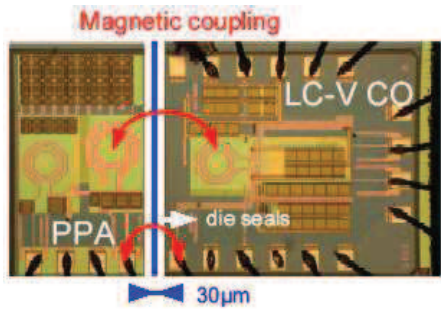

Fig. 37: Example of near-field couplings between chips function (Amplifier, VCO) inside a mobile phone PCB

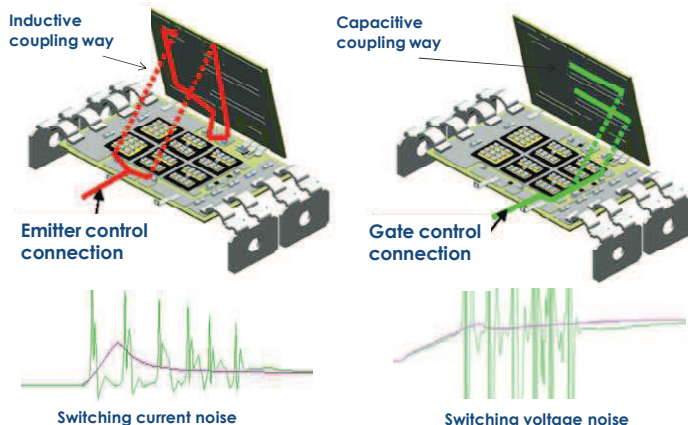

Fig. 38: Example of near-field and conducted noises emitted inside an hybrid 3D integrated power switch

At very low levels of designing, some research topics are now starting and considering EMC investigations for new electronic domain as nanotechnology level [53].

6 CONCLUSIONS

This paper wants to make a synthetic and tutorial view of general Electromagnetic Compatibility and Interferences approach, focused on Electronics devices. Basic principles and methodologies have been reminded and presented. As EMC concerns more and more domains of the electricity and electronics devices, we point our presentation on representative electronic technology that is nowadays used in all commercial and public application: PED, computer, mobile system, electric vehicle, etc. These electronics chips and circuits work actually in a preferential switching mode, either for power/supply management, either for signal information and control command. They have to work in conjunction, and with many others complementary function (ADC conversion, sensors, integrated antennas, battery, high speed memories etc) so they can realize what is called Smart functions. This paper wanted to review and investigate the main EMC phenomena's on these structures. A canonical example of mobile system and PCB's demonstrators has been used to illustrate all the sequential approach to investigate and understand major cases of emission and immunity. Basics experiment techniques and interpretations have been declined. Many people that could be interested in these domains can have a state and start point of view to decline studies and research works. For this, the last part wanted to point actual new problematic around EMC in electronics, without exhaustive description. Many synthesizes of this paper are issued from both pedagogical and research approach in EMC of electronics, mainly driven and supported by a dedicated project platform LABCEEM of University P. Sabatier, France[54]. Any technical or intellectual additional information on the demonstrator and the figures presented are available on the Platform web link or by contact the author.

7 REFERENCES

- [1] "CEM : Normes, Mesures Simulations", *Revue de L'Electricité et de l'Electronique*, Vol. N°5, 1995.
- [2] "Faut-il avoir peur de la CEM ?", *Revue Electron*, n°79, Mars-Avril 1996.
- [3] C.R. Paul, "Introduction to Electromagnetic Compatibility", *Wiley Interscience Publication*, 1992.
- [4] "Rayonnement, conduction, émission, susceptibilité, problèmes d'Harmoniques et Réseaux EDF", *Ecole d'été CEM, Grenoble, 7-11 Juillet 1997*.
- [5] M. Lamarche, "Quelques expériences pour se familiariser avec les problèmes de CEM", *Bulletin de l'Union des Physiciens*, Vol. 91, N°794, Mai 1997.

- [6] "Maîtrise de la CEM : technologies, réglementations, normes ", Les Référentiels Dunod, Ed. Dunod, 2004.
- [7] J.M. Dienot, "Cemland, Tarbes (A64, sortie ouest)", *Revue des Départements de Génie Electrique et Informatique Industrielle, GESI n°69, pp 34-36, Juin 2007.*
- [8] M. Montrose, "EMC and the Printed Circuit Board : Design, Theory and Layout made simple", *IEEE Press on Electronics technology, Wiley Interscience, 1998.*
- [9] J. Whalen, "Predicting RFI Effects in Semi-conductor Devices at Frequencies Above 100 MHz", *IEEE Trans. On Electromagnetic Compatibility, Vol. 21, 1979.*
- [10] R. Ramchandani and al., "Electromagnetic Interference (EMI) design criterion for power electronics building block (PEBB)", *Annual report for ONR, Airlington VA, May 1997.*
- [11] T.C Edwards, M.B. Steer, "Foundations of Interconnect and Microstrip Design", *3rd Ed., J. Wiley and sons.*
- [12] S. Ben Dhia and al."Electromagnetic Compatibility of Integrated Circuits – Techniques for low Emission and Susceptibility", *Springer,ISBN 0-387-26600-3, 2006.*
- [13] B. Murari and al., "Smart power ICs", *Technologies and applications, 2nd Edition, ISBN 3-54043238-8, Springer Ed.*
- [14] K. Armstrong, "EMC for Printed Circuit Boards: Basic and advanced design and layout techniques", *ISBN 978-0-95555118-06, Nutwood UK Ed*
- [15] S. Weber and al." EMI couplings from automotive traction systems", *In Proc. IEEE EMC-S, , pp. 591-594 , May 2003*
- [16] J.M.Dienot , " Rob-cem I: une initiation complète aux problématiques de compatibilité électromagnétique dans les circuits et architectures électroniques embarquées.", *CETISIS-EEA, Grenoble, 8-10 Mars 2010.*
- [17] A. Orlandi, J. L. Drewniak, "Electromagnetic Compatibility issues in Mobile Computing", *IEEE transactions on mobile computing, vol 2 n° 4, Oct-Dec 2003.*
- [18] C. Groh and al., " TEM Waveguides for EMC measurements", *IEEE Trans. on Electromagnetic Compatibility,Vol.41, n°4, pp 440-445, 1999.*
- [19] P. Muccioli and al., "Investigations of the theoretical basis for using a 1 GHz TEM cell to evaluate the radiated emissions from integrated circuits", *IEEE EMC-Symposium, 1996.*
- [20] J. Baudet and al."Effect of electromagnetic Interference of high amplitude on FET-differential amplifier in the frequency range 100 MHz–1 GHz", *Int. Symp. on Electromagnetic compatibility, Roma(Italy), 1998.*
- [21] F. Fiori, "Prediction of RF Interference effects in Smart Power Integrated Circuits", *IEEE International symposium on EMC, pp. 321-324, 2000.*
- [22] R. Redl, "Power Electronics and Electromagnetic compatibility", *in Proc. 27th Annual IEEE Power Electronics Specialists Conference, 1996.*
- [23] M. A. Steffka, "Conducted Emissions and Power Supply Filters",*Global EMC University, IEEE Intern. Symp. on EMC, Honolulu (HI), July 2007.*
- [24] J.L. Cocquerelle, C. Pasquier, "Rayonnement Electromagnétique des convertisseurs à découpage", *EDP Sciences, 2002.*
- [25] D. Morgan, "A Handbook for EMC testing and measurement", ISBN 0863412629, IEE Ed.
- [26] J.C. Bolomey, "Introduction to near-field techniques for EMC applications: state of the art and prospective", *in Proc. IEEE Intern. Symp. on EMC, 2001, Vol.1*
- [27] IEC 61967-3: "Integrated Circuits, Measurement of Electromagnetic Emissions,150 kHz to 1 GHz – Part 3: Measurement of Radiated Emissions – Surface Scan Method", *Draft Technical Report, IEC, June 2005.*
- [28] T. Harada and al. "Near field magnetic measurements and their applications to EMC of digital equipment", *IEICE-Transactions on Electronics, Vol. E89-C (1), pp. 9-15, Jan. 2006.*
- [29] D. Castagnet and al., "Characterization of a near-field probe for IC cartography", *EMC Europe Symposium, Barcelona, (Spain), 2006.*
- [30] M. Kanda, "Standard probes for electromagnetic field measurements", *IEEE Transactions on Antennas and Propagation, Vol. 41(10), pp.1349–1364, Oct. 1993.*
- [31] G. Lourdel, J.M. Dienot, "Study, design and validation of an integrated close field-probe system for EMC investigations on a power hybrid structure", *in Proc. IEEE Intern. Symp. on EMC, 2004, Vol. 2.*
- [32] L. Bouchelouk and al., "Characterization of electromagnetic fields close to microwave devices using electric dipole probes", *International Journal of RF and Microwave Computer Aided Design, pp. 146-156, Feb. 2008.*
- [33] M. Boumenad and al., "Détermination du champ magnétique proche en utilisant les réseaux de neurones", *CNI'2-2011, Université A. MIRA – Béjaïa, 3-4 Mai 2011.*
- [34] E. Batista, J.M. Dienot, "EMC characterizations for Switching Noise Investigation on Power Transistors", *IEEE International Symposium on Electromagnetic Compatibility, Detroit, USA, August 18-23, 2008.*
- [35] B. Korber, "IC-Strip line - A new proposal for susceptibility and emission testing of ICs", *EMC COMPO, pp.125-129, Torino, 2007.*
- [36] The use of GTEM Cells for EMC", *Measurement Good Practice Guide n°65, January 2003.*
- [37] IEC 61967-2, "Measurement of electromagnetic emissions,150 kHz to 1 GHz –Part 2: Measurement of radiated emissions, TEM-cell method and wideband TEM-cell method (150 kHz to 8 GHz)", *Draft Technical Report, IEC, November 2007.*

- [38] 62132-4: "Integrated circuits – Measurement of electromagnetic immunity 150 kHz to 1 GHz – Part 4: Direct RF power injection method", *Technical report, IEC, February 2006*
- [39] G. Muchaidze and al., "Susceptibility scanning as a failure analysis tool for system-level electrostatic discharge (ESD) problems", *IEEE Trans. On EMC, vol. 50, n° 2, pp. 268–276, May 2008.*
- [40] "Electromagnetic Compatibility (EMC), Part 4: Testing and Measurement Techniques, Section 5: Surge Immunity Test", EN 610000-4-5 Std, 1995.
- [41] J.M.Dienot, "Une formation à l'immunité et la fiabilité électromagnétiques des cartes et circuits électroniques embarqués", *CETIS-EEA, Trois-Rivières, CANADA, 23-26 Octobre 2011.*
- [42] B. Demoulin, P. Besnier, "Electromagnetic reverberation chambers", *ISTE/WILEY, 2011, ISBN: 978-1-84821-293-0*
- [43] M. Bäckström and al., "Reverberation chambers for EMC susceptibility and emission analysis", *Review of radio science*, 1999-2002, ISBN 0-471-26866-6, W. Ross Stone Editor, 2002.
- [44] E. Hoene and al., "Simulating electromagnetic interactions in high power density converters", *IEEE PESC Conference, Recife, Brazil, 2005.*
- [45] M. Swaminathan, A.E. Engin, "Power Integrity Modeling and Design for Semiconductors and Systems", *Prentice Hall Ed., 2008.*
- [46] A. Castellazzi and al. "Full Electro-Thermal Model of a 6.5kV Field-Stop IGBT Module", *39th IEEE Conference of Power Electronics Specialists, Rhodes(Greece), June 15-19, 2008.*
- [47] J.M. Dienot, G. Lourdel, "Experimental study of thermal influence on EMC emissions of digital circuit on PCB", *In Proc. of EMC Zurich'05, pp. 299-302, February 2005.*
- [48] J.M. Dienot, "Investigations of electromagnetic behavior and interaction of motion control electronics devices.", *in Ultra-Wide-band Short Pulse Electromagnetic Book, n°9, pp375-385, Springer Science, ISBN 978-0-387-77844-0, April 2010.*
- [49] R. De Maglie and al. "Use of accurate chip level modeling and analysis of a power module to establish reliability rules", *in Proc. IEEE International Symposium on Industrial Electronics, 2006, Vol. 2, pp.1571–1576.*
- [50] T. Timo and al., "Integrated Circuit Position Optimization for Reduced Electromagnetic Interferences on Mobile Devices", *EMC Europe Symposium, Hamburg (Germany), 2008.*
- [51] E. Batista, J.M Dienot, "EMC Studies of Switching Noise and Near-Fields Couplings in Electrical Transport Architectures", *EMC Europe Workshop 2007, Paris(France), June 2007.*
- [52] D.G. Beetner and al., "Validation of Worst-Case and Statistical Models for an Automotive EMC Expert System", *Proceedings of the IEEE International Symposium on Electromagnetic Compatibility, Honolulu, 9-13 July, 2007*
- [53] Peng Sun and al., "Analytical Modeling for Crosstalk Noise Induced by Process Variations among CNT-based Interconnects", *IEEE Intern. Symp. on EMC, Austin(USA), August 2008.*
- [54] Plate-forme Labceem, "Contraintes Electromagnétiques & Electronique Mobile", <http://labceem.iut-tarbes.fr>



Jean-Marc DIENOT received the Ph. D degree in Microwave Circuits in 1994, and the French Research Diploma in applied Electromagnetic and Compatibility in 2007, from the University Paul Sabatier, France. He is actually a Senior Professor of the University at the Institute of Technology, Tarbes, France. Since 1995, he has been interested and involved by new Electromagnetic Interferences problematic and environments in modern electronics architectures. He has developed and leads an academic Plat-form, Labceem, dedicated for research and pedagogical engineering projects in EMI and EMC. He is author or co-author of about eighty contributions in revues, books, and conferences, and holder of two Patents. He is recipient of certifications and member of scientific societies in Electronic Power, EMC, Instrumentation, Near-field and Communications topics. Since 2004, he develop and participates at national and international courses and high-level formations for EMI and EMC diffusion.