



**HAL**  
open science

# Robust formation-tracking control of mobile robots in a spanning-tree topology

Janset Dasdemir, Antonio Loria

► **To cite this version:**

Janset Dasdemir, Antonio Loria. Robust formation-tracking control of mobile robots in a spanning-tree topology. *International Journal of Control*, 2014, 87 (9), pp.1822-1832. hal-00831459

**HAL Id: hal-00831459**

**<https://hal.science/hal-00831459>**

Submitted on 7 Jun 2013

**HAL** is a multi-disciplinary open access archive for the deposit and dissemination of scientific research documents, whether they are published or not. The documents may come from teaching and research institutions in France or abroad, or from public or private research centers.

L'archive ouverte pluridisciplinaire **HAL**, est destinée au dépôt et à la diffusion de documents scientifiques de niveau recherche, publiés ou non, émanant des établissements d'enseignement et de recherche français ou étrangers, des laboratoires publics ou privés.

# Robust formation-tracking control of mobile robots in a spanning-tree topology

Janset Dasdemir<sup>a</sup> and Antonio Loria<sup>b\*</sup>

<sup>a</sup> *Yildiz Technical University, Turkey*

<sup>b</sup> *CNRS, L2S-Supelec, 3 Rue Joliot Curie, Gif sur Yvette France.*

**Abstract.** We solve the formation-tracking control problem for mobile robots via linear control, under the assumption that each agent communicates only with one “leader” robot and with one follower. As in the classical tracking control problem for nonholonomic systems, the swarm is driven by a fictitious robot which moves about freely and which is leader to one robot only. For a spanning-tree topology we show that persistency of excitation on the velocity of the virtual leader is sufficient and necessary to achieve consensus tracking. Furthermore, we establish uniform global exponential stability for the error system which implies robustness with respect to additive bounded disturbances. From a graph viewpoint, our main result corroborates that the existence of a spanning tree is necessary and sufficient for consensus as opposed to the usual but restrictive assumption of all-to-all undirected communication.

**Keywords:** Mobile robots, formation control, tracking control, consensus.

## 1 Introduction

It is clear in a vast number of scenarios that a group of robots may accomplish certain tasks with greater efficiency, flexibility, robustness and safety than a single robot. However, coordinated motion requires in general more complex control schemes as well as path planning. For instance, it may be achieved through local individual tracking control on each robot provided that all agents communicate with each other; this is an assumption commonly made in the literature. Furthermore, in many applications such as search & rescue, surveillance or transportation, a group of mobile robots is supposed to follow a predefined trajectory while maintaining a desired formation shape. It is also often assumed that all robots in the swarm know the reference trajectory. Under such circumstances, the problem of formation control resembles that of tracking control repeated for each individual. Beyond the particular problem of trajectory tracking there are a number of challenging problems such as path-planning and path-following, fault detection, obstacle avoidance, *etc.* In this paper we focus on formation tracking control.

There are various formation-control methods proposed in the literature. According to the behavior approach of Balch and Arkin (1998), Lawton et al. (2003), desired behaviors such as obstacle avoidance or target seeking, are assigned to each vehicle and formation control action is determined by a weighted average of all desired behaviors. This approach is useful when agents have multiple competing objectives however, it typically relies on an all-to-all communication among agents and from an analysis viewpoint, it is generally mathematically complex. Following the virtual structure method Lewis and Tan (1997), Yoshioko and Namerikawa (2008) the entire formation is treated as a single body which can evolve in a given direction and orientation to build a predefined time-invariant formation shape. Although it is rather easy to prescribe the coordinated behavior and it has certain robustness to perturbations on robots, trajectories are generated in a centralized fashion leading to a virtual rigid structure; this may result in a point of failure for the whole swarm of agents. In the recent article Sadowska et al. (2011), so-called

---

\*Corresponding author. E-mail: loria@lss.supelec.fr

mutual coupling terms are added to the controller to cope with tracking and time-varying formations under perturbations however, the desired trajectories of each robot depend on the trajectory of the virtual structure and it relies on the assumption that the topology graph is undirected and may present communication constraints. The graph-theory approach as in Fax and Murray (2004), Olfati-Saber and Murray (2002), Ren and Sorensen (2008) relies on the definition of Laplacian matrices to describe communication links and stability of the system is ensured by stability of each individual system and the connectivity of the graph. It is important to mention that the papers mentioned above are restricted to linear systems. On the other hand, in Dong et al. (2006) the graph theory approach is used in order to design controller for nonholonomic mobile agents.

The leader-follower approach as in Desai et al. (2001), Fierro et al. (2001) is reminiscent of master-slave synchronization. Extended to the case of more than two agents, one or more vehicles may be considered as leader and the rest of the robots are considered followers as they are required to track their leaders' trajectories with a predefined formation shape. In the context of mobile robots, a virtual reference vehicle is assumed as a leader over all the rest. From a graph viewpoint, it is the reference vehicle which plays the role of a root node. Leaders are children of the root node that is, robots which "know" the reference trajectory. All other nodes are either followers and leaders simultaneously (intermediate nodes in the graph topology) or they are followers (leaves, nodes without children in the graph topology). Besides being easy to understand and to implement, the method is scalable for any number of agents. There is no explicit feedback from followers to leaders (the graph is directed) but followers require full state information of their leaders.

In Guo et al. (2010), an adaptive leader-follower based formation control without the need of leaders' velocity information is proposed. It is assumed that two robots act as leaders hence, they know the prescribed reference velocity, while the others are considered to be followers, with single integrator dynamics. A stability analysis shows that the triangular formation is asymptotically stable while the co-linear one is not. In Shao et al. (2007), the authors present a three-level hybrid control architecture based on feedback linearization; the analysis relies on graph theory. It shows that position error system is asymptotically stable with a bounded orientation error. In Ghommam et al. (2011), a virtual vehicle is designed to eliminate velocity measurement of the leader then using backstepping and Lyapunov's direct method position tracking control problem of the follower is solved. The proposed method guarantees asymptotic stability of the closed loop error system dynamic. Another asymptotic stability result is presented in Consolini et al. (2008). The proposed control strategy ensures the follower position to vary in proper circle arcs centered at the leader's reference frame, satisfying suitable input constraints.

In Soorki et al. (2011) and LIU et al. (2007), feedback linearization and sliding-mode-based control is employed for two robots in a leader-follower formation. They exhibit robustness to bounded disturbances and unmodeled dynamics with asymptotically stable closed-loop system. In Sira-Ramírez and Castro-Linares (2010), the leader's influence on the trajectory tracking error dynamics is taken as an unknown but bounded, observable disturbance and eliminated by the local controllers of followers. Trajectory errors asymptotically converge to a small vicinity of the origin. In the presence of unknown internal dynamics, an optimal formation control problem is solved in Dierks et al. (2012). Using adaptive dynamic programming with NN, it is showed that the kinematic tracking error, the velocity tracking error and the parameter estimation errors are all uniformly ultimately bounded. In Gamage et al. (2010), three different formation control methods are addressed. Two of them are solved by using virtual robot path tracking techniques, one of which is based on approximate linearization of the unicycle dynamics and the other is formed using Lyapunov-based nonlinear time varying design. The third controller is developed through dynamic feedback linearization. A comparative study by means of stability and formation success of the proposed methods and an existing fourth static feedback linearization based formation controller is presented. In ZHANG (2010), consensus protocols under directed communication topology are designed using time-varying consensus gains to reduce the noise effects.

Asymptotic mean square convergence of the tracking errors is provided through algebraic graph theory and stochastic analysis.

In this paper, we follow a leader-follower approach; we assume that the swarm of  $n$  vehicles has only one leader which communicates with the virtual reference vehicle that is, only one robot knows the reference trajectory. The formation is ensured via a one-to-one unilateral communication that is, each robot except for the leader (root agent) and the last follower (tail agent), communicates only with one follower and with one leader. To the former the robot gives information of its full state, from the latter it receives full state information which is taken by the local controller as a reference. The communication graph is directed that is, there exist no feedback from followers to leaders. We solve the problem for both models available in the literature: the velocity-controlled kinematics-only model and the force-controlled dynamic model (with an added integrator).

Our controllers are inspired by similar controllers previously reported for tracking control of a single robot. The control design and therefore the stability analysis problems, are divided into the tracking control for the translation variables and tracking of the heading angle. This separation-principle approach leads to fairly simple controllers, linear time-varying. The analysis relies on the ability to study the behavior of the translational errors and heading errors separately. For the former, it is established that a sufficient and necessary condition is that the reference angular trajectory of the virtual leader robot have the property of persistency of excitation, for the heading angles, a simple proportional feedback is enough. The analysis of the over-all closed loop system relies on tracking theorems tailored for so-called cascaded (time-varying) systems. The significance of the proof method relies in the circumvention of graph theory, eigen-value analysis and other tools difficult to extend to the realm of nonlinear systems. This makes our method particularly fitted for non-trivial extensions such as to the case of time-varying and state-dependent interconnections (for instance, in the case that the dynamics of the communication channel is considered).

The rest of the paper is organized as follows. In Section 2 we recall the kinematic model of the mobile robot and formulate the formation tracking control problem. In Section 3, we present our main results. In Section 4 we present some illustrative simulation results and we conclude with some remarks in Section 5.

## 2 Problem formulation and its solution

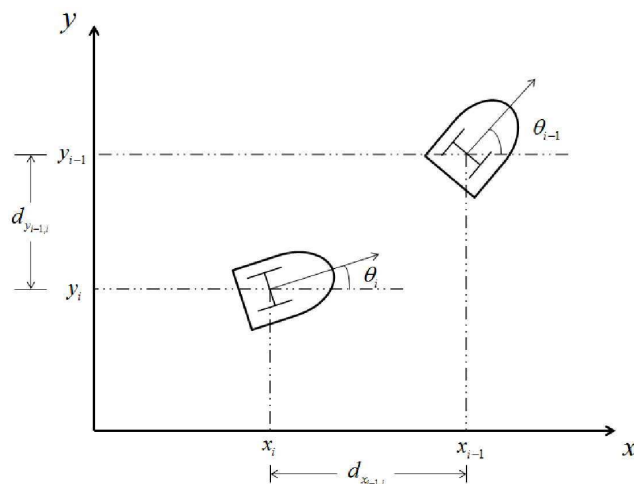

Figure 1. Generic representation of a leader-follower configuration. For a swarm of  $n$  vehicles, any geometric topology may be easily defined by determining the position of each vehicle relative to its leader. This does not affect the kinematic model.

Consider a group of  $n$  mobile robots, whose kinematic models are given by

$$\dot{x}_i = v_i \cos(\theta_i) \quad (1a)$$

$$\dot{y}_i = v_i \sin(\theta_i) \quad (1b)$$

$$\dot{\theta}_i = w_i, \quad i \in [1, n] \quad (1c)$$

where the coordinates  $x_i$  and  $y_i$  represent the center of the  $i^{\text{th}}$  mobile robot with respect to a globally-fixed frame and  $\theta_i$  is the heading angle –see Figure 1 and the linear and angular velocities of the  $i^{\text{th}}$  robot are denoted respectively  $v_i$  and  $w_i$ . In the case that each vehicle is velocity-controlled the decentralized control inputs are  $v_i$  and  $w_i$ .

The control objective is to make the  $n$  robots take specific postures determined by the topology designer, and to make the swarm follow a path determined by a virtual reference vehicle labeled  $R_0$ . Any physically feasible geometrical configuration may be achieved and one can choose any point in the Cartesian plane to follow the virtual reference vehicle. The swarm has only one ‘leader’ robot tagged  $R_1$  whose local controller uses knowledge of the reference trajectory generated by the virtual leader; in the communications graph,  $R_1$  is the child of the root-node robot  $R_0$ . The other robots are intermediate robots labeled  $R_2$  to  $R_{n-1}$  that is,  $R_i$  acts as leader for  $R_{i+1}$  and follows  $R_{i-1}$ . The last robot in the communication topology is denoted  $R_n$  and has no followers that is, it constitutes the tail node of the spanning tree –see Figure 2. We remark that the notation  $R_{i-1}$  refers to the *graph* topology as illustrated in Figure 2 but it does not determine a physical formation.

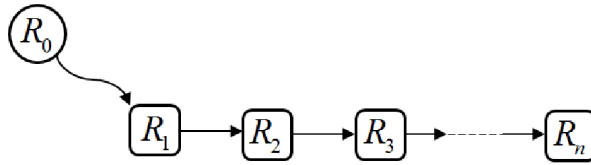

Figure 2. Communication topology: a spanning directed tree with permanent communication between  $R_i$  and  $R_{i+1}$  for all  $i \in [0, n - 1]$ .

The reference vehicle describes the reference trajectory defined by

$$\dot{x}_0 = v_0 \cos(\theta_0)$$

$$\dot{y}_0 = v_0 \sin(\theta_0)$$

$$\dot{\theta}_0 = w_0$$

that is,  $v_0$  and  $w_0$  are respectively, the desired linear and angular velocities communicated to the leader robot  $R_1$  only.

After the seminal paper Kanayama et al. (1990) we introduce error variables to denote the difference between the leader and follower states, in the present context these are the virtual reference vehicle  $R_0$  and the swarm leader  $R_1$ , then

$$p_{1x} = x_0 - x_1$$

$$p_{1y} = y_0 - y_1$$

$$p_{1\theta} = \theta_0 - \theta_1.$$

Next, we transform the error coordinates  $[p_{1x}, p_{1y}, p_{1\theta}]$  of the leader robot from the global

coordinate frame to local coordinates fixed on the robot that is,

$$\begin{bmatrix} e_{1x} \\ e_{1y} \\ e_{1\theta} \end{bmatrix} = \begin{bmatrix} \cos \theta_1 & \sin \theta_1 & 0 \\ -\sin \theta_1 & \cos \theta_1 & 0 \\ 0 & 0 & 1 \end{bmatrix} \begin{bmatrix} p_{1x} \\ p_{1y} \\ p_{1\theta} \end{bmatrix}. \quad (2)$$

In the new coordinates, the error dynamics between the reference vehicle and the leader of the swarm becomes

$$\dot{e}_{1x} = w_1 e_{1y} - v_1 + v_0 \cos e_{1\theta} \quad (3a)$$

$$\dot{e}_{1y} = -w_1 e_{1x} + v_0 \sin e_{1\theta} \quad (3b)$$

$$\dot{e}_{1\theta} = w_0 - w_1 \quad (3c)$$

and we proceed with the obvious modifications to express the “tracking” errors between any leader-follower couple of robots. Therefore, we may approach the formation control problem under a spanning-tree topology as a sequential leader-follower tracking problem. As it is observed in a large body of literature that followed Kanayama et al. (1990), the leader-follower tracking control problem boils down to the stabilization of the origin of (3) –see *e.g.* Lefeber (2000) and the references therein.

In Panteley et al. (1998) cascaded-based control is used to design linear controllers that stabilize the origin of (3); tools from linear adaptive control systems theory are used to establish stability. In this paper we extend this approach to the case of formation tracking control of several mobile robots interacting as it is explained above. Before presenting our main results it is convenient to explain the rationale of the control design and stability analysis methods that we employ.

## 2.1 Cascaded-based tracking control

Cascaded-based control relies on the ability to design controllers so that the closed-loop system has a cascaded structure,

$$\dot{x}_1 = f_1(t, x_1) + g(t, x) \quad (4a)$$

$$\dot{x}_2 = f_2(t, x_2) \quad (4b)$$

where  $x_1 \in \mathbb{R}^{n_1}$ ,  $x_2 \in \mathbb{R}^{n_2}$ . Note that the lower dynamics (4b) is independent of the variable  $x_1$  and the dynamic equation corresponding to the latter is “perturbed” by  $x_2$  through the *interconnection* term  $g(t, x)$ , hence the term *cascade*. Stability of the origin of the cascaded system may be asserted by relying on (Panteley and Loría 2001, Lemma 3), which establishes that the origin of a cascaded system is uniformly globally asymptotically stable if so are the respective origins of the disconnected subsystems that is, when the interconnection  $g \equiv 0$  and if the solutions of the perturbed dynamics (7) remain bounded. In the appendix we present a concrete stability theorem whose conditions serve as guidelines for control design and fits the purposes of this paper.

In that regard, it is important to stress that the error dynamics (3) already possesses a cascaded structure, with  $x_2 = e_{1\theta}$ ; indeed, the latter may be regarded as an input generating a perturbation to the translational dynamics equations (3a), (3b). With this in mind, we follow the approach originally proposed in Panteley et al. (1998), where uniform global exponential stability was first established for the tracking control problem with linear control and under persistency of

excitation conditions<sup>1</sup>. Define

$$v_1 = v_0(t) + c_2 e_{1x} \quad (5a)$$

$$w_1 = w_0(t) + c_1 e_{1\theta} \quad (5b)$$

then, the closed loop error dynamics can be obtained as follows

$$\dot{e}_{1x} = [w_0 e_{1y} - c_2 e_{1x}] + [c_1 e_{1\theta} e_{1y} + v_0 (\cos e_{1\theta} - 1)] \quad (6a)$$

$$\dot{e}_{1y} = [-w_0 e_{1x}] + [-c_1 e_{1\theta} e_{1x} + v_0 \sin e_{1\theta}] \quad (6b)$$

$$\dot{e}_{1\theta} = -c_1 e_{1\theta}. \quad (6c)$$

Note that the third equation is decoupled so the closed-loop system (6) conserves a cascaded structure. For the purpose of analysis we may re-write the first two equations in the compact form

$$\dot{e}_{1xy} = f_1(t, e_{1xy}) + g(t, e_{1xy}, e_\theta) \quad (7)$$

where  $e_{1xy} := [e_{1x}, e_{1y}]^\top$ ,  $\dot{e}_{1xy} = f_1(t, e_{1xy})$  corresponds to

$$\begin{bmatrix} \dot{e}_{1x} \\ \dot{e}_{1y} \end{bmatrix} = \begin{bmatrix} -c_2 & w_0(t) \\ -w_0(t) & 0 \end{bmatrix} \begin{bmatrix} e_{1x} \\ e_{1y} \end{bmatrix} \quad (8)$$

and

$$g(t, e_{1xy}, e_\theta) := \begin{bmatrix} c_1 e_{1\theta} e_{1y} + v_0(t) [\cos e_{1\theta} - 1] \\ -c_1 e_{1\theta} e_{1x} + v_0(t) \sin e_{1\theta} \end{bmatrix}.$$

The rationale to establish exponential stability of the origin of (6) based on cascades systems theory –see Loria and Panteley (2005) is roughly speaking, the following. Under the condition that  $c_1 > 0$  the origin of (6c) is exponentially stable, in particular,  $e_\theta \rightarrow 0$ . Furthermore, note that  $g(t, e_{1x}, 0) = 0$  therefore, stability of the overall system may be ensured if the origin of system (7) subject to  $e_{1\theta} = 0$  that is, the system (8), is exponentially stable and if the solutions of the perturbed system (7) are bounded. The latter may be easily verified; it is implied by the linear growth in  $e_{1x}$  of  $g$  for each  $t$  and  $x_2$  –see Theorem 6.1 in the Appendix. Exponential stability of the origin of (8) is established relying on adaptive control theory –see *e.g.* Narendra and Annaswamy (1989),

**Theorem 2.1:** *For the system*

$$\begin{bmatrix} \dot{e} \\ \dot{\theta} \end{bmatrix} = \begin{bmatrix} A & B(t) \\ -C(t)^\top & 0 \end{bmatrix} \begin{bmatrix} e \\ \theta \end{bmatrix} \quad (9)$$

*Let  $A$  be Hurwitz, let  $P = P^\top > 0$  be such that  $A^\top P + PA = -Q$  is negative definite and  $PB = C^\top$ . Assume that  $B$  is uniformly bounded and has a continuous uniformly bounded derivative. Then, the origin is uniformly globally exponentially stable if and only if  $B$  is persistently exciting that is, if there exist positive constants  $\mu$  and  $T$  such that*

$$\mu_1 I \leq \int_t^{t+T} B(\tau)^\top B(\tau) d\tau \quad \forall t \geq 0. \quad (10)$$

---

<sup>1</sup>See Lefeber (2000) for several extensions inspired by the main results in Panteley et al. (1998).

Therefore, the origin of (8) is uniformly globally exponentially stable if  $w_0$  is uniformly bounded, globally Lipschitz and

$$\mu \leq \int_t^{t+T} |w_0(\tau)|^2 d\tau \quad \forall t \geq 0. \quad (11)$$

Persistency of excitation may be roughly explained as the property that a signal may become null over intervals of time but of certain maximal length. In other words, a signal is persistently exciting if it is positive in an *averaged* sense. In summary, it may be established that the controller (5) ensures the global exponential tracking of a mobile robot provided that the reference angular velocity is “rich” (not equivalently equal to zero).

Our main results establish that this reasoning used in tracking control for the first time in Panteley et al. (1998), may be applied to solve the problem of formation control. We show that the controller (5) may be used locally on each robot where the reference velocities are replaced by those of the leader vehicle. Our first main result implies that consensus tracking that is,

$$\lim_{t \rightarrow \infty} e_{ix}(t) = 0 \quad \lim_{t \rightarrow \infty} e_{iy}(t) = 0 \quad \lim_{t \rightarrow \infty} e_{i\theta}(t) = 0 \quad (12)$$

is achieved by virtue of local controllers. Now, since in the context of formation control each robot acts as a leader to the following agent in the spanning tree, it might be conjectured that the condition to solve the formation tracking control is that the angular trajectory of each robot is persistently exciting. Remarkably, we show that as for the classical tracking control problem, for consensus tracking it suffices that the virtual vehicle’s *reference* angular velocity  $w_0$  be persistently exciting. We recall that this reference is unknown to all but the robot  $R_1$ .

### 3 Main results

We solve the formation tracking control problem using cascades-based control. Our main results apply to the general “dynamic” model in which it is assumed that the robot is force-controlled. However, for clarity of exposition we present first, a result for the kinematic case. To the best of our knowledge, under the assumptions used here, both results are novel.

#### 3.1 Formation control based on the kinematic model

We start by writing the error dynamics between any pair leader-follower robots starting with the leader  $R_1$ . The errors are generally defined by

$$p_{ix} = x_{(i-1)} - x_i - d_{x(i-1),i} \quad (13a)$$

$$p_{iy} = y_{(i-1)} - y_i - d_{y(i-1),i} \quad (13b)$$

$$p_{i\theta} = \theta_{(i-1)} - \theta_i - d_{\theta(i-1),i} \quad i \in \{2, \dots, n\} \quad (13c)$$

where  $d_{x(i-1),i}$  and  $d_{y(i-1),i}$  denote the desired distances between any two points on each mobile robot frame; for simplicity but without loss of generality these points are taken to be the origins of the local coordinate frames attached to each robot. Note that any formation topology may be defined by determining the values of  $d_{ixy}$ . In addition, one may define differences in the heading angles that is  $d_{\theta(i-1),i}$ . See Figure 1.



Using the same transformation given in (2) we obtain

$$\dot{e}_{ix} = w_i e_{iy} - v_i + v_{(i-1)} \cos e_{i\theta} \quad (14a)$$

$$\dot{e}_{iy} = -w_i e_{ix} + v_{(i-1)} \sin e_{i\theta} \quad (14b)$$

$$\dot{e}_{i\theta} = w_{(i-1)} - w_i \quad (14c)$$

hence, similarly to Section 2 we define the local control inputs

$$w_i = w_{(i-1)} + c_{1i} e_{i\theta} \quad (15a)$$

$$v_i = v_{(i-1)} + c_{2i} e_{ix} \quad (15b)$$

which replaced in (14), lead to

$$\begin{aligned} \dot{e}_{ix} = & w_{(i-1)} e_{iy} - c_{2i} e_{ix} + \\ & \underline{[c_{1i} e_{i\theta} e_{iy} + v_{(i-1)} (\cos e_{i\theta} - 1)]} \end{aligned} \quad (16a)$$

$$\dot{e}_{iy} = -w_{(i-1)} e_{ix} + \underline{[-c_{1i} e_{i\theta} e_{ix} + v_{(i-1)} \sin e_{i\theta}]} \quad (16b)$$

$$\dot{e}_{i\theta} = -c_{1i} e_{i\theta} \quad (16c)$$

for each  $i \in \{1, \dots, n\}$ . That is each set of equations (16) corresponds to the tracking error dynamics between a leader and a follower robot. For the sequel, the brackets underline the dependence of certain terms on  $e_{i\theta}$  and we remark that  $w_i$  are functions of  $e_\theta := [e_{1\theta}, \dots, e_{n\theta}]^\top$  and time since in view of (15a), we have

$$w_i = w_0(t) + \sum_{j=1}^i c_{1j} e_{j\theta}, \quad \forall i \geq 1.$$

Thus, the equations (16) may be written in cascade form

$$\begin{aligned} \Sigma_1 : \begin{bmatrix} \dot{e}_x \\ \dot{e}_y \end{bmatrix} = & \begin{bmatrix} -C_2 & W(t, e_\theta) \\ -W(t, e_\theta) & 0 \end{bmatrix} \begin{bmatrix} e_x \\ e_y \end{bmatrix} \\ & + \Psi(t, e_x, e_y, e_\theta) \end{aligned} \quad (17a)$$

$$\Sigma_2 : \dot{e}_\theta = -C_1 e_\theta \quad (17b)$$

where  $e_x := [e_{1x}, \dots, e_{nx}]^\top$ ,  $e_y := [e_{1y}, \dots, e_{ny}]^\top$ ,  $W(t, e_\theta) := \text{diag}\{w_i(t, e_\theta)\}$  with  $i \in [0, n-1]$  and the interconnection term

$$\Psi = \begin{bmatrix} c_{11} e_{1\theta} e_{1y} + v_0 (\cos e_{1\theta} - 1) \\ \vdots \\ c_{1n} e_{n\theta} e_{ny} + v_{(n-1)} (\cos e_{n\theta} - 1) \\ -c_{11} e_{1\theta} e_{1x} + v_0 \sin e_{1\theta} \\ \vdots \\ -c_{1n} e_{n\theta} e_{nx} + v_{(n-1)} \sin e_{n\theta} \end{bmatrix}. \quad (18)$$

where

$$v_i = v_0(t) + \sum_{j=1}^i c_{2j} e_{jx}, \quad \forall i \geq 1.$$

Note that  $\Psi(t, e_x, e_y, 0) \equiv 0$ .

We are ready to present our first result.

**Proposition 3.1:** *Consider the system (14) in closed loop with the controllers (15) with  $i \in \{1, \dots, n\}$  where  $c_{1i}, c_{2i} > 0$  and assume that*

$$\max\left\{\sup_{t \geq 0} |v_0(t)|, \sup_{t \geq 0} |w_0(t)|, \sup_{t \geq 0} |\dot{w}_0(t)|\right\} \leq b_\mu \quad (19)$$

for some  $b_\mu > 0$ . Then, the origin of the closed-loop system is uniformly globally exponentially stable if and only if  $w_0$  is persistently exciting.

*Proof* The closed loop dynamics is given by (17) therefore, we must show that the origin of the system is uniformly globally exponentially stable and that persistency of excitation of  $w_0$  is a necessary condition. We proceed by invoking Theorem 6.1 from the Appendix.

Let  $x_1 := [e_x, e_y]^\top$ ,  $x_2 := e_\theta$ ,

$$f_1(t, x) := \begin{bmatrix} -C_2 & W(t, 0) \\ -W(t, 0) & 0 \end{bmatrix} \begin{bmatrix} e_x \\ e_y \end{bmatrix} \quad (20)$$

where  $W(t, 0) := w_0(t)I$ ,  $C_1 := \text{diag}\{c_{1i}\}$ ,  $C_2 := \text{diag}\{c_{2i}\}$ ,

$$g(t, x) = \Psi(t, e_x, e_y, e_\theta) + \begin{bmatrix} 0 & W(t, e_\theta) - W(t, 0) \\ -W(t, e_\theta) + W(t, 0) & 0 \end{bmatrix} \begin{bmatrix} e_x \\ e_y \end{bmatrix}$$

and  $f_2(t, x_2) := -C_1 e_\theta$ . That is, the closed-loop dynamics (17) has the form (4). It is clear that the regularity assumptions on  $f_1$  and  $f_2$  (see the Appendix) hold in view of (19). Now, uniform global exponential stability of the origin of  $\dot{x}_1 = f_1(t, x_1)$  follows from Theorem 2.1 under the conditions of the proposition. On the other hand, uniform global exponential stability of the origin of (17b) is evident since  $C_1$  is diagonal positive definite.

It remains to show that Assumptions A1 and A2 of Theorem 6.1 in the Appendix hold. Assumption A1 holds with

$$V(t, x_1) = \frac{1}{2} \left[ |e_x|^2 + |e_y|^2 \right], \quad (21)$$

$c_1 = 2$  and  $c_2 = 1 = \eta = 1$ . The total time-derivative of  $V$  along the trajectories of  $\dot{x}_1 = f_1(t, x_1)$  where  $f_1$  is defined in (20), yields

$$\dot{V}(t, x_1) = -e_x^\top C_2 e_x \leq 0.$$

Finally, Assumption A2 holds in view of the fact that  $x_2 = 0$  implies that  $g = 0$  for any  $t \geq 0$  and  $x_1 \in \mathbb{R}^{2n}$  and both  $\Psi$  and  $W(t, e_\theta) - W(t, 0)$  are both linear in  $[e_x, e_y]$  and uniformly bounded in  $t$ , the latter comes from (19).  $\square$

### 3.2 Formation control based on the dynamic model

In this section, we extend the result of Proposition 3.1 to the case of the so-called *dynamic model* –see Panteley et al. (1998), Jiang and Nijmeijer (1997), which includes force-balance equations:

$$\dot{x}_i = v_i \cos(\theta_i) \quad (22a)$$

$$\dot{y}_i = v_i \sin(\theta_i) \quad (22b)$$

$$\dot{\theta}_i = w_i \quad (22c)$$

$$\dot{v}_i = \frac{u_{1i}}{m_i} \quad (22d)$$

$$\dot{w}_i = \frac{u_{2i}}{j_i}. \quad (22e)$$

In contrast to the kinematic model which is velocity-controlled the control inputs  $u_{1i}$  and  $u_{2i}$  correspond to force and torque respectively;  $m_i$  denotes the mass of the  $i$ th robot, while  $j_i$  stands for the the moment of inertia.

The objective is to find a control law  $u_i = [u_{1i}, u_{2i}]^\top$  of the form

$$u_{1i} = u_{1i}(t, e_{ix}, e_{iy}, e_{i\theta}, v, w) \quad (23a)$$

$$u_{2i} = u_{2i}(t, e_{ix}, e_{iy}, e_{i\theta}, v, w) \quad (23b)$$

such that the closed loop error dynamics is uniformly globally exponentially stable. To that end, we define the velocity error variables for the local control inputs as in the previous section:

$$\begin{aligned} e_{iv} &= v_i - v_{i-1} \\ e_{iw} &= w_i - w_{i-1} \end{aligned} \quad (24)$$

which, after<sup>1</sup> (3) and (13), leads to the following error dynamics

$$\dot{e}_{ix} = w_{(i-1)}e_{iy} - v_{i-1} + v_{i-1} \cos e_{i\theta} - e_{iv} + e_{iw}e_{iy} \quad (25a)$$

$$\dot{e}_{iy} = -w_{(i-1)}e_{ix} + v_{(i-1)} \sin e_{i\theta} - e_{iw}e_{ix} \quad (25b)$$

$$\dot{e}_{i\theta} = w_{i-1} - (e_{iw} + w_{i-1}) \quad (25c)$$

$$\dot{e}_{iv} = \frac{u_{1i}}{m_i} - \dot{v}_{i-1} \quad (25d)$$

$$\dot{e}_{iw} = \frac{u_{2i}}{j_i} - \dot{w}_{i-1}. \quad (25e)$$

As in the case of the kinematic model, we aim at decoupling via feedback, the translational error dynamics from the heading error dynamics. To that end let each local controller be defined by

$$u_{1i} = m_i (\dot{v}_{i-1} + c_{3i}e_{ix} - c_{4i}e_{iv}) \quad (26a)$$

$$u_{2i} = j_i (\dot{w}_{i-1} + c_{5i}e_{i\theta} - c_{6i}e_{iw}) \quad (26b)$$

–note that this controller requires the knowledge of  $u_{1(i-1)}$  and  $u_{2(i-1)}$ ; these do not need to be computed by the  $i$ th robot but their value may be received as a measurement, from the leading robot  $R_{i-1}$ . Define  $e_w := [e_{1w} \cdots e_{nw}]^\top$ , and similarly for  $e_x$ ,  $e_y$ ,  $e_\theta$ ,  $e_v$ . Then, replacing (26) in

---

<sup>1</sup>Making the obvious arrangements in the notation.

(25) and using  $w_{i-1} = w_i - e_{iw}$  we obtain by direct computation,

$$\dot{e}_{ix} = w_i(t, e_w)e_{iy} - e_{iv} + v_{i-1}[\cos e_{i\theta} - 1] \quad (27a)$$

$$\dot{e}_{iy} = -w_i(t, e_w)e_{ix} + v_{(i-1)} \sin e_{i\theta} \quad (27b)$$

$$\dot{e}_{i\theta} = -e_{iw} \quad (27c)$$

$$\dot{e}_{iv} = c_{3i}e_{ix} - c_{4i}e_{iv} \quad (27d)$$

$$\dot{e}_{iw} = c_{5i}e_{i\theta} - c_{6i}e_{iw}. \quad (27e)$$

We stress that for any  $i$ ,  $w_i$  is a function of  $e_w$  and time, indeed in view of (24) we have  $w_1 = e_{1w} + w_0(t)$ ,  $w_2 = e_{2w} + e_{1w} + w_0(t)$  and

$$w_i = e_{iw} + e_{(i-1)w} + \dots + e_{1w} + w_0(t), \quad \forall i \geq 3.$$

The system (27) has a cascades structure reminiscent of (17) in which the translation error dynamics is decoupled from the heading error dynamics. To see this, we first remark that the translation error dynamics may be rewritten in the compact form

$$\begin{aligned} \begin{bmatrix} \dot{e}_x \\ \dot{e}_v \\ \dot{e}_y \end{bmatrix} &= \begin{bmatrix} 0 & -I & W(t, e_w) \\ C_3 & -C_4 & 0 \\ -W(t, e_w) & 0 & 0 \end{bmatrix} \begin{bmatrix} e_x \\ e_v \\ e_y \end{bmatrix} \\ &\quad + \Psi_2(t, e_v, e_\theta) \end{aligned} \quad (28)$$

where  $W(t, e_w) = \text{diag}\{w_i(t, e_w)\}$ ,  $C_3 := \text{diag}\{c_{3i}\}$ ,  $C_4 := \text{diag}\{c_{4i}\}$  and the interconnection term is given by

$$\Psi_2 = \begin{bmatrix} (\text{Cose}_\theta - I)v \\ \text{Sine}_\theta v \\ 0_{n \times 1} \end{bmatrix} \quad (29)$$

where  $v := [v_0 \dots v_{n-1}]^\top$ ,  $\text{Cose}_\theta := \text{diag}\{\cos e_{i\theta}\}$  and  $\text{Sine}_\theta := \text{diag}\{\sin e_{i\theta}\}$  and note that each

$$v_i = e_{iv} + e_{(i-1)v} + \dots + e_{1v} + v_0(t), \quad \forall i \geq 3$$

hence  $v$  is a function of  $t$  and  $e_v$ . We also remark that  $\Psi_2(t, e_v, 0) \equiv 0$ . Finally, the heading error dynamics given by equations (27c) and (27e), become

$$\begin{bmatrix} \dot{e}_\theta \\ \dot{e}_w \end{bmatrix} = \begin{bmatrix} 0 & -I \\ C_5 & -C_6 \end{bmatrix} \begin{bmatrix} e_\theta \\ e_w \end{bmatrix} \quad (30)$$

where  $C_5 := \text{diag}\{c_{5i}\}$  and  $C_6 := \text{diag}\{c_{6i}\}$ . We recognize the desired cascaded structure; we are ready to present our second result.

**Proposition 3.2:** *Consider the system (22) in closed loop with the controllers (26) with  $i \in \{1, \dots, n\}$  where  $c_{3i}, c_{4i}, c_{5i}, c_{6i} > 0$  and the references  $v_0$  and  $w_0$  satisfy (19). Then, the origin of the closed-loop system is uniformly globally exponentially stable if and only if (11) holds.*

*Proof* The closed loop dynamics is given by (28), (30) therefore, we must show that the origin of this system is uniformly globally exponentially stable and that persistency of excitation of  $w_0$  is a necessary condition. As for Proposition 3.1 we rely on Theorem 6.1 from the Appendix. Let

us start by writing the closed-loop equations in a convenient form; define  $x_2 := [e_\theta, e_w]^\top$ , and

$$f_2(t, x_2) := \begin{bmatrix} 0 & -I \\ C_5 & -C_6 \end{bmatrix} \begin{bmatrix} e_\theta \\ e_w \end{bmatrix}. \quad (31)$$

then, we see that (30) has the form (4b). Now, let

$$A := \begin{bmatrix} 0 & -I \\ C_3 & -C_4 \end{bmatrix}, \quad B(t, e_w) := \begin{bmatrix} W(t, e_w) \\ 0 \end{bmatrix}$$

and let

$$f_1(t, x_1) := \begin{bmatrix} A & B(t, 0) \\ -B(t, 0)^\top & 0 \end{bmatrix} \begin{bmatrix} e_x \\ e_v \\ e_y \end{bmatrix} \quad (32)$$

where  $x_1 := [e_x, e_v, e_y]^\top$  and notice that

$$B(t, 0) := \begin{bmatrix} W(t, 0) \\ 0 \end{bmatrix} = \begin{bmatrix} I \\ 0 \end{bmatrix} w_0(t)$$

hence,  $B(t, 0)^\top B(t, 0) = w_0(t)^2 I$ .

Furthermore, let us introduce

$$g(t, x) = \begin{bmatrix} 0 & B(t, e_w) - B(t, 0) \\ -B(t, e_w) + B(t, 0) & 0 \end{bmatrix} \begin{bmatrix} e_x \\ e_v \\ e_y \end{bmatrix} + \Psi_2(t, e_v, e_\theta)$$

Notice that  $x_2 = 0$  implies that  $e_w = 0, e_\theta = 0$  hence,

$$g(t, x) \Big|_{x_2=0} = \Psi_2(t, e_v, 0) = 0.$$

We are ready to invoke Theorem 6.1. Assumption A1 holds with the quadratic function

$$V(t, x_1) = \frac{1}{2} \left[ e_x^\top C_3 e_x + |e_y|^2 + |e_v|^2 \right] \quad (33)$$

so the conditions (36) and (37) hold with  $c_2 = \max\{c_{3i}, 1\}$ ,  $\eta = 1$  and  $c_1 = 2c_2 / \min\{c_{3i}, 1\}$ . Furthermore, the total time-derivative of  $V$  along the trajectories of  $\dot{x}_1 = f_1(t, x_1)$  with the latter defined in (32) yields

$$\dot{V}_{(30)}(t, x_1) = -e_v^\top C_4 e_v \leq 0.$$

To see that Assumption A2 holds observe that  $x_2 = 0$  implies that  $g_2 = 0$  for any  $t \geq 0$  and  $x_1 \in \mathbb{R}^{3n}$  and  $\Psi_2$  is linear in  $[e_x \ e_v \ e_y]$  and uniformly bounded in  $t$ —see (29).  $\square$

#### 4 Simulation results

We illustrate our theoretical findings via some simulation results obtained using SIMULINK<sup>TM</sup> of MATLAB<sup>TM</sup>.

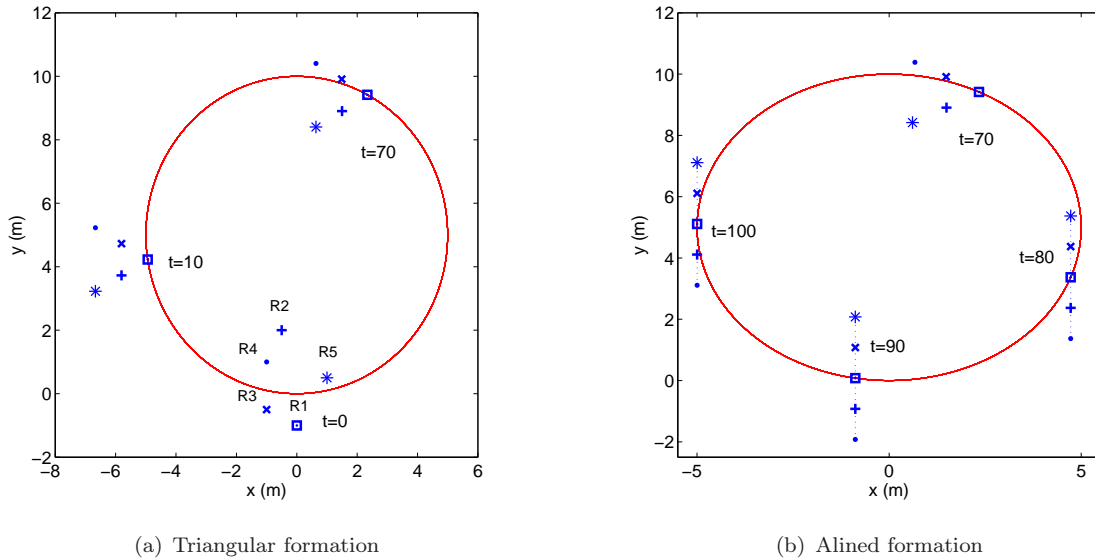

Figure 3. Motion and relative positioning of the robots in triangular and alined formation on the plane

We consider a group of 5 mobile robots. In a first stage of the simulation, the desired formation shape of the mobile robots is in triangular form with following initial condition;  $[x_1(0), y_1(0), \theta_1(0)]^\top = [0, -1, \pi/7]$ ,  $[x_2(0), y_2(0), \theta_2(0)]^\top = [-0.5, 2, \pi/5]$  and  $[x_3(0), y_3(0), \theta_3(0)]^\top = [-1, -0.5, \pi/4]$  and  $[x_4(0), y_4(0), \theta_4(0)]^\top = [-1, 1, \pi/8]$  and  $[x_5(0), y_5(0), \theta_5(0)]^\top = [1, 0.5, \pi/6]$  the triangular formation shape is obtained via  $[d_{x1,2}, d_{y1,2}] = [\sqrt{3}/2, 0.5]$  and  $[d_{x2,3}, d_{y2,3}] = [0, -1]$  and  $[d_{x3,4}, d_{y3,4}] = [\sqrt{3}/2, -0.5]$  and  $[d_{x4,5}, d_{y4,5}] = [0, 2]$ . In order to show the flexibility of the rigid formation, after an arbitrary period of time, we allow the formation shape to change from triangular to linear with a certain desired distance between the robots,  $[d_{x1,2}, d_{y1,2}] = [0, 1]$  and  $[d_{x2,3}, d_{y2,3}] = [0, -2]$  and  $[d_{x3,4}, d_{y3,4}] = [0, 3]$  and  $[d_{x4,5}, d_{y4,5}] = [0, -4]$ . In order to obtain the reference trajectory of the leader robot, we set the reference linear and angular velocities to  $[v_0(t), w_0(t)] = [15 \text{ m/s}, 3 \text{ rad/s}]$ . Furthermore, to test the robustness of the algorithm considering the fact that the reference trajectory is unknown to all but one leader robot, we applied an unknown, additive and non-vanishing disturbance signal to the follower robot ( $R_2$ ). The generated disturbance signal is a Gaussian distributed random signal  $\delta_v$  of zero mean which taking values between  $\pm 0.5$ .

#### 4.1 Kinematic formation control

In this section, we present the simulation results of the formation-tracking with the controller (15) with parameters  $C_1 = \text{diag}\{2\}$  and  $C_2 = \text{diag}\{5\}$ . As previously explained the desired formation changes abruptly from triangular to alined, after 70s –see Figure (3). In a second stage of simulation we apply a disturbance to the kinematics of the first follower ( $R_2$ ). The total simulation time is 120s.

In Figure 3(a), we show the motion and relative positioning of the robots in triangular formation. It is easy to see from the figure that the formation is established in less than 10s. In Particular, each robot tracks its neighbor with its desired off-set, while the leader tracking the reference trajectory with a satisfactory performance. In Figure 3(b), we show the change of the formation shape which occurs at  $t = 70$ s. As it is appreciated in the Figure, the line formation is also achieved after a short transient, inferior to 10s. The rapid response and excellent performance may be appreciated from the plots of the formation-tracking errors, depicted in Figures 4–6. The overshoots observed in the transient parts are due to the desired trajectory and the initial conditions at the moment when the reference trajectory changes abruptly.

Next, we demonstrate the position and orientation errors of the robots when the robot ( $R_2$ )

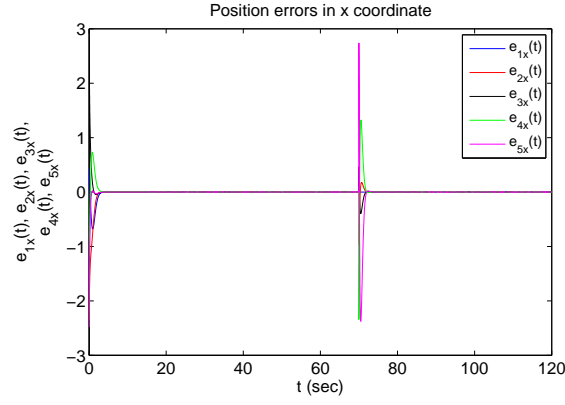

Figure 4. Position errors in  $x$  coordinates with kinematic control algorithm.

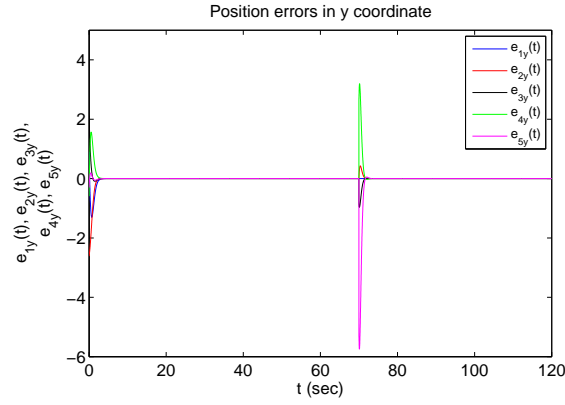

Figure 5. Position errors in  $y$  coordinates with kinematic control algorithm.

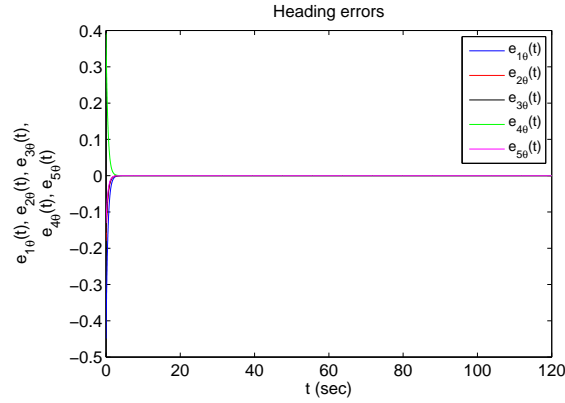

Figure 6. Heading errors with kinematic control algorithm.

is subjected to an additive, non-vanishing disturbance with their zoom in on the transient part of their responses. As it may be appreciated from Figures 7–8 the controlled system is robust in the sense that the steady-state error is kept considerably small. The effect of the disturbances on the orientation error is null and therefore it is not showed. As expected from the communication topology (spanning tree) and from our main result, the response of the global leader does not change. Because the position errors of the follower robot ( $R_2$ ) converge to a small neighborhood of the origin, the performance of the latter robots are very satisfactory.

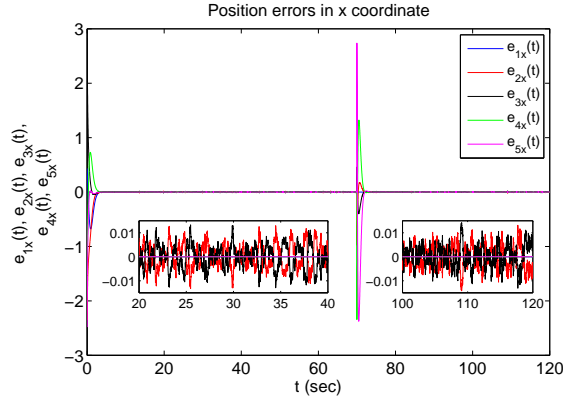

Figure 7. Position errors in  $x$  coordinates with kinematic control algorithm under disturbance.

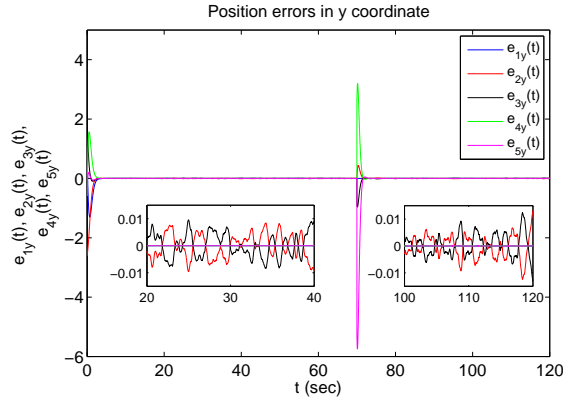

Figure 8. Position errors in  $y$  coordinates with kinematic control algorithm under disturbance.

#### 4.2 Dynamic formation control

Now we present numerical simulation results on formation-tracking for systems modelled by (22), under the controller (26). The controller gains are fixed to  $C_3 = \text{diag}\{12, 17, 17, 17, 17\}$ ,  $C_4 = \text{diag}\{5\}$  and  $C_5 = C_6 = \text{diag}\{10\}$ . For the sake of consistency, we repeat the previous scenario: the desired triangular formation changes to aline-formation after 70s then, we apply a disturbance  $\delta_v$  to the robot ( $R_2$ ).

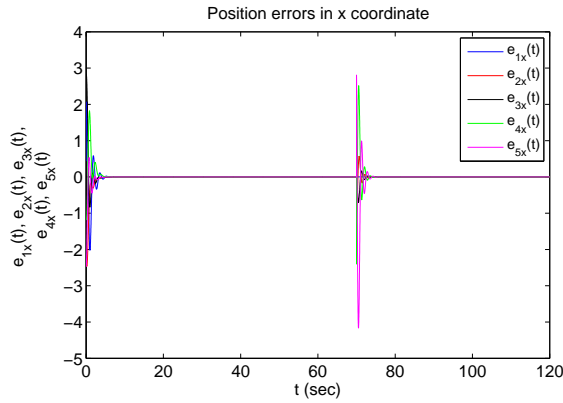

Figure 9. Position errors in  $x$  coordinates with dynamic control algorithm.

The simulation results are depicted in Figures 9–13. In Figures 9–11 one may appreciate the fast response and the exponential convergence of the errors in the absence of disturbances. In the last two figures we illustrate the robustness of the controlled system, subject to the effect



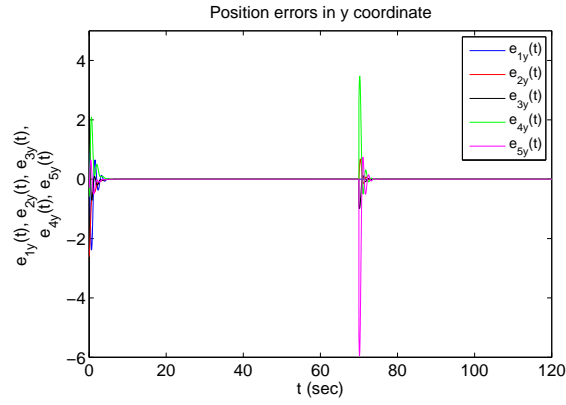

Figure 10. Position errors in  $y$  coordinates with dynamic control algorithm.

of an additive, non-vanishing disturbance acting on the dynamics of  $R_2$ . As expected from the communication topology (spanning tree) and from our main result, the response of the global leader does not change. Because the position errors of the follower robot ( $R_2$ ) converge to a small neighborhood of the origin, the performance of the latter robots are very satisfactory. The effect of the disturbances on the orientation error is null and therefore it is not showed.

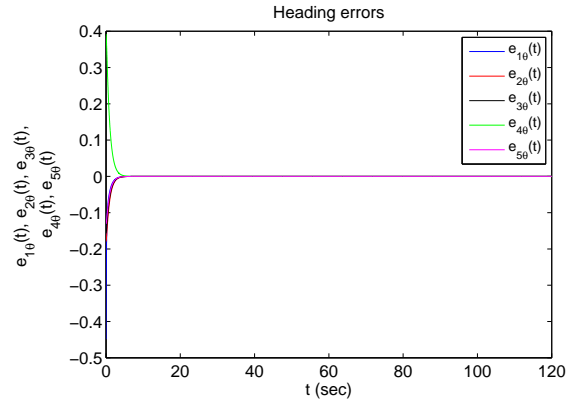

Figure 11. Heading errors with dynamic control algorithm.

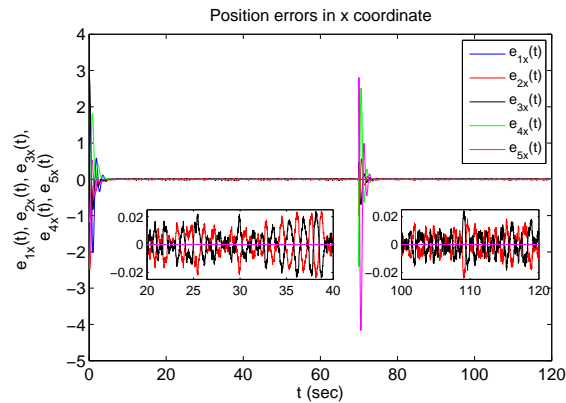

Figure 12. Position errors in  $x$  coordinates with dynamic control algorithm under disturbance.

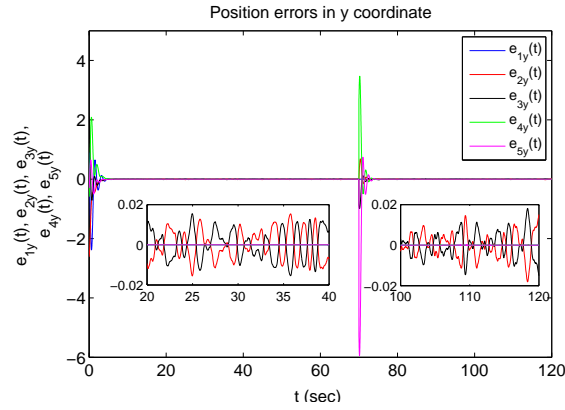

Figure 13. Position errors in  $y$  coordinates with dynamic control algorithm under disturbance.

## 5 Conclusion

We have presented a simple linear controller for formation tracking of a swarm of nonholonomic robots interconnected in a spanning-tree communication configuration. The formation topology is arbitrary and the main assumption is that the angular velocity is persistently exciting. Current work is carried out to extend our results to the case of time-varying topology that is, considering that the interconnections are not constant but time-varying or even state-dependent.

### Acknowledgements

The work of the first author was supported by the Scientific and Technological Research Council of Turkey (TUBITAK) BIDEB under the programme 2219 and was realized while she was on leave at L2S, Supelec, France.

## References

- Balch, T., Arkin, R., 1998. Behavior-based formation control for multirobot teams. *Robotics and Automation, IEEE Transactions on* 14, 926 –939.
- Consolini, L., Morbidi, F., Prattichizzo, D., Tosques, M., 2008. Leader–follower formation control of nonholonomic mobile robots with input constraints. *Automatica* 44, 1343 – 1349.
- Desai, J., Ostrowski, J., Kumar, V., 2001. Modeling and control of formations of nonholonomic mobile robots. *Robotics and Automation, IEEE Transactions on* 17, 905 –908.
- Dierks, T., Brenner, B., Jagannathan, S., 2012. Neural network-based optimal control of mobile robot formations with reduced information exchange. *Control Systems Technology, IEEE Transactions on* PP, 1.
- Dong, W., Guo, Y., Farrell, J., 2006. Formation control of nonholonomic mobile robots, in: *American Control Conference, 2006*, p. 6 pp.
- Fax, J., Murray, R., 2004. Information flow and cooperative control of vehicle formations. *Automatic Control, IEEE Transactions on* 49, 1465 – 1476.
- Fierro, R., Das, A., Kumar, V., Ostrowski, J., 2001. Hybrid control of formations of robots, in: *Robotics and Automation, 2001. Proceedings 2001 ICRA. IEEE International Conference on*, pp. 157 – 162 vol.1.
- Gamage, G., Mann, G., Gosine, R., 2010. Leader follower based formation control strategies for nonholonomic mobile robots: Design, implementation and experimental validation, in: *American Control Conference (ACC), 2010*, pp. 224 –229.
- Ghommam, J., Mehrjerdi, H., Saad, M., 2011. Leader-follower based formation control of non-holonomic robots using the virtual vehicle approach, in: *Mechatronics (ICM), 2011 IEEE International Conference on*, pp. 516 –521.
- Guo, J., Lin, Z., Cao, M., Yan, G., 2010. Adaptive leader-follower formation control for au-

- onomous mobile robots, in: American Control Conference (ACC), 2010, pp. 6822 –6827.
- Jiang, Z.P., Nijmeijer, H., 1997. Tracking control of mobile robots: A case study in backstepping. *Automatica* 33, 1393–1399.
- Kanayama, Y., Kimura, Y., Miyazaki, F., Noguchi, T., 1990. A stable tracking control method for an autonomous mobile robot, in: *Robotics and Automation, 1990. Proceedings., 1990 IEEE International Conference on*, pp. 384 –389 vol.1.
- Lawton, J., Beard, R., Young, B., 2003. A decentralized approach to formation maneuvers. *Robotics and Automation, IEEE Transactions on* 19, 933 – 941.
- Lefeber, A.A.J., 2000. Tracking control of nonlinear mechanical systems. Ph.D. thesis. University of Twente. Enschede, The Netherlands.
- Lewis, M.A., Tan, K.H., 1997. High precision formation control of mobile robots using virtual structures. *Autonomous Robots* 4, 387–403. 10.1023/A:1008814708459.
- LIU, S.C., TAN, D.L., LIU, G.J., 2007. Robust leader-follower formation control of mobile robots based on a second order kinematics model. *Acta Automatica Sinica* 33, 947 – 955.
- Loría A., Panteley, E., 2005. Cascaded nonlinear time-varying systems: analysis and design. Springer Verlag, F. Lamnabhi-Lagarrigue, A. Loría, E. Panteley, eds., London. chapter in *Advanced topics in control systems theory. Lecture Notes in Control and Information Sciences*.
- Narendra, K.S., Annaswamy, A.M., 1989. Stable adaptive systems. Prentice-Hall, Inc., New Jersey.
- Olfati-Saber, R., Murray, R., 2002. Distributed structural stabilization and tracking for formations of dynamic multi-agents, in: *Decision and Control, 2002, Proceedings of the 41st IEEE Conference on*, pp. 209 – 215 vol.1.
- Panteley, E., Lefeber, E., Loría A., Nijmeijer, H., 1998. Exponential tracking of a mobile car using a cascaded approach, in: *IFAC Workshop on Motion Control, Grenoble, France*. pp. 221–226.
- Panteley, E., Loría, A., 2001. Growth rate conditions for stability of cascaded time-varying systems. *Automatica* 37, 453–460.
- Ren, W., Sorensen, N., 2008. Distributed coordination architecture for multi-robot formation control. *Robotics and Autonomous Systems* 56, 324 – 333.
- Sadowska, A., van den Broek, T., Huijberts, H., van de Wouw, N., Kostic, D., Nijmeijer, H., 2011. A virtual structure approach to formation control of unicycle mobile robots using mutual coupling. *Int. J. of Control* 84, 1886–1902. DOI: 10.1080/00207179.2011.627686 .
- Shao, J., Xie, G., Wang, L., 2007. Leader-following formation control of multiple mobile vehicles. *Control Theory Applications, IET* 1, 545 –552.
- Sira-Ramírez, H., Castro-Linares, R., 2010. Trajectory tracking for non-holonomic cars: A linear approach to controlled leader-follower formation, in: *Decision and Control (CDC), 2010 49th IEEE Conference on*, pp. 546 –551.
- Soorki, M., Talebi, H., Nikravesh, S., 2011. A robust dynamic leader-follower formation control with active obstacle avoidance, in: *Systems, Man, and Cybernetics (SMC), 2011 IEEE International Conference on*, pp. 1932 –1937.
- Yoshioko, C., Namerikawa, T., 2008. Formation control of nonholonomic multi-vehicle systems based on virtual structure, in: *17th IFAC World Congress, Seoul, Korea*. pp. 5149–5154. DOI: 10.3182/20080706-5-KR-1001.00865.
- ZHANG, C.M.L., 2010. Consensus control for leader-following multi-agent systems with measurement noises. *Journal of Systems Science and Complexity* 23, 35.

## 6 Appendix

Consider the system (4) where  $x_1 \in \mathbb{R}^n$ ,  $x_2 \in \mathbb{R}^m$ ,  $x \triangleq [x_1 \ x_2]^\top$ . The function  $f_1$  is locally Lipschitz in  $x_1$  uniformly in  $t$  and  $f(\cdot, x_1)$  is continuous,  $f_2$  is continuous and locally Lipschitz in  $x_2$  uniformly in  $t$ ,  $g$  is continuous in  $t$  and once differentiable in  $x$ . The theorem given below

establishes uniform global exponential stability of the cascaded non-autonomous systems.

**Theorem 6.1:** *Let the respective origins of*

$$\Sigma_1 : \dot{x}_1 = f_1(t, x_1) \quad (34)$$

$$\Sigma_2 : \dot{x}_2 = f_2(t, x_2) \quad (35)$$

*be uniformly globally exponentially stable and let the following assumptions hold.*

(A1) *There exist a Lyapunov function  $V : \mathbb{R}_{\geq 0} \times \mathbb{R}^n \rightarrow \mathbb{R}_{\geq 0}$  for (34) which is positive definite, radially unbounded,*

$$\dot{V}(t, x_1) := \frac{\partial V}{\partial t} + \frac{\partial V}{\partial x_1} f_1(t, x_1) \leq 0$$

*and constants  $c_1, c_2, \eta > 0$  such that*

$$\left| \frac{\partial V}{\partial x_1} \right| |x_1| \leq c_1 V(t, x_1) \quad \forall |x_1| \geq \eta \quad (36)$$

$$\left| \frac{\partial V}{\partial x_1} \right| \leq c_2 \quad \forall |x_1| \leq \eta \quad (37)$$

(A2) *There exist two continuous functions  $\theta_1, \theta_2 : \mathbb{R}_{\geq 0} \rightarrow \mathbb{R}_{\geq 0}$  such that  $g(t, x)$  satisfies*

$$|g(t, x)| \leq \theta_1(|x_2|) + \theta_2(|x_2|) |x_1| \quad (38)$$

*Then, the origin of the cascaded system (4) is uniformly globally exponentially stable.*

Note that Assumption A1 holds for quadratic functions; let  $V(t, x_1) := x_1^\top P x_1$  with  $P$  positive definite then

$$\left| \frac{\partial V}{\partial x_1} \right| = |P x_1| \leq \lambda_M(P) |x_1| \leq \lambda_M(P) \quad \forall |x_1| \leq 1$$

while

$$\left| \frac{\partial V}{\partial x_1} \right| |x_1| \leq \lambda_M(P) |x_1|^2 \leq \frac{\lambda_M(P)}{\lambda_m(P)} V(t, x_1) \quad \forall x_1 \in \mathbb{R}^{n_1}.$$

Roughly speaking, Assumption A2 holds if  $g(t, x)$  has linear growth order with respect to  $x_1$ , uniformly in  $t$  for each fixed  $x_2$ .