



HAL
open science

Rheological and thermal study of the curing process of a cycloaliphatic epoxy resin: application to the optimization of the ultimate thermomechanical and electrical properties

Blanca Palomo Losada, Amelia Habas-Ulloa, Pascal Pignolet, Nicolas Quentin, Daniel Fellmann, Jean-Pierre Habas

► To cite this version:

Blanca Palomo Losada, Amelia Habas-Ulloa, Pascal Pignolet, Nicolas Quentin, Daniel Fellmann, et al.. Rheological and thermal study of the curing process of a cycloaliphatic epoxy resin: application to the optimization of the ultimate thermomechanical and electrical properties. *Journal of Physics D: Applied Physics*, 2013, 46 (6), 10.1088/0022-3727/46/6/065301 . hal-00829087

HAL Id: hal-00829087

<https://hal.science/hal-00829087>

Submitted on 1 Jun 2013

HAL is a multi-disciplinary open access archive for the deposit and dissemination of scientific research documents, whether they are published or not. The documents may come from teaching and research institutions in France or abroad, or from public or private research centers.

L'archive ouverte pluridisciplinaire **HAL**, est destinée au dépôt et à la diffusion de documents scientifiques de niveau recherche, publiés ou non, émanant des établissements d'enseignement et de recherche français ou étrangers, des laboratoires publics ou privés.

Rheological and thermal study of the curing process of a cycloaliphatic epoxy resin: application to the optimization of the ultimate thermomechanical and electrical properties

B Palomo¹, A Habas-Ulloa², P Pignolet¹, N Quentin³, D Fellmann³ and J P Habas^{2*}

1 : Universite de Pau & des Pays de l'Adour, SIAME, Equipe Genie Electrique, IPRA, 64053 Pau, FRANCE

2 : Institut Charles Gerhardt, equipe « Ingenierie et Architectures Macromoleculaires », UMR CNRS 5253, CC 1702, Universite de Montpellier 2, Place Eugene Bataillon, 34095 Montpellier, FRANCE

3 : ALSTOM Transport, 50 rue du Docteur Guinier, 65600 Semeac, FRANCE

* : to whom correspondence should be addressed.

Professor Jean-Pierre HABAS

Institut Charles Gerhardt, equipe « Ingenierie et Architectures Macromoleculaires », UMR CNRS 5253, CC 1702, Universite de Montpellier 2, Place Eugene Bataillon, 34095 Montpellier, FRANCE

Mail : jean-pierre.habas@univ-montp2.fr.

Tel: 33-4-67-14-37-80; Fax: 33-4-67-14-40-28

ABSTRACT

The curing process of a cycloaliphatic epoxy resin was defined using different experimental techniques to obtain a material with optimal mechanical and electrical behaviour and with the ultimate objective of its application in the production of polymer-based insulator for railway transportation. The temperature domain characteristic of the crosslinking was determined by differential scanning calorimetry. However, thermogravimetric analyses of the reactive species supported that a low curing temperature had to be chosen during the initial crosslinking stage. Then, kinetic viscoelastic experiments were performed to identify the time and temperature conditions necessary to observe the gelation and vitrification of the reactive mixture. To fulfil higher requirements of productivity and performances, a two-steps thermal cycle was defined and optimized by investigating the influence of different curing schedules on the glass transition temperature of the crosslinked material. The effects of the curing profile

on the dielectric strength of the material were also investigated. Good correlations between the different techniques were observed and explained in term of structure-properties relationships.

Keywords: curing kinetics, epoxy resin, dynamic mechanical properties, dielectric strength, glass transition temperature, activation energy, curing schedule

PACS: 77.84.Jd, 81.05.Lg, 81.40.Tv, 82.35.Lr, 83.80.Jx

1. Introduction

For the last 100 years, ceramic and glass were widely used in outdoor high voltage applications to insure the electrical insulation of various devices. Indeed, both kinds of materials were reputed to offer a good combination of insulating electrical properties with an excellent environmental resistance. Unfortunately, they were also known to present at the same time undeniable drawbacks such as a high density and a mechanical brittleness. The hydrophilic nature of their surfaces was also judged critical because it promoted the initiation of flashover processes. Different studies investigated the properties of other classes of materials. Polymers and derived composites were identified as possible substitution candidates and growingly applied in several electrical devices for energy appliance or railway transportation [1]. Indeed, polymeric insulating materials offered numerous advantages over glass or porcelain [2,3]. Firstly, the lower density of polymers helped for the lightening of insulating structures. Secondly, much less brittle than ceramics, they also made possible the development of insulating structures with enhanced mechanical resistance. Thirdly, some polymeric substrates such as silicone elastomers presented hydrophobic character that was of first importance for outdoor insulating applications. Indeed, it is well known that the moisture diffusion in a dielectric substrate usually induces an alteration of the mechanical and electric properties of the insulating material. In conditions of commercial use, the substrate hydrophobicity also allowed the self-cleaning of the external substrates and made easier the maintenance operations. Ultimately, the manufacture processes for polymer housings appeared more economic due to the use of lower temperatures in comparison with the value required for ceramic or glass fabrication. All these characteristics were valued advantages in railway industry. Logically, this transportation facility promoted the development of polymer-based insulating systems. However, most of the applications were based on the combination of very different polymeric materials (elastomers, thermoplastic or thermoset resins, adhesives...) in order to define the best compromise between physical and chemical properties [4]. But, this multi-layer conception made the production more complex due to the multiplication of the manufacture steps. The equipment reliability also became critical due to the growing number of interfaces between the different materials. All these difficulties encouraged the conception of a new generation of non-ceramic insulators based on a single

polymer that could fulfil the mechanical, electrical and chemical functions originally supported by different materials [5].

Conducted in this scientific framework, our work was to examine the real value offered by a new generation of cycloaliphatic epoxy system said to be moisture-resistant [6]. More precisely, this research aimed to evaluate the ability of this formulation to be used as polymeric matrix for the production of railway insulators for service on train roof. Given the intended application, this polymer formulation is wished to fulfil at the same time structural and electrical functions. In particular, the final material will have to exhibit a high mechanical rigidity at least equal to 1 GPa and for temperature up to 80 °C. In other words, the glass transition temperature of the polymer must be higher than this latter value. The same material must also display a good insulating character. The feedback from experience allowed evaluating that the electrical strength must exceed the value of 20 kV mm⁻¹ considering a sample thickness of 1 mm.

As cycloaliphatic epoxy formulation falls under the category of thermoset materials, the properties of this polymer generation were expected to depend on the time and temperature conditions used during the curing process. Then, the optimization of the polymer network required to be operated before any electrical qualification of the material. As a consequence, our research logically started on the characterization of the crosslinking process.

In the literature, many experimental techniques were already used to study the curing of thermoset materials. Among them, the most practical one is probably the differential scanning calorimetry (DSC). Provided that the exothermicity of the reaction is high enough, it permits a precise determination of the temperature limits of the polymerization domain [7]. The same equipment is also helpful at fixed temperature to investigate the crosslinking kinetic [8-11]. As the curing provokes changes in the polymer chemical structure, Fourier Transform Infra-Red spectroscopy can be regarded as a good complementary technique to evaluate the advancement degree of the crosslinking reaction [12]. But, the interpretation of the chemical data can be difficult when secondary reactions coexist with the main crosslinking scheme. Moreover, the absorbance bands that are affected by the polymerization are closely dependent on the nature of the hardener that is used in association with the epoxy resin [13]. In the case of an amine hardener, the consumption of the N-H units is masked by the increase of the O-H bands due

to the opening of the oxirane group. At the macroscopic scale, viscosimetric experiments are often employed to study the curing mechanism but this technique is inappropriate above the gel point because of the divergence of the mixture viscosity [14-16]. Kinetic rheological experiments conducted in dynamic mode are generally preferred because they are more convenient to investigate the crosslinking process from the liquid to the solid state.

Given this analysis, we adopted a methodology based on the use of different complementary techniques to investigate which combination of time and temperature could permit the manufacture of cured epoxy samples with optimal physical properties for railway service. Differential scanning calorimetry was used to determine the temperature range where the polymerisation of the epoxy mixture produced itself while thermogravimetric experiments were performed to take into account the thermostability of each chemical constituent of the reactive epoxy formulation. Dynamic mechanical measurements were registered as a function of time to analyse the effects of the curing temperature on the polymerisation reaction. The conditions necessary to observe the occurrence of the gelation and vitrification of the resin were studied in detail. The influence of the curing cycle on the thermomechanical and dielectric behaviour of the final material was carefully investigated. We examined more particularly if the values of the glass transition temperature and the dielectric strength could be used as reliable parameters to evaluate the quality of the final polymer network. Actually, previous correlations were already established in literature between the dielectric and rheological behaviour of different epoxy-hardener systems. But, the published works mainly focused on the comparison of the evolution of the dielectric permittivity during the curing step with that characteristic of the shear complex modulus [17-22]. To our knowledge, very few researchers dealt with the changes of the dielectric strength induced by the network formation [23-25].

2. Experimental

2.1. Materials

The epoxy formulation studied in this paper was obtained by the mixing of three components: a cycloaliphatic resin, a hardener and a catalyst. The resin was a diglycidyl ester of hexahydrophthalic acid. The hardener was based in reality on a mixture of two chemical compounds, a hexahydrophthalic anhydride

(70% w/w) and a methyl hexahydrophthalic anhydride (30% w/w). The reaction between the resin and the hardener was catalysed using benzyldimethylamine. All these chemical compounds were kindly furnished by Huntsman Advanced Materials (France). According to this chemical producer, this formulation was less sensitive to moisture than conventional epoxy resins. Then, it seemed well suited to outdoor applications in railway transportation. Using cyclic anhydride hardener also emerged as a good technical option for producing materials with high mechanical properties. The different chemical components were used as received that is to say without any further purification. The hardener was added in stoichiometric proportion to the resin previously heated at the temperature of 50 °C to offer a reduced viscosity. The preparation was mixed under mechanical stirring during 10 min. Then, it was degassed using a vacuum pump during 15 min until disappearance of the air bubbles trapped during the mechanical homogenization. At last, the catalyser was added to the mixture under mechanical agitation. A new degassing operation was undertaken before ultimate use of the reactive mixture.

2.2. Differential scanning calorimetry

Calorimetric experiments were run on a Q100 differential scanning calorimeter (DSC) from TA Instruments® in order to determine the temperature range characteristic of the crosslinking reaction. For the analysis, 10 mg of the non-cured mixture was poured in an aluminium pan that was consecutively placed in the measurement-heating cell while an empty pan was used as reference. All experiments were performed under inert atmosphere (gaseous nitrogen) with a heating rate fixed at 10 °C min⁻¹.

2.3. Thermogravimetric analyses

The thermo-oxidative stabilities of the different chemical species - resin, hardener and catalyst - used in the polymer formulation were examined using a Q50 thermogravimetric analyser (TGA) from TA Instruments®. The experiment consisted in registering the weight loss of the sample as a function of temperature from the ambient up to 550 °C. The temperature ramp was set at 10 °C min⁻¹ and the analysis conducted under air flow (25 mL min⁻¹)

2.4. Dynamical mechanical analyses

2.4.1. Kinetic rheological studies

First rheological experiments consisted in operating kinetic studies of the crosslinking reaction. They were performed using a strain-imposed dynamic rheometer (ARES from Rheometric) equipped with a cup-plate geometry. This fixture that is represented in figure 1a, is suitable for the characterization of an evolutive polymer from the liquid to the solid state. In our study, the inner diameter of the cup was $\phi_{\text{cup}}=25$ mm whilst the upper plate was chosen much smaller ($\phi_{\text{plate}}=5$ mm) to prevent undesirable side effects. The lower element was attached to an actuator that forced an oscillating shear (dynamic mode) whilst the upper plate was attached to a sensor that measured the resulting stress due to the mechanical shearing of the sample.

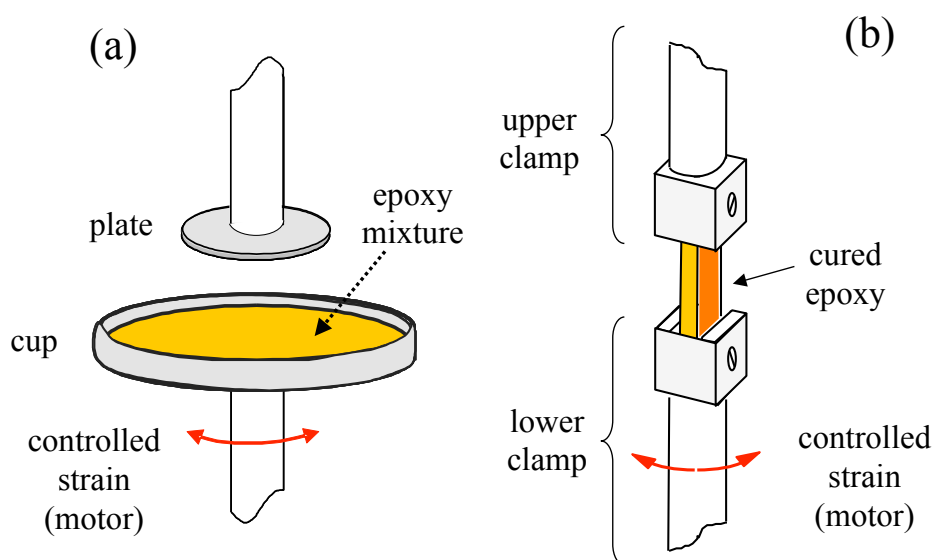

Figure 1. Schematic representation of tools geometry used in rheological tests. (a): cup-plate, (b): rectangular torsion

The rheometer was also equipped with an environmental testing chamber to allow the conduction of measurements under precise control of the temperature. Before the step of the data collection, the following procedure was strictly respected. Firstly, the testing geometry was heated in the rheometer oven at the temperature desired for the future kinetic analysis. Once the thermal equilibrium reached, the epoxy mixture initially liquid was poured into the cup. Then, the upper plate was lowered until contact with the sample. The average gap was about 3 mm. The dynamic experiment was conducted

under constant strain (2%) and fixed angular frequency ($\omega = 1 \text{ rad s}^{-1}$). It consisted in registering the evolution of the complex shear modulus $G^* = G' + j G''$ as a function of curing time in particular to observe and quantify the progressive transformation of the reactive mixture from liquid to solid state. The real component G' is usually called “storage modulus”. It is specific of the elastic contribution of the sample. In other words, it is proportional to the mechanical rigidity of the polymer. The imaginary part G'' is classically named “loss modulus” and relates to the dissipated mechanical energy. When the polymer formulation is in the liquid state, the value of the loss modulus is higher than G' value. In the gel and glassy states, the elastic character is predominant ($G' > G''$).

2.4.2. Thermomechanical analyses

The same rheometer was retained to study the dynamic mechanical behaviour of the cured sample as a function of the temperature. Due to the sample stiffness, the experiment was performed using rectangular torsion geometry (figure 1b). Typical dimensions of the specimens were 45 mm x 10 mm x 1 mm. The thermomechanical tests were carried out at a heating rate of $3 \text{ }^\circ\text{C min}^{-1}$ from the ambient up to $200 \text{ }^\circ\text{C}$. After determination of the domain characteristic of the linear rheology, the strain was set at 0.2 % and the oscillating angular frequency was kept constant ($\omega = 1 \text{ rad s}^{-1}$). At this precise value of angular frequency, the glass transition temperature (T_g) of the polymer can be evaluated at the maximum of G'' peak. This critical temperature was considered as relevant to estimate the density of the polymer network. Indeed, it is currently accepted that the higher the T_g , the denser the polymeric network [26].

2.5. Breakdown voltage measurements

The investigation of the electrical breakdown of epoxy samples under alternative voltage (AC) was carried out in a test vessel containing a pair of parallel-disk electrodes (25 mm diameter) with a Rogowski profile and made of stainless steel. The applied AC high voltage was provided by a 50 kV / 5 kVA / 50 Hz transformer connected to these electrodes. The epoxy sample (80 cm² area and 0.5 mm to 3 mm thickness range) was inserted and pressed between both electrodes. Then, the overall assembly was immersed in FC72 liquid to prevent surface discharge flashovers during the dielectric measurement (figure 2).

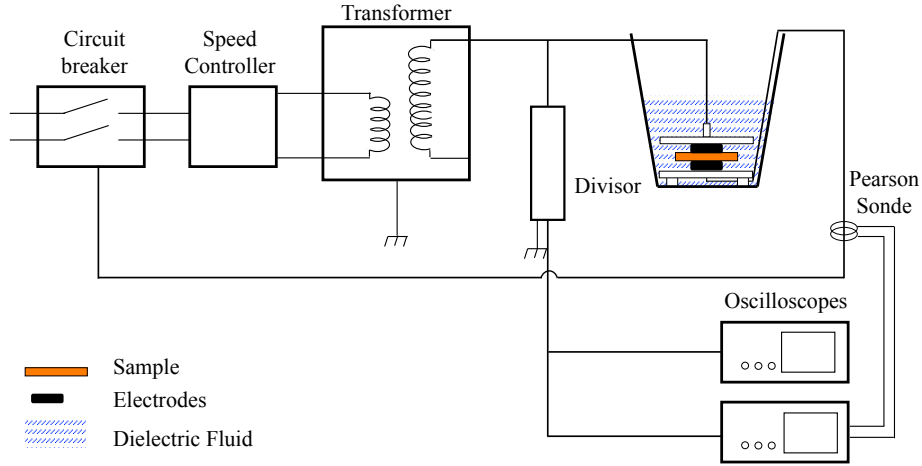

Figure 2. Illustration of the experimental set-up used for breakdown voltage measurements

The measured AC high voltage was applied by means of the step by step method with a voltage increase rate 2 kV s^{-1} . The voltage was measured by means of a compensated capacitor divider ($1/10000$) connected in parallel to the electrode gap and associated to a Tektronix TDS 1002 oscilloscope with a 60MHz frequency band. The transient current was measured at the grounded electrode using a Pearson current probe 4100 (1 V/A matched with 50 Ohm load) connected to a high frequency (400 MHz) Tektronix TDS 380 oscilloscope. This latter was synchronized on the own rise edge of the transient current. The breakdown field E_i was calculated from the ratio of the measured breakdown voltage $V_{bc}(i)$ at the disruption instant on the thickness of the sample d_i at the location of the arc path according Equation 1:

$$E_i = \frac{V_{bc}(i)}{d_i} \quad (\text{Eq. 1})$$

The dielectric strength was deduced from the distribution in breakdown voltages obtained for a set of at least five samples of similar thickness. The experimental results were treated using a Weibull statistical distribution [27,28]. This approach consists in considering that experimental value of the dielectric strength E_i is characterized by a probability $P(E_i)$ that is calculated and ordered from the smallest to the highest value using Bernard's formula:

$$P(E_i) = \frac{N_i - 0.3}{N_{\max} + 0.4} \quad (\text{Eq. 2})$$

where N_{max} is the total number of measurements for each series (here $N_{max} = 5$) and N_i is the reference of the measurement in the series ($1 \leq N_i \leq N_{max}$).

The dielectric strength E_i is related to its probability $P(E_i)$ according the Equation 3:

$$P(E_i) = 1 - \exp\left[-\left(\frac{E_i}{\alpha}\right)^\beta\right] \quad (\text{Eq. 3})$$

This latter relationship can be rewritten according Equation 4 what allows the determination of the values of the parameters α and β by linear fit

$$Y(E_i) = \ln\left[\ln\left(\frac{1}{1-P(E_i)}\right)\right] = \beta \ln(E_i) - \beta \ln(\alpha) \quad (\text{Eq. 4})$$

The dielectric rigidity characteristic of the material E_i is given by $E_i = \alpha$ what corresponds to a probability $P(E_i) = 0.632$.

3. Results and discussion

3.1. Calorimetric results

Figure 3 depicts the DSC results of the non-isothermal curing of the reactive epoxy mixture in the temperature zone ranging from 30 °C to 250 °C. One can note the presence of a broad exothermic peak from 50 °C up to 250 °C and with a maximum at $T = 160$ °C.

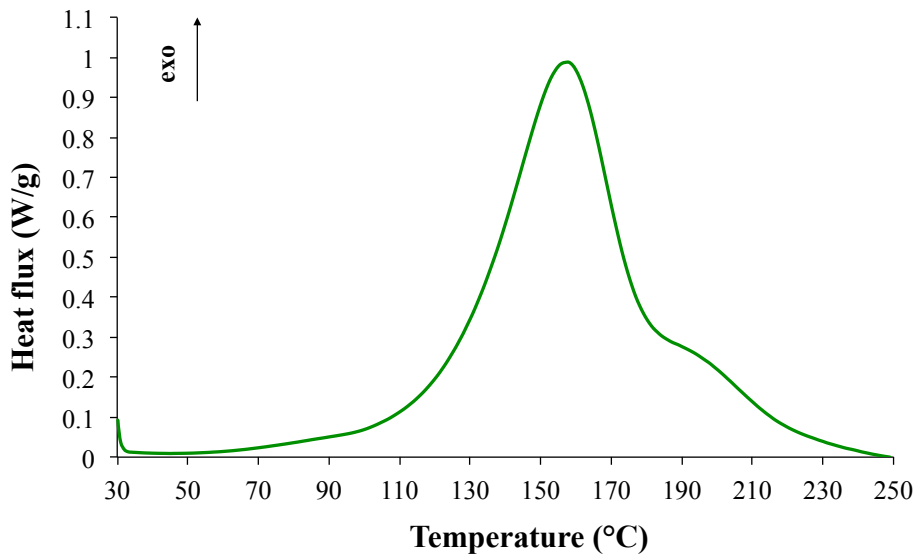

Figure 3. Dynamic DSC analysis of the epoxy/hardener/catalyst system (10 °C min^{-1})

This phenomenon defines the temperature zone where the crosslinking reaction occurs. In other words, the minimal temperature T_{min} required for the crosslinking process is about 50 °C whereas the reaction seems to be achieved for $T > 250$ °C. The presence of a small shoulder centred at $T = 195$ °C is likely due to secondary reactions that occur in addition of the main reaction scheme. The value of the overall reaction enthalpy ΔH reduced to the weight sample can be calculated from the area of the exothermic peak and is evaluated to be close to 300 J g⁻¹. This value is in good agreement with the values classically observed with epoxyde formulations based on anhydride hardener [29,30].

3.2. Thermogravimetric data

As the crosslinking reaction produces itself at high temperature, it is important to evaluate the thermostability of each elementary chemical species involved in the reaction. Then, TGA experiments were conducted on all chemical components present in the epoxy mixture. The results of the different analyses are detailed in figure 4.

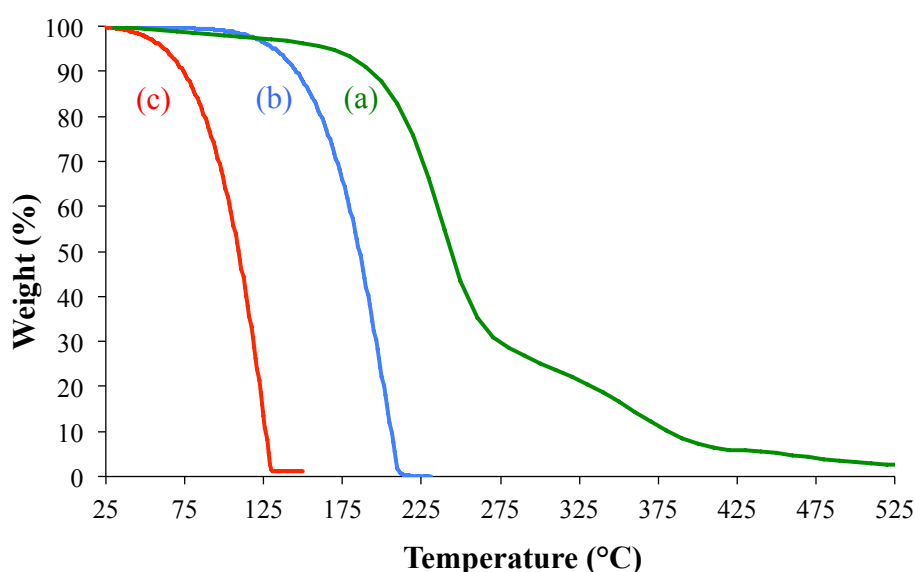

Figure 4. Thermogravimetric curves of the resin (a), hardener (b) and catalyst (c) with a heating rate of 10 °C min⁻¹.

They reveal that the smallest degradation/evaporation temperature is specific of the catalyst. This information seems logical since this chemical specie is characterized by a very low molecular mass. Then, to allow its catalytic action in the polymerization of our epoxy system, a low curing temperature

must be preferred at least during the initial crosslinking stage. For this reason, the study of the kinetic rheological experiments was reduced to the temperature domain ranging from 50 °C up to 100 °C. According the calorimetric data previously described, this thermal zone corresponds to the first part of the endothermic peak. In this “low temperature” domain, the crosslinking process operates itself at a lower rate than at high temperature. At the same time, this polymerization condition is likely to be more favourable for the production of a good quality network [31].

3.3. Kinetic rheological analyses

Two kinds of kinetic rheological profiles were observed depending on the curing temperature used during the analysis. The first one was obtained for $50\text{ °C} < T < 65\text{ °C}$ while the other one was registered with higher curing temperatures. Figure 5 presents an example of a kinetic characteristic of the first situation. More particularly, it shows the results of the rheological analysis of the reactive epoxy system conducted at $T = 50\text{ °C}$ that is to say at a temperature located at the beginning of the crosslinking zone.

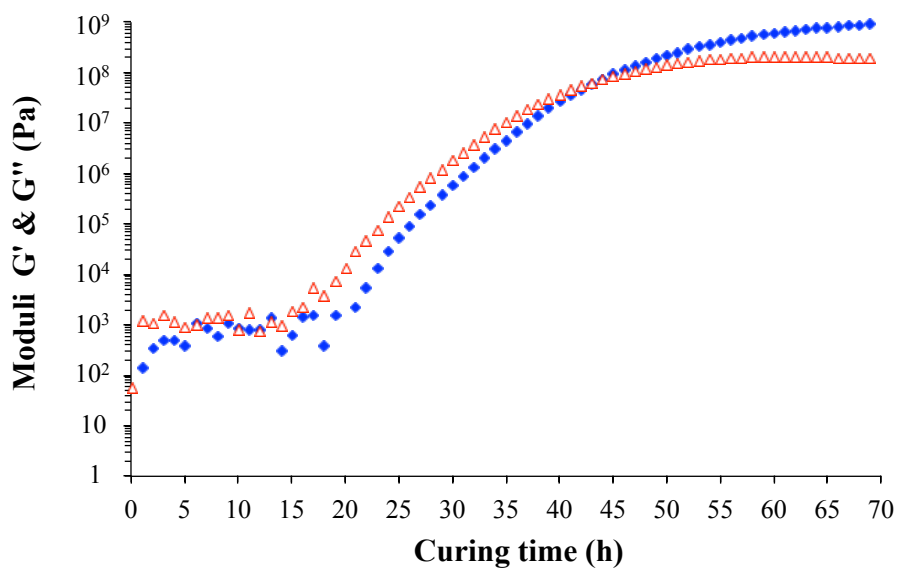

Figure 5. Kinetic rheological analysis of the epoxy system at $T = 50\text{ °C}$ with $\omega = 10\text{ rad s}^{-1}$. G' (◆) and G'' (Δ)

In the first period of the analysis, the epoxy mixture is in the liquid state: the values of G' and G'' moduli remain weak and even random due to the low value of the torque measured by the rheometer sensor. Then, for time t higher than 15 hours, the values of both moduli continuously increase and the

elastic character becomes predominant for $t > 42$ h ($G' > G''$). Finally, both curves tend to limit values when t exceeds 55 h ($G' \sim 10^9$ Pa and $G'' \sim 10^8$ Pa). In this latter stage, the epoxy mixture is in the glassy state. This whole evolution is provoked by the crosslinking reaction that produces the formation of molecular species with growing weight and decreasing mobility. At the macroscopic scale, both material's T_g and mechanical rigidity continuously increase. But, when the polymer T_g overpasses the temperature used for the kinetic analysis, the vitrification of the material is observed. Then, the crosslinking reaction is stopped even if all the reactive components are not consumed.

Figure 6 depicts the typical evolution of the rheological properties of the epoxy mixture when the kinetic study is undertaken for $T > 65$ °C. It shows more particularly the data registered at $T = 80$ °C. At first sight, the evolution of the viscoelastic properties of the epoxy formulation with time seems to be similar to that described before at 50 °C. Indeed, the crosslinking process promotes once more the increase of the moduli values. But, a more careful examination of the rheological data reveals the presence of an intermediate step between the liquid and glassy state where the G' and G'' curves intersect and present later an inflexion.

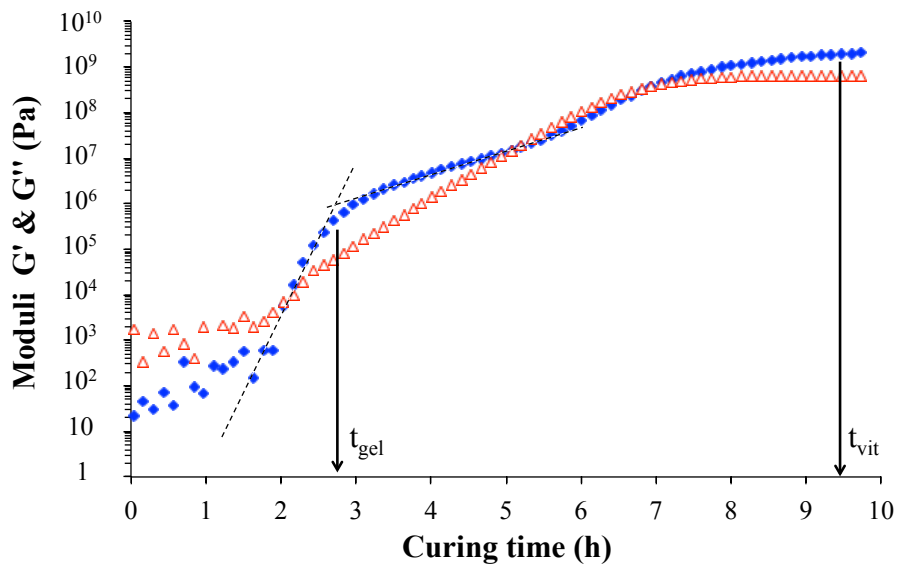

Figure 6. Illustration of the determination of the gel and vitrification times on the kinetic rheological analysis of the epoxy system at $T = 80$ °C with $\omega = 10$ rad s⁻¹. G' (◆) and G'' (Δ).

This intermediary phenomenon is characteristic of the material gelation. Associated to the formation of a 3-dimensional macromolecule with a size that is at least equal to one of the macroscopic dimension of

the sample, the description of the gelation stage is quite important in thermoset polymers because it makes possible the production of a cured resin with higher mechanical properties. In other words, a thermoset polymer that undergoes the direct transition from the liquid to the glassy state without intermediate gelation as observed for $T = 50\text{ °C}$ is rigid but much brittle.

The conduction of other rheological kinetic studies at different constant temperatures comprised between 70 °C and 100 °C shows that in this temperature range, all curves exhibit the gelation stage (figure 7). Both gelation and vitrification phenomena appear sooner when the temperature used for the kinetic analysis is increased.

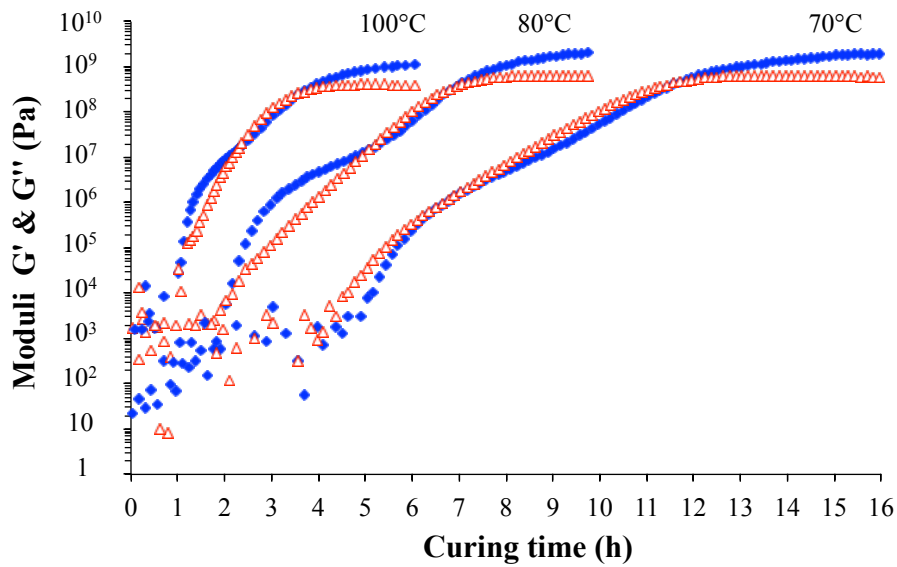

Figure 7. Influence of the curing temperature upon the evolution of the viscoelastic properties of the epoxy formulation as a function of time ($\omega = 10\text{ rad s}^{-1}$) for $T > 65\text{ °C}$

To evaluate the effects of the temperature on the gelation and vitrification processes, we defined two characteristic times for each rheological kinetic registered for $T > 65\text{ °C}$. The first one, taken down in the inflexion zone where the tangents of the G' curve intersect is used to characterize the gelation step at a given temperature. It slightly overestimates the exact value of the gel time t_{gel} but it presents the advantage to be determined in an easier way than by the method that requires the conduction of several experiments at different shearing frequencies [32]. The time t_{vit} necessary for the epoxy mixture to reach the glassy state is taken at the first point where the elastic modulus becomes nearly stable (see the

illustration on Figure 6). The evolution of the logarithmic values of t_{gel} and t_{vit} according the reverse of the absolute temperature is represented in figure 8.

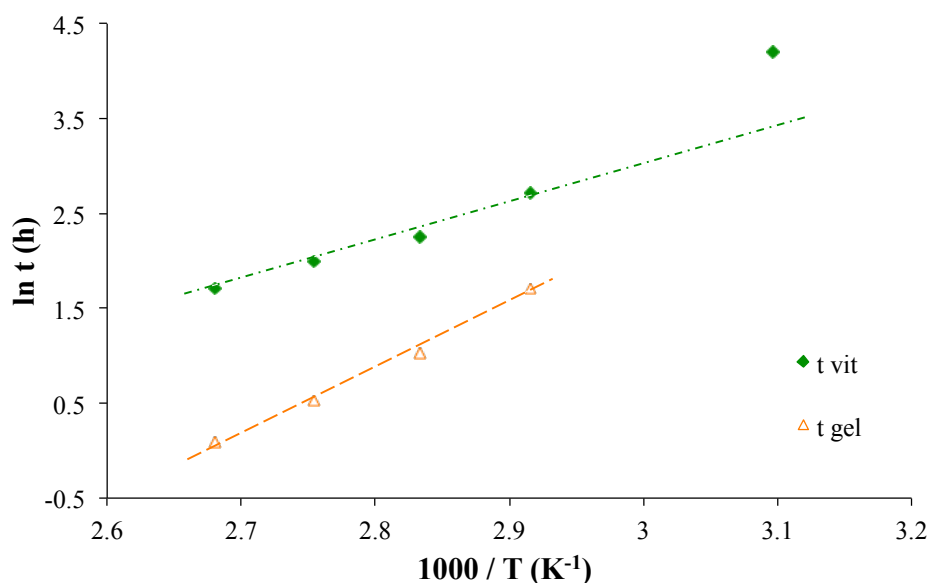

Figure 8. Representation of the evolution of the logarithmic values of the transition times t_{gel} and t_{vit} according the reverse of the absolute temperature.

At the curing temperature of 50 °C, the only critical time that can be reported on the previous graph is relative to the direct transition from the liquid to the glassy state. However, the corresponding point is notably far away from the extrapolation of the Arrhenius dependence of the vitrification time versus temperature. This deviation confirms that at the curing temperature of 50 °C, the macromolecular system is characterized by a conversion rate and morphology that are really different than that observed at higher temperatures.

The data obtained from the kinetics demonstrate that the curing temperature should be set at a temperature at least equal to 70 °C to get a cured material with a good mechanical properties. Nevertheless, at this minimum temperature, the time necessary for the epoxy mixture to reach the glassy state is excessively long what does not fit with the requirement of industrial productivity. Inversely, the crosslinking process should not be undertaken at a temperature at the vicinity of 100 °C because this latter value is too close to the thermal zone where the catalyst degradation produces itself. The best compromise seems to be encountered with a curing temperature comprised between 80 °C and 90 °C. To discriminate the influence of each limit temperature upon the final quality of the cured polymer, several

samples were prepared with variable curing times either at 80 °C or 90 °C. Then, their thermomechanical behaviour was investigated in order to evaluate the consequences on the polymer glass transition as a function of the curing time. Indeed, this critical temperature is an excellent criterion for evaluating the overall quality of a polymer network.

3.4. Dynamic mechanical study of cured epoxy

The first thermomechanical results presented in figure 9 are characteristic of the polymer formulation after curing at 80 °C during 7 h. This analysis shows that the resulting material is in the glassy state for temperature up to 50 °C [33]. However, the value of the storage modulus G' is about 0.2 GPa what remains relatively weak for a vitreous material. Then, for a temperature comprised between 50 °C and 85 °C, the G' curve shows a deflection and at the same time, the G'' curve presents a relaxation peak. Both phenomena are characteristic of the glass transition of the polymer. Due to the low value of the angular frequency used for the rheological test, the temperature $T\alpha$ taken at the maximum of this peak gives a reliable evaluation of the glass transition temperature of the cured epoxy ($T_g = 59$ °C). Finally, the rubbery state of the material is observed for $T > 85$ °C.

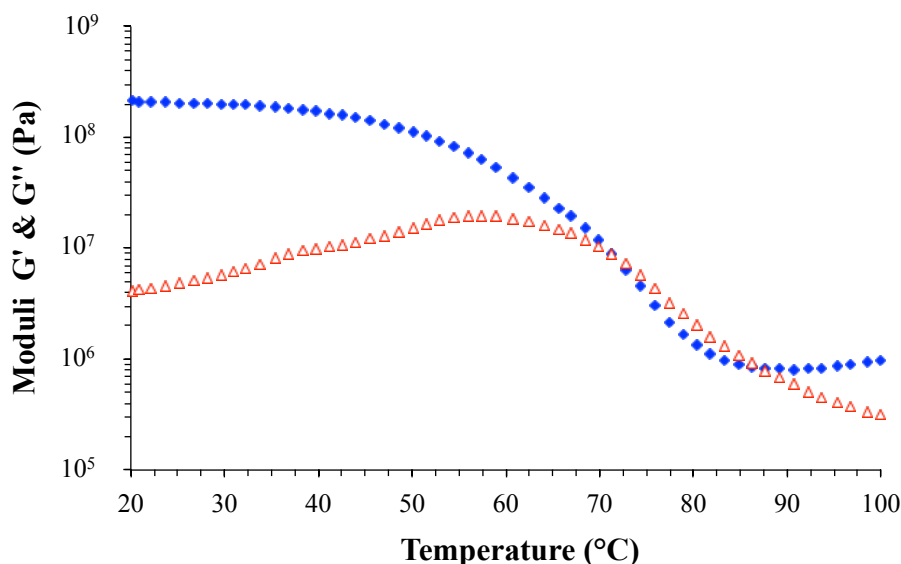

Figure 9. Thermomechanical behaviour of the epoxy mixture after 7 h of curing at 80 °C. G' (◆) and G'' (Δ).

According to the results of the kinetic studies, the curing of the epoxy mixture at 80 °C requires a minimal time of 10 h to achieve the crosslinking reaction at this temperature. This means that the analysis presented in figure 9 is specific of a polymeric formulation that is not fully cured. Logically, samples cured at the same temperature but during larger periods should present higher T_g values. This evolution is clearly shown in figure 10 that depicts the influence of the curing time on the polymer T_g at two specific polymerization temperatures ($T = 80$ °C and $T = 90$ °C). In both cases, the T_g value increases in the first times of the curing and finally tends towards a limit value.

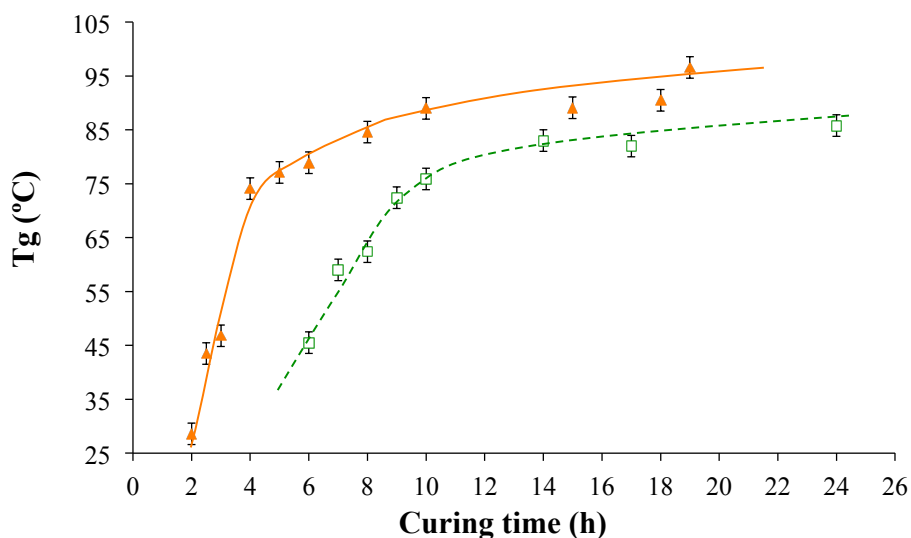

Figure 10. Evolution of the polymer T_g as a function of the curing time and at two different polymerisation temperatures (\square : $T = 80$ °C; \blacktriangle : $T = 90$ °C)

These data also reveal that the curing of the epoxy mixture at 90 °C requires a minimal time of 8 h to make it possible the achievement of the crosslinking reaction whereas the reaction seems to be stopped for $t > 12$ h at 80 °C. Nevertheless, whatever the case described, the limit value is just sufficient as regards the requirement of the industrial appliance ($T_g > 75$ °C). For this reason, a new curing cycle based on two steps was investigated to produce crosslinked samples with higher performances [34]. Due to the real influence of the gelation upon the quality of the crosslinked material, the first step was based on a “time/temperature” couple chosen to insure the description of this transition. Previous kinetics showed that at $T = 80$ °C, the gelation time is about 3 hours while it is close to 2 h at $T = 90$ °C. The second stage of the curing cycle is conducted at a higher temperature T_2 to allow the achievement of the crosslinking reaction. Figure 11 presents as an example the results of the rheological analysis get by

following the curing cycle based on a first step set at $T_1 = 80\text{ °C}$ during 3 hours and a second stage $T_2 = 140\text{ °C}$.

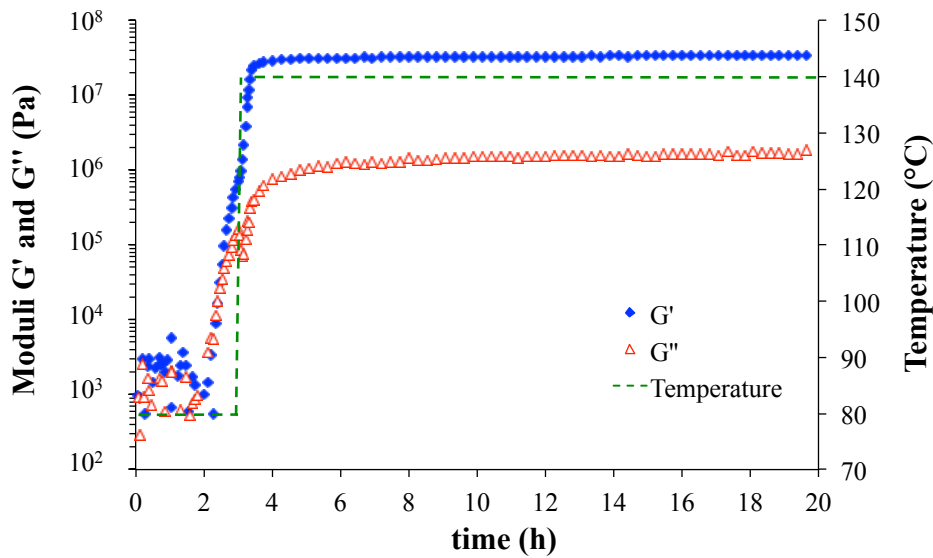

Figure 11. Typical kinetic rheological behaviour of the reactive epoxy formulation submitted to a two-steps curing cycle: $T_1 = 80\text{ °C}$; $t_1 = 3\text{ h}$ followed by $T_2 = 140\text{ °C}$; $t_2 = 17\text{ h}$.

At the end of the first stage, the sudden increase of the temperature from T_1 up to T_2 provokes a slight decrease of the G'' modulus. Afterwards, the acceleration of the crosslinking process induces a rapid enhancement of both moduli. The limit behaviour seems to be reached for $t > 8\text{ h}$. To evaluate in another way the effects of the second stage on the final properties of the crosslinked epoxy, several samples were cured according a same first stage (3h at 80 °C) but with different periods t_2 at T_2 . Then, their thermomechanical behaviours were investigated using dynamic rheometry. One example of typical response is proposed in figure 12. It corresponds to an epoxy formulation submitted to a curing first step of 3 h at 80 °C followed by a second stage of 8 h at 140 °C . The value of the material T_g is evaluated to be close to 97 °C while the value of the glassy modulus is much higher than that previously described in figure 9. The use of a two-steps curing cycle seems already interesting to improve the thermomechanical performances of the cured material.

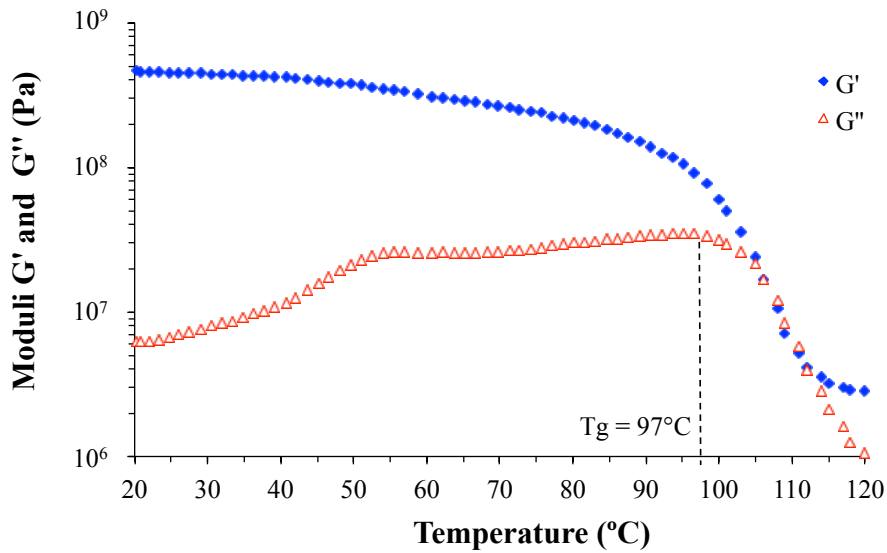

Figure 12. Thermomechanical analysis of the epoxy after a 2-steps curing at 80 °C during 3 h followed by 8 h at 140 °C.

Actually, the plot of the evolution of the material T_g versus the couple of parameters (t_2 , T_2) shows that the previous case corresponds to the best option (figure 13). In addition, this time-temperature combination leads to a material that is able to fulfil the industrial target ($T_g > 75$ °C). At the same time, it is interesting to note that at the curing temperature of 140 °C, a slight decrease of T_g can be observed for $t_2 > 8$ h.

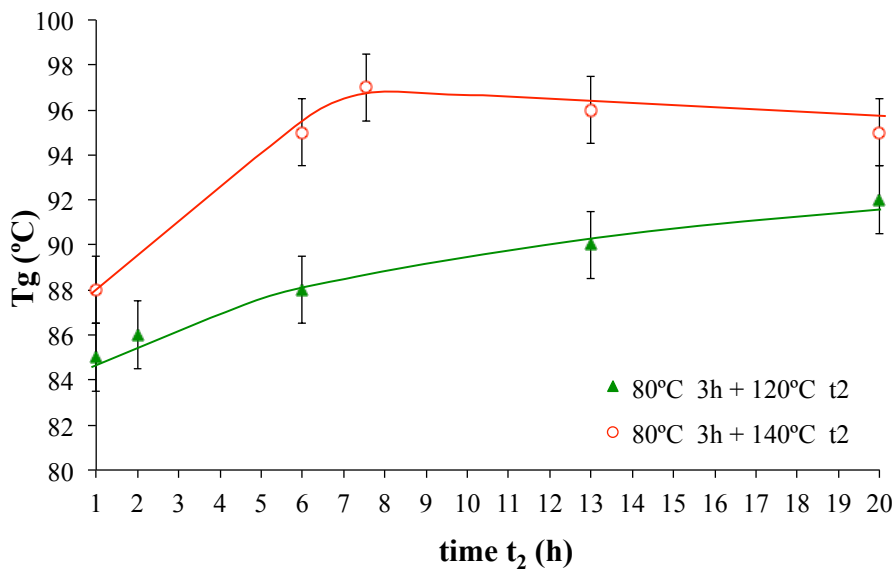

Figure 13. Evolution of the polymer T_g with the parameters (t_2 , T_2) associated to the second stage (○: $T_2 = 140$ °C; ▲: $T_2 = 120$ °C)

This latter phenomenon is likely related to the possible degradation of the polymer due to an excessive exposure to high temperature. In other words, the pursuing of the curing on very long times does not always induce the improvement of the material properties.

3.5. Investigation of the dielectric strength of cured epoxy

It is important to remember that the optimization of the crosslinking of the cycloaliphatic formulation previously presented was investigated to produce a material with a high T_g to fulfil the thermal and mechanical requirements of the future industrial application. As the wished equipment (railway insulator) must also present very good electrical insulating properties (i.e. a dielectric strength $E > 20$ kV mm⁻¹ for a thickness of 1 mm), it is important to evaluate what are the consequences of the crosslinking optimisation on the electrical performances of the material.

For this purpose, four sample series were prepared by keeping constant the conditions associated to the first step (3 h at 80 °C) but by varying the temperature or the duration of the last step. Then, the influence of the characteristic of the time-temperature profile was investigated on the value of the cured epoxy dielectric strength. First of all, the data presented in table 1 are in the same range of order than the values proposed in the literature for this class of material [35]. A more careful examination reveals that the curing cycle has a significant influence on the value of the epoxy dielectric strength. Indeed, The lowest dielectric strength is observed with the epoxy that is characterized by the lowest T_g value (cycle D). Inversely, the highest insulating character is obtained with the sample cured according the optimal cycle (referenced as A). Considering the industrial requirement, the corresponding value of E offers an acceptable security margin. Moreover, as regards our own results, it is interesting to note that an excessive curing at 140 °C provokes at the same time the reduction of the polymer T_g and its dielectric performances. All these evolutions seem to show that both rheological properties and dielectric characteristics of a thermoset polymer are strongly dependent on the curing conditions. In other words, these macroscopic physical properties are closely related to the quality of the polymer network. This result can be explained considering that an increase of the crosslinking degree induces a reduction of dangling chains in the macromolecular network. Then, its polar character is reduced which

could help to shift the initiation and the propagation of the electrical arcing to highest values of the applied electrical field [36,37].

Table 1. Influence of the curing schedule on the epoxy dielectric strength (thickness = 1 mm)

Cycle	Curing conditions in the second step	E (kV mm ⁻¹)	T_g (°C)
A	$T_2 = 140$ °C, $t_2 = 8$ h	29 ± 1	97
B	$T_2 = 140$ °C, $t_2 = 10$ h	27 ± 1	96
C	$T_2 = 140$ °C, $t_2 = 20$ h	25 ± 1	94
D	$T_2 = 120$ °C, $t_2 = 9$ h	22 ± 1	88

Finally, as the dielectric strength is known to be dependent on the thickness of the sample, the previous measurements need to be completed by the conduction of electrical tests [38-41]. These experiments were performed on new series of epoxy samples with thickness d comprised between 0.5 mm and 3 mm but cured according to the same optimal cycle. Each thickness is represented by a series of at least five samples. Figure 14 presents the results of the dielectric tests performed on these samples. It shows clearly that the dielectric strength of the cured epoxy is significantly reduced by an increase of the sample thickness according a power law. The negative exponent (-0.44) is close to that proposed in literature [42,43]. This evolution is usually explained by the fact that a higher thickness provokes a higher probability of defects presence (bubbles, microcracks...) in the polymer bulk what contributes to a reduction of the dielectric strength [44,45]. Nevertheless, this situation remains acceptable in the framework of the future industrial application because the withstand voltage increases with the thickness of the sample.

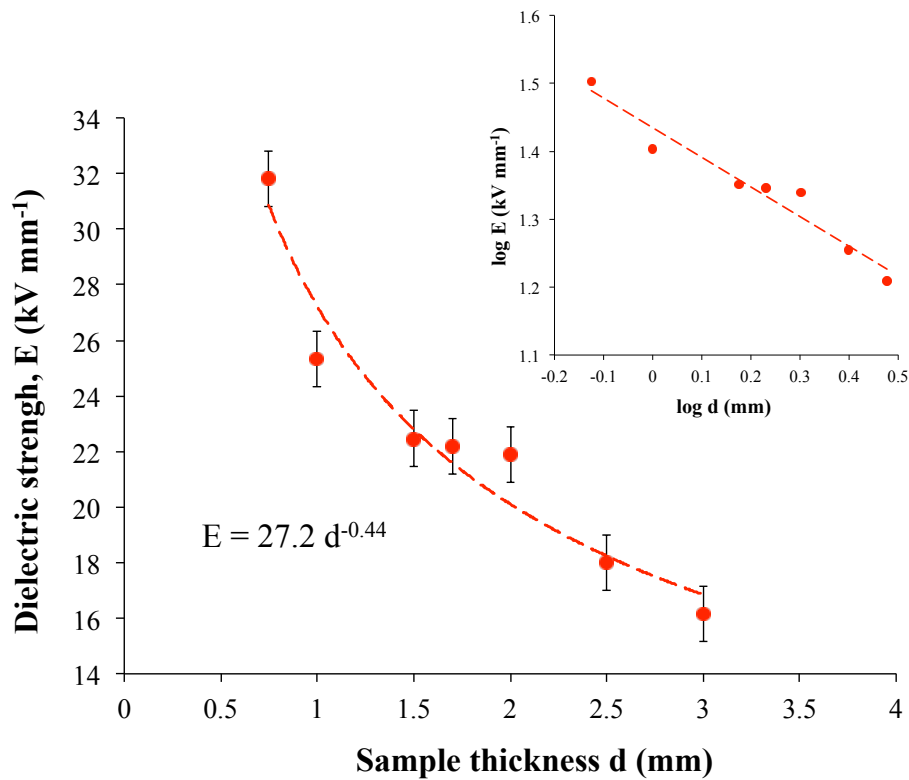

Figure 14. Influence of sample thickness on the dielectric strength of the epoxy sample after curing according the optimal thermal cycle.

4. Conclusions

This work aimed to examine the possible application of a cycloaliphatic epoxy formulation as matrix polymer for the manufacture of insulators for railway transportation. Due to the thermosetting nature of the polymer, the properties of the ultimate material were suspected to be strongly dependent of the time and temperature used during the curing cycle. Finally, our results showed that a gradual scientific methodology based on different experimental techniques was really helpful to define the best conditions for the curing of the resin. The temperature domain characteristic of the crosslinking reaction could be easily determined by calorimetry. The conduction of kinetic rheological experiments gave information of much higher importance. Indeed, while the vitrification of the material was observed for each temperature studied, the resin gelation produced itself only beyond precise conditions of time and temperature. In the framework of our industrial application, a two-steps curing cycle was judged as necessary to fulfil productivity requirements. The time and temperature related to the first stage were chosen so as to make possible the polymer gelation as this phenomenon is indispensable for the production of a cured material of good quality. Then, the characteristics of the second stage were defined by the conduction of thermomechanical analyses and dielectric

measurements. Indeed, the crosslink density of the resin influenced both glass transition temperature and dielectric strength of the final material. More precisely, an interesting correlation between viscoelastic and electrical tests was established since the best corresponding properties were obtained for the same curing cycle. In this latter case, the performances of the cured resin agree with the thermomechanical and electrical specifications required by the industrial application. In other words, this epoxy formulation cured 3 h at 80 °C followed by 8 h at 140 °C produces a rigid dielectric substrate that seems suitable for application in railway insulator. Nevertheless, before production, the conduction of new experiments is absolutely necessary to investigate the durability of the cured material in conditions close to that encountered in the future industrial service. Considering the environment of a railway outdoor insulator, aging tests will be scheduled to examine the influence of moisture, temperature and UV on the physicochemical properties of the resin prepared according to the curing cycle defined in this paper.

Acknowledgments

The authors are really grateful to the Agence Nationale de la Recherche et de la Technologie for financial support (CIFRE grant 1184/2007).

References

- [1] Hall JF 1993 History and bibliography of polymeric insulators for outdoor applications *IEEE Trans. on Power Deliv.* **8** 376-385
- [2] Mackevich J and Shah M 1997 Polymer outdoor insulating materials Part I: comparison of porcelain and polymer electrical insulation *Elect. Insul. Mag.* **13** (3) 5-12
- [3] Hillborg H and Gedde UW 2001 Hydrophobicity changes in silicone rubbers *IEEE Trans. Dielect. and Elect. Insul.* **6** 703-717 (2001)
- [4] Looms JST 1988 *Insulators for high voltage* (London : Inst. of Eng. and Technol.)
- [5] Gorur RS and Montesinos J 2000 Electrical performance of cycloaliphatic epoxy materials and insulators for outdoor use *IEEE Trans. on Power Deliv.* **15** (4) 1274-1278
- [6] Beisele C and Kultzow B 2001 Experiences with new hydrophobic cycloaliphatic epoxy outdoor insulation systems *IEEE Insul. Mag.* **17** (4) 33-39
- [7] Um MK, Daniel IM and Hwang BS 2002 A study of cure kinetics by the use of dynamic differential scanning calorimetry *Comp. Sci. and Technol.* **62** 29-40
- [8] Montserrat S, Flaqué C, Calafell M, Andreu G and Malek J 1995 Influence of the accelerator concentration on the curing reaction of an epoxy-anhydride system *Thermochimica Acta* **269** 213-229
- [9] Omrani A, Simon LC, Rostami AA and Ghaemy M 2007 Cure kinetics, dynamic mechanical and morphological properties of epoxy resin-Im₆NiBr₂ system *Eur. Polym. J.* **44** 769-779
- [10] Costa ML, Botelho EC and Rezende MC 2006 Monitoring of cure kinetic prepreg and cure cycle modelling *J. of Mater. Sci* **41** (13) 4349-4356
- [11] Ghaemy M and Riahy MH 1996 Kinetics of anhydride and polyamide curing of bisphenol A-based diglycidyl ether using DSC *Eur. Polym. J.* **32** (10) 1207-1212
- [12] Achilias DS, Karabela MM, Varkopoulou EA and Sideridou ID 2012 Cure kinetics study of two epoxy systems with Fourier transform infrared spectroscopy (FTIR) and differential scanning calorimetry (DSC) *J. of Macromol. Sci. Part A-Pure and Appl. Chem.* **49** (8) 630-638
- [13] Canavate J, Colom X, Pages P and Carrasco F 2000 Study of the curing process of an epoxy resin by FTIR spectroscopy *Polym. Plast. Technol. and Eng.* **39** (5) 937-943

- [14] Nassiet V, Habas JP, Hassoune-Rhabbour B, Baziard Y and Petit JA 2006 Correlation between viscoelastic behaviour and cooling stresses in a cured epoxy resin system” *J. of Appl. Polym. Sci.* **5** 679-690
- [15] Boey FYC and Qiang W 2000 Determining the gel point of an epoxy-hexa-anhydro-4-methylphthalic anhydride (MHHPA) system” *J. of Appl. Polym. Sci.* **76** 1248-1256
- [16] Eloundou JP, Ayina O and Ngamveng JO 1998 Etude comparée de deux systèmes epoxy-amine par rhéologie au voisinage du point de gel *Eur. Polym. J.* **34**, 1331-1340
- [17] Delmotte M, Jullien H and Ollivon M 1991 Variations of the dielectric properties of epoxy resins during microwave curing *Eur. Polym. J.* **27** (4) 371-376
- [18] Boiteux G, Dublineau P, Feve M, Mathieu C, Seytre G and Ulanski 1993 J Dielectric and viscoelastic studies of curing epoxy-amine model systems *Polym. Bull.* **30** (4) 441-447
- [19] Challis RE, Unwin ME, Chadwick DL, Freemantle RJ, Partridge IK, Dare DJ and Karkanis PI 2003 Following network formation in an epoxy/amine system by ultrasound, dielectric, and nuclear magnetic resonance measurements: a comparative study *J. of Appl. Polym. Sci.* **88** (7) 1665-1675
- [20] Kortaberria G, Solar L, Jimeno A, Arruti P, Gomez C and Mondragon I 2006 Curing of an epoxy resin modified with nanoclay monitored by dielectric spectroscopy and rheological measurements *J. of Appl. Polym. Sci.* **102** (6) 5927-5933
- [21] Shigue CY, dos Santos RGS, Baldan CA and Ruppert E 2004 Monitoring the epoxy curing by the dielectric thermal analysis method *IEEE Trans. on Appl. Supercond.* **14** (2) 1173-1176
- [22] Nixdorf K and Busse G 2001 The dielectric properties of glass-fibre-reinforced epoxy resin during polymerisation *Comp Sci. and Technol.* **61**(6) 889-894
- [23] Rakshit, PB, Jain RC, Shah SR and Shrinet V 2011 Synthesis and characterization of cycloaromatic polyamines to cure epoxy resin for industrial applications *Polym. Plast. Technol. and Eng.* **50** (7) 674-680
- [24] Goswami DN and Shravan K 1988 Study on the curing of shellac with epoxy and phenolic resins by the measurement of dielectric strength *Pigment & Resin Technol.* **17** (2) 4-6

- [25] Vouyovitch L, Alberola ND, Flandin L, Beroual A and Bessede JL 2006 Dielectric breakdown of epoxy-based composites: Relative influence of physical and chemical aging *IEEE Trans. Dielect. and Elect. Insul.* **13** (2) 282-292
- [26] Bicerano J 2002 Prediction of polymer properties (New York: 3rd edition MarcelDekker), pp 169–260
- [27] Hill RM and Dissado 1983 Theoretical basis for the statistics of dielectric-breakdown *J. of Phys. C: Solid State Phys.* **16** (11) 2145-2156
- [28] Montanari GC, Mazzanti G and Simoni L 2002 Progress in electrothermal life modeling of electrical insulation during the last decades *IEEE Trans. Dielect. and Elect. Insul.* **9** (5) 730-745
- [29] Jain R, Choudhary V and Narula AK 2007 Curing and thermal behavior of DGEBA in presence of dianhydrides and aromatic diamine *J. of Appl. Polym. Sci.* **105** (6) 3804-3808
- [30] Harsch M, Karger-Kocsis J and Holst M 2007 Influence of fillers and additives on the cure kinetics of an epoxy/anhydride resin *Eur. Polym. J.* **43** (4) 1168-1178
- [31] Pascault JP 2002 Thermosetting Polymers (New York : Marcel Dekker) pp 119-144
- [32] Winter HH 1987 Can the gel point of a cross-linking polymer be detected by the $G' - G''$ crossover? *Polym. Eng. and Sci.* **27** 1698-1702
- [33] Murayama T and Bell JP 1970 Relation between the network structure and dynamic mechanical properties of a typical amine-cured epoxy polymer *J. Polym. Sci. Part A-2* **8**, 437-445
- [34] Grillet AC, Galy J and Pascault JP 1992 Influence of a 2-step process and of different cure schedules on the generated morphology of a rubber-modified epoxy system based on aromatic diamines *Polymer* **33** (1) 34-43
- [35] Bardonnnet P 1992 Résines époxydes : composants et propriétés *Techniques de l'Ingénieur* A3465 pp 1-18.
- [36] Flandin L, Vouyovitch L, Beroual A, Bessede JL and Alberola ND 2005 Influences of degree of curing and presence of inorganic fillers on the ultimate electrical properties of epoxy-based composites: experiment and simulation *J. of Phys. D: Appl. Phys.* **38** 144-155

- [37] Gallot-Lavallée O, Teyssedre G, Laurent C and Rowe S 2005 Space charge behaviour of an epoxy resin: the influence of fillers, temperature and electrode material, *J. of Phys. D: Appl. Phys.* **38**, 2017-2025
- [38] Tuncer E, Sauers I, James DR and Ellis AR 2009 Electrical insulation characteristics of glass fiber reinforced resins *IEEE Trans. Appl. Superconduct.* **19** (3) 2359-2362
- [39] Cygan S and Laghari JR 1987 Dependence of the electric strength on thickness area and volume of polypropylene *IEEE Trans. Dielect. and Elect. Insul.* **22** (6) 835–837
- [40] Zhou H, Shi FG and Zhao B 2003 Thickness dependent dielectric breakdown of PECVD low-k carbon doped silicon dioxide dielectric thin films: modeling and experiments *Microelectronics J.* **34** (4) 259-264
- [41] Kyritsis A, Vikelis G, Maroulas P, Pissis P, Milosheva B, Kotsilkova R, Toplijska A, Silvestre C and Duraccio D 2011 Polymer dynamics in epoxy/alumina nanocomposites studied by various techniques *J. of Appl. Polym. Sci.* **121** (6) 3613-3627
- [42] Kim HK and Shi FG 2001 Thickness dependent dielectric strength of a low-permittivity dielectric film *IEEE Trans. Dielect. and Elect. Insul.* **8** (2) 248-252
- [43] Helgee B and Bjellheim P 1991 Electric breakdown strength of aromatic polymers: dependence on film thickness and chemical structure *IEEE Trans. Dielect. and Elect. Insul.* **26** (6) 1147–1152
- [44] Champion JV and Dodd SJ 1995 The effect of voltage and material age on the electrical tree growth and breakdown characteristics of epoxy resins *J. of Phys. D: Appl. Phys.* **28**, 398-407
- [45] Shibuya Y, Zoledzowski S and Calderwood JH 1977 Void formation and electrical breakdown in epoxy resin, *IEEE Trans. on Power Apparatus and Syst.* **96** (1) 198-207