



**HAL**  
open science

## On the Contributions of Pavel Andreevich Zhilin to Mechanics

Holm Altenbach, Victor A. Eremeyev, Dmitry A. Indeitsev, Elena A. Ivanova,  
Anton M. Krivtsov

► **To cite this version:**

Holm Altenbach, Victor A. Eremeyev, Dmitry A. Indeitsev, Elena A. Ivanova, Anton M. Krivtsov.  
On the Contributions of Pavel Andreevich Zhilin to Mechanics. Technische Mechanik, 2009, 29 (2),  
pp.115-134. hal-00824120

**HAL Id: hal-00824120**

**<https://hal.science/hal-00824120>**

Submitted on 21 May 2013

**HAL** is a multi-disciplinary open access archive for the deposit and dissemination of scientific research documents, whether they are published or not. The documents may come from teaching and research institutions in France or abroad, or from public or private research centers.

L'archive ouverte pluridisciplinaire **HAL**, est destinée au dépôt et à la diffusion de documents scientifiques de niveau recherche, publiés ou non, émanant des établissements d'enseignement et de recherche français ou étrangers, des laboratoires publics ou privés.

# On the Contributions of Pavel Andreevich Zhilin to Mechanics

H. Altenbach, V. A. Eremeyev, D. A. Indeitsev, E. A. Ivanova, A. M. Krivtsov

*This paper is dedicated to the memory of Pavel A. Zhilin (1942–2005), the great Russian scientist in the field of Rational Mechanics. He was educated and worked at the State Polytechnical University in St. Petersburg (Russian Federation), formerly known as the Polytechnical Institute. As Head of the Department of Theoretical Mechanics he supervised sixteen PhD theses (Candidate of Science theses) and six higher doctorates (Habitations or Doctor of Science theses), some of them are shown on Fig. 2. His scientific interests covered various branches of Mechanics and Theoretical Physics. In his research he strived to pave a way based on Rational Mechanics to areas which are traditionally not associated with Mechanics, such as Physics of Microstructures and Electrodynamics. The paper gives a brief summary of the scientific biography and the main results obtained by Pavel A. Zhilin<sup>1</sup>.*

## 1 Theory of Shells

Pavel A. Zhilin's early publications, his Candidate of Science and Doctor of Science theses are devoted to the development of consistent theory of shells. When he started his research in this area, no general theory of shells was available. For each class of shell-type structures there were particular (and mostly independent) theories: the theory of thin single-layer shells, the theory of structural anisotropic shells, the theory of ribbed shells, the theory of thin multilayered shells, the theory of perforated shells, the theory of cellular shells, the theory of thick single-layer shells among others, see, e.g., Naghdi (1972); Grigolyuk and Kogan (1972); Grigolyuk and Seleznev (1973). Within each theory there are differences in basic assumptions as well as in resulting equations. The main motivations behind these theories were new applications that could not be described within the existing theories. Between 1975 and 1984 Zhilin formulated the general non-linear theory of thermoelastic simple shells. Some parts of this theory differ fundamentally from the other approaches in the shell theory discussed, for example, in Reissner (1985).

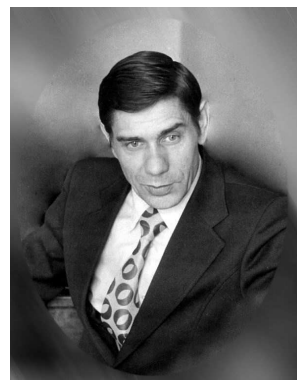

Figure 1: Pavel Andreevich Zhilin (1942-2005)



Figure 2: Pavel Zhilin together with his wife Nina, his scholars Anton Krivtsov, Alexandr Sergeyev, his colleague Vladimir Pal'mov (from left to right second line) and his scholars Elena Ivanova, Ekaterina Pavlovskaja, Sergei Gavrilov and Elena Grekova (from left to right first line) (Zelenogorsk, 1996)

<sup>1</sup>Some additional information can be found in Altenbach et al. (2007).

The basic definition of Zhilin's theory is:

*A simple shell is a two-dimensional continuum in which the interaction between neighboring parts is due to forces and moments.*

In addition, two assumptions are formulated:

*The representation of the shell (for example, homogeneous or inhomogeneous in thickness direction) is given by a deformable surface.*

This assumption results in the concept of effective properties allowing to present various classes of shells by similar equations, only the effective properties (e.g. stiffness) characterize each shell under consideration.

*Each material point of the surface is an infinitesimal body with 6 independent degrees of freedom (3 translations and 3 rotations).*

This assumption allows for the formulation of the shell theory with independent rotations instead of rotations which are derivatives of the displacements. The theory established by Zhilin can be easily generalized for any shell-like structure and can be applied to other problems in continuum mechanics. The basics and some discussions are given in Zhilin (2006a). Several applications are presented in this journal in the early 80th, see Altenbach and Shilin (1982).

Let us discuss briefly the basic features of Zhilin's theory of simple shells. The reference configuration (undeformed state) is defined by  $\{r(q^1, q^2); \mathbf{d}_k(q^1, q^2)\}$ , where  $r(q^1, q^2)$  is the position vector,  $\mathbf{d}_k(q^1, q^2)$  are orthonormal vectors, so-called directors. The actual configuration (deformed state) is given by  $\{R(q^1, q^2, t); \mathbf{D}_k(q^1, q^2, t)\}$ ,  $\mathbf{D}_k \cdot \mathbf{D}_m = \delta_{km}$ . Thus, the motion of the directed surface is defined by  $R(q, t)$  and  $P(q, t) \equiv \mathbf{D}^k(q, t) \otimes d_k(q)$ , where  $P(q, t) \equiv P(q^1, q^2, t)$  is the rotation tensor,  $\text{Det } P = +1$ . Finally, one obtains the linear and the angular velocities  $v(q, t), \omega(q, t)$

$$\mathbf{v} = \dot{R}, \quad \dot{P} = \omega \times P, \quad P(q^1, q^2, 0) = P_0, \quad \dot{f} \equiv \frac{df}{dt}$$

The balances of linear momentum and moment of momentum yield the first and the second Euler equation of motion

$$\nabla \cdot \mathbf{T} + \rho \mathbf{f} = \rho(\mathbf{v} + \Theta_1^T \cdot \omega), \quad \nabla \cdot \mathbf{M} + \mathbf{T}_\times + \rho \mathbf{l} = \rho(\Theta_1 \cdot \mathbf{v} + \Theta_2 \cdot \omega) + \rho \mathbf{v} \times \Theta_1^T \cdot \omega \quad (1)$$

with  $\mathbf{T} = R_\alpha \otimes T^\alpha$  the force tensor of Cauchy type,  $\mathbf{M} = R_\alpha \otimes M^\alpha$  the moment tensor of Cauchy type,  $\mathbf{f}, \mathbf{l}$  the mass density of the external forces and moments,  $\rho, \rho \Theta_1, \rho \Theta_2$  the density, the first and the second tensor of inertia,  $\nabla \equiv \mathbf{R}^\alpha(q^1, q^2, t) \frac{\partial}{\partial q^\alpha}$  the Nabla operator, and  $\mathbf{T}_\times \equiv R_\alpha \times T^\alpha$  for any second rank tensor  $T$ .

In the case of elastic shells, the constitutive equations can be derived from the surface density of the stored energy

$$W = W(\mathbf{U}, \mathbf{K}), \quad (2)$$

where  $\mathbf{U}$  and  $\mathbf{K}$  are Lagrangian strain measures

$$\mathbf{U} = \mathbf{F} \cdot \mathbf{P}, \quad \mathbf{K} = -\frac{1}{2} \mathbf{r}^\alpha \otimes \left[ \mathbf{P}^T \cdot \frac{\partial \mathbf{P}}{\partial q^\alpha} \right]_\times, \quad (3)$$

and  $\mathbf{F} = \nabla R$ .

The tensor of forces and the tensor of moments can be calculated by the derivatives of  $W$

$$\mathbf{T} = J^{-1} F^T \cdot \frac{\partial W}{\partial \mathbf{U}} \cdot \mathbf{P}^T, \quad \mathbf{T} = J^{-1} F^T \cdot \frac{\partial W}{\partial \mathbf{K}} \cdot \mathbf{P}^T, \quad (4)$$

where

$$J = \sqrt{\frac{1}{2} [\text{tr}^2 (\mathbf{F} \cdot \mathbf{F}^T) - \text{tr} (\mathbf{F} \cdot \mathbf{F}^T)^2]}$$

Similar variants within the direct approach have been established, for example, in Eremeyev (2005); Eremeyev and Zubov (2007, 2008); Shkutin (1985); Zubov (1997, 2001).

Let us note that Eqs (1) are formulated directly for the two-dimensional continuum, but they are in a good agreement with the equations of the general nonlinear theory of shells, which can be deduced from the three-dimensional theory and which are presented, for example, in Libai and Simmonds (1983, 1998); Chróścielewski et al. (2004); Eremeyev and Pietraszkiewicz (2004, 2006). The deformation measures and the constitutive equations in these theories are practically the same to (3), (2), (4).

The direct approach in the theory of shells has been suggested first by Ericksen and Truesdell (1958). The shell is modeled as a deformable surface with a number of directors  $\mathbf{D}_k(q^1, q^2)$ ,  $k = 1 \dots p$ . In this variant it was not assumed that the directors are orthogonal and normalized. The theory was called Cosserat shell or Cosserat surface theory. After this pioneering work various theories with one deformable director have been developed, see, for example, Green et al. (1965); Green and Naghdi (1968, 1974); Naghdi (1972) and the monographs by Rubin (2000) and Antman (2005). In addition to the traditional approaches, the thickness changes are taken into account. However, the main problem of all these approaches is that the interaction between different parts of the shell are not presented by forces and moments only. This means that all these theories contains higher order stress resultants.

In Zhilin (1982b); Altenbach and Zhilin (1988) the general theory with six degrees of freedom is transformed to a theory of shells with five degrees of freedom (similar to the Reissner's theory) introducing some constraints for the deformations. The main constraint is, that one of the directors, for example  $\mathbf{D}_3$  is the normal to the surface:  $\mathbf{D}_3 = \mathbf{N}$ . It must be underlined that the director  $d_3$  can be assumed to be identical to the normal in the reference configuration  $n$ . In this case rotations about  $\mathbf{D}_3$  have no influence on the strain energy of the shell. It is physically clear that such type of deformation is very small in comparison to the bending or tension deformations, especially in the case of smooth surfaces. This invariance property results in a less number of independent components of the strain measures (3). In this case the strain energy and the set of strain tensors can be given as it follows

$$W = W(\mathcal{E}, \mathcal{K}, \boldsymbol{\gamma}), \quad \mathcal{E} = \frac{1}{2} (\mathbf{U} \cdot \mathbf{U}^T - \mathbf{a}), \quad \mathcal{K} = \mathbf{K} \cdot \mathbf{U}^T - \frac{1}{2} \mathbf{k} \cdot \mathbf{U} \cdot \mathbf{U}^T - \frac{1}{2} \mathbf{k} \cdot \mathbf{a}, \quad \boldsymbol{\gamma} = \mathbf{U} \cdot \mathbf{n},$$

where  $\mathbf{a} = \mathbf{E} - \mathbf{n} \otimes \mathbf{n}$  is the two-dimensional unit tensor,

$$\mathbf{k} = \frac{1}{2} \mathbf{r}^\alpha \otimes \left( \mathbf{d}_k \times \frac{\partial \mathbf{d}_k}{\partial q^\alpha} \right).$$

The simplest example of the strain energy is the following quadratic form

$$W = \frac{1}{2} \mathcal{E} \cdot \cdot \mathbf{A} \cdot \cdot \mathcal{E} + \mathcal{E} \cdot \cdot \mathbf{B} \cdot \cdot \mathcal{K} + \frac{1}{2} \mathcal{K} \cdot \cdot \mathbf{C} \cdot \cdot \mathcal{K} + \mathcal{E} \cdot \cdot \boldsymbol{\Gamma}_1 \cdot \boldsymbol{\gamma} + \mathcal{K} \cdot \cdot \boldsymbol{\Gamma}_2 \cdot \boldsymbol{\gamma} + \frac{1}{2} \boldsymbol{\gamma} \cdot \cdot \boldsymbol{\Gamma} \cdot \boldsymbol{\gamma}.$$

Here  $\mathbf{A}$ ,  $\mathbf{B}$ ,  $\mathbf{C}$  are fourth rank tensors,  $\boldsymbol{\Gamma}_1$ ,  $\boldsymbol{\Gamma}_2$  are third rank tensors, while  $\boldsymbol{\Gamma}$  is a second rank tensors,  $\cdot \cdot$  is the double contraction product. The tensors  $\mathbf{A}$ ,  $\mathbf{B}$ ,  $\mathbf{C}$ ,  $\boldsymbol{\Gamma}_1$ ,  $\boldsymbol{\Gamma}_2$  and  $\boldsymbol{\Gamma}$  reflect the individual properties of the shell. They are named effective stiffness properties of the shell. Note that general expressions of the strain energy are discussed in Zhilin (2006a).

This variant of the theory is discussed in Altenbach and Zhilin (2004); Altenbach (1987); Altenbach et al. (2005); Zhilin (2006a); Altenbach (2000a,b); Altenbach and Eremeyev (2008a,b). In Grekova and Zhilin (2000, 2001) the method presented in Zhilin (1982b); Altenbach and Zhilin (1988) is applied to the three-dimensional case. In particular, the identification procedure of the effective stiffness tensors for various anisotropic shells is developed in Zhilin (2006a); Altenbach (2000a,b).

## 1.1 Discretely Stiffened Thermoelastic Shells

The general theory of discretely stiffened thermoelastic shells has been developed between 1965 and 1970 (Zhilin, 1968, 1970) and applied to the following practical problems including the analysis of the high-pressure water

turbine spiral of the Nurek hydropower station (Zhilin and Mikheev, 1968) and of the vacuum chamber of the thermonuclear Tokamak-20 panel (Zhilin et al., 1982). In 1966 Zhilin has proposed a modification of the Steklov<sup>2</sup>-Fubini<sup>3</sup> method for differential equations, the coefficients of which have singularities of  $\delta$ -function type. This method allows for finding the solution in an explicit form for a problem of axisymmetric deformations of a discretely stiffened cylindrical shell, see Zhilin (1966).

## 1.2 New Formulation of the Second Law of Thermodynamics Applied to Deformable Surfaces

A new formulation of the second law of thermodynamics has been proposed in 1973, see, for example, Zhilin (1975a,b, 1976), by means of the combination of two Clausius<sup>4</sup>-Duhem<sup>5</sup>-Truesdell<sup>6</sup> type inequalities, e.g. Truesdell (1984); Zhilin (2006a). This formulation is based on the assumption of a deformable oriented surface, each side of which (top and bottom sides) has its own temperature and entropy. This means that the formulation contains two entropies  $\eta_{\pm}$ , two internal temperature fields  $T_{\pm}$ , and two external temperature fields  $T_{\pm}^{\text{ext}}$ . Both inequalities can be written as

$$\begin{aligned} \frac{d}{dt} \iint_{\sigma} \rho \eta_{+} d\sigma &\geq \iint_{\sigma} \rho \left( \frac{q_{+}}{T_{+}^{\text{ext}}} + \frac{Q_{+}}{T_{-}} + \frac{q_{+}^{\sigma}}{T_{+}} \right) d\sigma - \int_{\omega} \frac{q_{+}^{\nu}}{T_{+}} ds, \\ \frac{d}{dt} \iint_{\sigma} \rho \eta_{-} d\sigma &\geq \iint_{\sigma} \rho \left( \frac{q_{-}}{T_{-}^{\text{ext}}} + \frac{Q_{-}}{T_{+}} + \frac{q_{-}^{\sigma}}{T_{-}} \right) d\sigma - \int_{\omega} \frac{q_{-}^{\nu}}{T_{-}} ds \end{aligned} \quad (5)$$

Here  $\sigma$  – denotes an arbitrary part of the shell,  $\omega = \partial\sigma$  is its boundary,  $q^{\nu}$  the heat flux through the boundary,  $q_{\pm}^{\sigma}$  the heat flux through the surface  $\pm$ ,  $Q_{+} = -Q_{-}$  denotes the volume heat exchange between both sides of the surface.

It should be noted that the formulation of the thermodynamics for two-dimensional systems like shells is connected with several difficulties. For example, in the case of a simple material any material point is linked to one temperature. For deformable surfaces this is not enough. The problems are related to the presentation of a three-dimensional temperature field by two-dimensional field equations. In contrast to Zhilin (1975a,b, 1976), other models with one temperature, see Murdoch (1976a,b) among others, or with one temperature field and an additional scalar field of the temperature gradient with respect to the thickness, Green and M. (1970, 1979); Simmonds (1984, 2005) are suggested. In Makowski and Pietraszkiewicz (2002) three temperature fields are suggested, two temperature fields in Eremeyev and Zubov (2008). The use of two temperature fields is the more natural way in comparison with the other approaches since the boundary conditions and the constitutive equations can be presented by very simple expressions. This approach is similar to the representation of a two-component continuum with the following properties: material points of both components can be located in the same position, but the temperatures must be different, see, e.g., Bowen (1967); Atkin and Crain (1976a,b).

Apart from the theory of shells, this elaboration of the second law of thermodynamics is also useful for the Solid State Physics when studying the influence of skin effects on the properties of solids, as well as for the description of interfaces between different phases of a solid, see Zhilin (2007). A similar approach has been applied to the modeling of fibre suspensions, see Altenbach et al. (2003b).

## 1.3 Generalisation of the Classical Theory of Symmetry of Tensors

In 1977 an important extension has been made to the tensor algebra, namely the concept of oriented tensors, i.e. tensor objects which depend on the orientation in both the three-dimensional space and in its subspaces. The theory of symmetry formulated in Zhilin (1978, 1982b) is presented for oriented tensors. It generalizes the classical theory of symmetry, which can be applied to Euclidean tensors only. In Fig. 3 the definition of an axial vector (spin vector) is visualized. Such a type of mathematical objects depends on the orientation of the reference system. On the other hand, the spin vectors are necessary, for example, for the description of rotations or moments in statics or rigid body dynamics. In addition, axial tensors play an important role in the theory of shells or rods, if the direct approach is applied.

<sup>2</sup>Vladimir Andreevich Steklov (1864-1926); Soviet/Russian mathematician, mechanic and physicist

<sup>3</sup>Guido Fubini (1879-1943); Italian mathematician

<sup>4</sup>Rudolf Julius Emanuel Clausius (1822-1888); German physicist

<sup>5</sup>Pierre Maurice Marie Duhem (1861-1916); French physicist and philosopher of science

<sup>6</sup>Clifford Ambrose Truesdell III (1919-2000); American mathematician

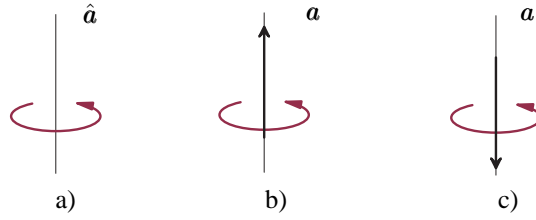

Figure 3: Oriented system of reference: a) Object  $\hat{a}$  is named spin vector, b) Straight arrow is the axial vector  $a$  corresponding to  $\hat{a}$  in the right oriented system of reference, b) Straight arrow is the axial vector  $a$  corresponding to  $\hat{a}$  in the left oriented system of reference,

Figures 4 and 5 show two types of vectors - the spin vector and the polar vector. The first one represents, for example, a moment, the second one a force. The mirror symmetry can be mathematically described by the orthogonal tensor  $Q = E - 2n \otimes n$ , where  $E$  is the unit tensor and  $n$  is the normal unit vector with respect to the mirror plane. As shown in Fig. 4, only for the polar vector  $Q$  belongs to the group of symmetry. The opposite situation it obtained, if the vector is in the same direction like the normal  $n$  (Fig. 5). It is shown that the application of the classical theory, i.e. objects dependent on the orientation in the three-dimensional space, sometimes leads to wrong conclusions, see Grekova and Zhilin (2001); Kolpakov and Zhilin (2002); Zhilin (2006e). The proposed theory is necessary to obtain the constitutive equations for shells and other multi-polar media, as well as when studying ionic crystals.

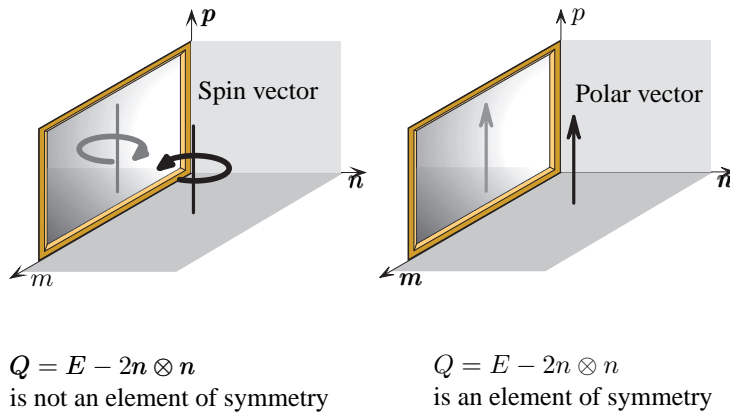

Figure 4: Spin and polar vectors (I)

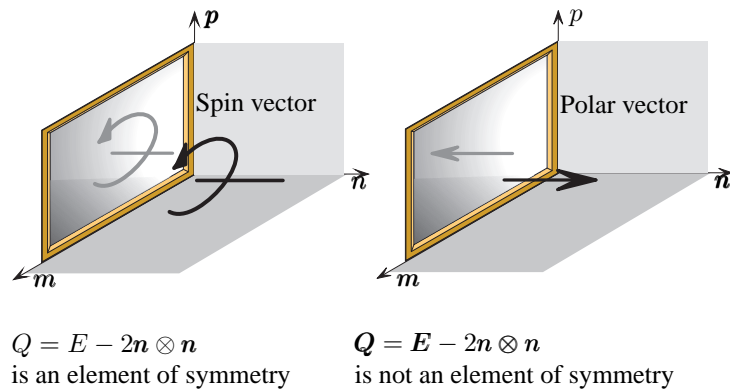

Figure 5: Spin and polar vectors (II)

The transformation rules for axial and polar tensors and vectors are different with respect to orthogonal transformations. This fact is very helpful in the formulation of local symmetry groups of the constitutive equations. This has been pointed out in Zhilin (1982b); Altenbach and Zhilin (1988) for shells. Another example is the so-called micropolar theory of shells. The wryness tensor in the three-dimensional micropolar continuum and the bending tensor (curvature change tensor) in the shell theory are axial tensors or so-called pseudo-tensors. They change the sign under the mirror reflection transformation of the space. This fact is not taken into account in Kafadar and

Eringen (1976) considering a three-dimensional micropolar continuum and in Murdoch and Cohen (1979, 1981) where a local symmetry group for Cosserat shell theory is deduced. In Eremeyev and Pietraszkiewicz (2006); Eremeyev and Zubov (2008) the stretch tensor is suggested to be a polar tensor while the bending tensor is an axial one.

The theory of the symmetry for tensor functions is developed. A new definition for tensor invariants was given in Zhilin (2003b, 2005); Altenbach et al. (2006). This definition coincides with the traditional one only for Euclidean tensors. It is shown that any invariant can be obtained as a solution of a differential equation of first order. The number of independent solutions of this equation determines the minimum number of invariants that are necessary to fix the system of tensors as a solid unit.

#### **1.4 General Nonlinear Theory of Thermoelastic Simple Shells**

The general non-linear theory of thermoelastic simple shells is formulated and established between 1975 and 1984. The way of its formulation differs fundamentally from all known shell theories. The theory can be easily extended to any shell-like structure and other objects of continuum mechanics (for example, rods). Its key feature is that it allows to study shell-like objects of a complex internal structure, when traditional methods are not applicable, see, for example, Zhilin (1972, 1975a,b, 1976, 1978); Altenbach and Shilin (1982); Zhilin (1982b); Altenbach and Zhilin (1988). For shells of constant thickness made of isotropic material, the new method gives results that are in accordance with those of the classical formulations and perfectly coincide with the results of the three-dimensional theory of elasticity for an arbitrary external loading including point loads, see Zhilin and Skvorcov (1983); Zhilin and Il'icheva (1980, 1984).

#### **1.5 Paradox in the Problem of Bending Deflection of a Circular Plate**

The exact analytical solution is given for the problem of finite displacements of a circular plate, see Zhilin (1982a, 1984). The solution explains a well-known paradox that is described in handbooks and assumed that the deflection of a membrane, i.e. a plate with zero bending stiffness, is less than the deflection calculated with non-zero bending stiffness. The problem considers a circular plate with fixed edge and loaded by transversal pressure. In this case, for some pressure values the linear theory is no more applicable since it overestimates the deflection approximately 25 times. The theory published in Zhilin (1982a, 1984) has been used in calculations of an electrodynamic gate, see Venatovsky et al. (1987).

#### **1.6 Final Remarks**

The surveys of the theory of simple shells published by Altenbach and Zhilin (1988); Zhilin (1992b, 1995c) demonstrate the capacity of the new theory in comparison with the traditional ones. The main advantages are:

- a clear definition of the simple shell,
- an introduction of six independent degrees of freedom in each material point of the surface,
- an application of the thinness-hypothesis as late as possible,
- a consequent application of the tensor analysis introducing axial and polar mathematical objects, which can be oriented,
- an application of the theory of symmetry and the dimension analysis to establish the constitutive equations,
- an introduction of the concept of effective properties.

The correctness of Zhilin's theory is verified by independent research results including Kienzler (2002); Tovstik and Tovstik (2007) and others. The extension to the viscoelastic case is discussed, for example, in Altenbach (1987).

## 2 Theory of Rods

The dynamic theory of thin spatially curvilinear and naturally twisted rods is developed between 1987 and 2005. By analogy to the theory of shells, the rod in Zhilin's theory is modeled by a deformable line consisting of material points with 6 independent degrees of freedom. The various classes of rods are described with the help of the effective properties concept. The proposed theory includes all known variants of the theories of rods, but it has a wider domain of application. A significant part of the publications in this field is devoted to the analysis of various classical problems, including those the solutions of which have paradoxes. The main results of the theory of rods and its applications are presented in the most complete way in Zhilin (2006b).

Like in the case of shells, Zhilin has presented the kinematics of the rod by three orthonormal directors  $D_i$ ,  $i = 1, 2, 3$ . This approach is firstly discussed in Ericksen and Truesdell (1958); Green et al. (1973); Naghdi and Rubin (1984); Cohen and Sun (1992), see Rubin (2000) where the concept of the set of deformable directors is applied. In contrast to other publications like Ericksen and Truesdell (1958); Green et al. (1973); Naghdi and Rubin (1984); Cohen and Sun (1992); Rubin (2000), Zhilin's approach is based again only on forces and moments.

### 2.1 General Nonlinear Theory of Rods and its Applications to the Solution of Particular Problems

Based on the methods developed for the theory of shells, the general non-linear theory of flexible rods is formulated by Goloskokov and Zhilin (1987), where all the basic cases of deformation (bending, torsion, tension, transversal shear) are taken into account. The introduction of the rotation (turn) tensor allows to write down the equations in a compact form, convenient for the mathematical analysis. In contradiction to previous theories, the proposed one describes the experimentally discovered Poynting<sup>7</sup> effect (the contraction of a rod under torsion, Backhaus (1983); Billington (1986)), which is also discussed by Zhilin's supervisor Prof. Lurie<sup>8</sup> (Fig. 6). The developed theory is



Figure 6: Pavel Zhilin together with his supervisor Anatolii Lurie and his colleague Vladimir Pal'mov (from left to right, House of Scientists of the Leningrad Polytechnical Institute, 1971)

applied to the analysis of particular problems, see Zhilin and Tovstik (1995); Zhilin et al. (1997). A new method is suggested in Zhilin (2006b, 2007, 2006c) for the formulation of the elastic stiffness tensors. In these publications a new theory of symmetry of tensors, determined in the space with two independent orientations, is essentially used. All stiffness constants are identified for plane curvilinear rods.

### 2.2 Euler's Elastica

The famous Euler's<sup>9</sup> elastica problem is considered in Zhilin et al. (1997); Zhilin (1997b, 2006b, 2007, 2006c), where it was shown that apart from the known static equilibrium configurations there exist also dynamic equilibrium configurations. In the latter case, the form of the elastic curve remains the same, and the bent rod rotates about the axis orthogonal to the rod axis. The energy of deformation does not change in this motion. Note that this is not the rigid motion of a rod, since the clamped end of the rod remains fixed. This means that the curvilinear

<sup>7</sup>John Henry Poynting (1852-1914); British physicist

<sup>8</sup>Anatolii Isaakovich Lurie (1901-1980); Soviet mechanician

<sup>9</sup>Leonhard Euler (1707-1783); Swiss mathematician who worked in Berlin and St. Petersburg





Figure 7: Pavel Zhilin together with Dmitry Indeicev, Holm Altenbach and Alexandr Sergeyev (from left to right, XXVIIth Summer School, Repino, 2000)

equilibrium configuration in the Euler's elastica is unstable, contrary to the common point of view. This conclusion however has not been confirmed by experiments yet.

### 2.3 Nikolai's Paradox

Nikolai's<sup>10</sup> paradox is analyzed in Zhilin and Sergeyev (1993a,b, 1994); Zhilin et al. (1997); Zhilin (2006b,c, 2007). The paradox appears when a rod is torsioned by means of a torque applied to its end. The experiment shows that the torsion torque stabilizes the rod, which contradicts the theory. It was shown in Zhilin (2006c), that one may avoid the mentioned paradox if a special constitutive equation for the torque is chosen. The torque has to depend in a special way on the rotational velocity. This dependence is not related to the existence (or absence) of the internal friction in the rod.

### 2.4 Development of Mathematical Methods

An approach, which allows to analyze the stability of motion in the presence of spinor motions described by means of rotation (turn) tensor is suggested in Zhilin (1995d). The problem is that the rotation tensors are not elements of a linear space (unlike the displacement vectors). Thus the equations in variations have to be written down as a system of equations, the right parts of which depend nonlinearly on the previous variations. However, the obtained system of equations allows for the exact separation of variables, i.e. the separation from the time variable.

## 3 Dynamics of Rigid Bodies

The advantage of Zhilin's representation of the dynamics of rigid bodies is that it is consequently formulated in terms of the direct tensor calculus. A new mathematical technique is developed for the description of spinor motions. This technique is based on the use of the rotation (turn) tensor and related concepts. The new results in the dynamics of rigid bodies are mostly presented in Zhilin (2001b,c, 2003c).

### 3.1 Development of Mathematical Methods

The general investigation of the rotation (turn) tensor is given in Zhilin (1992a, 2001a, 2003c), where a new proof of Euler's kinematic equation was obtained. The old (and correct) proof of the kinematic equation can be found in the original publications of Euler and in some old Theoretical Mechanics textbooks, but it is very tedious. In the well-known book of Levi-Civita<sup>11</sup> and Amaldi<sup>12</sup> (see Levi-Civita and Amaldi (1926, 1927)) a new compact proof is suggested, but it is incorrect. Later this proof is widely distributed and repeated in almost all modern courses on Theoretical Mechanics with exception of the book by Suslov (1946). In Zhilin (1992a), the proof of a new theorem on the composition of angular velocities, different from those cited in classical textbooks, is proposed. The new equation, see Zhilin (1992a, 1997c, 2000, 2001c, 2003c), relates the left angular velocity to the derivative of the rotation vector. This equation is necessary to introduce the concept of potential torque. Apart from that it is very

<sup>10</sup>Evgenij Leopoldovich Nikolai (1880-1950); Russian/Soviet mechanician

<sup>11</sup>Tullio Levi-Civita (1873-1941); Italian mathematician

<sup>12</sup>Ugo Amaldi (1875-1957); Italian mathematician

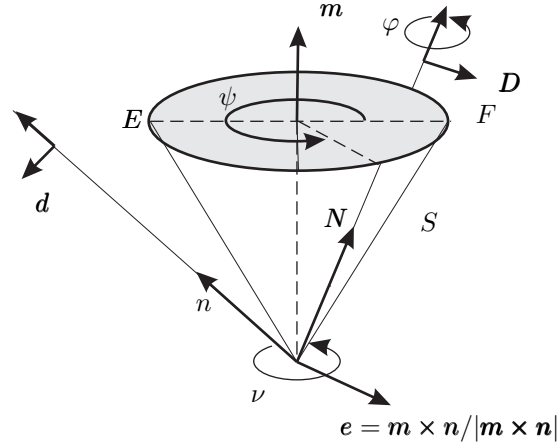

Figure 8: Introduction of Eulerian angles with the help of the turn tensor

useful when solving numerically problems of dynamics of rigid bodies since there is no need to introduce either systems of angles, or systems of parameters of the Klein<sup>13</sup>-Hamilton<sup>14</sup> type.

A new theorem on the representation of the rotation (turn) tensor composing turns about arbitrary fixed axes is suggested in Zhilin (1995a, 1996b, 1998, 2001c, 2003c). All previously known representations of the rotation (turn) tensors, or, more precisely, of their matrix analogues, via Eulerian angles (Fig. 8), Tait<sup>15</sup>-Bryan<sup>16</sup> angles, plane or ship angles, etc. (see, for example, Lurie (2002); Brommundt (2006)), are particular cases of this general theorem, the role of which, however, is not only a simple generalization of these cases. Figure 8 is related to the following theorem suggested by Zhilin:

*Any arbitrary rotation  $Q(\theta)$  can be introduced as a composition of rotations about the arbitrary selected and fixed at time axes  $\mathbf{m}$  and  $\mathbf{n}$*

$$Q(\theta) = Q(\psi(t)\mathbf{m}) \cdot Q(\vartheta(t)\mathbf{e}) \cdot Q(\varphi(t)\mathbf{n}), \quad \mathbf{e} = \frac{\mathbf{m} \times \mathbf{n}}{|\mathbf{m} \times \mathbf{n}|},$$

*where the angles  $\psi(t), \vartheta(t), \varphi(t)$  are the angles of precession, nutation and eigen-rotation. If  $\mathbf{m} = \mathbf{n}$ , the angles  $\psi(t), \vartheta(t), \varphi(t)$  are the Eulerian angles, and the vector  $\mathbf{e}$  is selected arbitrary, but orthogonal to  $\mathbf{n}$ .*

The most important fact is that one can introduce any traditional system of angles. However, one describes the (unknown) rotation of a body in terms of turns about these axes. If this choice is made in an inefficient way or if it is difficult to make an appropriate choice, the chances to integrate or even to analyze qualitatively the resulting system of equations are very poor. Moreover, even in those cases when it is possible to integrate the system, the obtained solution is often not of practical use, since it contains poles or indeterminacy of the type zero divided by zero. Consequently, the numerical solution, even after the first pole or indeterminacy becomes very distorted. The advantage and the purpose of the theorem under discussion is the fact that it allows to consider the axes of rotation as principal variables and to determine them in the process of obtaining solution. As a result, one can obtain the simplest (among all possible forms) solutions.

In Zhilin (1997c, 1998, 2000) an approach is proposed, which allows to analyze the stability of motion in the presence of spinor rotations described by the rotation (turn) tensor. The method of perturbations for the group of proper orthogonal tensors was developed.

<sup>13</sup>Felix Christian Klein (1849-1925); German mathematician

<sup>14</sup>Sir William Rowan Hamilton (1805-1865); Irish mathematician

<sup>15</sup>Peter Guthrie Tait (1831-1901); Scottish physicist and mathematician

<sup>16</sup>George Hartley Bryan (1864-1928); British mathematician and expert in aeronautics

### 3.2 New Solutions of Classical Problems

A new solution is obtained in Zhilin (1995a, 1996b) for the classical problem of the free rotation of a rigid body about a fixed center of mass (Euler's case). It is shown that for each tensor of inertia, the entire domain of initial values is divided into two sub-domains. It is known that there is no such a system of parameters, which would allow to cover the entire domain of initial values by a unique map without poles. This fact is confirmed in Zhilin (1996b), where in each sub-domain and at the boundary between them the body rotates about different axes, depending only on the initial values. Stable rotations of the body correspond to the interior points of the sub-domains mentioned above, and unstable rotations to the boundary points. When constructing the solution, the theorem on the representation of the rotation (turn) tensor as described above plays an essential role. Finally, all characteristics to be found can be expressed via one function, determined by a rapidly converging series of a simple form. For this reason, no problem appears in the simulations. The propriety of the determination of the axes, about which the body rotates, manifests in the fact that the velocities of the precession and the proper rotation have a constant sign. Note that in all previously known solutions only the sign of the precession velocity is constant, i.e. in these solutions only one axis of turns is correctly chosen. It follows from the solution, see Zhilin (1996b), that stable solutions, however, may be unstable in practice, if a certain parameter is small enough. In this case the body may jump from one stable rotational regime to another one under the action of arbitrarily small and short loads (like, e.g., a percussion with a small meteorite).

A new solution for the classical problem of the rotation of a rigid body with a transversely-isotropic tensor of inertia is obtained by Zhilin (1996d, 2006d) for a homogeneous gravity field (Lagrange's<sup>17</sup> case). The solution of this problem from the formal mathematical point of view has been known for a long time, and one can find it in many monographs and textbooks. However, it is difficult to make a clear physical interpretation of this solution, and some simple types of motion are described by it in an unjustifiably sophisticated way. In the case of a rapidly rotating gyroscope an approximate solution in elementary functions is obtained. It is shown by Zhilin (2006d) that the expression for the precession velocity, found by using the elementary theory of gyroscopes, gives an error in the principal term.

In the frame of the dynamics of rigid bodies, the explanation of the fact that the velocity of the rotation of the earth is not constant and the axis of the earth undergoes weak oscillations is given in Zhilin (2003c). Usually this fact is explained by the argument that one cannot consider the earth as an absolutely rigid body. However, if the direction of the dynamic spin differs slightly from the direction of the earth's axis, the earth's axis will make a precession about the vector of the dynamic spin, and, consequently, the angle between the axis of the earth and the plane of ecliptic will slightly change. In this case the alternation of day and night on the earth will not be determined by the proper rotation of the earth about its axis, but by the precession of the axis.

### 3.3 New Models in the Frame of the Dynamics of Rigid Bodies

In the Newtonian<sup>18</sup> dynamics an oscillator is a basic element. In the Eulerian mechanics, the analogous role plays a rigid body on an elastic foundation, and this system can be named a *rigid body oscillator* (Fig. 9). The latter one is

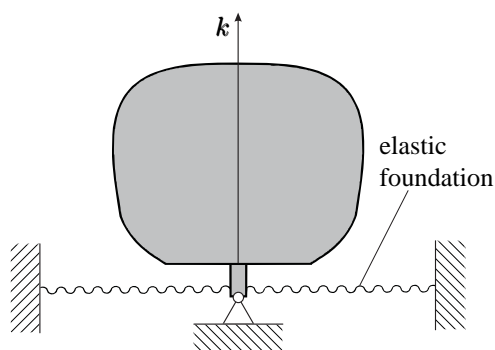

Figure 9: Rigid body on elastic foundation ( $k$  is the axis of rotation)

necessary when constructing the dynamics of multi-polar media, but in its general case it is neither investigated not

<sup>17</sup>Joseph-Louis Lagrange (1736-1813); Italian-French mathematician and astronomer (born as Giuseppe Lodovici/Luigi Lagrangia)

<sup>18</sup>Sir Isaac Newton (1643-1727); English physicist, mathematician, astronomer, natural philosopher, and alchemist

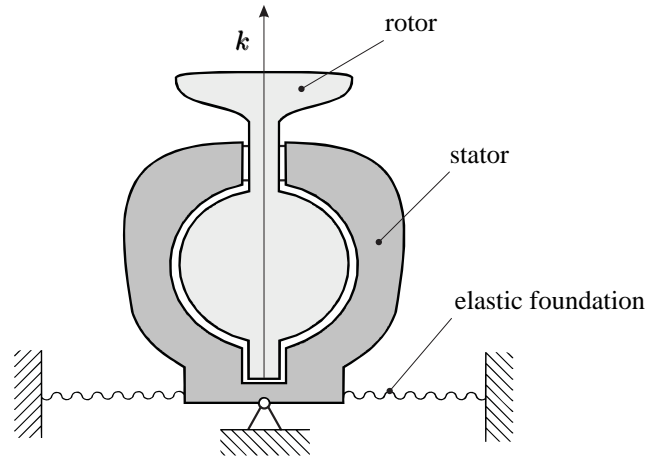

Figure 10: Gyrostat on elastic foundation ( $k$  is the axis of rotation)

even described in the literature. Of course, its particular cases are considered, for instance, in the analysis of the nuclear magnetic resonance, and also in many applied investigations, but only for infinitesimal angles of rotation. A new statement of the problem of the dynamics of a rigid body for a non-linear elastic foundation is proposed by Zhilin (1997c, 1998, 2000). The general definition of the potential of torque is introduced and some examples of problem solutions are given.

For the first time, the mathematical statement for the problem of a two-rotor gyrostat on an elastic foundation is given in Zhilin (1997c); Zhilin and Sorokin (1998); Zhilin (1999). The elastic foundation is described by introducing the strain energy as a scalar function of the rotation vector. Finally, the problem is reduced to the integration of a system of non-linear differential equations having a simple structure but a complex nonlinearity. The difference of these equations from those traditionally used in the dynamics of rigid bodies is that for their formulation it is not necessary to introduce any artificial parameters like the Eulerian angles or the Cayley<sup>19</sup>-Hamilton parameters. A new method of integration of the basic equations is described in Zhilin's papers. The solutions are obtained in quadratures for the isotropic non-linear elastic foundation.

The model of a rigid body is generalized in Zhilin (2003c) for the case of a body not consisting of mass points, but of point-bodies of general kind. There is considered a model of a quasi-rigid body, consisting of the rotating particles with distances between them remaining constant during the motion.

### 3.4 Dynamics of a Rigid Body on an Inertial Elastic Foundation

The problem of the construction of high-speed centrifuges with a rotational speed 120 000–200 000 rotations per minute required the development of more accurate mechanical models. An example of such model is shown on Fig. 10, where the motion is presented as a rigid body on elastic foundation. The parameters of the rotor and of the elastic foundation do not allow to consider the elastic foundation as inertialess. There a method is proposed in Zhilin and Tovstik (1995); Ivanova and Zhilin (2002), allowing to reduce the problem to the solution of a relatively simple integro-differential equation.

### 3.5 Coulomb Law of Friction and Paradoxes of Painlevé

The application of the Coulomb<sup>20</sup> law has its own specifics related to the non-uniqueness of the solution for the dynamic problems. It is shown that the Painlevé<sup>21</sup> paradoxes (see, e.g. Le (2003)) appear because of a priori assumptions about the character of motion and the character of the forces needed to induce this motion. The correct statement of the problem requires either to determine the forces by the given motion or to determine the motion by the given forces, see, e.g., Zhilin and Zhilina (1993); Wiercigroch and Zhilin (2000). The improved analysis is based on the enlarged model shown in Fig. 11.

<sup>19</sup>Arthur Cayley (1821-1895); British mathematician

<sup>20</sup>Charles Augustin de Coulomb (1736-1806); French physicist

<sup>21</sup>Paul Painlevé (1863-1933); French mathematician and politician, served twice as prime minister of the Third Republic

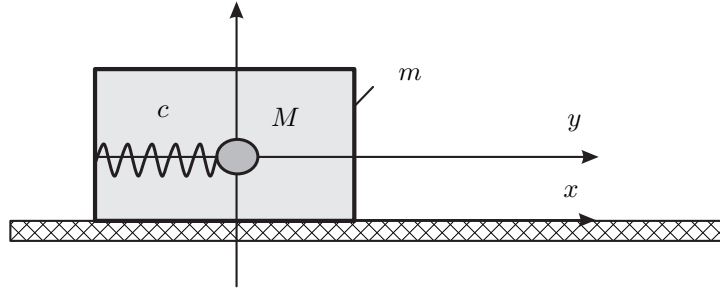

Figure 11: Enlarged model with two degrees of freedom ( $c$  - spring stiffness,  $M$  - mass of the body,  $m$  - mass of the framework,  $y, x$  - coordinates)

#### 4 Fundamental Laws of Mechanics

The formulations of the basic principles and laws of Eulerian mechanics are suggested in Zhilin (1994a, 1995b, 2001b, 2002a, 2003c) with an explicit introduction of spinor motions. All the laws are formulated for the "open bodies", i.e. bodies of a variable content, which appears to be extremely important when describing the interaction of macrobodies with electromagnetic fields. Apart from that, in these formulations the concept of a body itself is changed. The body may contain not only particles, but also various fields. Namely, the latter ones makes it necessary to consider bodies of variable content. The importance of spinor motions, in particular, is determined by the fact that the true magnetism can be defined only via the spinor motions, contrary to the induced magnetism, caused by Foucault<sup>22</sup> (eddy) currents, i.e. by translational motions.

A new basic object, the point-body, is introduced into consideration in Zhilin (1994a, 1995b, 2001b, 2002a, 2003c), where it is assumed that the point-body occupies zero volume, and its motion is described completely by means of its position-vector and its rotation (turn) tensor. It is postulated that the kinetic energy of a point-body has a quadratic form of its translational and angular velocities, and its momentum and proper kinetic moment (dynamic spin) are defined as partial derivatives of the kinetic energy with respect to the vector of translational velocity and the vector of angular velocity, respectively. The model of a point-body, see Zhilin (2003c), is described by three parameters: mass, moment of inertia, and an additional parameter  $q$ , conventionally named *charge*, which has never appeared in particles used in the classical mechanics. It is shown that the motion of this particle in an empty space has a spiral trajectory, and for some initial conditions a circular trajectory. It is thus shown that in inertial reference frames, the motion of an isolated particle (point-body) does not necessarily follow a linear path.

The concept of actions is developed by Zhilin (1994a, 1995b, 2001b, 2002a, 2003c) based on an axiom which supplements Galileo's<sup>23</sup> *Principle of Inertia*, generalizing it to the bodies of general kind. This axiom states that in an inertial reference system an isolated closed body moves in such a way that its momentum and momentum of momentum remain invariant. Further, both the forces and the torques are introduced into consideration, and the force acting upon a body is defined as the reason for the change of the momentum of this body, and the torque, acting upon a body as a reason of the change of the angular momentum. The set of vectors - the force vector and the moment vector - are called *action*.

The concept of the internal energy of a body, consisting of point-bodies of general kind, see Zhilin (1994a, 1995b, 2001b, 2002a, 2003c), is developed; the axioms for the internal energy to be satisfied are formulated. The principally new idea is to distinguish the additivity of mass from the additivity of bodies. The kinetic energy of a body is additive by its mass. At the same time, the internal energy of a body is additive to sub-bodies of which the body under consideration consists of, but, generally speaking, it is not an additive function of mass. In Cayley's problem, the paradox, related to the loss of energy, is resolved in Zhilin (2003c).

Basic concepts of thermodynamics (internal energy, temperature, and entropy) are introduced in Zhilin (2002a, 2003c) on elementary examples of mechanics of discrete systems. The definition of both the temperature concepts and the entropy are given by means of purely mechanical arguments, based on the use of a special mathematical formulation of the energy balance.

<sup>22</sup>Jean Bernard Léon Foucault (1819-1868); French physicist

<sup>23</sup>Galileo Galilei (1564-1642); Italian physicist, astronomer, astrologer, and philosopher

## 5 Other Problems

Zhilin was involved in discussions not only in the theories of rods, plates and shells and rigid body dynamics. He also considered the general problems of continuum mechanics and electrodynamics.

### 5.1 Electrodynamics

Zhilin investigated the invariance properties of the Maxwell<sup>24</sup> equations in Zhilin (1993, 1994b), while some modifications of these equations were proposed in Zhilin (1996c,a, 1997a). In his investigations he used some mechanical analogies between solutions of the equations of the rigid body dynamics and the Maxwell equations. It is shown in Zhilin (2006e), that the mathematical description of an elastic continuum of two-spin particles of a special type is reduced to the classical Maxwell equations. The mechanical analogy proposed above allows to state unambiguously that the vector of the electric field is axial, and the vector of the magnetic field is polar.

At the end of the XIXth century Kelvin<sup>25</sup> described a structure of an ether responsible, in his opinion, for the true (non-induced) magnetism, consisting of rotating particles. A specific kind of Kelvin medium (ether) is considered: the particles of this medium cannot perform translational motion, but have spinor motions. Kelvin could not write the mathematical equations of such motion, because the formulation of the rotation (turn) tensor, a carrier of a spinor motion, was not available at the time. In Zhilin (1996c), the basic equations of this particular Kelvin medium are presented, and it is shown that they present a certain combination of the equations of Klein<sup>26</sup>-Gordon<sup>27</sup> and Schrödinger<sup>28</sup>. At small rotational velocities of particles, the equations of this Kelvin medium are reduced to the equations of Klein-Gordon, and at large velocities to the Schrödinger equation. It is significant that both equations lie in the frame of Quantum Mechanics.

The theory of a non-linear elastic Kelvin medium the particles of which perform translational and rotational motions, with large displacements and rotations, and may freely rotate about their axes of symmetry, has been proposed. The exact analogy is established between the equations for a particular case of Kelvin medium and the equations of elastic ferromagnetic insulators in the approximation of quasimagnetostatics in Grekova and Zhilin (1998, 2000, 2001). It is shown that the existing theories of magnetoelastic materials did not take into account one of the couplings between magnetic and elastic subsystem, which is allowed by fundamental principles. This coupling is important for the description of the magnetoacoustic resonance, and may manifest itself in non-linear theory as well as in the linear one for the case of anisotropic materials.

A special representation of the equations of piezoelectricity are presented in Kolpakov and Zhilin (2002); Zhilin and Kolpakov (2006). These equations contain as particular cases several theories, and two among them are new. The proposed general theory is based on the model of a micro-polar continuum.

### 5.2 Inelastic Media

A general approach for the construction of the theory of inelastic media is proposed in Zhilin (2001a, 2002b); Altenbach et al. (2003b,a); Zhilin (2003a, 2004). The main attention is pointed out to a clear introduction of basic concepts such as strain measures, internal energy, temperature, and chemical potentials. Polar and non-polar media are considered. The originality of the suggested approach is the following. The spatial description is used where the fundamental laws are formulated for open systems. A new handling of the equation of the energy balance is offered, where the entropy and the chemical potential are introduced by means of purely mechanical quantities. The internal energy is given in a form, which is at the same time applicable for gaseous, liquid, and solid states. Phase transitions in the medium are described without introducing any supplementary conditions; a solid-solid phase transition can also be described in these terms. The materials under consideration have a finite tensile strength; this means that the constitutive equations satisfy the condition of the strong ellipticity.

When constructing the general theory of inelastic media there was used the *spatial description*, see Zhilin (2001a, 2002b, 2003a, 2004), where a certain fixed domain of a frame of reference contains different medium particles at

<sup>24</sup>James Clerk Maxwell (1831-1879); Scottish mathematician and theoretical physicist

<sup>25</sup>William Thomson, 1st Baron Kelvin (1824-1907); British mathematical physicist and engineer

<sup>26</sup>Oskar Klein (1894-1977); Swedish theoretical physicist

<sup>27</sup>Walter Gordon (1893-1939); German physicist

<sup>28</sup>Erwin Rudolf Josef Alexander Schrödinger (1887-1961); Austrian physicist

different instants. Due to the use of the spatial description, a theory is constructed where the concept of a smooth differential manifold is not used. Until then, such theories were developed only for fluids. For the first time such a theory is built for solids, where the stress deviator is non-zero. In addition, the spatial description is applied to a medium consisting of particles with rotational degrees of freedom. A new definition of a material derivative, containing only objective operators, is given. This definition, when using a moving co-ordinate system, does not contradict to the Galileo's principle of inertia, see Zhilin (2002b).

A new theory of elasto-plastic bodies is developed in Zhilin (2002b, 2003a). The theory is based on the description of the non-elastic properties by the phase transitions in the materials. The definition of the phase transition is given in the following way. Two material characteristics are related to their densities: the solid fraction, defined as a number of particles in a unit volume on the particle volume, and the porosity (void fraction), defined as a negative solid fraction. A solid has several stable states corresponding to different values of the solid fraction. The transition from one stable state to another is a typical phase transition. A constitutive equation describing the solid fraction changes near the phase transition point is suggested.

### 5.3 Theory of Constitutive Equations of Complex Media

The characteristics of state, corresponding to temperature, entropy, and chemical potential, are presented in Zhilin (2001a, 2002b, 2003a, 2004) from pure mechanical considerations, by means of a special mathematical formulation of the energy balance equation, obtained by a separation of the stress tensors into elastic and dissipative components. The second law of thermodynamics gives additional limitations for the introduced characteristics, and this completes their formal definition. The reduced equation of energy balance is obtained in terms of the free energy. The main purpose of this equation is to determine the arguments on which the free energy depends. It is shown that defining first the internal energy, and then the entropy and chemical potential, is impossible. All these quantities should be introduced simultaneously. To set the relations between the internal energy, entropy, the chemical potential, the pressure, etc., the reduced equation of energy balance is used. It is shown that the free energy is a function of temperature, density of particles, and strain measures, where all these arguments are independent. The Cauchy<sup>29</sup>-Green<sup>30</sup> relations relating entropy, chemical potential and tensors of elastic stresses with temperature, density of particles and measures of deformation are obtained. Hence the concrete definition of the constitutive equations requires the setting of only the free energy. The equations characterizing the role of entropy and chemical potential in the formation of the internal energy are obtained. Constitutive equations for the vector of energy flux are offered in Zhilin (2003a). In a particular case these equations give the analogue of the Fourier<sup>31</sup>-Stokes<sup>32</sup> law.

The micro-polar theory for binary media initiated by Zhilin is developed in Altenbach et al. (2003a,b). The medium consists of liquid drops and fibres. The liquid is assumed to be viscous and non-polar, but with a non-symmetric stress tensor. The fibres are described by non-symmetric tensors of force and couple stresses. The forces of viscous friction are taken into account. The second law of thermodynamics is formulated in the form of two inequalities, where the components of the binary media can have different temperatures.

The general theory of granular media with particles able to join (consolidate) is developed in Zhilin (2001a, 2002b). The particles possess translational and rotational degrees of freedom. For an isotropic material with small displacements and isothermal strains, the theory of consolidating granular media is presented in a closed form in Zhilin (2001a). Instead of the tensor of viscous stresses, which is frequently used in the literature, the antisymmetric stress tensor is introduced in Zhilin (2001a) and for this tensor the Coulomb friction law is applied. For the couple stress tensor the viscous friction law is used.

### Acknowledgement

The authors express special thanks to Marian Wiercigroch (University of Aberdeen) and Konstantin Naumenko (Martin-Luther-Universität Halle-Wittenberg) for the proof reading and critical remarks.

The second author acknowledge the DAAD for the financial support within the program "Forschungsaufenthalte für Hochschullehrer und Wissenschaftler" in 2008.

<sup>29</sup>Augustin Louis Cauchy (1789-1857); French mathematician

<sup>30</sup>George Green (1793-1841); British mathematician and physicist

<sup>31</sup>Jean Baptiste Joseph Fourier (1768-1830); French mathematician and physicist

<sup>32</sup>Sir George Gabriel Stokes, 1st Baronet (1819-1903); Irish mathematician and physicist

## References

- Altenbach, H.: Eine direkt formulierte lineare Theorie für viskoelastische Platten und Schalen. *Ingenieur-Archiv*, 58, 3, (1987), 215–228.
- Altenbach, H.: An alternative determination of transverse shear stiffnesses for sandwich and laminated plates. *Int. J. Solids Struct.*, 37, 25, (2000a), 3503–3520.
- Altenbach, H.: On the determination of transverse shear stiffnesses of orthotropic plates. *ZAMP*, 51, (2000b), 629–649.
- Altenbach, H.; Eremeyev, V. A.: Analysis of the viscoelastic behavior of plates made of functionally graded materials. *ZAMM*, 88, 5, (2008a), 332–341.
- Altenbach, H.; Eremeyev, V. A.: Direct approach based analysis of plates composed of functionally graded materials. *Arch. Appl. Mech.*, 78, 10, (2008b), 775–794.
- Altenbach, H.; Indeitsev, D.; Ivanova, E.; Krivtsov, A.: Editorial - in memory of pavel andreevich zhilin (1942-2005). *ZAMM*, 87, 2, (2007), 79–80.
- Altenbach, H.; Naumenko, K.; Zhilin, P.: A micro-polar theory for binary media with application to flow of fiber suspensions. In: *Proc. of XXX Summer School - Conference "Advanced Problems in Mechanics"*, pages 39–62, St. Petersburg (2003a).
- Altenbach, H.; Naumenko, K.; Zhilin, P.: A micro-polar theory for binary media with application to phase-transitional flow of fiber suspensions. *Continuum Mechanics and Thermodynamics*, 15, 6, (2003b), 539–570.
- Altenbach, H.; Naumenko, K.; Zhilin, P.: A direct approach to the formulation of constitutive equations for rods and shells. In: W. Pietraszkiewicz; C. Szymczak, eds., *Shell Structures - Theory and Application 2005*, pages 87–90, Taylor & Francis/Balkema, London (2005).
- Altenbach, H.; Naumenko, K.; Zhilin, P. A.: A note on transversely-isotropic invariants. *ZAMM*, 86, 2, (2006), 162–168.
- Altenbach, H.; Zhilin, P.: Eine nichtlineare Theorie dünner Dreischichtschalen und ihre Anwendung auf die Stabilitätsuntersuchung eines dreischichtigen Streifens. *Technische Mechanik*, 3, 2, (1982), 23–30.
- Altenbach, H.; Zhilin, P.: The theory of simple elastic shells. In: R. Kienzler; H. Altenbach; I. Ott, eds., *Critical Review of the Theories of Plates and Shells and new Applications*, Lect. Notes Appl. Comp. Mech. 16, pages 1–12, Springer, Berlin (2004).
- Altenbach, H.; Zhilin, P. A.: General theory of elastic simple shells (in Russ.). *Uspekhi Mekhaniki (Advances in Mechanics)*, 11, 4, (1988), 107–148.
- Antman, S. S.: *Nonlinear Problems of Elasticity*. Springer Science Media, New York, 2nd edn. (2005).
- Atkin, R. J.; Crain, R. E.: Continuum theories of mixtures: basic theory and historical development. *Quart. J. Mech. Appl. Math.*, 29, 2, (1976a), 209–244.
- Atkin, R. J.; Crain, R. E.: Continuum theories of mixtures: applications. *J. Institute of mathematics and applications*, 17, 2, (1976b), 153–207.
- Backhaus, G.: *Deformationsgesetze*. Akademie-Verlag, Berlin (1983).
- Billington, E. W.: The Poynting effect. *Acta Mechanica*, 58, (1986), 19–31.
- Bowen, R. M.: Toward a thermodynamics and mechanics of mixtures. *Arch. Rat. Mech. Anal.*, 24, 5, (1967), 370–403.
- Brommundt, E.: Tilt angles. *Technische Mechanik*, 26, 2, (2006), 148–167.
- Chróścielewski, J.; Makowski, J.; Pietraszkiewicz, W.: *Statyka i dynamika powłok wielopłatowych. Nieliniowa teoria i metoda elementów skończonych*. Wydawnictwo IPPT PAN, Warszawa (2004).
- Cohen, H.; Sun, Q. X.: A further work on directed rods. *J. Elast.*, 28, 2, (1992), 123–142.
- Eremeyev, V. A.: Nonlinear micropolar shells: theory and applications. In: W. Pietraszkiewicz; C. Szymczak, eds., *Shell Structures: Theory and Applications*, pages 11–18, Taylor & Francis, London (2005).



- Eremeyev, V. A.; Pietraszkiewicz, W.: The non-linear theory of elastic shells with phase transitions. *J. Elast.*, 74, 1, (2004), 67–86.
- Eremeyev, V. A.; Pietraszkiewicz, W.: Local symmetry group in the general theory of elastic shells. *J. Elast.*, 85, 2, (2006), 125–152.
- Eremeyev, V. A.; Zubov, L. M.: On constitutive inequalities in nonlinear theory of elastic shells. *ZAMM*, 87, 2, (2007), 94–101.
- Eremeyev, V. A.; Zubov, L. M.: *Mechanics of Elastic Shells (in Russ.)*. Nauka, Moscow (2008).
- Ericksen, J. L.; Truesdell, C.: Exact theory of stress and strain in rods and shells. *Arch. Rat. Mech. Anal.*, 1, 1, (1958), 295–323.
- Goloskokov, D. P.; Zhilin, P. A.: General nonlinear theory of elastic rods with application to the description of the Poynting effect (in Russ.). Deposited in VINITI No. 1912-V87 (1987).
- Green, A. E.; F.R.S.; Naghdi, P. M.; Wenner, M. L.: On the theory of rods. II. Developments by direct approach. *Proc. Roy. Soc. Lond. A*, 337, (1973), 485–507.
- Green, A. E.; M., N. P.: Non-isothermal theory of rods, plates and shells. *Int. J. Solids Struct.*, 6, (1970), 209–244.
- Green, A. E.; M., N. P.: On thermal effects in the theory of shells. *Proc. R. Soc. London.*, 365A, (1979), 161–190.
- Green, A. E.; Naghdi, P. M.: The linear elastic Cosserat surface and shell theory. *Int. J. Solids Struct.*, 4, 6, (1968), 585–592.
- Green, A. E.; Naghdi, P. M.: Derivation of shell theories by direct approach. *Trans. ASME. J. Appl. Mech.*, 41, 1, (1974), 173–176.
- Green, A. E.; Naghdi, P. M.; Wainwright, W. L.: A general theory of a Cosserat surface. *Arch. Rat. Mech. Anal.*, 20, 4, (1965), 287–308.
- Grekova, E. F.; Zhilin, P. A.: Ferromagnets and Kelvin’s medium: basic equations and magnetoacoustic resonance. In: *Proc. of the XXV-XXVI Summer Schools “Analysis and synthesis of nonlinear mechanical vibration systems”*, vol. 1, pages 259–281, St. Petersburg (1998).
- Grekova, E. F.; Zhilin, P. A.: Equations for elastic non-linear polar media and analogies: Kelvin medium, non-classical shells, and ferromagnetic insulators (in Russ.). *Izvestiya VUZov. Severo-Kavkazskii region. Estestvennye nauki (Transactions of Universities. South of Russia. Natural sciences)*, Special issue “Nonlinear Problems of Continuum Mechanics”, (2000), 24–46.
- Grekova, E. F.; Zhilin, P. A.: Basic equations of Kelvin’s medium and analogy with ferromagnets. *Journal of Elasticity*, 64, (2001), 29–70.
- Grigolyuk, E. I.; Seleznev, I. T.: Nonclassical theories of vibration of beams, plates and shells (in Russ.). In: *Itogi nauki i tekhniki*, vol. 5 of *Mekhanika tverdogo deformiruemogo tela*, VINITI, Moskva (1973).
- Grigolyuk, E. I.; Kogan, A. F.: Present state of the theory of multilayered shells (in Russ.). *Prikl. Mekh.*, 8, 6, (1972), 3–17.
- Ivanova, E. A.; Zhilin, P. A.: Non-stationary regime of the motion of a rigid body on an elastic plate. In: *Proc. of XXIX Summer School - Conference “Advanced Problems in Mechanics”*, pages 357–363, St. Petersburg (2002).
- Kafadar, C. B.; Eringen, A. C.: Polar field theories. In: A. C. Eringen, ed., *Continuum Physics. Vol. IV*, vol. IV, pages 1–75, Academic Press, New York (1976).
- Kienzler, R.: On consistent plate theories. *Archive of Applied Mechanics (Ingenieur-Archiv)*, 72, 4–5, (2002), 229–247.
- Kolpakov, Y. E.; Zhilin, P. A.: Generalized continuum and linear theory of the piezoelectric materials. In: *Proc. of XXIX Summer School - Conference “Advanced Problems in Mechanics”*, pages 364–375, St. Petersburg (2002).
- Le, X. A.: *Dynamics of Mechanical Systems with Coulomb Friction*. Foundations of Engineering Mechanics, Springer, Berlin (2003).
- Levi-Civita, T.; Amaldi, U.: *Lezioni di Meccanica Razionale*, vol. 2, pt. 1. Zanichelli, Bologna (1926).

- Levi-Civita, T.; Amaldi, U.: *Lezioni di Meccanica Razionale*, vol. 2, pt. 2. Zanichelli, Bologna (1927).
- Libai, A.; Simmonds, J. G.: Nonlinear elastic shell theory. *Adv. Appl. Mech.*, 23, (1983), 271–371.
- Libai, A.; Simmonds, J. G.: *The Nonlinear Theory of Elastic Shells*. Cambridge University Press, Cambridge, 2nd edn. (1998).
- Lurie, A.: *Analytical Mechanics*. Foundations of Engineering Mechanics, Springer, Berlin (2002).
- Makowski, J.; Pietraszkiewicz, W.: *Thermomechanics of Shells with Singular Curves*. Zesz. Nauk. No 528/1487/2002. IMP PAN., Gdańsk (2002).
- Murdoch, A. I.: A thermodynamical theory of elastic material interfaces. *Q. J. Mech. Appl. Math.*, XXIX, 3, (1976a), 245–274.
- Murdoch, A. I.: On the entropy inequality for material interfaces. *ZAMP*, 27, (1976b), 599–605.
- Murdoch, A. I.; Cohen, H.: Symmetry considerations for material surfaces. *Arch. Ration. Mech. Anal.*, 72, (1979), 61–98.
- Murdoch, A. I.; Cohen, H.: Symmetry considerations for material surfaces. Addendum. *Arch. Ration. Mech. Anal.*, 76, 4, (1981), 393–400.
- Naghdi, P.: The theory of plates and shells. In: S. Flügge, ed., *Handbuch der Physik*, vol. VIa/2, pages 425–640, Springer (1972).
- Naghdi, P. M.; Rubin, M. B.: Constrained theories of rods. *J. Elast.*, 14, (1984), 343–361.
- Reissner, E.: Reflection on the theory of elastic plates. *Applied Mechanics Review*, 38, 11, (1985), 1453–1464.
- Rubin, M. B.: *Cosserat Theories: Shells, Rods and Points*. Kluwer, Dordrecht (2000).
- Shkutin, L. I.: *Mechanics of Deformations of Flexible Bodies (in Russ.)*. Nauka, Novosibirsk (1985).
- Simmonds, J. G.: The thermodynamical theory of shells: Descent from 3-dimensions without thickness expansions. In: *Flexible shells, theory and applications*, pages 1–11, Springer, Berlin (1984).
- Simmonds, J. G.: A simple nonlinear thermodynamic theory of arbitrary elastic beams. *J. Elast.*, 81, (2005), 51–62.
- Suslov, G. K.: *Theoretical Mechanics (in Russ.)*. OGIz, Moscow, 3rd edn. (1946).
- Tovstik, P. E.; Tovstik, T. P.: On the 2d models of plates and shells including the transversal shear. *ZAMM*, 87, 2, (2007), 160–171.
- Truesdell, C.: *Rational Thermodynamics*. Springer, New York, 2nd edn. (1984).
- Venatovsky, I. V.; Zhilin, P. A.; Komyagin, D. Y.: Inventor's certificate no. 1490663 with priority from 02.11.1987 (1987).
- Wiercigroch, M.; Zhilin, P. A.: On the Painlevé paradoxes. In: *Proc. of the XXVII Summer School "Analysis and synthesis of nonlinear mechanical vibration systems"*, pages 1–22, St. Petersburg (2000).
- Zhilin, P. A.: Axisymmetric deformation of a cylindrical shell, supported by frames (in Russ.). *Izvestiya AN SSSR. Mekhanika tverdogo tela (Transactions of the Academy of Sciences of the USSR. Mechanics of Solids)*, Nr. 5, (1966), 139–142.
- Zhilin, P. A.: General theory of ribbed shells (in Russ.). *Trudy CKTI (Transactions of Central Boiler Turbine Institute)*, Nr. 88, (1968), 46–70.
- Zhilin, P. A.: Linear theory of ribbed shells (in Russ.). *Izvestiya AN SSSR. Mekhanika tverdogo tela (Transactions of the Academy of Sciences of the USSR. Mechanics of Solids)*, Nr. 4, (1970), 150–162.
- Zhilin, P. A.: Two-dimensional deformable continuum. Mathematical theory and physical interpretations (in Russ.). *Izvestiya AN SSSR. Mekhanika tverdogo tela (Transactions of the Academy of Sciences of the USSR. Mechanics of Solids)*, Nr. 6, (1972), 207–208.
- Zhilin, P. A.: Mechanics of deformable enriched surfaces (in Russ.). In: *Transactions of the 9th Soviet conference on the theory of shells and plates*, pages 48–54, Sudostroenie, Leningrad (1975a).

- Zhilin, P. A.: Mechanics of deformable surfaces. Report Nr. 89, The Danish Center for Appl. Math. and Mech. (1975b).
- Zhilin, P. A.: Mechanics of deformable directed surfaces. *Int. J. Solids & Structures*, 12, (1976), 635–648.
- Zhilin, P. A.: General theory of constitutive equations in the linear theory of elastic shells (in Russ.). *Izvestiya AN SSSR. Mekhanika tverdogo tela (Transactions of the Academy of Sciences of the USSR. Mechanics of Solids)*, Nr. 3, (1978), 190.
- Zhilin, P. A.: Axisymmetric bending of a flexible circular plate under large displacements (in Russ.). In: *Trudy LPI (Trans. Leningrad Polytechnical Institute) - Vichislitelnie metodi v mekhanike i upravlenii (Numerical methods in mechanics and control theory)*, Nr. 388, pages 97–106, Leningrad Polytechnical Institute (1982a).
- Zhilin, P. A.: Basic equations of non-classical theory of shells (in Russ.). In: *Trudy LPI (Trans. Leningrad Polytechnical Institute) - Dinamika i prochnost mashin (Dynamics and strength of machines)*, Nr. 386, pages 29–46, Leningrad Polytechnical Institute (1982b).
- Zhilin, P. A.: Axisymmetrical bending of a circular plate under large displacements (in Russ.). *Izvestiya AN SSSR. Mekhanika tverdogo tela (Transactions of the Academy of Sciences of the USSR. Mechanics of Solids)*, Nr. 3, (1984), 138–144.
- Zhilin, P. A.: The turn-tensor in description of the kinematics of a rigid body (in Russ.). In: *Trudy SPbGTU (Trans. of St. Petersburg State Technical University) - Mekhanika i processy upravleniya (Mechanics and Control Processes)*, Nr. 443, pages 100–121, St. Petersburg State Technical University (1992a).
- Zhilin, P. A.: The view on Poisson's and Kirchhoff's theories of plates in terms of modern theory of plates (in Russ.). *Izvestiya RAN. Mekhanika tverdogo tela (Transactions of the Russian Academy of Sciences. Mechanics of Solids)*, Nr. 3, (1992b), 48–64.
- Zhilin, P. A.: The relativistic principle of Galilei and the Maxwell's equations (in Russ.). St. Petersburg State Technical University, St. Petersburg (1993).
- Zhilin, P. A.: Main structures and laws of rational mechanics (in Russ.). In: *Proc. of the 1st Soviet Union Meeting for Heads of Departments of Theoretical Mechanics*, pages 23–45, VIKI, St. Petersburg (1994a).
- Zhilin, P. A.: The relativistic principle of Galilei and the Maxwell's equations (in Russ.). In: *Trudy SPbGTU (Trans. of St. Petersburg State Technical University) - Mekhanika i processy upravleniya (Mechanics and Control Processes)*, Nr. 448, pages 3–38, St. Petersburg State Technical University (1994b).
- Zhilin, P. A.: A new approach to the analysis of Euler-Poinsot problem. *ZAMM*, 75, S1, (1995a), 133–134.
- Zhilin, P. A.: Basic concepts and fundamental laws of rational mechanics (in Russ.). In: *Proc. of XXII Summer School - Seminar "Analysis and synthesis of nonlinear mechanical vibration systems"*, pages 10–36, St. Petersburg (1995b).
- Zhilin, P. A.: On the classical theory of plates and the Kelvin-Tait transformation (in Russ.). *Izvestiya RAN. Mekhanika tverdogo tela (Transactions of the Russian Academy of Sciences. Mechanics of Solids)*, Nr. 4, (1995c), 133–140.
- Zhilin, P. A.: Spin motions and stability of equilibrium configurations of thin elastic rods (in Russ.). In: *Trudy SPbGTU (Trans. of St. Petersburg State Technical University) - Mekhanika i processy upravleniya (Mechanics and Control Processes)*, Nr. 458, pages 56–73, St. Petersburg State Technical University (1995d).
- Zhilin, P. A.: Classical and modified electrodynamics (in Russ.). In: *Proc. of Int. Conf. "New Ideas in Natural Sciences"*, vol. I - Physics, pages 73–82, St. Petersburg (1996a).
- Zhilin, P. A.: A new approach to the analysis of free rotations of rigid bodies. *ZAMM*, 76, 4, (1996b), 187–204.
- Zhilin, P. A.: Reality and mechanics (in Russ.). In: *Proc. of XXII Summer School - Seminar "Analysis and synthesis of nonlinear mechanical vibration systems"*, pages 6–49, St. Petersburg (1996c).
- Zhilin, P. A.: Rotations of rigid body with small angles of nutation. *ZAMM*, 76, S2, (1996d), 711–712.
- Zhilin, P. A.: Classical and modified electrodynamics (in Russ.). In: *Proc. of the IV International Conference "Problems of Space, Time, and Motion" dedicated to the 350th anniversary of Leibniz*, vol. 2, pages 29–42, St. Petersburg (1997a).

- Zhilin, P. A.: Dynamic forms of equilibrium bar compressed by a dead force. In: *Proc. of 1st Int. Conf. Control of Oscillations and Chaos*, vol. 3, pages 399–402 (1997b).
- Zhilin, P. A.: Dynamics and stability of equilibrium positions of a rigid body on an elastic foundation (in Russ.). In: *Proc. of XXIV Summer School - Seminar "Analysis and synthesis of nonlinear mechanical vibration systems"*, pages 90–122, St. Petersburg (1997c).
- Zhilin, P. A.: A general model of rigid body oscillator (in Russ.). In: *Proc. of the XXV-XXVI Summer Schools "Analysis and synthesis of nonlinear mechanical vibration systems"*, vol. 1, pages 288–314, St. Petersburg (1998).
- Zhilin, P. A.: Dynamics of the two rotors gyrostat on a nonlinear elastic foundation. *ZAMM*, 79, S2, (1999), 399–400.
- Zhilin, P. A.: Rigid body oscillator: a general model and some results. *Acta Mechanica*, 142, (2000), 169–193.
- Zhilin, P. A.: Basic equations of the theory of non-elastic media (in Russ.). In: *Proc. of XXVIII Summer School - Conference "Advanced Problems in Mechanics"*, pages 14–58, St. Petersburg (2001a).
- Zhilin, P. A.: *Theoretical Mechanics (in Russ.)*. St. Petersburg State Polytechnical University (2001b).
- Zhilin, P. A.: *Vectors and Second-rank Tensors in Three-dimensional Space (in Russ.)*. St. Petersburg State Polytechnical University (2001c).
- Zhilin, P. A.: Basic postulates of the Eulerian mechanics (in Russ.). In: *Proc. of XXIX Summer School - Conference "Advanced Problems in Mechanics"*, pages 641–675, St. Petersburg (2002a).
- Zhilin, P. A.: Phase Transitions and General Theory of Elasto-Plastic Bodies. In: *Proc. of XXIX Summer School - Conference "Advanced Problems in Mechanics"*, pages 36–48, St. Petersburg (2002b).
- Zhilin, P. A.: Mathematical theory of inelastic media (in Russ.). *Uspekhi mekhaniki (Advances in mechanics)*, 2, 4, (2003a), 3–36.
- Zhilin, P. A.: Modified theory of symmetry for tensors and their invariants. *Izvestiya VUZov. Severo-Kavkazskii region. Estestvennyye nauki (Transactions of Universities. South of Russia. Natural sciences). Special issue "Non-linear Problems of Continuum Mechanics"*, Special issue "Natural Sciences", (2003b), 176–195.
- Zhilin, P. A.: *Theoretical Mechanics. Fundamental Laws of Mechanics (in Russ.)*. St. Petersburg State Polytechnical University, St. Petersburg (2003c).
- Zhilin, P. A.: On the general theory of non-elastic media (in Russ.). In: *Trudy SPbGTU (Trans. of St. Petersburg State Technical University) - Mekhanika materialov i prochnost' konstrukcii (Mechanics of materials and strength of structural elements)*, Nr. 489, pages 8–27, St. Petersburg State Technical University (2004).
- Zhilin, P. A.: Symmetries and orthogonal invariants in oriented space. In: *Proc. of XXXII Summer School - Conference "Advanced Problems in Mechanics"*, pages 470–483, St. Petersburg (2005).
- Zhilin, P. A.: *Applied Mechanics. Foundations of the Theory of Shells (in Russ.)*. St. Petersburg State Polytechnical University (2006a).
- Zhilin, P. A.: *Applied Mechanics. Theory of Thin Elastic Rods (in Russ.)*. St. Petersburg State Polytechnical University (2006b).
- Zhilin, P. A.: Nonlinear theory of thin rods. In: D. A. Indeitsev; E. A. Ivanova; A. M. Krivtsov, eds., *Advanced Problems in Mechanics*, vol. 2, pages 227–249, Institute for Problems in Mechanical Engineering of Russian Academy of Sciences, St. Petersburg (2006c).
- Zhilin, P. A.: Rotation of a rigid body with a fixed point: the Lagrange case (in Russ.). In: D. A. Indeitsev; E. A. Ivanova; A. M. Krivtsov, eds., *Advanced Problems in Mechanics*, vol. 1, pages 241–255, Institute for Problems in Mechanical Engineering of Russian Academy of Sciences, St. Petersburg (2006d).
- Zhilin, P. A.: The main direction of the development of mechanics for XXI century. In: D. A. Indeitsev; E. A. Ivanova; A. M. Krivtsov, eds., *Advanced Problems in Mechanics*, vol. 2, pages 112–125, Institute for Problems in Mechanical Engineering of Russian Academy of Sciences, St. Petersburg (2006e).

- Zhilin, P. A.: Theory of thin elastic rods (in Russ.). In: D. A. Indeitsev; E. A. Ivanova; A. M. Krivtsov, eds., *Advanced Problems in Mechanics*, vol. 1, pages 256–297, Institute for Problems in Mechanical Engineering of Russian Academy of Sciences, St. Petersburg (2007).
- Zhilin, P. A.; Il'icheva, T. A.: Oscillation spectra and forms of a rectangular parallelepiped obtained by the three-dimensional theory of elasticity and the theory of shells (in Russ.). *Izvestiya AN SSSR. Mekhanika tverdogo tela (Transactions of the Academy of Sciences of the USSR. Mechanics of Solids)*, Nr. 2, (1980), 94–103.
- Zhilin, P. A.; Il'icheva, T. A.: Applicability of Timoshenko-type theories to localized plate loading (in Russ.). *Zhurnal Prikladnoi Mekhaniki i Tekhnicheskoi Fiziki (Journal of Applied Mechanics and Technical Physics)*, 25, 1, (1984), 135–140.
- Zhilin, P. A.; Kolpakov, Y. E.: A micro-polar theory for piezoelectric materials. In: D. A. Indeitsev; E. A. Ivanova; A. M. Krivtsov, eds., *Advanced Problems in Mechanics*, vol. 2, pages 250–261, Institute for Problems in Mechanical Engineering of Russian Academy of Sciences, St. Petersburg (2006).
- Zhilin, P. A.; Konyushevskaya, R. M.; Palmov, V. A.; Chvartatsky, R. V.: On design of the stress-strain state of discharge chambers of Tokamak panels (in Russ.). P-OM-0550 1–13, NIIIEFA (Research Institute of Electro-physical Apparatus), Leningrad (1982).
- Zhilin, P. A.; Mikheev, V. I.: Toroidal shell with meridional ribs for design of hydroturbine spirals (in Russ.). *Trudy CKTI (Transactions of Central Boiler Turbine Institute)*, Nr. 88, (1968), 91–99.
- Zhilin, P. A.; Sergeyev, A. D.: Experimental investigation of the stability of a cantilever rod under torsion (in Russ.). In: *Trudy SPbGTU (Trans. of St. Petersburg State Technical University) - Mekhanika i processy upravleniya (Mechanics and Control Processes)*, Nr. 446, pages 174–175, St. Petersburg State Technical University (1993a).
- Zhilin, P. A.; Sergeyev, A. D.: Twisting of an elastic cantilever rod by a torque subjected at a free end (in Russ.). St. Petersburg State Technical University, St. Petersburg (1993b).
- Zhilin, P. A.; Sergeyev, A. D.: Equilibrium and stability of a thin rod subjected to a conservative moment (in Russ.). In: *Trudy SPbGTU (Trans. of St. Petersburg State Technical University) - Mekhanika i processy upravleniya (Mechanics and Control Processes)*, Nr. 448, pages 47–56, St. Petersburg State Technical University (1994).
- Zhilin, P. A.; Sergeyev, A. D.; Tovstik, T. P.: Nonlinear theory of rods and its application (in Russ.). In: *Proc. of XXIV Summer School - Seminar "Analysis and synthesis of nonlinear mechanical vibration systems"*, pages 313–337, St. Petersburg (1997).
- Zhilin, P. A.; Skvorcov, V. R.: Description of the simple edge effect by shell theory and by the three-dimensional theory of elasticity (in Russ.). *Izvestiya AN SSSR. Mekhanika tverdogo tela (Transactions of the Academy of Sciences of the USSR. Mechanics of Solids)*, Nr. 5, (1983), 134–144.
- Zhilin, P. A.; Sorokin, S. A.: The motion of gyrostat on nonlinear elastic foundation. *ZAMM*, 78, S2, (1998), 837–838.
- Zhilin, P. A.; Tovstik, T. P.: Rotation of a rigid body based on an inertial rod (in Russ.). In: *Trudy SPbGTU (Trans. of St. Petersburg State Technical University) - Mekhanika i processy upravleniya (Mechanics and Control Processes)*, Nr. 458, pages 78–83, St. Petersburg State Technical University (1995).
- Zhilin, P. A.; Zhilina, O. P.: On the Coulomb's laws of friction and the Painlevé paradoxes (in Russ.). In: *Trudy SPbGTU (Trans. of St. Petersburg State Technical University) - Mekhanika i processy upravleniya (Mechanics and Control Processes)*, Nr. 446, pages 52–81, St. Petersburg State Technical University (1993).
- Zubov, L. M.: *Nonlinear Theory of Dislocations and Disclinations in Elastic Bodies*. Springer, Berlin (1997).
- Zubov, L. M.: Semi-inverse solutions in nonlinear theory of elastic shells. *Arch. Mech.*, 53, 4-5, (2001), 599–610.

---

*Addresses:* Prof. Dr.-Ing.habil. Holm Altenbach, Lehrstuhl für Technische Mechanik, Zentrum für Ingenieurwissenschaften, Martin-Luther-Universität Halle-Wittenberg, 06099 Halle, Germany; Prof. Dr. Victor A. Eremeyev, South Scientific Center, Russian Academy of Sciences, Chekhova st., 41, Rostov-on-Don, 344006, Russia; Prof. Dr. Dmitry A. Indeitsev, Institute for Problems in Mechanical Engineering, Russian Academy of Sciences, Bolshoy pr. V. O., 61, St. Petersburg, 199178, Russia; Prof. Dr. Elena A. Ivanova & Prof. Dr. Anton M. Krivtsov, Dep. of Theoretical Mechanics, Faculty of Physics and Mechanics, St. Petersburg State Polytechnical University, Polytekhnicheskaya St. 29, 195251 St. Petersburg, Russia  
Corresponding author's email: holm.altenbach@iw.uni-halle.de, ivanova@ei5063.spb.edu