



HAL
open science

Coupling between PEEC and magnetic moment method

Tung Le Duc, Olivier Chadebec, Jean-Michel Guichon, Gérard Meunier, Yves
Lembeye

► **To cite this version:**

Tung Le Duc, Olivier Chadebec, Jean-Michel Guichon, Gérard Meunier, Yves Lembeye. Coupling between PEEC and magnetic moment method. COMPEL: The International Journal for Computation and Mathematics in Electrical and Electronic Engineering, 2013, 32 (1), pp.383-395. 10.1108/03321641311293948 . hal-00821833

HAL Id: hal-00821833

<https://hal.science/hal-00821833v1>

Submitted on 27 Jan 2021

HAL is a multi-disciplinary open access archive for the deposit and dissemination of scientific research documents, whether they are published or not. The documents may come from teaching and research institutions in France or abroad, or from public or private research centers.

L'archive ouverte pluridisciplinaire **HAL**, est destinée au dépôt et à la diffusion de documents scientifiques de niveau recherche, publiés ou non, émanant des établissements d'enseignement et de recherche français ou étrangers, des laboratoires publics ou privés.

Coupling between PEEC and magnetic moment method

Tung Le-Duc, Olivier Chadebec, Jean-Michel Guichon,
G rard Meunier and Yves Lembeey

*Grenoble Electrical Engineering Laboratory (G2Elab), Grenoble University,
Saint Martin d'H res, France*

Abstract

Purpose – The aim of this paper is to model time-harmonic problems in unbounded domains with coils of complex geometry and ferromagnetic materials.

Design/methodology/approach – The approach takes the form of a coupling between two integrals methods: the magnetic moment method (MMM) and the partial element equivalent circuit (PEEC) method. The modeling of conductor system is achieved thanks to PEEC method while the MMM method is considered for the magnetic material.

Findings – The paper shows how to use the MMM/PEEC coupled method to model a problem comprising conductors and ferromagnetic materials and compare its results with the FEM and the FEM/PEEC coupling.

Originality/value – The two methods PEEC and MMM are well-known. The innovation here is coupling these methods in order to take advantages from both methods. Moreover, the performances of this coupling are studied in comparison with others (FEM, FEM/PEEC coupling).

Keywords PEEC method, Magnetic moment method, Integral volume equation, Coupling, Electromagnetic fields, Modelling

Paper type Research paper

1. Introduction

The partial element equivalent circuit (PEEC) method is a semi-analytic method proposed by Ruehli (1974). This method is mainly used for the modeling of complex interconnections and can be applied to a large range of devices where the air region is dominant (printed circuits, bus bars, etc.) (Clavel *et al.*, 2002). However, the classical PEEC method does not enable the 3D modeling of ferromagnetic materials widely present in many devices (ferromagnetic shielding, disruptive magnetic masses, cores of inductance, etc.).

The magnetic moments method is a well-known method to model ferromagnetic devices (Harrington, 1968; Chadebec *et al.*, 2006; Takahashi *et al.*, 2007). It is particularly well adapted to lightly model magnetic materials with simple geometry. Like in the PEEC method, it does not require the meshing of the air region. Only ferromagnetic materials are discretized and often with coarse subdivisions. It leads to high-speed resolutions and to high accuracies for field computations. However, this formulation is a steady state one and quasi-static effects are not modeled in the method especially in conductors. On the other hand, the PEEC method is perfectly dedicated to achieve this task. So, it seems natural to take advantages of the complementarities of both approaches by coupling them. The introduction of ferromagnetic material in

PEEC method has been proposed in Antonini *et al.* (2006) but a study dealing with the performances of the method in comparison with others has not been published yet. Moreover, in this initial paper, a special care is given to the preservation of the topology of PEEC elementary circuit. In this paper, we prefer to adopt a more classical point of view, our goal being to study this new formulation in terms of modeling performances (accuracy, CPU time, memory space, etc.) without considering the problem of spice-like model extraction.

In this paper, the magnetic moment method (MMM)/PEEC coupling in order to perform the efficient global electromagnetic simulation of complex structures incorporating magneto-harmonic conductors and ferromagnetic material is presented (Figure 1). The modeling of non-conductive ferromagnetic regions is achieved thanks to the MMM. The PEEC method allows modeling the contributions of inductors fed with alternating currents. Both approaches will be explained (Sections 2 and 3). Coupling formulations to compute the interaction between conductors and ferromagnetic material will be fully developed in Section 4. Finally, two numerical examples are presented in Section 5. Results given by such method are compared with those given by the single finite element method (FEM) and another coupling already proposed in the literature: FEM/PEEC coupling (Tran *et al.*, 2008, 2010). Strong and weak points of each formulation are analyzed.

2. Magnetic moment method

Let us consider a volume composed of ferromagnetic material with unknown magnetization \mathbf{M} placed in a given static inductor field \mathbf{H}_0 . The ferromagnetic material is meshed into n volume elements. Magnetization is assumed to be uniform in each element i and its value is \mathbf{M}_i .

The total magnetic field \mathbf{H} is the sum of \mathbf{H}_0 and the demagnetizing field created by the whole volume V . This demagnetizing field can be expressed thanks a well-known integral volume equation (Chadebec *et al.*, 2006). The discretization of this integral equation leads to:

$$\mathbf{H}(P) = \mathbf{H}_0(P) + \frac{1}{4\pi} \sum_{i=1}^n \int_{V_i} \left(\frac{3(\mathbf{M}_i \cdot \mathbf{r})}{r^5} \mathbf{r} - \frac{\mathbf{M}_i}{r^3} \right) dV \quad (1)$$

where P is a point located everywhere in the domain region, \mathbf{r} is the vector between the integration point and the point P where the field is expressed, V_i is the volume of

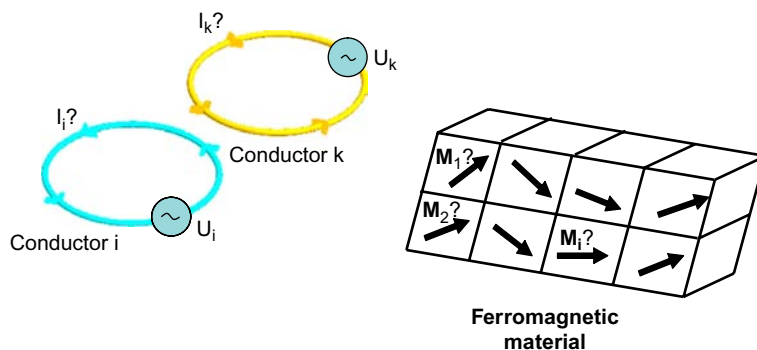

Figure 1.
Representation of a
general problem with
conductors and
ferromagnetic material

ferromagnetic element i . If we define an orthogonal vector basis in each volume element in order to project the magnetization and fields, as equation (1) is linear, it can be re-written as follows:

$$\mathbf{H}(P) = \mathbf{H}_0(P) + \mathbf{f} \cdot \mathbf{M} \quad (2)$$

where \mathbf{M} is a $(3n \times 1)$ vector define magnetizations in each local basis, \mathbf{f} is a $(3 \times 3n)$ matrix.

Let us assume that the magnetization law of the material is linear and associated to a constant susceptibility χ_r . Thanks to a point matching approach at the center of each element, we get a linear matrix system to solve (Chadebec *et al.*, 2006):

$$(\mathbf{I}_d/\chi_r - \mathbf{F}) \cdot \mathbf{M} = \mathbf{h}_0 \quad (3)$$

with \mathbf{M} a $3n$ unknowns component vector to determine and where \mathbf{I}_d is the identity matrix; \mathbf{h}_0 is the source fields at each barycenter projected in local basis and \mathbf{F} is a $(3n \times 3n)$ matrix. If we compute the influence of element j at the barycenter of element i , the coefficient \mathbf{F}_{ij} can be expressed as follows:

$$\mathbf{F}_{ij} = \left\langle \left(\frac{1}{4\pi} \int_{V_j} \left(\frac{3(\mathbf{u}_j \cdot \mathbf{r}_{ij})}{r_{ij}^5} \mathbf{r}_{ij} - \frac{\mathbf{u}_j}{r_{ij}^3} \right) dV_j \right), \mathbf{u}_i \right\rangle \quad (4)$$

where \langle, \rangle denotes the classical scalar product operator and \mathbf{u}_i is the vector basic of element i . Let us notice that equation (4) is a (3×3) matrix for volume element.

System (3) is solved to obtain the magnetization of each ferromagnetic element. This method is usually called MMM. If the material law is non linear, a Newton-Raphson algorithm can be easily used (Ellemaume *et al.*, 1997). Let us notice that this formulation suffers from well-known drawback if the susceptibility of the material is high. Indeed, in such cases, the identity matrix term becomes very low in comparison with \mathbf{F} matrix which is most part of time singular. This problem mainly appears when closed magnetic circuits are modeled; however this method leads to accurate results if simple magnetic volume shapes are considered. It should be pointed out that for the linear case, more simple formulations can be used. If the susceptibility is constant, Laplace equation applies in the whole material volume. Magnetostatic equations can be accurately solved by an integral equation governed by charge distributions (Coulombian approach) or current distributions (Amperian approach) located only on the surface delimiting the volume V . In such configuration, only this surface has to be meshed and not the volume like in the proposed formulation. It results in lower degrees of freedom in the obtained matrix system. The coupling of this kind of surface integral formulation and the PEEC approach has been recently proposed for the Coulombian approach in Kovacevic *et al.* (2011) but in a less general way than in this paper and for the Amperian approach in Keradec *et al.* (2005) but limited to 2D problem. It must be pointed out that both proposed methods in these papers are strongly limited to linear case. Even if all the results presented in this work deals with linear material, we preferred to use volume integral equation enabling the future introduction of non-linear material in our models.

3. PEEC method

Let us consider m volume conductors fed with alternating sources placed in a surrounding air region without any magnetic materials. The well-known PEEC

method is particularly reliable to solve this kind of problem. It is based on the determination of partial voltage generated on each conductor by electromagnetic sources. To compute these voltages, volume integration on the considered conductor of the magnetic vector potential created by all other conductor is provided (Ruehli, 1974; Wollenberg and Kochetov, 2011). Let us assume that the current density in each conductor is uniform. The expression of the magnetic vector potential \mathbf{A}_j created by conductor j is:

$$\mathbf{A}_j(P) = \frac{\mu_0}{4\pi} \frac{I_j}{S_j} \int_{V_j} \frac{\mathbf{l}_j}{r} dV_j \quad (5)$$

where r is the distance between the integration point and the point P , I_j is the current in the conductor j , S_j is the cross-section of the current flow and V_j is the volume of conductor and \mathbf{l}_j is the unit vector oriented in the direction of current I_j .

The flux created by I_j through the conductor k is calculated with:

$$\begin{aligned} \Phi_{kj} &= \frac{1}{S_k} \int_{V_k} \mathbf{A}_j \cdot \mathbf{l}_k dV_k \\ &= \frac{\mu_0}{4\pi} \frac{I_j}{S_j S_k} \int_{V_k} \int_{V_j} \frac{\mathbf{l}_j \cdot \mathbf{l}_k}{r} dV_j dV_k \end{aligned} \quad (6)$$

The mutual inductance between the two conductors is defined by:

$$m_{kj} = \frac{\Phi_{kj}}{I_j} = \frac{\mu_0}{4\pi} \frac{1}{S_j S_k} \int_{V_k} \int_{V_j} \frac{\mathbf{l}_j \cdot \mathbf{l}_k}{r} dV_j dV_k \quad (7)$$

The partial mutual inductance m_{kj} only depends on the dimensions and positions of conductor k and j , and, thus, it can be calculated by well-known analytic formulas (Clavel *et al.*, 2002; Roudet *et al.*, 2004).

Thus, the voltage appearing on the conductor k is given by:

$$U_{k_cond} = I_k R_k + j\omega \sum_{j=1}^m I_j m_{kj} \quad (8)$$

where ω is the angular frequency, R_k is the resistance of k th conductor. Equation (8) links partial voltages of conductors to currents flowing in them. Writing this equation for all passive and active conductors, we get a matrix system known as impedance matrix system:

$$\mathbf{Z} \cdot \mathbf{I} = \mathbf{U} \quad (9)$$

where \mathbf{Z} is a $(m \times m)$ matrix, \mathbf{I} is a $(m \times 1)$ vector and \mathbf{U} is a $(m \times 1)$ vector.

4. Coupling PEEC method with MMM method

Let us consider a system composed of ferromagnetic material with unknown magnetization \mathbf{M} placed in a magnetic field created by m conductors fed with non-static but now unknown alternating currents. The ferromagnetic material is meshed into n volume elements and magnetization is assumed to be uniform in each element like in Section 2 (Figure 1).

In such configuration, the interactions between each ferromagnetic element are calculated thanks the MMM. The PEEC method is used to model interconnection between conductors. It remains to write explicitly the couplings matrix between both formulations (Le Duc *et al.*, 2009; Mokhtari *et al.*, 2010).

4.1 Influence of current conductor in ferromagnetic material

The term \mathbf{h}_0 of equation (3) can be computed by Biot and Savart law. The magnetic field created by m conductors is given by:

$$\mathbf{H}_0(P) = \sum_{j=1}^m \frac{1}{4\pi} \frac{I_j}{S_j} \int_{V_j} \frac{\mathbf{l}_j \times \mathbf{r}}{r^3} dV_j \quad (10)$$

where P is a point located everywhere in the domain region, \mathbf{r} is the vector between the integration point and the point P where the field is expressed, V_j is the volume of j th conductor and \mathbf{l}_j is the unit vector whose direction is the direction of conventional current I_j .

We write equation (10) at barycenter of each ferromagnetic element to obtain a matrix block:

$$\mathbf{h}_0 = \mathbf{BS} \cdot \mathbf{I} \quad (11)$$

where \mathbf{I} is a $(m \times 1)$ vector and \mathbf{BS} is a $(3n \times m)$ matrix. If we compute the magnetic field of conductor j at the barycenter of ferromagnetic element i , the coefficient \mathbf{BS}_{ij} will have the following expression:

$$\mathbf{BS}_{ij} = \frac{1}{4\pi} \frac{1}{S_j} \int_{V_j} \frac{\mathbf{l}_j \times \mathbf{r}_{ij}}{r_{ij}^3} dV_j \quad (12)$$

where \mathbf{r}_{ij} is the vector between the integration point and the barycenter of ferromagnetic element i . Let us notice that equation (12) is a (3×1) vector.

We substitute equation (11) into equation (3) and obtain:

$$(\mathbf{I}_d / \chi_r - \mathbf{F}) \cdot \mathbf{M} - \mathbf{BS} \cdot \mathbf{I} = 0 \quad (13)$$

4.2 Influence of ferromagnetic material magnetization on conductors

Equation (5) has to be modified in order to take into account the influence of the field created by the ferromagnetic materials. Like in the standard PEEC method, we have to integrate the magnetic vector potential \mathbf{Am}_i created by each magnetized elements i on the volume of conductor k . The expression of this magnetic vector potential is:

$$\mathbf{Am}_i(P) = \frac{\mu_0}{4\pi} \int_{V_i} \frac{\mathbf{M}_i \times \mathbf{r}}{r^3} dV_i \quad (14)$$

where \mathbf{r} is the vector between the integration point and the point P , V_i is the volume of ferromagnetic element i . The magnetization being uniform in V_i , equation (14) can be re-written as:

$$\mathbf{Am}_i(P) = \frac{\mu_0}{4\pi} \int_{S_i} \frac{-[\mathbf{n}_i \times \mathbf{M}_i]}{r} dS_i \quad (15)$$

where S_i is the boundary surface of element i and \mathbf{n}_i are its external normal. The flux created by \mathbf{M}_i through the conductor k is then given by:

$$\Phi_{ki} = \frac{1}{S_k} \int_{V_k} \mathbf{A} \mathbf{m}_i \cdot \mathbf{l}_k dV_k \quad (16)$$

where V_k is the volume of conductor k , \mathbf{l}_k is the unit vector oriented in the direction of the flowing current and S_k is the cross-section of the conductor. Let us define \mathbf{u}_i as a vector basis of magnetizations. Thus, equation (16) can be re-written as:

$$\Phi_{ki} = \frac{\mu_0}{4\pi} \frac{M_i}{S_k} \int_{V_k} \int_{S_i} \frac{-[\mathbf{n}_i \times \mathbf{u}_i]}{r} dS_i \mathbf{l}_k dV_k \quad (17)$$

We define mf_{ki} as the mutual inductance between the magnetization M_i of ferromagnetic element and the conductor k . Its expression is:

$$mf_{ki} = \frac{\Phi_{ki}}{M_i} = \frac{\mu_0}{4\pi} \frac{1}{S_k} \int_{V_k} \int_{S_i} \frac{-[\mathbf{n}_i \times \mathbf{u}_i]}{r} dS_i \mathbf{l}_k dV_k \quad (18)$$

Let us notice that the mutual mf_{ki} only depends on relative dimensions and positions of conductor k and ferromagnetic element i . It must be pointed out that equation (18) is equivalent to the mutual inductance between an equivalent surface conductor S_i carrying a tangential current and a volume one V_k . Analytical expressions of this mutual can be found in Roudet *et al.* (2004). A new voltage has to be defined, not generated by the current but by the magnetization:

$$Uf_k = j\omega \sum_{i=1}^{3n} M_i \cdot mf_{ki} \quad (19)$$

The total voltage of the conductor k is given by:

$$U_k = I_k R_k + j\omega \left(\sum_{j=1}^m I_j \cdot m_{kj} + \sum_{i=1}^{3n} M_i \cdot mf_{ki} \right) \quad (20)$$

If we write this equation for all conductors, we get a new impedance matrix system:

$$\mathbf{U} = \mathbf{Z} \cdot \mathbf{I} + \mathbf{L}_{mat} \cdot \mathbf{M} \quad (21)$$

Finally, equations (13) and (21) are brought together in a global square $(3n + m) \times (3n + m)$ following matrix system:

$$\begin{bmatrix} \mathbf{MMM} & -\mathbf{BS} \\ \mathbf{L}_{mat} & \mathbf{Z} \end{bmatrix} \times \begin{bmatrix} \mathbf{M} \\ \mathbf{I} \end{bmatrix} = \begin{bmatrix} \mathbf{0} \\ \mathbf{U} \end{bmatrix} \quad (22)$$

where \mathbf{MMM} is the standard magnetic moment matrix ($\mathbf{MMM} = \mathbf{I}_d' \chi_r - \mathbf{F}$, see equation (3)), \mathbf{BS} is the Biot and Savart integral term, \mathbf{Z} is the classical inductive and resistive PEEC matrix, \mathbf{L}_{mat} is the mutual magnetic matrix.

Besides, by taking into account circuit equations, it is possible to reduce equation (22) to get a more simple system and to solve it to get magnetizations and currents in conductors.

Let us notice that a non-linear equivalent permeability can be used for a non-linear material (Vassent *et al.*, 1989).

5. Numerical examples

In this section, we consider two numerical examples. For both, three numerical methods are compared. The first one is a scalar magnetic potential FEM formulation coupled with circuit equations in FLUX3D software (Le Floch *et al.*, 2003). In this modeling, a special care is given to the mesh around conductors to ensure accurate results. The second one is a coupling between PEEC to model inductances and FEM to take into account the ferromagnetic material (FEM/PEEC coupling). This approach has already shown its good accuracy with a reduced number of elements in comparison with standard FEM (Tran *et al.*, 2008). The last one is the considered MMM/PEEC coupling.

5.1 Validation on a simple example

In the first example, two coils are considered with a ferromagnetic bar (dimension $75 \times 75 \times 80$ mm, $\mu_r = 1,000$) placed between them (Figure 2). The first conductor is fed by a voltage source (1V, 1 kHz). The second one is a passive loop. To compare different approaches, we focus on the computed current in the second coil and the magnetic field in the air region close to the device (calculated on the same line 1 in Figure 2) with different meshes for the three approaches.

The problem needs a very fine mesh to be accurately solved with FEM (Table I and Figure 3) because of the high variation of the field created by the conductor (Tran *et al.*, 2008). The currents values strongly vary according to the number of elements. On the contrary, the convergence is quickly reached with the FEM/PEEC coupling because of the accurate computation of conductor effect thanks to the PEEC method. In such modeling, the mesh refinement around conductors is dispensable.

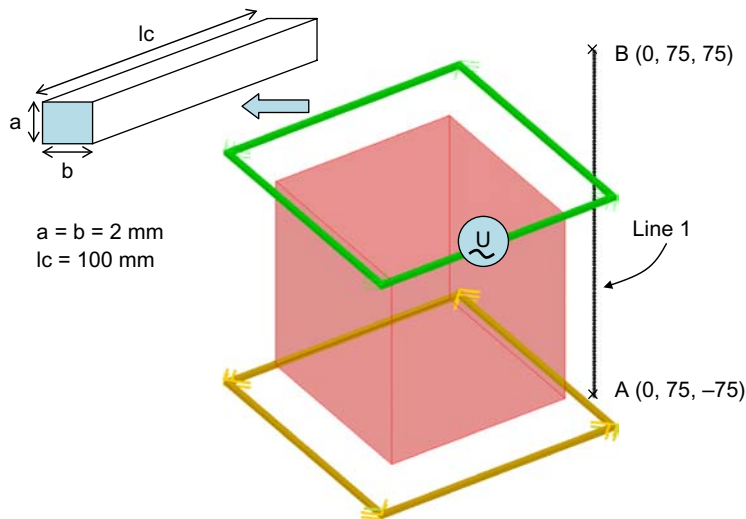

Figure 2.
Geometry of the first example

Results of the MMM/PEEC hybrid approach are similar to those of both FEM and FEM/PEEC methods. We can notice small differences between current computed values (0.06 percent with FEM/PEEC and 0.3 percent with FEM, see Table I). Thus, results provided by the coupling are very encouraging, not only the coupling gives stable results but also it needs very less considerably memory space than the FEM and FEM/PEEC method. Of course, the obtained matrix is fully dense, but the CPU time is reduced up to a factor of 100 in comparison with FEM and of ten with FEM/PEEC (Table II). Moreover, no specific mesh refinement has been needed (Figure 4).

5.2 A more complicated example: micro-converter inductance

The second test case is an inductance of micro-converter. It is composed of a complex-shaped conductor and of two ferrite parts (Figure 5). In our study, the conductor is fed by a voltage source (1V, 10 kHz) and the ferrite is considered to be linear with a permeability of 1,000. Values of currents and the magnetic field

Table I.
Currents values in the passive loop (A)

<i>FEM method</i>			
Number of volume element	230,000	570,000	1,000,000
Current values	$-36.25 + 6.00i$	$-32.47 + 7.94i$	$-32.61 + 7.87i$
<i>FEM/PEEC method</i>			
Number of volume element	60,000	90,000	120,000
Current values	$-32.60 + 8.38i$	$-32.60 + 8.35i$	$-32.50 + 8.34i$
<i>MMM/PEEC method</i>			
Number of volume element	32	126	392
Current values	$-35.90 + 8.89i$	$-32.78 + 8.28i$	$-32.54 + 8.26i$

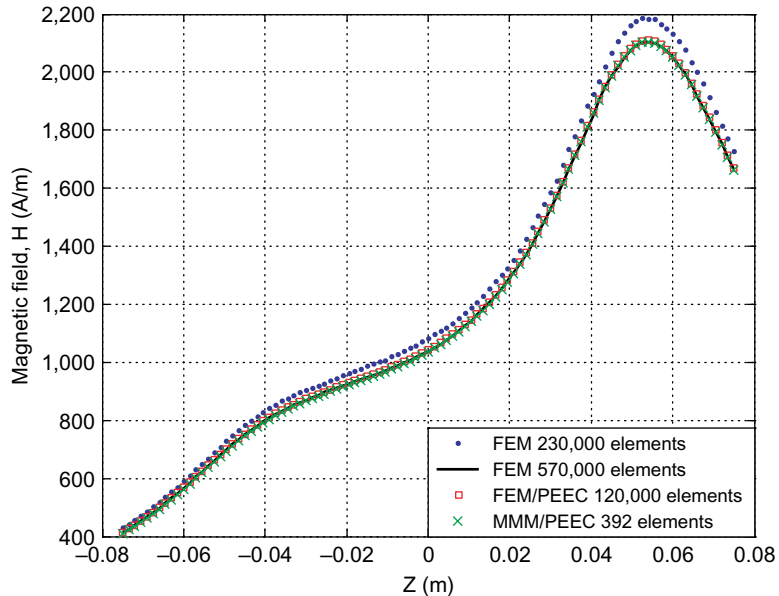

Figure 3.
Magnetic field on line 1 calculated by three methods

(calculated on the same line 2 in Figure 5) are still compared. Let us notice that this kind of devices is very difficult to model with a simple FEM approach regarding the complex shape of conductors.

Both MMM/PEEC and FEM/PEEC couplings converge to quite close current values (Figure 6). Figures 7 and 8 also show that the outside computed magnetic fields are very close for all methods. If we consider that FEM/PEEC coupling as our reference, the MMM/PEEC leads to an error of 0.1 percent for the real part of the current and of 3.8 percent for the imaginary one. This small inaccuracy is mainly due to the small distance between conductors and the magnetic material, leading to important variation of magnetization in the neighborhood of currents. Therefore, the current value of MMM/PEEC method will be more accurate if the mesh of magnetic material is refined. Let us notice that the problem fully dense matrix and the memory need could be solved with the well-known fast multipole method (FMM) (Buchau *et al.*, 2008; Of *et al.*, 2009).

6. Conclusion

In this paper, we have presented a coupling between PEEC and MMM. This coupling enables the introduction of linear magnetic materials in PEEC 3D methodology. Moreover, the used of an integral volume equation will enable the future integration

Method	CPU time (s)	Memory space (MB)
MMM/PEEC (392 volume elements)	320	11
FEM/PEEC (120,000 volume elements)	3,750	112
FEM (570,000 volume elements)	41,560	2,538

Table II.
Memory space and CPU time for convergence results (using computer Intel® CPU 5160 @ 3 GHz; 16 GB RAM)

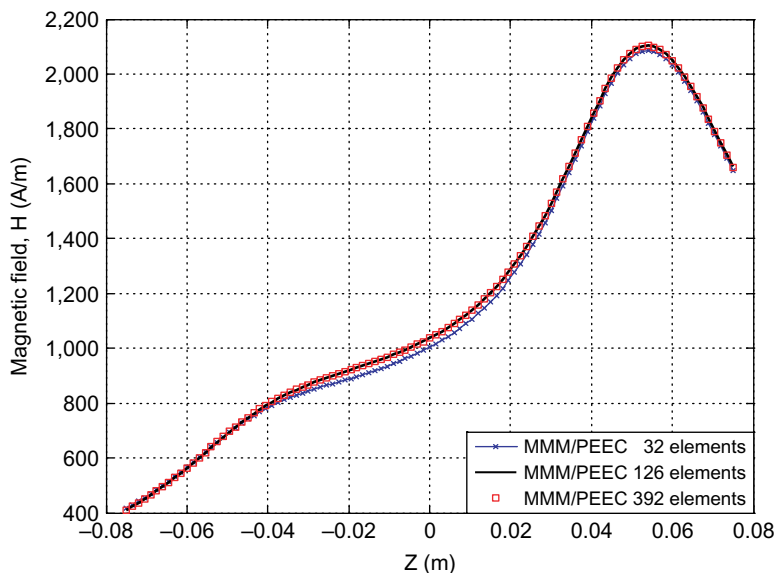

Figure 4.
Magnetic field on line 1 calculated by MMM/PEEC method

Figure 5.
Micro-converter
inductance

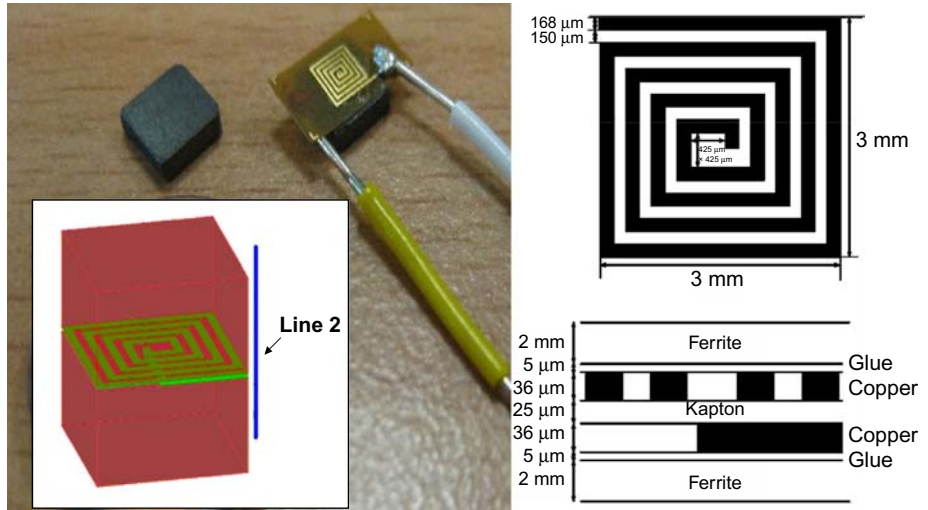
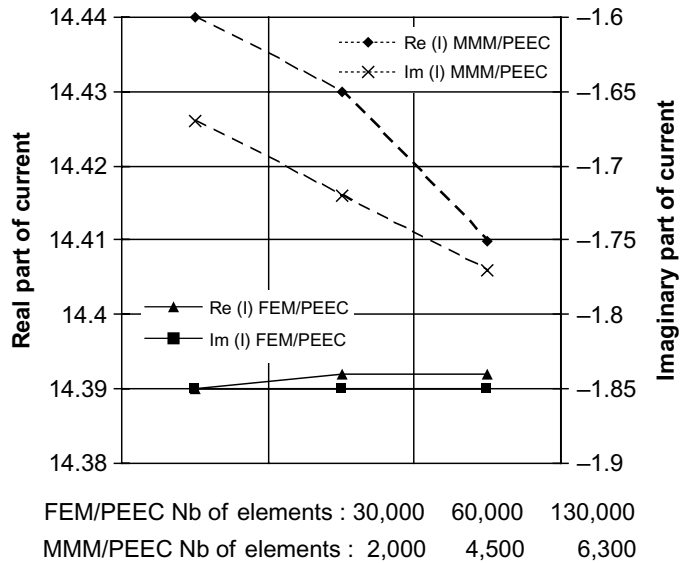

Figure 6.
Current convergence



of non-linear material laws. Through a simple example, we have validated this formulation. The result has shown that the coupling can be very fast, accurate with respect to a pure FEM method or FEM/PEEC coupling on the simple geometry. Through the modeling of a micro-converter inductance, we have demonstrated that the MMM/PEEC coupling is capable of modeling conductors with complex shape and magnetic materials with simple geometry.

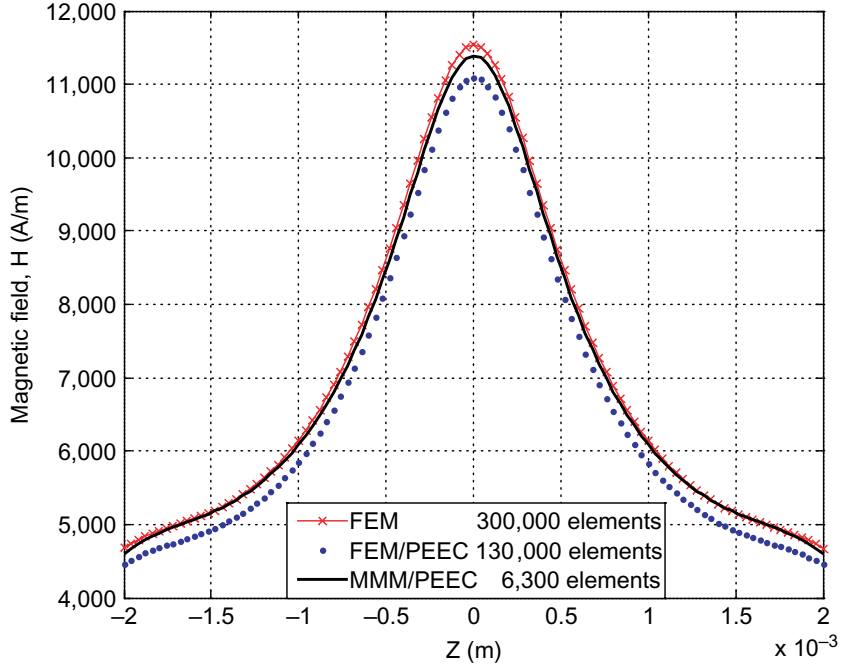

Figure 7.
Magnetic field on line 2
calculated by
three methods

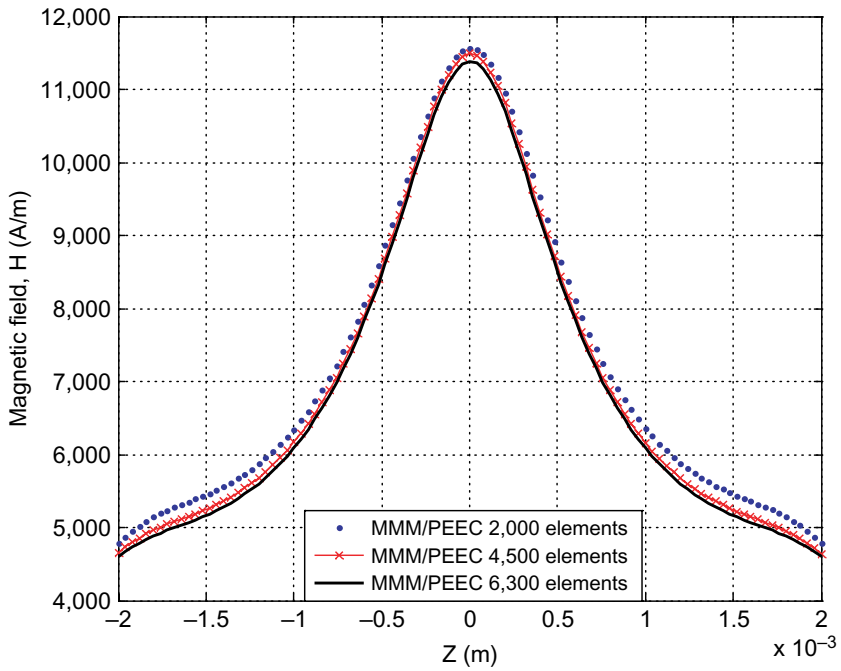

Figure 8.
Magnetic field on line 2
calculated by
MMM/PEEC method

References

- Antonini, G., Sabatini, M. and Miscione, G. (2006), "PEEC modeling of linear magnetic materials", *IEEE International Symposium on Electromagnetic Compatibility 2006, EMC 2006*, Vol. 1, pp. 93-8.
- Buchau, A., Tsafak, S., Hafla, W. and Rucker, W. (2008), "Parallelization of a fast multipole boundary element method with cluster OpenMP", *IEEE Transactions on Magnetics*, Vol. 44 No. 6, pp. 1338-41.
- Chadebec, O., Coulomb, J.-L. and Janet, F. (2006), "A review of magnetostatic moment method", *IEEE Transactions on Magnetics*, Vol. 42 No. 4, pp. 515-20.
- Clavel, E., Roudet, J. and Foggia, A. (2002), "Electrical modeling of transformer connecting bars", *IEEE Transactions on Magnetics*, Vol. 38 No. 2, pp. 1378-82.
- Elleaume, P., Chubart, O. and Chavanne, J. (1997), "Computing 3D magnetic fields from insertion devices", *Particle Accelerator Conference*, Vol. 3, pp. 3509-11.
- Harrington, R.F. (1968), *Field Computation by Moment Methods*, Macmillan, New York, NY.
- Keradec, J.-P., Clavel, E., Gonnet, J.-P. and Mazaauric, V. (2005), "Introducing linear magnetic materials in PEEC simulations. Principles, academic and industrial applications", *Industry Applications Conference, 2005. Fortieth IAS Annual Meeting. Conference Record of the 2005*, Vol. 3, pp. 2236-40.
- Kovacevic, I.F., Muesing, A. and Kolar, J.W. (2011), "An extension of PEEC method for magnetic materials modeling in frequency domain", *IEEE Transactions on Magnetics*, Vol. 47 No. 5, pp. 910-13.
- Le Duc, T., Chadebec, O., Guichon, J.-M., Meunier, G., Lembeye, Y. and Delinchant, B. (2009), "Numerical experimentations on the coupling between PEEC and volume integral method", *Proceedings of COMPUMAG, Florianopolis, Brazil*.
- Le Floch, Y., Meunier, G., Guerin, C., Labie, P., Brunotte, X. and Boudaud, D. (2003), "Coupled problem computation of 3-D multiply connected magnetic circuits and electrical circuits", *IEEE Transactions on Magnetics*, Vol. 39 No. 3, pp. 1725-8.
- Mokhtari, L., Delinchant, B., Chevalier, T. and Coulomb, J.-L. (2010), "Comparing weak and strong PEEC-MoM coupling", *IEEE Transactions on Magnetics*, Vol. 46 No. 8, pp. 2775-8.
- Of, G., Kaltenbacher, M. and Steinbach, O. (2009), "Fast multipole boundary element method for electrostatic field computations", *COMPEL: The International Journal for Computation and Mathematics in Electrical and Electronic Engineering*, Vol. 28 No. 2, pp. 304-19.
- Roudet, J., Clavel, E., Guichon, J.-M. and Schanen, J.-L. (2004), "Modélisation PEEC des connexions dans les convertisseurs de puissance", *Techniques de l'ingénieur*, Vol. D3071, p. 1 (in French).
- Ruehli, A.E. (1974), "Equivalent circuit models for three dimensional multiconductor systems", *IEEE Transaction on Microwave Theory and Techniques*, Vol. 22 No. 3, pp. 216-21.
- Takahashi, Y., Matsumoto, C. and Wakao, S. (2007), "Large-scale and fast nonlinear magnetostatic field analysis by the magnetic moment method with the adaptive cross approximation", *IEEE Transactions on Magnetics*, Vol. 43 No. 4, pp. 1277-80.
- Tran, T.-S., Meunier, G., Labie, P. and Aime, J. (2010), "Comparison of FEM-PEEC coupled method and finite-element method", *IEEE Transaction on Magnetics*, Vol. 46 No. 4, pp. 996-9.

-
- Tran, T.-S., Meunier, G., Labie, P., Le Floch, Y., Guichon, J.-M. and Roudet, J. (2008), "FEM-PEEC coupled method for modeling solid conductors in the presence of ferromagnetic material", *COMPEL: The International Journal for Computation and Mathematics in Electrical and Electronic Engineering*, Vol. 27 No. 4, pp. 904-10.
- Vassent, E., Meunier, G. and Sabonnadiere, J.C. (1989), "Simulation of induction machine operation using complex magnetodynamic finite elements", *IEEE Transaction on Magnetics*, Vol. 25 No. 4, pp. 3064-6.
- Wollenberg, G. and Kochetov, S.V. (2011), "PEEC method: circuit models for electromagnetic field problems", *COMPEL: The International Journal for Computation and Mathematics in Electrical and Electronic Engineering*, Vol. 30 No. 4, pp. 1283-95.