



**HAL**  
open science

# Fault Tolerant Control of a Seven-phase Drive by Degrees of Freedom Adaptation

Xavier Kestelyn, Yvan Crevits, Eric Semail

► **To cite this version:**

Xavier Kestelyn, Yvan Crevits, Eric Semail. Fault Tolerant Control of a Seven-phase Drive by Degrees of Freedom Adaptation. ICIT'10, IEEE International Conference on Industrial Technology, Mar 2010, Chile. pp.1513-1518, <10.1109/ICIT.2010.5472476>. <hal-00819006>

**HAL Id: hal-00819006**

**<https://hal.science/hal-00819006v1>**

Submitted on 29 Apr 2013

HAL is a multi-disciplinary open access archive for the deposit and dissemination of scientific research documents, whether they are published or not. The documents may come from teaching and research institutions in France or abroad, or from public or private research centers.

L'archive ouverte pluridisciplinaire HAL, est destinée au dépôt et à la diffusion de documents scientifiques de niveau recherche, publiés ou non, émanant des établissements d'enseignement et de recherche français ou étrangers, des laboratoires publics ou privés.



HAL Authorization

# Fault Tolerant Control of a Seven-phase Drive by Degrees of Freedom Adaptation

Xavier KESTELYN, Yvan CREVITS and Eric SEMAIL  
Arts et Métiers ParisTech L2EP. Bd Louis XIV 59046 Lille - France  
Xavier.Kestelyn@ensam.eu

**Abstract-** This paper proposes a simple way to control multi-phase drives in open-phase conditions. Contrary to existing methods, current references are not recomputed and the control scheme is kept the same to run in open-circuited phase condition. In order to work in fault-conditions, the number of degrees of freedom of the control scheme is adapted to the number of degrees of freedom of the drive. Since a particular attention has to be dedicated to the structure and controller tuning, harmonic content of induced perturbations in fault mode is exhibited. Simulation and experimental results are presented to show the effectiveness and the limitations of the proposed method.

## I. INTRODUCTION

Many applications require fault-tolerant drives in order to ensure continuing security or productivity. Among existing solutions, multi-phase drives offer, due to their inherent additional degrees of freedom, an attractive alternative [1]. For example, a star-coupled  $n$ -phase machine can run with up to  $(n-3)$  phases in fault-condition with no additional devices.

If many types of faults can occur, open-circuit faults are the most commonly found. In that case, currents in the healthy phases must be modified in order to reduce the impact of the fault on the torque quality. Several post-fault strategies may be applied. In most of the cases the objective is to keep a constant torque even with open-circuited phases. The limiting factor is then the thermal state of the machine, which is directly related to the level of the Joule losses.

Two major sets of methods can be distinguished.

In the first method set [2]-[6], new current references are calculated off line (on line in [2]), considering different fault mode cases, in order to maintain a constant torque. Although these methods seem simple and direct, several drawbacks have to be highlighted. First, a new set of current references has to be computed and stored in tables for each case of fault-mode. For machines with a high number of phases, it leads to a high number of combinations and thereby to large capacity storage systems. Finally, the varying current waveforms impose the use of large bandwidth controllers such as hysteresis controllers, which is prohibited for high power systems.

In the second method set [7], for each case of fault-mode, a new transformation is calculated in order to obtain new  $dq$  rotating reference frames. Although current references are kept constant whatever the functioning mode, a large number of transformations has to be stored in memory. Moreover, in order

to be able to switch without discontinuity between several models, it is necessary to take care of the initialization of the new state variables when a fault occurs.

This paper proposes a simple way to control a multi-phase drive in open-circuited phase mode. Under the condition that the drive is specially design for fault-tolerant operations, this method makes possible to control the drive in normal as in open-circuited phase mode, keeping the same control scheme and the same current references in chosen  $dq$  frames. The basics of the method consist in adapting the number of degrees of freedom of the control scheme to the number of degrees of freedom of the drive. The quality of the torque waveform depends then directly on the functioning mode and the current controller's bandwidth.

Section II presents the seven-phase drive which has been specifically designed for fault-tolerant applications. A unique model of the drive whatever the functioning mode is presented. Finally, the source of induced harmonic perturbations in open-circuited phase condition is exhibited.

Section III details how the control scheme is adapted in order to keep a constant torque in fault-mode. Based on the harmonic content of the induced perturbations in fault-mode, the tuning of PI current controllers is discussed.

Finally, section IV shows simulation and experimental results in order to prove the effectiveness and to insist on the limitations of the proposed method.

## II. UNIQUE MODELLING OF A MULTI-PHASE DRIVE IN NORMAL AND OPEN-CIRCUITED PHASE CONDITIONS

### A. Unique Modelling of the Drive viable in Normal Mode as in open-circuited phase mode

The proposed drive is a star-coupled six-pole seven-phase NN TORUS machine with two external rotors which has been specially designed for fault-condition operations [8],[9]. The stator of the machine, with Gramme-ring windings, is soft magnetic composite made with 42 slots. The rotor permanent magnets have a specific shape in order to suppress the fifth harmonic of back electromotive-forces.

To model open-circuited phases with keeping the same model for the machine, an additional variable resistor is added in series with the machine phases. This way of modelling makes possible to keep a unique model of the drive whatever the functioning mode (normal or open-circuited phases) [10].

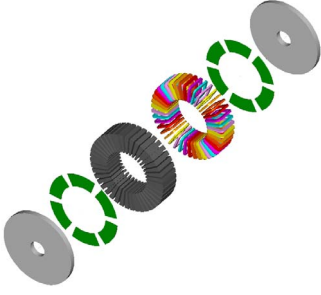

Fig. 1 Exploded view of the considered axial flux seven-phase machine.

Under classical assumptions and according to [10], the unique model of a seven-phase drive can be described by equations (1), (2) and (3):

$$\vec{v} = \mathfrak{R}_c(\vec{i}) + R\vec{i} + A\left(\frac{d\vec{i}}{dt}\right) + \vec{e} \quad (1)$$

$$\text{mat}(\mathfrak{R}_c, ABC) = \text{diag}(R_{cA} \ R_{cB} \ \dots \ R_{cG}) \quad (2)$$

$$T \cdot \Omega = \vec{e} \cdot \vec{i} \quad (3)$$

with:

- $\vec{v}$ ,  $\vec{i}$  and  $\vec{e}$  the seven-dimensional stator voltage, current and EMF vectors respectively.
- $\mathfrak{R}_c$  a linear relation described by a 7-by-7 diagonal connexion resistance matrix.  $R_{ck} = 0$  if phase  $k$  is connected to the supply or  $R_{ck} \rightarrow \infty$  if phase  $k$  is open-circuited.
- $R$ , stator resistance and  $A$ , a linear relation described by a 7-by-7 stator inductance matrix.
- $T$ , electromagnetic torque and  $\Omega$ , mechanical speed.

### B. Chosen Torque Control Structure

The machine is controlled using a multi-reference frame approach [11],[12]. Each 7-dimensional vector is split in three 2-dimensional vectors (one dimension is ignored due to the star-coupling). Each 2-dimensional vector belongs to a two-dimensional eigenspace of the initial 7-dimensional space. Since all eigenspaces are orthogonal, the initial 7-phase star-coupled machine can be considered as equivalent to a set of three fictitious two-phase machines (called  $M1$ ,  $M2$  and  $M3$ ). These fictitious machines are magnetically independent and mechanically coupled on the same mechanical shaft.

Two-dimensional vectors' coordinates of each fictitious machine are obtained with a Concordia-type orthonormal transformation [12],[13]. Variables of a fictitious machine are called  $(\alpha, \beta)$  components.

Finally, since the considered machine in this paper has been specifically designed for fault operation, back-electromotive forces are mainly composed of harmonic one and three. The electromotive force of  $M2$  machine is ideally equal to zero. In order to have constant current references in steady state, a rotation operator is applied on  $(\alpha, \beta)$  components of machines  $M1$  and  $M3$ . The overall control is then achieved in multiple  $dq$  rotating reference frames. Fig.2 shows the structure of the chosen torque control.

### C. Analysis of the connection resistance matrix in $(\alpha\beta)$ and $(dq)$ reference frames

In order to evaluate the effects of open-circuited phases over  $\alpha\beta$  components, the connection resistance matrix is expressed in  $(\alpha\beta)$  reference frames by (4) with  $[C7]$  expressed by (5).

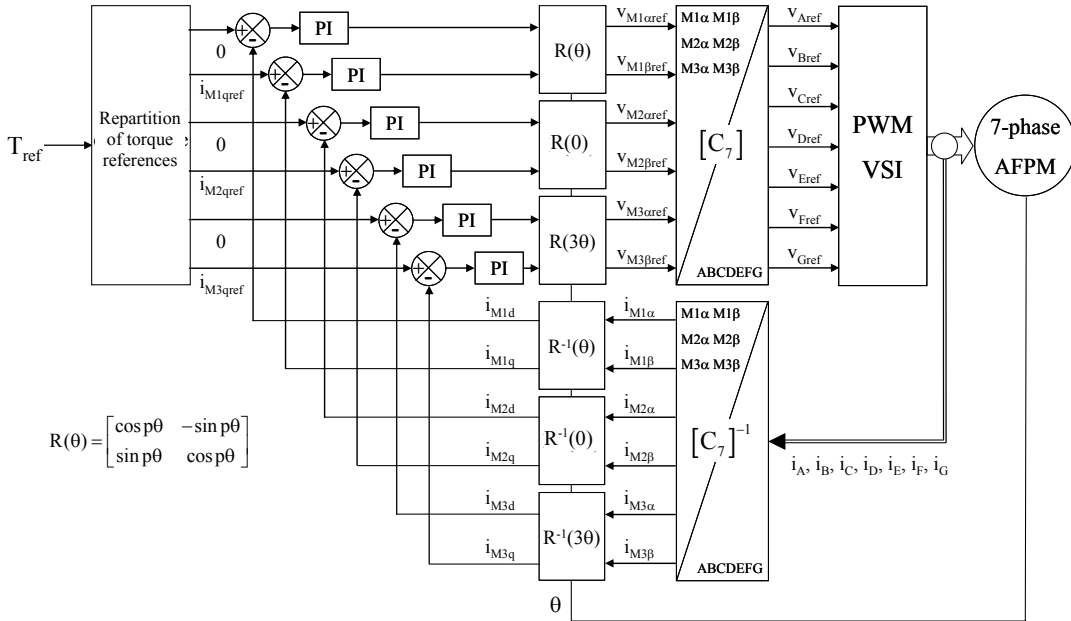

Fig. 2. Structure of the torque control

$$\text{mat}(\mathfrak{R}_c, \alpha\beta) = [C_7]^{-1} \text{mat}(\mathfrak{R}_c, ABC) [C_7] \quad (4)$$

$$[C_7] = \sqrt{\frac{2}{7}} \begin{bmatrix} 1 & 0 & 1 & 0 & 1 & 0 & \frac{1}{\sqrt{2}} \\ \cos \frac{2\pi}{7} & \sin \frac{2\pi}{7} & \cos \frac{4\pi}{7} & \sin \frac{4\pi}{7} & \cos \frac{6\pi}{7} & \sin \frac{6\pi}{7} & \frac{1}{\sqrt{2}} \\ \cos \frac{4\pi}{7} & \sin \frac{4\pi}{7} & \cos \frac{8\pi}{7} & \sin \frac{8\pi}{7} & \cos \frac{12\pi}{7} & \sin \frac{12\pi}{7} & \frac{1}{\sqrt{2}} \\ \cos \frac{6\pi}{7} & \sin \frac{6\pi}{7} & \cos \frac{12\pi}{7} & \sin \frac{12\pi}{7} & \cos \frac{18\pi}{7} & \sin \frac{18\pi}{7} & \frac{1}{\sqrt{2}} \\ \cos \frac{8\pi}{7} & \sin \frac{8\pi}{7} & \cos \frac{16\pi}{7} & \sin \frac{16\pi}{7} & \cos \frac{24\pi}{7} & \sin \frac{24\pi}{7} & \frac{1}{\sqrt{2}} \\ \cos \frac{10\pi}{7} & \sin \frac{10\pi}{7} & \cos \frac{20\pi}{7} & \sin \frac{20\pi}{7} & \cos \frac{30\pi}{7} & \sin \frac{30\pi}{7} & \frac{1}{\sqrt{2}} \\ \cos \frac{12\pi}{7} & \sin \frac{12\pi}{7} & \cos \frac{24\pi}{7} & \sin \frac{24\pi}{7} & \cos \frac{36\pi}{7} & \sin \frac{36\pi}{7} & \frac{1}{\sqrt{2}} \end{bmatrix} \quad (5)$$

Contrary to  $\text{mat}(\mathfrak{R}_c, ABC)$ , which is diagonal,  $\text{mat}(\mathfrak{R}_c, \alpha\beta)$  is a full matrix whose elements are linear combinations of connexion resistances  $R_{cA}$  to  $R_{cG}$ . Then, the opening of phases has an impact over each fictitious machine.

The expression of the connexion matrix in  $(dq)$  reference frames is given by (6) with  $\text{Rot}(\theta)$  expressed by (7).

$$\text{mat}(\mathfrak{R}_c, dq) = [\text{Rot}(-\theta)] \text{mat}(\mathfrak{R}_c, \alpha\beta) [\text{Rot}(\theta)] \quad (6)$$

$$\text{Rot}(\theta) = \begin{bmatrix} \cos \theta & -\sin \theta & 0 & 0 & 0 & 0 & 0 \\ \sin \theta & \cos \theta & 0 & 0 & 0 & 0 & 0 \\ 0 & 0 & 1 & 0 & 0 & 0 & 0 \\ 0 & 0 & 0 & 1 & 0 & 0 & 0 \\ 0 & 0 & 0 & 0 & \cos 3\theta & -\sin 3\theta & 0 \\ 0 & 0 & 0 & 0 & \sin 3\theta & \cos 3\theta & 0 \\ 0 & 0 & 0 & 0 & 0 & 0 & 1 \end{bmatrix} \quad (7)$$

$\text{mat}(\mathfrak{R}_c, dq)$  is a full matrix and its elements are linear combinations of connexion resistances  $R_{cA}$  to  $R_{cG}$  and trigonometric functions of  $\theta, 2\theta, 3\theta, 4\theta$  and  $6\theta$ . It can be then concluded that in open-circuited phase mode,  $dq$  reference voltages will be disturbed by harmonic components.

### III. ADAPTATION OF THE TORQUE CONTROL SCHEME IN OPEN-CIRCUITED PHASE MODE

#### A. Adaptation of the number of degrees of freedom of the current control

The machine being star-coupled, current vector  $\vec{i}$  is a 6-dimensional vector (7-1=6). When some phases are open-circuited, the corresponding currents are physically set to zero. Consequently, the dimension of the 6-dimensional current vector is reduced.

A first solution consists in recalculating new current references in order to adapt the dimension of the current reference vector to the number of degrees of freedom of the drive. The new references are chosen in a way that torque is constant and Joules losses are minimized.

Another solution consists in finding new orthogonal subspaces within the machine can be easily controlled.

In this paper, we propose to keep the current control used in normal mode and to adapt its number of degrees of freedom to the number of degrees of freedom of the drive. Since the current control is made in  $(dq)$  rotating reference frames, if  $m$  phases are open-circuited,  $m$  currents in  $dq$  frames are no longer controlled, i.e. some fictitious machines are no longer controlled.

#### B. Choice of the fictitious machines not controlled in case of open-circuited phases

If  $m$  phases are open-circuited, only  $(6-m)$   $dq$  currents can be controlled. The expression of the  $m$   $dq$  currents that are not controlled are imposed by the  $(6-m)$  controlled currents in accordance with physical constraint of nullity of  $m$  real currents. Their amplitudes are not equal to zero and, by combination with non-zero emf, a pulsating torque can appear.

The seven-phase machine, which has been specially designed for fault-operation, has essentially emf composed of harmonics one and three. Since it has been demonstrated that each fictitious machine is associated with a set of emf harmonics [9], for the considered machine, only machines  $M1$  and  $M3$  are able to produce torque. Whatever currents in  $M2$  machine, there are then only losses and no associated torque since emfs of  $M2$  machine are equal to zero when only the first and the third harmonics are present in emfs of the real machine.

The chosen strategy is then the following:

- In normal mode, the six  $dq$  currents are controlled, i.e. the three fictitious machines. Currents of machine  $M2$ , which do not possess emf, are imposed to zero in order to reduce Joules losses.
- If two phases are open-circuited, currents of machine  $M2$  are no longer controlled.
- If one phase is open-circuited, one another phase is open. Indeed, when only one phase is open, controlling only one current of a fictitious machine leads to disturbances with a large spectrum. The other phase to be opened is chosen in order to balance the temperature on the machine. Ideally the pulsating torques are minimized if the second opened phase is located at  $90^\circ$  from the original [14]. In case of a seven-phase machine it is then preferable to choose a phase at  $4\pi/7$  ( $102,9^\circ$ ) from the original open-circuit phase.

The interest of the chosen strategy is essentially that it is simple and gives good results under constraints of design for the machine.

#### C. Current controller requirements to reject disturbances in fault-mode

In normal mode and steady state, current references and voltage disturbances are constant. PI controllers are then sufficient.

In fault mode, even if current references are kept constant, variable voltage disturbances appear due to the resistance connection matrix whose elements are variable.

In order to evaluate the current controller requirements in terms of disturbance rejection, the following steps have to be followed.

The first step consists in calculating the  $dq$  components of the currents in machine  $M2$ . These current components are found with solving the 7 unknowns / 7 equations system presented in (8), where:

- $i_{M2d}, i_{M2q}$  are the unknowns, to be found
- $i_{M1d}, i_{M1q}, i_{M3d}, i_{M3q}$  are kept constant to maintain a constant torque
- $i_{Mh}=0$  due to the star-coupling
- two phase currents are set to zero due to the two open-circuited phases

$$\begin{pmatrix} i_{M1d} \\ i_{M1q} \\ i_{M2d} \\ i_{M2q} \\ i_{M3d} \\ i_{M3q} \\ i_{Mh} \end{pmatrix} = [Rot(-\theta)][C_7]^{-1} \begin{pmatrix} i_A \\ i_B \\ i_C \\ i_D \\ i_E \\ i_F \\ i_G \end{pmatrix} \quad (8)$$

The second step consists in evaluating the voltage disturbances  $\vec{v}_{dis} = \mathfrak{R}_c(\vec{i})$  (see (1)). This evaluation is made by solving (9).

$$\begin{pmatrix} v_{dis\_1d} \\ v_{dis\_1q} \\ v_{dis\_2d} \\ v_{dis\_2q} \\ v_{dis\_3d} \\ v_{dis\_3q} \\ v_{dis\_h} \end{pmatrix} = mat(\mathfrak{R}_c, dq) \begin{pmatrix} i_{M1d} \\ i_{M1q} \\ i_{M2d} \\ i_{M2q} \\ i_{M3d} \\ i_{M3q} \\ i_{Mh} \end{pmatrix} \quad (9)$$

The last step consists in calculating the PI parameters in order to be able to reject the voltage disturbances  $v_{dis}$ . An efficient way to tune PI controllers with good disturbance rejection abilities is the Symmetrical Optimum [15]. Using this method, each PI controller is tuned using criterion (10):

$$PI_{dq}(s) = K_p \frac{1 + \tau_i s}{\tau_i s} \quad (10)$$

$$\tau_i = 4\tau_{low} \quad K_p = \frac{1}{2} \frac{L_j}{\tau_{low}}$$

Time constant  $\tau_{low}$  corresponds to the sum of delays coming essentially from the Pulse Width Modulation and the sampling period. Inductance  $L_j$  depends on the controlled fictitious machine.

#### IV. SIMULATION AND EXPERIMENTAL VALIDATION OF THE PROPOSED METHOD

##### A. Presentation of the experimental setup

The drive is supplied by a seven-leg voltage source inverter controlled with Pulse Width Modulation. The DC bus voltage is set to 200V. Fig.3 shows a snapshot of the experimental setup.

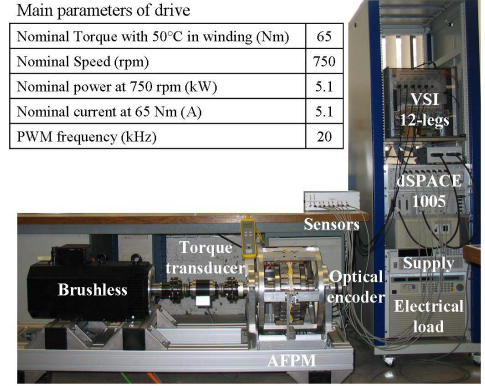

Fig. 3. Experimental setup

##### B. Simulation and experimental results

The mechanical load is composed of a DC brushless machine whose speed is controlled at 20 rad/s.

###### Normal Mode (NM)

The current references are set to the following values:

$$i_{M1d}=0, i_{M1q}=-5A, i_{M2d}=0, i_{M2q}=0, i_{M3d}=0, i_{M3q}=-2A.$$

As shown in Fig.4, each phase current is composed of harmonics 1 and 3. With constant  $dq$  current references and consequently constant  $dq$  voltage references (see Fig.8), the torque, produced by machines  $M1$  and  $M3$  is almost constant (see Fig.7).

###### Fault Mode (FM)

For example when phases  $C$  and  $D$  are open-circuited,  $dq$  current references in machines  $M1$  and  $M3$  are kept the same as in normal mode. As a consequence and according to (8), currents in machine  $M2$  are not null and are composed of harmonics 1 and 3 (see Fig.6 and Fig.10). Finally, it has to be noticed that simulation and experimental results are very closed, which proved that the proposed way of modelling leads to a very good accuracy (see Fig.6 and Fig.9 for comparison).

According to (9), reference voltages are no longer constant and possess harmonics 2, 4 and 6. Voltage references in fault mode are shown in Fig.8 and their relative harmonic contents are exhibited in Fig.11.

Since  $dq$  currents in machines  $M1$  and  $M3$  are almost kept constant, as shown in Fig.7 the torque has few ripples. It has to be mentioned that the torque ripple amplitudes are directly linked to the current controllers' ability to reject the voltage disturbances, i.e. its bandwidth.

With PI controller by the Symmetrical Optimum method, the bandwidth is about  $1/(2\tau_{low})$ . As a consequence, if we want to eliminate the reference voltage harmonics up to the sixth (see fig. 11), the proposed method can be used as far as

$6p\Omega < 1/(2\tau_{low})$ . In our case, the machine has three pole pairs ( $p=3$ ) and time constant  $\tau_{low}$  is set to  $0.8\text{ ms}$  which leads to a maximum mechanical speed of  $\Omega=34.7\text{ rad/s}$ .

Finally, none zero currents in machine  $M2$  have no influence over the torque quality since the machine has been designed in order not to have fifth harmonic of emfs.

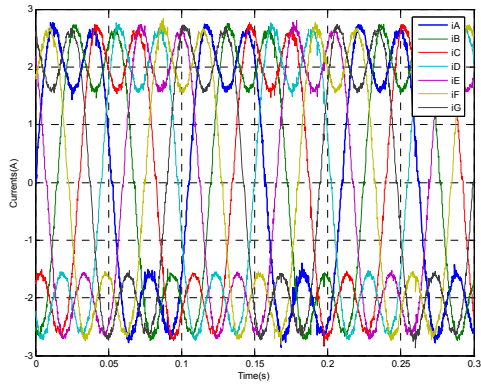

Fig. 4. Seven phase currents in Normal Mode (NM) (Experimental Results)

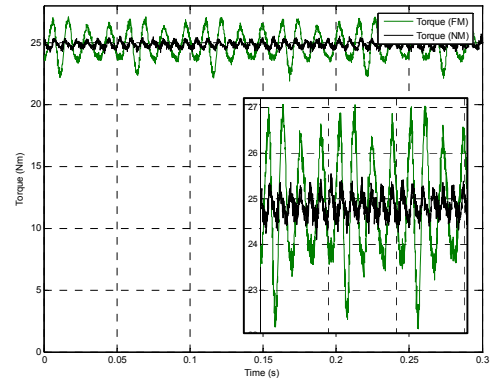

Fig. 7. Electromagnetic torques in NM and FM (Experimental Results)

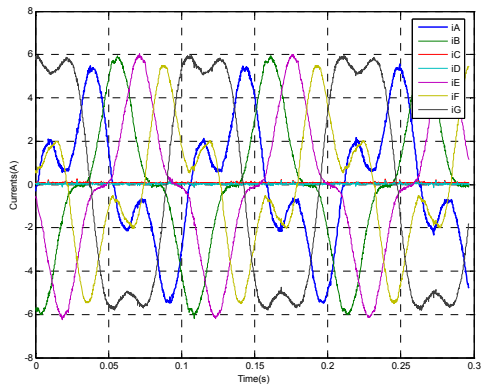

Fig. 5. Seven phase currents in Fault Mode (FM) (Experimental Results)

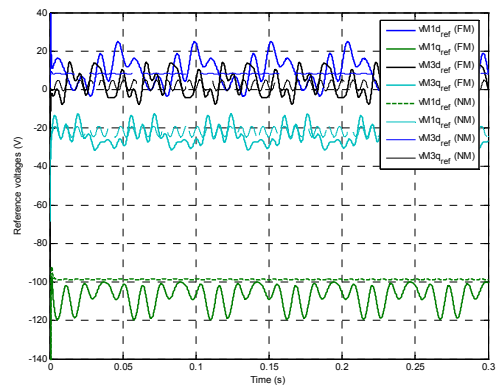

Fig. 8. dq reference voltages in NM and FM (Simulation Results)

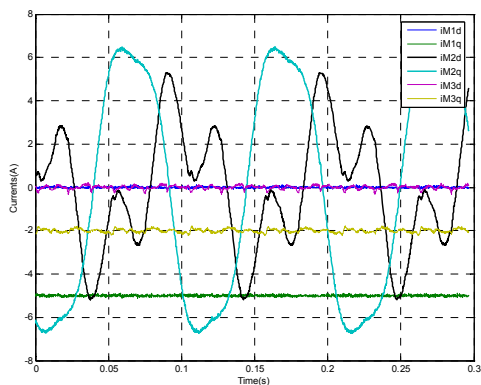

Fig. 6. dq currents in Fault Mode (Experimental Results)

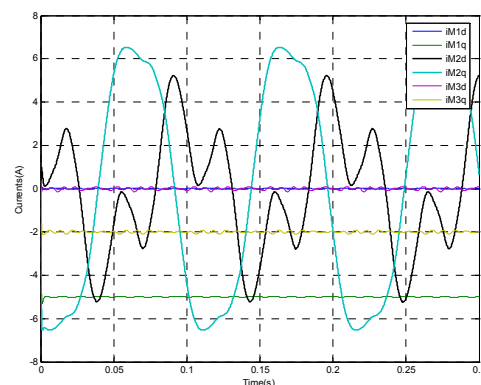

Fig. 9. dq currents in Fault Mode (Simulation Results)

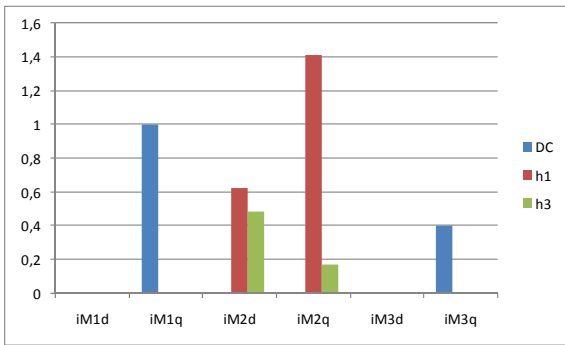

Fig. 10. Relative harmonic content of dq currents in machines M1, M2 and M3 in FM

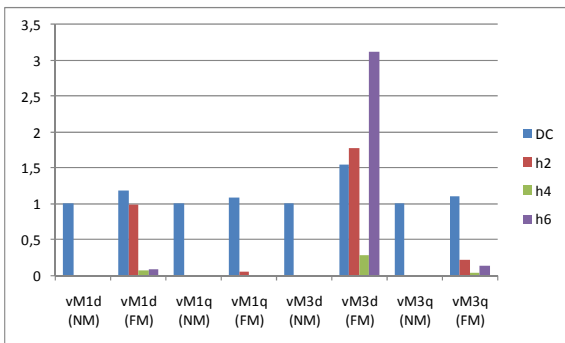

Fig. 11. Relative harmonic content of dq reference voltages in machines M1 and M3 in NM and FM

## CONCLUSION

This paper shows a simple way to control multi-phase machines with open-circuited phases. Under the condition of a machine specifically designed and the adaptation of the number of degrees of freedom of the control scheme, it is possible to keep a constant torque in fault mode with keeping the same multiple  $dq$  reference frames control structure as in normal mode. Using connection resistances, a unique model of the drive, viable in normal as in fault mode, is developed. An analysis of the voltage disturbances appearing in fault-mode makes possible to define the necessary performances of the current controllers. Finally, simulation and experimental results show the simplicity and the effectiveness of the proposed unique model of the drive and the method to control the torque in fault-mode.

## REFERENCES

- [1] E. Levi, "Multiphase Electric Machines for Variable Speed", *IEEE Trans. on Industrial Electronics*, vol. 55, no. 5, May 2008
- [2] X. Kestelyn, E. Semail, Y. Crévits, "Generation of On-line Optimal Current References for Multi-phase Permanent Magnet Machines with Open-circuited Phases" *IEEE International Electric Machines & Drives Conference*, vol.2, pp.1131-1135, May 2009.
- [3] R. Fu, T.A. Lipo, "Disturbance-free operation of a multiphase current-regulated motor drive with an opened phase," *IEEE Trans. on Industry Applications*, vol.30, no.5, pp.1267-1274, Sep/Oct 1994
- [4] J. Wang, K. Atallah, D. Howe, "Optimal torque control of fault-tolerant permanent magnet brushless machines", *IEEE Trans. on Magnetics*, vol. 39, issue: 5, pp. 2962-2964, Sept. 2003.
- [5] N. Bianchi, S. Bolognani, M.D. Pre, "Strategies for the Fault-Tolerant Current Control of a Five-Phase Permanent-Magnet Motor", *IEEE Trans. on Industry Applications*, vol.43, no.4, pp.960-970, July-aug. 2007
- [6] S. Dwari, L. Parsa, "An Optimal Control Technique for Multiphase PM Machines Under Open-Circuit Faults," *IEEE Trans. on Industrial Electronics*, vol.55, no.5, pp.1988-1995, May 2008.
- [7] H. M. Ryu, J. H. Kim and S. K. Sul, "Synchronous-Frame Current Control of Multiphase Synchronous Motor Under Asymmetric Fault Condition due to Open Phases", *IEEE Trans. on Industry Applications*, vol. 42, n°4, July/August 2006, pp.1062-1070.
- [8] F. Locment, E. Semail, F. Piriou, "Design and Study of a Multi-phase Axial-flux machine", *IEEE Trans. on Magnetics*, vol. 42, no. 4, pp. 1427-1430, April 2006
- [9] E. Semail, X. Kestelyn, F. Locment, "Fault Tolerant Multiphase Electrical Drives: The Impact of Design", *EPJ AP (European Physical Journal-Applied Physics)*, Vol 43, n°2, August 2008
- [10] X. Kestelyn, F. Locment, Y. Crévits, E. Semail, "Easy-to-Implement Integral Numerical Simulation of Multi-phase Drives under Fault Supply Condition," *Proc. of IEMDC '07, IEEE International Electric Machines & Drives Conference*, vol.2, pp.1131-1135, May 2007.
- [11] H. M. Ryu, J. W. Kim and S. K. Sul, "Synchronous Frame Current Control of Multi-Phase Synchronous Motor, Part I. Modeling and Current Control Based on Multiple d-q Spaces Concept Under Balanced Condition", *Proc. of IEEE-IAS'04*, vol. 1, pp. 56-63, Seattle (USA), Oct. 2004.
- [12] E. Semail, X. Kestelyn and A. Bouscayrol, "Right Harmonic Spectrum for the back-electromotive force of a n-phase synchronous motor", *Proc. of IEEE-IAS'04*, Seattle (USA), Oct. 2004, Vol. 1, pp.71-78.
- [13] F. Locment, E. Semail, X. Kestelyn, "Vectorial Approach-Based Control of a Seven-Phase Axial Flux Machine Designed for Fault Operation," *IEEE Trans. on Industrial Electronics*, vol.55, no.10, pp.3682-3691, Oct. 2008
- [14] J. P. Martin, F. Meibody-Tabar and B. Davat, "Multiple-phase Permanent Magnet Synchronous Machine Supplied By VSIs, working under Fault Conditions", *Proc. of IEEE-IAS'00*, Roma (Italy), Oct. 2000, Vol.3, pp. 1710 - 1717.
- [15] S. N. Vukosavić, "Digital Control of Electrical Drives", ch3, Springer Verlag Edition, 2007.