



**HAL**  
open science

## **SMS over LTE: services, architecture and protocols**

Diana-Minodora Ciuraru, Lavinia Hilohi, Antoine Mercier, Xavier Lagrange

► **To cite this version:**

Diana-Minodora Ciuraru, Lavinia Hilohi, Antoine Mercier, Xavier Lagrange. SMS over LTE: services, architecture and protocols. 2013, pp.62. hal-00814264

**HAL Id: hal-00814264**

**<https://hal.science/hal-00814264>**

Submitted on 16 Apr 2013

**HAL** is a multi-disciplinary open access archive for the deposit and dissemination of scientific research documents, whether they are published or not. The documents may come from teaching and research institutions in France or abroad, or from public or private research centers.

L'archive ouverte pluridisciplinaire **HAL**, est destinée au dépôt et à la diffusion de documents scientifiques de niveau recherche, publiés ou non, émanant des établissements d'enseignement et de recherche français ou étrangers, des laboratoires publics ou privés.

Collection des rapports de recherche  
de Télécom Bretagne

**RR-2013-01-SC**

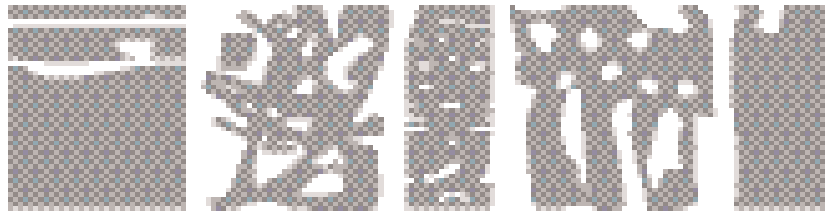

## **SMS over LTC: services, architecture and protocols**

*Diana-Minodora Ciuraru (Télécom Bretagne)*

*Lavinia Hilohi (Télécom Bretagne)*

*Antoine Mercier (Bouygues Télécom)*

*Xavier Lagrange (Télécom Bretagne)*



## Abstract

In recent years, the mobile networks have evolved from a circuit switched approach to a complete packet switched one. The LTE-EPS network (Long Term Evolution – Evolved Packet Core) offers high bandwidth, low latency and improved spectrum efficiency. It provides IP connectivity but does not support valuable legacy services such as the SMS (Short Message Service) in Release 8 to 10.

3GPP is currently specifying two architectures for SMS transmission over LTE in Release 11. The objective of this report is to describe and analyze these architectures with a particular focus on the new gateway called IP-SM-GW (IP Short Message Gateway).

Two complementary scenarios are proposed by 3GPP, depending on the type of LTE device used. When an SMS-capable LTE device communicates to a GSM device, the gateway realizes transport level interworking. However, if the LTE user is unable to create or read SMSs, the IP-SM-GW performs service level interworking.

The implementation of an IP-SM-GW is transparent to the end user, and does not imply any changes in the 2G/3G architecture. This solution is necessary for an operator since it offers his subscribers a higher level of trust and a better acceptance of the implementation of LTE.

**Keywords:** SMS, GSM, LTE, 4G, IMS, IP-SM-GW, interworking scenarios, SIP, protocol stack.

## Résumé

Au cours des dernières années, les réseaux mobiles ont évolué d'une solution à circuit commuté vers une solution complète à commutation des paquets. Le réseau 4G – LTE, offre une bande passante élevée, une latence faible et une excellente efficacité spectrale. Cependant, dans les premières versions des spécifications (Rel 8 à 10), LTE se contente d'offrir un accès IP mais ne propose aucun service à valeur ajoutée comme le SMS.

Pour pallier ce manque, le 3GPP travaille dans la version 10 à la spécification de 2 architectures permettant l'échange de SMS sur un réseau LTE et des protocoles associés. Ce rapport présente les solutions pour la transmission des SMS sur LTE en insistant sur la nouvelle passerelle appelée IP-SM-GW.

Selon le type de dispositif LTE utilisé, deux scénarios sont proposés. Quand un dispositif LTE capable d'envoyer et recevoir des SMS veut communiquer avec un dispositif GSM, la passerelle effectue un interfonctionnement au niveau transport. Toutefois, si l'utilisateur LTE n'est pas capable de créer ou lire des SMS, l'IP-SM-GW exécute un interfonctionnement au niveau service.

L'implémentation d'un IP-SM-GW est transparente pour l'utilisateur final et n'implique pas de changements dans l'architecture 2G/3G. Cette solution est nécessaire pour l'opérateur, car elle offre aux abonnés un plus grand niveau de confiance et une meilleure acceptation de l'implémentation de LTE.

## Table of Contents

Table of Figures	5
1 Context	6
2 Short Message Service	7
2.1 General features	7
2.2 Types of SMS and use cases	7
2.3 New Usages of SMSs	8
3 SMS over GSM	10
3.1 GSM Architecture	10
3.2 Protocol Stack	11
3.3 The SMS Protocol Data Unit (PDU)	12
3.4 SMS Concatenation	14
3.5 Message Transmission in GSM	16
3.5.1 MS Originated SMS, Successful Transmission	16
3.5.2 Successful Transmission of an SMS towards a MS	18
3.5.3 Unsuccessful SMS Transmission	19
3.5.4 Alerting the Service Center when a Subscriber Becomes Available	20
4 Long Term Evolution	21
4.1 General Architecture	21
4.2 The Concept of Bearers	22
5 Message Transfer over IMS	26
5.1 Addressing	26
5.2 Message Service in IMS	27
5.3 Message Types	27
5.3.1 Page-Mode Message	27
5.3.2 Session-Mode Message	27
5.4 IMS Protocol Stack	28
6 Interconnection between Legacy Domain and an IMS-Based Network	30
6.1 Required Functionalities	30
6.2 The Architecture of IP-SM-GW	30
6.3 Registration Procedure	31
6.4 De-Registration Procedure	32
7 Transport Level Interworking	34

7.1	Successful Encapsulated Short Message Sent from LTE towards GSM	34
7.2	Successful Encapsulated Short Message Sent from GSM to LTE	37
7.3	Unsuccessful Short Message Termination Procedure	42
7.4	Alerting the Service Centre when the Subscriber Becomes Available	44
7.5	Alerting the Service Centre when the Subscriber Has Memory	44
8	Service Level Interworking	46
8.1	UE Sends an Instant Message to an SMS User	46
9	Conclusions	49
	Annex 1. SMS PDU in GSM – excerpt from 3GPP 23.040	50
	Annex 2. MT Correlation ID – excerpt from 3GPP 23.040	56
	Bibliography	57
	Acronyms	59

## Table of Figures

Figure 1.	GSM Architecture; source: [4]	10
Figure 2.	Protocol implemented for SMS; source: [Lag00, page 322]	11
Figure 3.	SMS Message Types	12
Figure 4.	PDU of an SMS-DELIVER in GSM	13
Figure 5.	Concatenation of a compressed short message; source: [23040]	14
Figure 6.	TP-User-Data for uncompressed GSM 7 bit default alphabet data; source: [23040]	15
Figure 7.	SMS Segmentation Process	15
Figure 8.	Successfully sent message by the MS; source: [Lag00, page 323]	16
Figure 9.	The evolution of the PDU	17
Figure 10.	Successful transmission of an SMS towards a MS, source: [Lag00, page 324]	18
Figure 11.	Unsuccessful delivery of SMS in GSM; source: [Lag00, page 325]	19
Figure 12.	SMS retransmission after failure case; source [Lag00, page 325]	20
Figure 13.	LTE Architecture; source [7]	21
Figure 14.	EPS Bearer Service Architecture; source: [36300]	22
Figure 15.	UE Triggered Service Request Procedure	24
Figure 16.	Network triggered Service Request	25
Figure 17.	IMS identification	26
Figure 18.	Message Structure, source [Cam08]	27
Figure 19.	IMS Protocol stack	28
Figure 20.	Basic IM session; source [4975]	28
Figure 21.	IP-SM-GW architecture	30
Figure 22.	Registration procedure	32
Figure 23.	De-registration procedure	33
Figure 24.	Transport level interworking - Protocol Stack	35
Figure 25.	Successful encapsulated Short Message procedure from LTE to GSM	36
Figure 26.	Successful encapsulated Short Message sent from GSM to LTE	38
Figure 27.	Delivery Report procedure (for a Short Message sent from GSM to LTE)	40
Figure 28.	Unsuccessful Short Message termination procedure	42
Figure 29.	Alert Service Centre procedure when UE becomes available	44
Figure 30.	Alerting the Service Centre when the subscriber has memory	45
Figure 31.	Service level interworking - Protocol Stack	46
Figure 32.	UE sends an Instant Message to an SMS user	47
Figure 33.	The PDU of an SMS DELIVER	50
Figure 34.	The PDU of an SMS-DELIVER-REPORT for error	51
Figure 35.	The PDU of an SMS DELIVER-REPORT for Relay Protocol Acknowledge	51
Figure 36.	The PDU of an SMS-SUBMIT	52
Figure 37.	The PDU of an SMS-SUBMIT-REPORT for error	52
Figure 38.	The PDU of an SMS-SUBMIT-REPORT for acknowledge	53
Figure 39.	The PDU of an SMS-STATUS-REPORT	54
Figure 40.	The PDU of an SMS COMMAND	55

## 1 Context

The Short Message Service (SMS) was introduced in 1992 as a successor to the paging service. In spite of the fact that at the time it was thought to be a temporary utility, it has since then proven to be widely popular.

In spite of the emerging Over-The-Top (OTT) applications that replace a part of the SMS traffic, the SMS based services are still essential to the operators. According to CTIA [1], 2.273 trillion SMSs were sent in 12 months June 2011 – June 2012 (3% more than during the previous year) in USA alone. Moreover, the *Application to Person* and *Machine to Machine* types of SMSs are more and more used for a variety of services – advertising, intelligent transportation, medicine and others.

Since SMSs represent a large part of the operator's revenue – up to 50% of their data revenue [2], it is essential that this service can be implemented on the Next Generation Network – Long Term Evolution (LTE).

LTE was initially specified as an all-IP based network – unlike GSM, it does not offer any particular integrated services – the services provided to users being those existing over IP (Web, VoIP, etc.). Although it offers very high data rates and adaptable quality of service, it does not support the SMS legacy service of GSM.

3GPP is currently specifying two architectures for SMS transmission over LTE in Release 11. The objective of this report is to describe and analyze these architectures with a particular focus on the new gateway called IP-SM-GW (IP Short Message Gateway). For the LTE network to be widely deployed, it must be able to fully provide the traditional voice and SMS services. The following aspects will be presented: section 2 describes general SMS characteristics and use-cases, section 3 describes the SMS service in GSM, section 4 presents the LTE architecture, section 5 describes messages over IMS, section 6 presents the element needed for interconnecting the 2G/3G networks to LTE for SMS transmission, section 7 and 8 present the two different types of interworking needed for a full service and section 9 presents the conclusions.

## 2 Short Message Service

### 2.1 General features

The SMS is a way for subscribers to send and receive instant text messages. An SMS can be sent or received from different devices like cell phones, computers, tablets, fixed phones. These text messages can be composed of a maximum of 140 bytes (1120 bits) of data that will be transmitted through a network. They are coded on 7, 8 or 16 bits, resulting in 160 ( $160 \cdot 7/8$ ), 140 ( $140 \cdot 8/8$ ) or 70 ( $70 \cdot 16/8$ ) characters that a subscriber can write [23040]. The choice of the number of bits on which to code a message is done depending on the characters of the text. The 7-bit encoding is the default setting, and special characters such as “\ ^ € { } [ ] ~” take up two 7-bit characters. The 8-bit encoding is necessary for sending special characters such as “š ž ê”. The Chinese, Arabic, Thai, Cyrillic alphabets are coded on 16 bits.

From a user perspective however, more characters can be sent in one text. This is done by concatenating several SMSs, operation which will be presented in detail in chapter 3.4.

SMS is a *Store and Forward* service, meaning that instead of being transmitted directly to the destination, messages are first sent to an entity called *Service Center* (SC) and then forwarded to the recipient. This is a very important characteristic, because if the recipient is not connected, the message is saved in the SC and the network keeps in mind that there is a pending SMS – when the receiver becomes available, the network will contact the SC and the latter one will forward the SMS.

Another important feature is the possibility of *confirmation* of delivery of SMS. The sender can choose to be informed when the message delivery is complete, namely when the corresponding user has correctly received the message.

### 2.2 Types of SMS and use cases

According to [3], the vast service of SMS can be classified into four categories:

- *Person to person* (P2P): the message is sent between two subscribers.
  - o Chatting: using a chat channel, similar to the internet groups.
- *Application/Advertiser to person* (A2P): used for the purpose of advertising, it implies massive transmission of a “bulk SMS” to a given list of numbers.
- *Person to Network* (P2N) or *Person to Application* (P2A): used when the subscribers send an SMS in order to access different kind of services like weather information, ringtone/picture download, tele-voting.
  - o Mobile Banking: allows subscribers to check their account balance.
  - o Electronic Commerce: allows making payments and transferring money.
- *Internet to Person* (I2P): sending an SMS from a web-page accepted by the operator.
  - o Alerting subscribers that they have received a voice message, fax or email.
  - o Corporate Email: similar to the email notifications, but this service uses the corporation’s infrastructure, forwarding all received emails of the employees to their phones.



- Information services: subscribers can subscribe to these services and receive messages regarding sport scores, flight information, news headlines, jokes etc.
- *Machine to Machine (M2M)*: a device that captures information and sends it to another device or a server. Used in navigation, traffic information, road tolling, industrial alarms and controls, monitoring vital signs etc.
  - Remote Monitoring: subscribers can choose to be informed via SMS when a certain event occurs. Examples include notifying when a vending machine is empty or meter reading.

## 2.3 New Usages of SMSs

Besides the basic use cases previously presented, there are many other interesting scenarios for using SMSs. These use-cases are some of the reasons why the SMS will not be rendered obsolete in the years to come. Below are some examples.

### **Early Flood Alerts Using Short Message Service (SMS) [End12]**

This scenario presents a solution for informing the public of a forthcoming flood, in order to minimize the accident risk and the financial loss. The system is configurable via an SMS – the clients that will be warned and the level of the water can be specified. It uses a solar cell to obtain power, an ultrasonic sensor to measure the level of the water and a microcontroller to process this data and send it to a GSM modem via SMS. The modem can then forward the SMS to the subscribed clients.

### **An Efficient SMS-Based Framework for Public Health Surveillance [Pra13]**

Another usage of the short message service is in the domain of Public Health Surveillance. The SMS infrastructure can be efficiently used in order to collect on demand health data from a target population. This information is then analyzed and the interpretation can be used in order to anticipate disease outbreaks and implement health policy programs. The usage of SMS has the advantage that GSM network is widely developed, in rural as well as urban areas. This method is faster and more ecological than the ancient one which implies filling in papers.

### **Intelligent Fish Disease Diagnostic System Based on SMS Platform [Mia13]**

This scenario was developed for fish farmers who wish to obtain in a simple and cheap way a diagnosis from an intelligent-diagnosis-system. This was thought of for two reasons: firstly the diseases in fish have an increased occurrence during the last years, and secondly the solution found had to be affordable (in the situation where an expert is not always available) and had to reach places without access to the Internet. The intelligent diagnosis system is built using a probabilistic graphical model (Bayesian networks). The farmer sends an SMS with the symptoms, the system extracts and analyzes and answers with a diagnosis and treatment.

### **A Novel Vehicular SMS System (VSS) Approach for Intelligent Transport System (ITS) [Sum11]**

This scenario seeks a possible solution to diminish the traffic congestion and the number of traffic accidents. For this purpose, the Intelligent Transport System sends safety information to the highway users via the short message service. Instead of deploying a new *Vehicular Ad hoc Network* to support the traffic data transmission, the GSM network can be used, this last solution being more cost effective.

#### **Real-time Remote Monitoring and Warning System in General Agriculture Environment [Zhu11]**

This scenario proposes a low-cost real-time remote environmental monitoring system based on short messages. This solution consists of a wireless environment monitoring equipment (WEME), using solar power, mobile phones for parameters management and some configuration settings. Depending on the needs, several sensors can be installed and connected to the WEME. When the parameters exceed their threshold range, the system will send a real time warning message to the mobile phone. On small-scale agriculture, this system represents a viable solution for the monitoring and warning over the environments' status.

### 3 SMS over GSM

According to [Tro10], the SMS concept was initially defined in 1984, and standardized in 1987 in GSM 02.03. The first accepted tests were performed in 1992. By 1996 it was working at an international level on any new mobile terminal.

#### 3.1 GSM Architecture

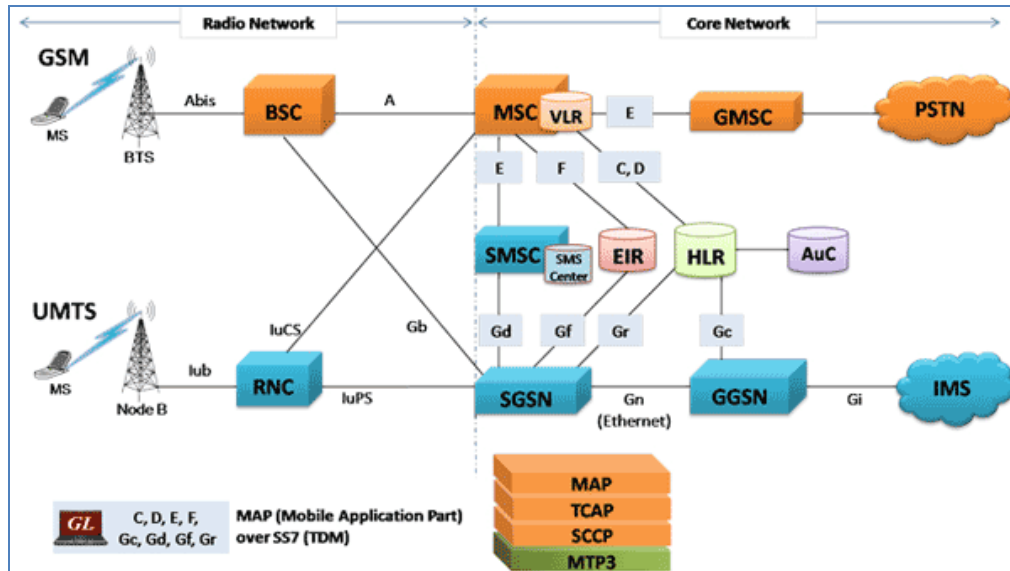

Figure 1. GSM Architecture; source: [4]

For the transmission of SMSs in GSM, a special server called *SMS Center* (SMSC or SC) has to be implemented. As presented in chapter 2.1, the SC is in charge of the *Store and Forward* function.

The device that is responsible for sending or receiving SMSs is the SME – Short Message Entity. According to [23040] the SME can be located in a fixed network, an MS, or an SC.

Although the SC does not belong to the GSM network, physically it can be integrated in the same machine as the MSC. The SC is allocated an E.164 number in the Public Land Mobile Network (PLMN) numbering plan.

The communication between the SC and the mobile terminal takes place through the MSC. The MSC is in charge of switching functions for all the calls in a certain geographical area.

The *SMS Gateway MSC* (SMS-GMSC) is responsible for forwarding the SMS to the destination Visiting MSC (VMSC) and returning the appropriate error information if it's the case. It will also inform the Home Location Register (HLR) of the delivery status of the message.

In order to reach the SC, the PLMN has to send the message from the VMSC to the MSC where the SC is situated. The latter one is called *SMS-Interworking MSC* (SMS-IWMSC). It can receive the message from the PLMN and send it to the recipient SC.

## 3.2 Protocol Stack

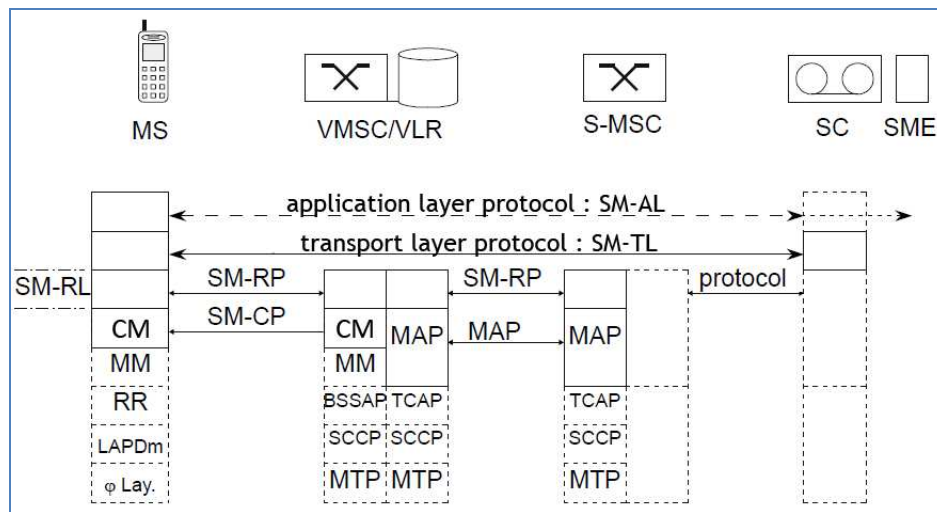

Figure 2. Protocol implemented for SMS; source: [Lag00, page 322]

The protocol layers used in order to transmit an SMS can be seen in Figure 2. The layers used during calls (Mobility Management *MM*, Radio Resource *RR*, Link Access Protocol on the *Dm* channel *LAPDm*, and Physical Layer) are also represented. The Connection Management *CM* layer includes a specific sublayer for the SMS.

There are 4 layers involved in the transmission of SMS:

- The *Short Message Application Layer* (SM-AL): is present in the mobile terminal and the Short Message Entity (SME). Its purpose is to generate and interpret messages.
- The *Short Message Transfer Layer* (SM-TL): offers the SM-AL a reliable service in order to transfer and receive short message between MS and SC. It performs the coding, and adds a timestamp of when the message was received by the server.
- *Short Message Relay Layer* (SM-RL): allows the transfer of messages through different equipments using Store and Forward. In GSM 2 protocols are specified for this layer:
  - o Short Message Relay Protocol (SM-RP): it's used between the mobile terminal and the VMSC/VLR. It manages the references and addressing.
  - o Mobile Application Protocol (MAP): it's used between the VMSC/VLR and the SMS-IWMSC.
  - o The protocol between the SMS-GMSC/SMS-IWMSC and the SC does not concern GSM standards.
- *Connection Management* (CM): The Short Message Control Protocol (SM-CP) works between the MS and the VMSC/VLR. It transmits the SM, and protects against loss caused by changing the dedicated channel (this is needed because when changing the dedicated channel, the *LAPDm* demands a new one, and does not secure the transmission).

### 3.3 The SMS Protocol Data Unit (PDU)

At the SM-TL layer, there are six types of possible PDUs, representing different ways of coding and structuring the information. The PDU contains the SCA (Service Center Address) and the TPDU (Transfer Protocol Data Unit). The six types can be differentiated due to the MTI (Message Type Indicator) field. They are presented in detail in Annex 1 and their most important behavior is presented below. [23040]

When an SMS-SUBMIT or SMS-COMMAND is sent, the SC sends a submission report to the SME indicating that it accepted the SMS for delivery. The SC will then attempt to deliver the message as soon as the subscriber is available. When this happens, if the sender has demanded it, a delivery report is returned indicating that the SMS has correctly arrived at the recipient's device.

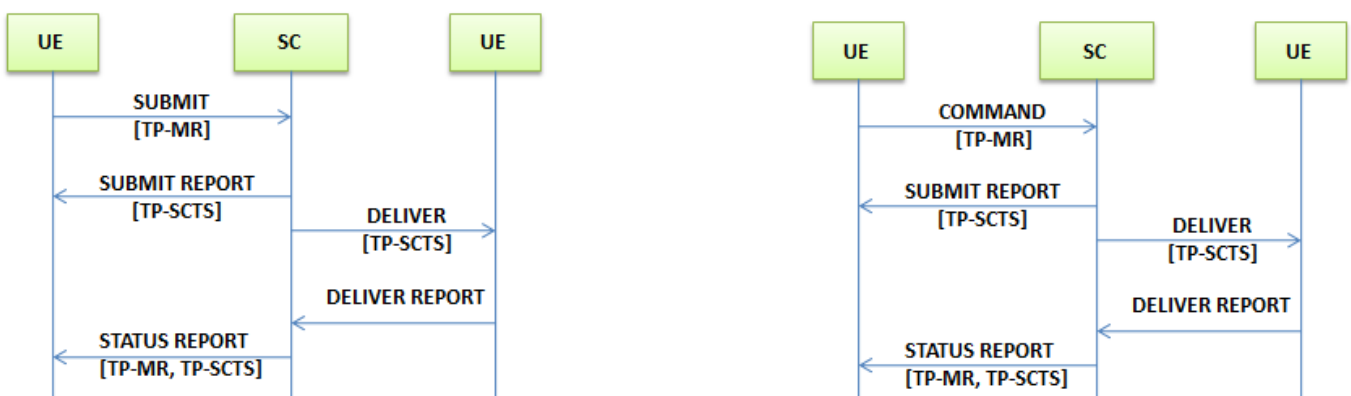

Figure 3. SMS Message Types

- **SMS-SUBMIT**: in charge of transporting messages from MS to the SC; It contains the time at which the SC received the message. It may contain optional parameters such as protocol identifier, coding scheme, data length and data. It contains *TP-MR* (Message Reference), a parameter which uniquely identifies it.
- **SMS-COMMAND**: in charge of transporting a command from the MS to the SC. It contains *TP-MR* (Message Reference), a parameter which uniquely identifies it. This type of message makes it possible for a MS to check the status of a short message, or delete it if it's still in the SC. An SMS-COMMAND can also be used to obtain information about the subscriber (MSISDN and IMSI). An SMS-STATUS-REPORT may be received as a result of the command. [23040]
- **SMS-SUBMIT-REPORT**: in charge of transporting
  - the cause of failure
  - the acknowledgement for an SMS-SUBMIT, or SMS-COMMAND;

An SMS-SUBMIT-REPORT is issued by an SC as a positive or negative acknowledgement to an SMS-SUBMIT or an SMS-COMMAND. In case of failure it contains a field which offers information on the reason of failure.

It contains the *TP-SCTS* (Service-Centre-Time-Stamp), a parameter which identifies the time at which the SC received the message (SMS-SUBMIT or SMS-

COMMAND). This value is kept unique even if more messages are sent simultaneously – to ensure that, the SC will slightly modify the time value stored in it.

- **SMS-DELIVER:** in charge of transporting messages from SC to the MS;  
It will contain an indication of whether or not it is a part of a concatenation, the address of the originating SME, the coding scheme used, the time at which it was received by the SC, the length of the user data, and the message itself. It contains the *TP-SCTS*.
- **SMS-DELIVER-REPORT:** in charge of transporting
  - the cause of failure
  - the acknowledgement for an SMS-DELIVER or an SMS-STATUS-REPORT;

An SMS-DELIVER-REPORT is issued by an MS as a positive or negative acknowledgement to an SMS-DELIVER or an SMS-STATUS-REPORT. In case of failure it contains a field which offers information on the reason of failure. It is sent to the SC.

- **SMS-STATUS-REPORT:** in charge of transmitting a status report from the SC to the MS;  
An SMS-STATUS-REPORT is issued by the SC and it concerns the final state of an SMS-SUBMIT or SMS-COMMAND. It will contain both the *TP-MR* and the *TP-SCTS* allowing the sender UE to correlate the SMS-STATUS-REPORT to the SMS it has sent.

An example of a sent message of the PDU of the SMS-DELIVER can be seen in Figure 4.

07	91	1326040000F0	04	0B	91	1346610089F6	00	00	20806291731408	0C	C8F71D14969741F977FD07
Length of the SMSC information	Type of address of SMSC	SMSC number	First octet of this SMS-DELIVER message.	Length of the sender's address	Type of address of the sender	Sender's number	Protocol ID	Data encoding scheme	Time stamp	Length of User data	User Data = SMS message

*Figure 4. PDU of an SMS-DELIVER in GSM*

### *The Link between the SMS-PDUs*

“An active MS shall be able to submit a short message TPDU (SMS-SUBMIT) at any time, independently of whether or not there is a speech or data call in progress. A report shall always be returned to the MS; either confirming that the SC has received the short message TPDU, or informing the MS that it was impossible to deliver the short message TPDU to the SC, including the reason why.” [23040]. This implies that the sender is always able to associate an SMS-SUBMIT-REPORT to an SMS-SUBMIT.

“The SC is only allowed to have one outstanding SMS-DELIVER (i.e. a message for which a report has not been received) to a specific MS at a given time.” [23040] Therefore, upon the reception of an SMS-DELIVER-REPORT, the SC can easily correlate it to the *TP-*

MR and TP-SCTS and generate the SMS-STATUS-REPORT using these values. This implies that the sender can now relate the received SMS-STATUS-REPORT to the corresponding SMS-SUBMIT.

### 3.4 SMS Concatenation

Texts larger than 160 characters are segmented by the network. The receiver then needs to concatenate the pieces. For concatenation to be possible, a header is added to the Protocol Data Unit (PDU) of the SMS – this header is called User Data Header (UDH).

This header occupies 6 bytes, which means that for a GSM 7 bit default alphabet data only 134 bytes remain for the SMS characters.

The maximum number of SMSs that can be concatenated in this way is 255, resulting in a maximum length of the concatenated message of 34 170 bytes (255\*134 bytes). If the message is compressed – Huffman algorithm is most often used in GSM – then these bytes also include the Compression Header and the Compression Footer as seen in Figure 5. The Compression Header defines the type of compression applied, and the Compression Footer indicates the end of the Compressed Data.

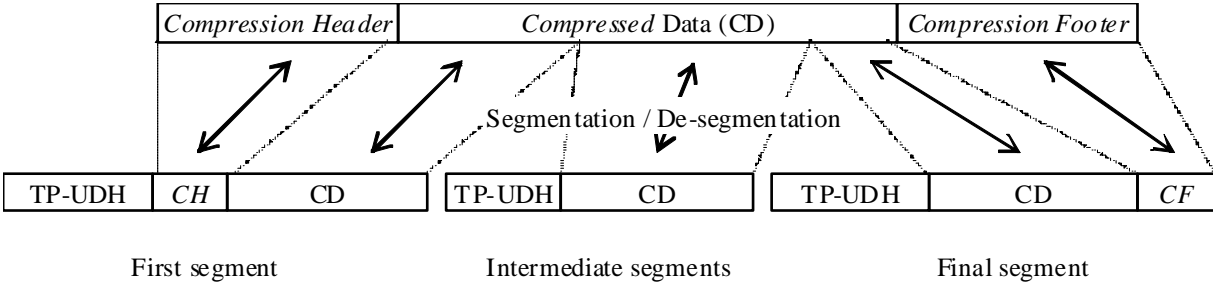

Figure 5. Concatenation of a compressed short message; source: [23040]

The TP-User-Data for uncompressed GSM 7 bit default alphabet data can be seen in Figure 6.

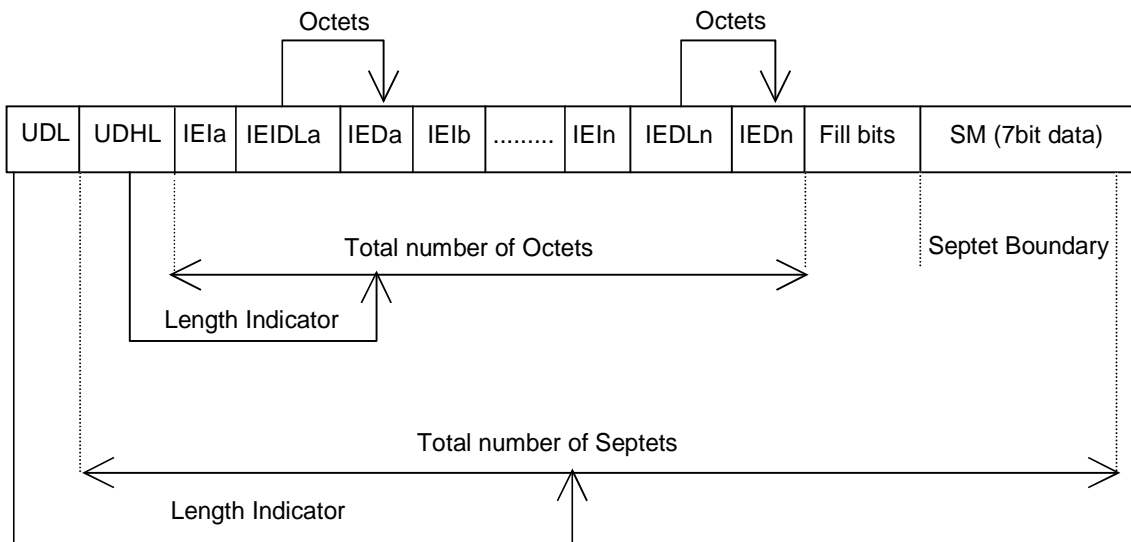

Figure 6. TP-User-Data for uncompressed GSM 7 bit default alphabet data; source: [23040]

The TP-UDL (Transfer Protocol User Data Length) represents the total length of the User Data. The UDHL (User Data Header Length) gives the number of bytes of the User Data Header.

The IEI (Information Element Identifier) is a field used for SMS Control, EMS (Enhanced Messaging Service) Control and EMS Content. When related to concatenation, it can take two values: 00 or 08. It is followed by a field IEIDL (IEI Data Length) which gives the number of bytes of the IEID (IEI Data).

The IEID will contain IEIDL-2 bytes that identify the messages belonging to the same set, one byte that says in how many SMSs the original message was split (maximum value FF), and finally one byte that indicates the current number of the message.

An example of a segmented text is found in the Figure 7.

First SMS: 06 08 04 F4 2E 02 01 .. bytes that make up the first part text ..  
 Second SMS: 06 08 04 F4 2E 02 02 .. bytes that make up the second part text ..

Information Elements (IE)	}	<p>BytesDescription</p> <p>06 The UDHL, or length of the UDH. So the following six bytes are UDH</p> <p>08 This is the IEI: Identity Element Identifier This identifier says this is a concatenated message with 16-bit reference</p> <p>04 This is the IEDL: IE Data Length. It says that next 4 bytes are the data for this IE.</p> <p>F42E The reference number of this concatenated message. Each part must have the same reference number.</p> <p>02 There are two parts to this concatenated message.</p> <p>01 or 02 This indicates whether the SMS is the first or second part.</p>
---------------------------	---	---

Figure 7. SMS Segmentation Process



## 3.5 Message Transmission in GSM

### 3.5.1 MS Originated SMS, Successful Transmission

Figure 8 presents the call flow generated at the transmission of an SMS by a MS. The message sent by the subscriber is coded by the transport entity of the mobile in 140 bytes also adding the address of the recipient, resulting in a *Transfer Layer* PDU (TL-PDU). At the *Relay Layer*, the address of the SC is added to the TL PDU. The new packet is called *Relay Protocol-DATA* (RP-DATA). This packet is encapsulated in a *Control Protocol* (CP) level PDU, but at this stage no important information is added. This packet is called PDU *CP-DATA* and it is transported towards the VMSC/VLR due to *SM-CP* and its lower layers.

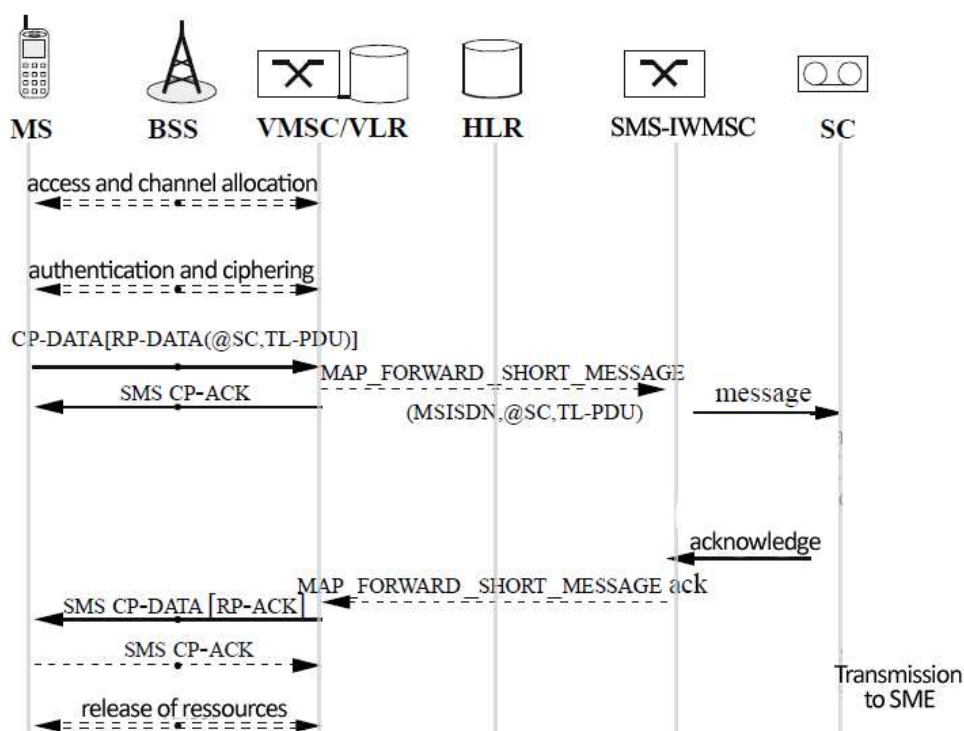

Figure 8. Successfully sent message by the MS; source: [Lag00, page 323]

As seen in the Figure 9, the VMSC/VLR decapsulates the PDU *CP-DATA* in order to find the SC number and then replaces in a *MAP\_FORWARD\_SHORT\_MESSAGE* the TL PDU, the number of the SC and the number of the mobile. The MAP message is acknowledged by the SMS-IWMSC which will forward the message to the SC.

Note that as opposed to what is suggested in figure 3 *SMS-SUBMIT-REPORT* is not transmitted by the SC to the MS but locally generated in the MS. If the SC correctly stores the message, then a positive acknowledgement is sent to the VMSC/VLR (i.e. message *MAP\_FORWARD\_SHORT\_MESSAGE* ack) and then a *RP-ACK* is sent to the mobile which is equivalent to a positive *SMS-SUBMIT-REPORT*. If there is a problem in the transmission chain, a negative *SMS-SUBMIT-REPORT* is generated. For instance, if the SC is unreachable, the SMS-IWMSC sends a *MAP\_FORWARD\_SHORT\_MESSAGE* nack that

includes the cause of the failure. The cause is read by the MSC-VLR and put into the RP-ACK which is received by the mobile station (see 9.2.2.1a (ii) ).

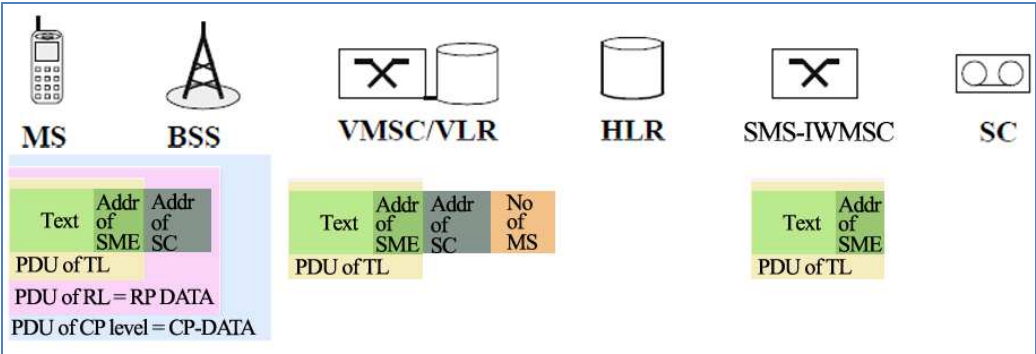

Figure 9. The evolution of the PDU

The SC stores the message and the addresses, and sends back to the SMS-IWMSC an acknowledgement message. The SMS-IWMSC can acknowledge now the packet received from the VMCS/VLR (through the TCAP operation *Return Result*). The VMSC/VLR will format the acknowledgement message PDU *RP-ACK* which is encapsulated into a PDU *CP-DATA* and sent to the mobile station. In the end, this PDU is acknowledged by the MS.

If possible, the SC will send the SMS to the SME. If the SME is not available in the network, the SC will store the message until it can be sent. However, after a certain period, if the SMS can't be sent it is deleted from its memory. This period can be specified by the MS at the transport layer. In conclusion, the MS only has the confirmation that the message sent arrived at the SC. After receiving the SMS, the SME can send back a new message in order to confirm the correct reception; this last exchange of messages is treated differently than the first confirmation.

### 3.5.2 Successful Transmission of an SMS towards a MS

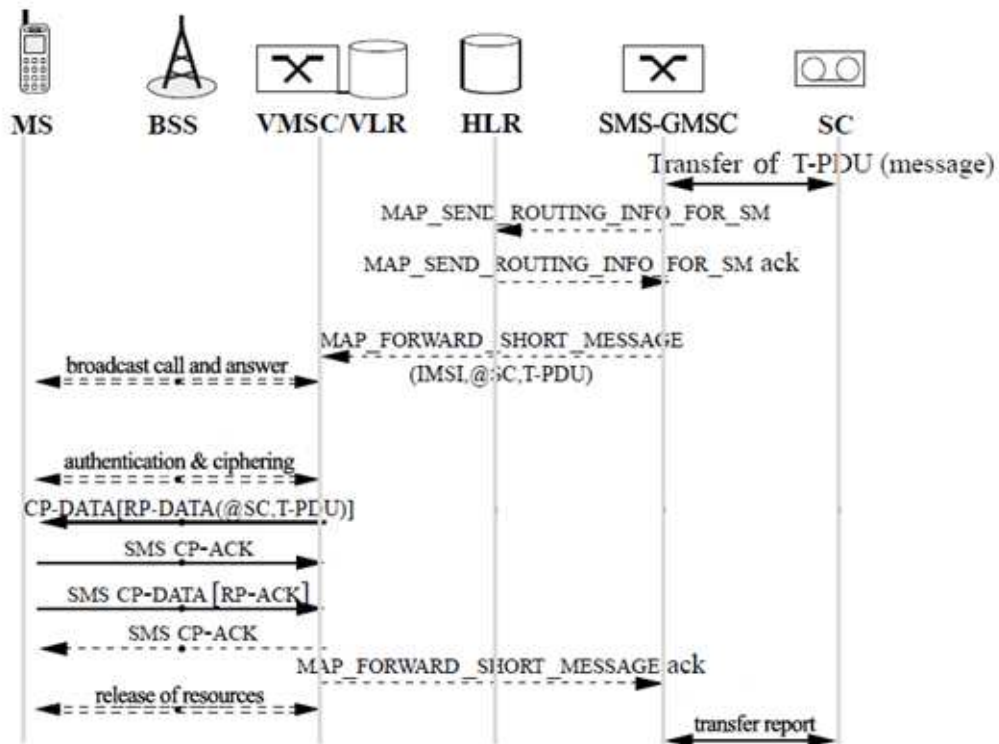

Figure 10. Successful transmission of an SMS towards a MS, source: [Lag00, page 324]

The SC creates a TL PDU which contains the message, the address of the SME and the date at which the message was received. It sends this PDU to the SMS-GMSC.

The SMS-GMSC adds the address of the SC to the PDU. Then, it interrogates the HLR to find the location of the MS – finding its IMSI, and sends the message through the VMSC/VLR using MAP\_FORWARD\_SHORT\_MESSAGE.

During this message transfer, the same protocols as in case 3.5.1 are used.

### 3.5.3 Unsuccessful SMS Transmission

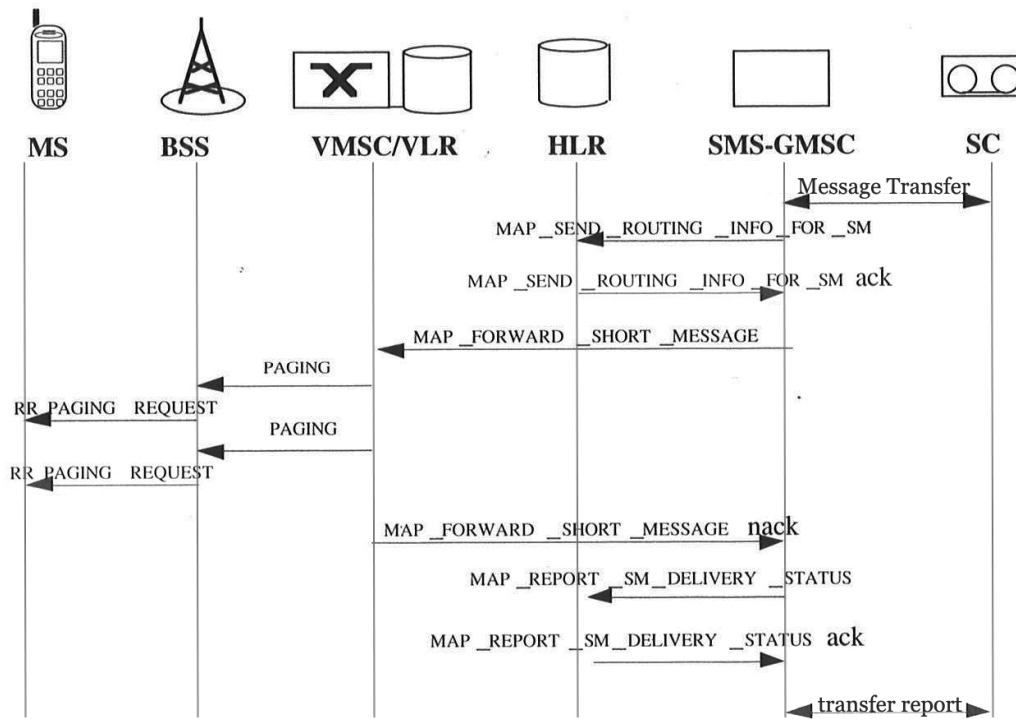

*Figure 11. Unsuccessful delivery of SMS in GSM; source: [Lag00, page 325]*

After the submission of the SMS to the SC (Figure 8), the SC attempts to transmit the message to the receiver SME similarly to the scenario presented in Figure 10. However, if this subscriber is not present in the network, it will not be able to respond to the *Paging* message sent by the VMSC. After a certain time, the VMSC realizes that the subscriber is not present in the network, and sends a *MAP\_FORWARD\_SHORT\_MESSAGE\_nack* informing the SMS-GMSC. The SMS-GMSC will then inform the HLR which updates its *Message Waiting Data* list storing also the address of the corresponding SC. Then it also informs SC of the transmission failure.

### 3.5.4 Alerting the Service Center when a Subscriber Becomes Available

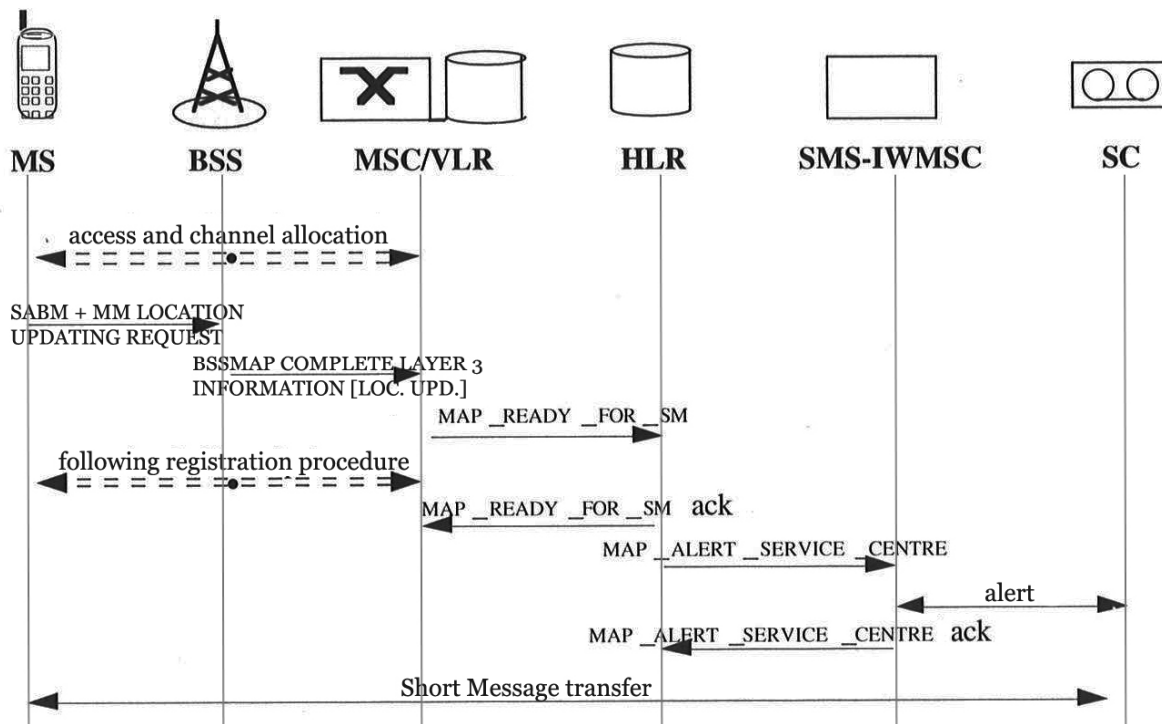

Figure 12. SMS retransmission after failure case; source [Lag00, page 325]

When the receiver becomes available in the network, the VLR announces the HLR using a *MAP\_READY\_FOR\_SM* message. The HLR sends a *MAP\_ALERT\_SERVICE\_CENTRE* message to the SMS-IWMSC, which will in turn alert the SC. The SC then proceeds to transmit the short message (see Figure 10).

## 4 Long Term Evolution

LTE is a 4<sup>th</sup> Generation (4G) standard for wireless communication which provides seamless IP connectivity, developed by the 3rd Generation Partnership Project (3GPP). It offers an increased capacity, allowing more than voice calls – due to its higher data throughput it is a multiservice air interface. Unlike previous cellular systems, inside LTE all services are packet-switched (PS).

As it is signaled by *IHS iSuppli Wireless Communications Special Report* [5], the worldwide number of LTE subscribers increased from 612,000 in 2010 to 92.3 million in 2012 and is expected to be of 1 billion in 2016. Since there are already 145 fully deployed commercial LTE networks in 66 countries around the world (confirmed by GSA - Global mobile Suppliers Association [6]), it becomes crucial to bring to the LTE subscribers all the services that they benefited from in legacy domain – i.e. sending/receiving SMSs.

### 4.1 General Architecture

Together, the core network and the radio access form the Evolved Packet System (EPS) presented in Figure 13. The core network architecture is the System Architecture Evolution (SAE), and it includes the Evolved Packet Core (EPC) network.

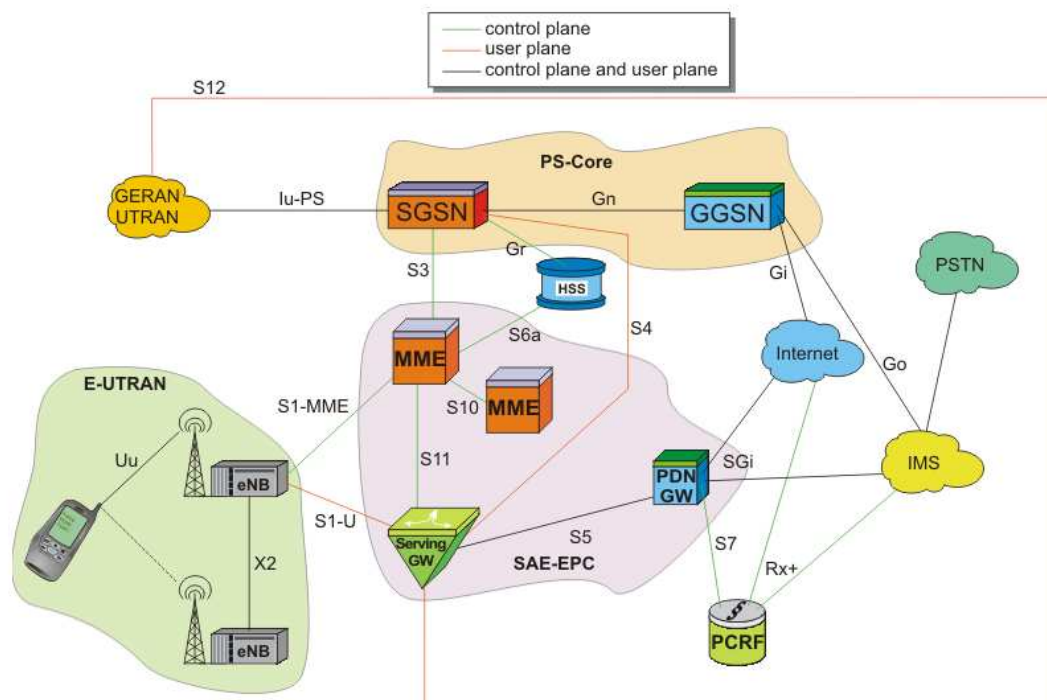

Figure 13. LTE Architecture; source [7]

The *eNBs* (Evolved NodeB) create the E-UTRAN. Their functions include radio resource management and control, making handover decisions, selecting the MME (Mobility Management Entity) when a new user enters the network, encryption.

The MME performs bearer control (activation/deactivation), mobility management, selects the S-GW (Serving Gateway) for the UE, authenticates the UE, allocates temporary identities, tracks area updates, stores UE context, and is the control plane function for

mobility between LTE and legacy access networks (being connected to the SGSN – Serving GPRS Support Node).

The S-GW’s main function is realizing a mobility anchor, which means that during a handover it continues to forward the packets to the UE.

The P-GW (Packet Data Network Gateway) realizes the interface towards external packet data networks such as the internet or IMS. It assigns the user its IP address. It is in charge of policy and charging enforcement function (QoS), packet filtering and lawful intercept.

## 4.2 The Concept of Bearers

In order to send packets in LTE, the concept of EPS bearers was developed. They are characterized by the offered Quality of Service (QoS) and they are used to route packets between the User Equipment (UE) and the gateway Packet Data Network (PDN).

When the UE connects to a PDN, the PGW associates an IP address (IPv4 or IPv6) and an EPS Bearer to it. This provides basic connectivity, and is called default bearer. It has a QoS value given by the network in correlation to the subscription. Due to the feature of always-on IP connectivity, this bearer remains established as long as the UE maintains the PDN connection. Other bearers can be associated to the same PDN for QoS sensitive applications, but they are known as dedicated bearers.

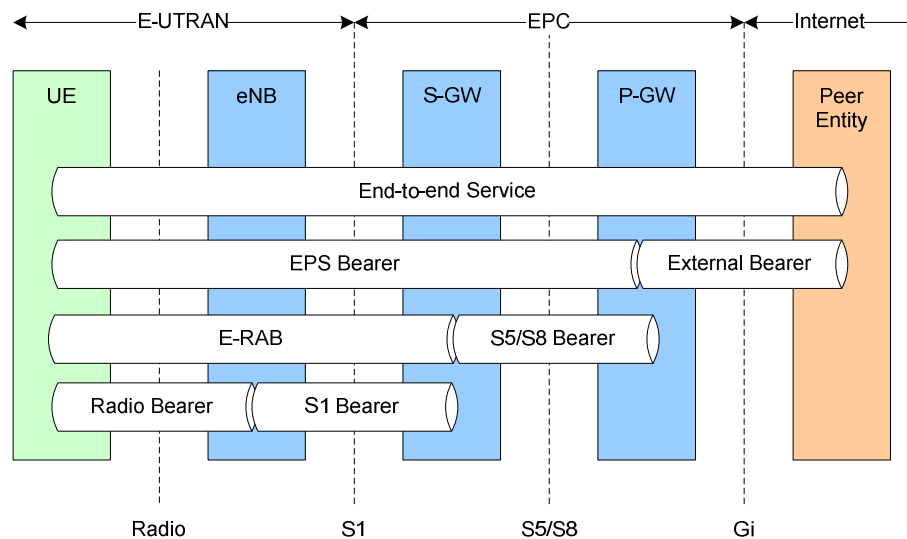

*Figure 14. EPS Bearer Service Architecture; source: [36300]*

An EPS Bearer is composed of E-RABs (E-UTRAN Radio Access Bearer). One E-RAB carries the packets of EPS Bearer between the UE and the S-GW. It is uniquely related to the EPS Bearer. From the S-GW to the P-GW, the packets travel through the S5/S8 Bearer.

A Radio Bearer carries the packets of an EPS Bearer over the Radio interface between the UE and the eNB. It is uniquely related to the EPS Bearer and to the E-RAB. From the eNB to the S-GW the packets travel through the S1 Bearer.

A mobile can be either in connected or in idle state. In *connected state* all the bearers mentioned above are maintained, the EPC and the eNB have a context of the mobile and its location is known at cell level. In *idle state* the mobile keeps its IP address and is known by the EPC, but its context is no longer kept in the eNB, there is no signaling between the UE and the MME. The Radio Bearer and the S1 bearer no longer exist. The S5/S8 bearer is maintained so the mobile can be reached.

When the UE is in idle state [23401]:

- If it wants to send data it will send a *Service Request* NAS message to the MME through the eNB. After the NAS authentication/security, the MME sends a *Context Setup Request* to the eNB. This triggers the eNB to perform the setting of radio and S1 bearers. If there are any modifications in the parameters of the message *Modify Bearer Request* received by the S-GW, then it will forward the request to the P-GW demanding the necessary modifications inside the S5/S8 Bearer.



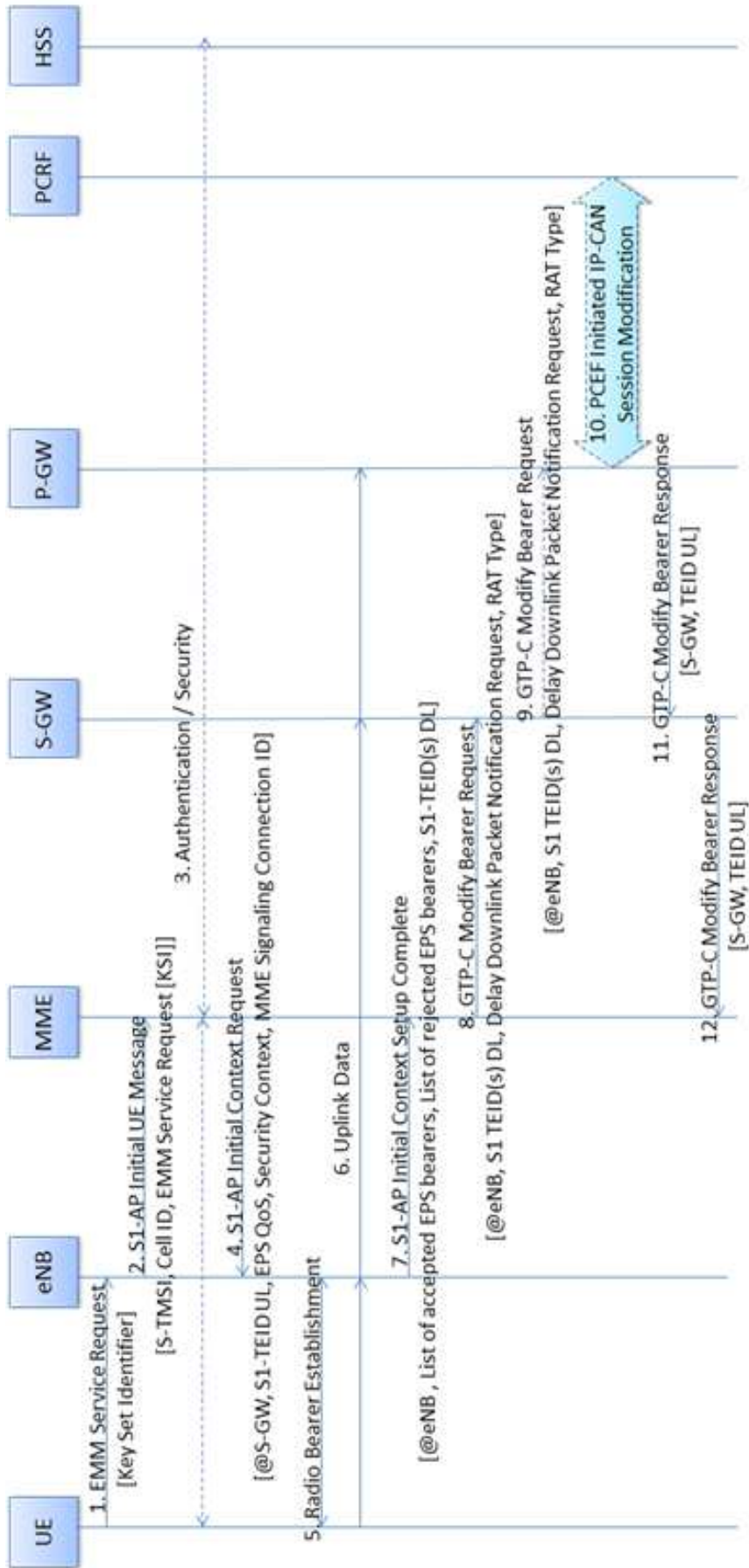
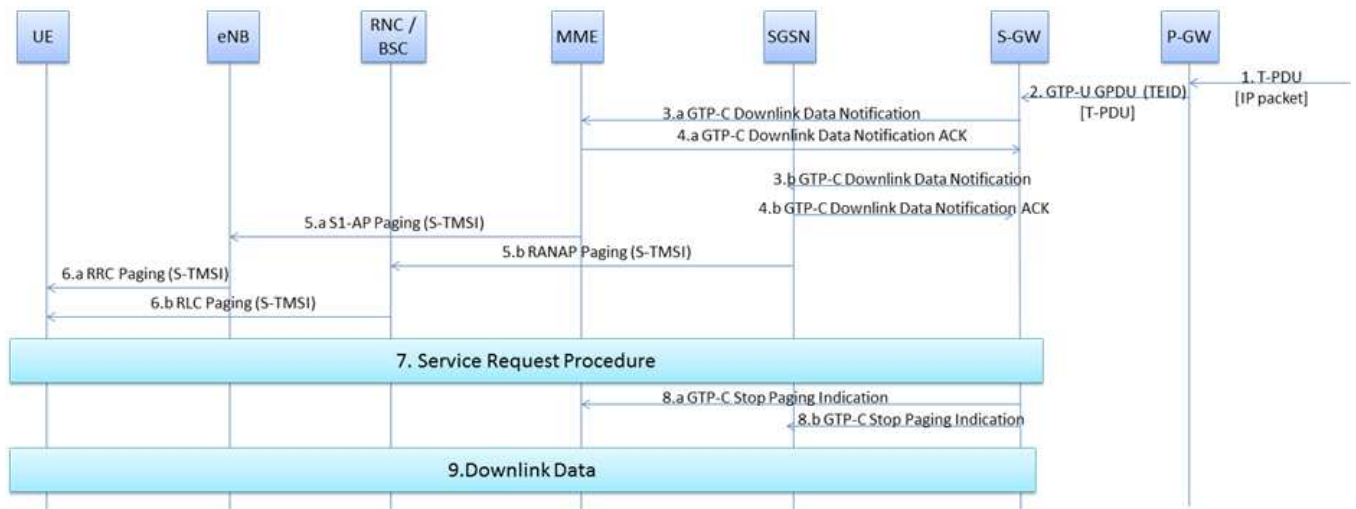

Figure 15. UE Triggered Service Request Procedure

- If the network needs to reach it, the S-GW will send a *Downlink Data Notification* message to the MME and the SGSN nodes to which it has a control plane connectivity.
  - If the UE is connected to the MME, the MME sends *Paging* messages to all eNB in the area where the UE is registered. Then the eNBs forward the Paging message to UE.
  - If the UE is connected to the SGSN, the SGSN does the same, sending messages to RNC/BSS, and the BSSs forward them to the UE.

Following the reception of a paging message, the UE send a Service Request message, as seen in the previous step. After the contexts are set, the S-GW sends a *Stop Paging* message to the MME and the SGSN.



*Figure 16. Network triggered Service Request*

## 5 Message Transfer over IMS

Since LTE is a Packet Switched network, its two components (E-UTRAN and EPC) connect to each other via IP. Therefore, in order to facilitate the implementation of legacy Circuit Switched (CS) functionalities like voice and SMS, the EPC needs to connect to another network: the IP Multimedia Subsystem (IMS). The purpose of this chapter is not to present all IMS services, but to focus on messaging.

### 5.1 Addressing

As seen in the Figure 17, the user identification in IMS defines two important types of information:

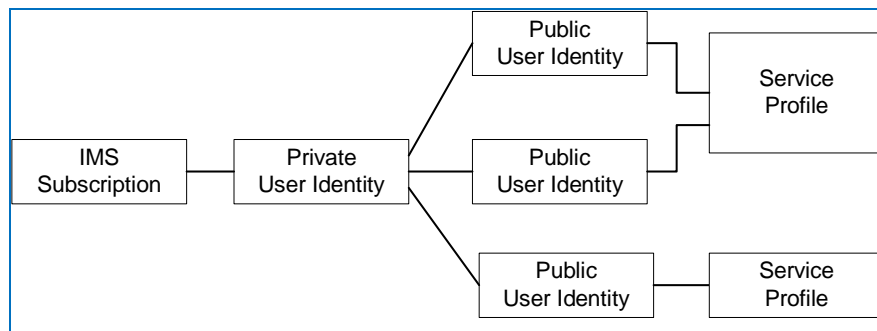

*Figure 17. IMS identification*

- The private identity described by the IMPI (IP Multimedia Private Identity) and is unique in the operator's network – it identifies the user's subscription. It remains available as long as the subscription and it concerns specifically the operator. It is important during the authentication of the terminal – it is sent during each registration procedure.
- The public identity described by the IMPU (IP Multimedia Public Identity) which allows identifying the user associated to a subscription. A user can have multiple IMPUs.

The Public identity has the form of an URI (Uniform Resource Identifier) which is a string of characters used to identify a name or a resource. There are two types of URI used in IMS:

- **Tel URI** – looks like a phone number. It can be either global (globally unique), or local (specific to a local context). It can belong to:
  - An IMS subscriber and in this case the S-CSCF uses the **Telephone Number Mapping (ENUM)** data base to translate the Tel URI to a SIP format and route the message.
  - A CS subscriber and the S-CSCF has to route the message to the appropriate Gateway

Example – global: +358-555-1234567

– local: tel:1234567;phone-context=+358-555

- **SIP URI** – its general form is:
  - [sip:user:password@host:port:uri-parameters?headers](#).
 However, its most used form is: sip:user@host. Example: [sips:bob@client.biloxi.example.com](#).

When a GSM phone number needs to be translated for usage in IMS it will have the following form: [33677851111@bouyguestel.com](#).

## 5.2 Message Service in IMS

IMS allows the sending of messages of 200 bytes with acknowledgement. The messages are sent between users in real-time. The service provides a fast enough exchange of messages for an interactive conversation to take place [3428].

## 5.3 Message Types

In IMS there are two types of messages: page-mode messages and session-mode messages [23240].

### 5.3.1 Page-Mode Message

A page-mode message is very similar to an SMS. It is a SIP MESSAGE, it is not related to previously sent messages and requires no answer. It can be a text sent between two subscribers, or a notification. The User Agent Client (UAC) sends the SIP MESSAGE to the proxy, and the proxy forwards it to the User Agent Server (UAS), which responds with a 200 OK message.

```

MESSAGE sip:bob@example.org SIP/2.0
Via: SIP/2.0/TCP alicepc.example.com;branch=z9hG4bK776sgd43d
Max-Forwards: 70
From: Alice <sip:alice@example.com>;tag=48912
To: Bob <sip:bob@example.org>
Call-ID: a3d3hdj5ws223ns6lk8djds
Cseq: 1 MESSAGE
Content-Type: text/plain
Content-Length: 31

Hi, what is going on today?
  
```

*Figure 18. Message Structure, source [Cam08]*

The general form of a SIP MESSAGE is presented in Figure 18. The first line defines the message type, followed by a number of headers used for the routing of the message and the control of the session. On the bottom we find the message body, in this case the actual text sent by the subscriber.

### 5.3.2 Session-Mode Message

For a conversation between two or more subscribers, a session-mode is used. In this mode, a SIP INVITE is used to establish a session in order to transmit instant messages (not

video or audio content). Therefore, instead of Real-time Transport Protocol (RTP) another media protocol is used: MSRP (Message Session Relay Protocol – see section 5.4). MSRP runs on transport protocols that insure end-to-end congestion control, such as TCP.

## 5.4 IMS Protocol Stack

In Figure 19 is presented the protocol stack used in IMS in order to send a message. The transport level realizes the transport of the packets, on an end-to-end basis – depending on the service offered, this can be either TCP or UDP.

The session control is performed by the SIP and SDP protocols, while the media flow are transmitted using a MSRP or RTP protocol.

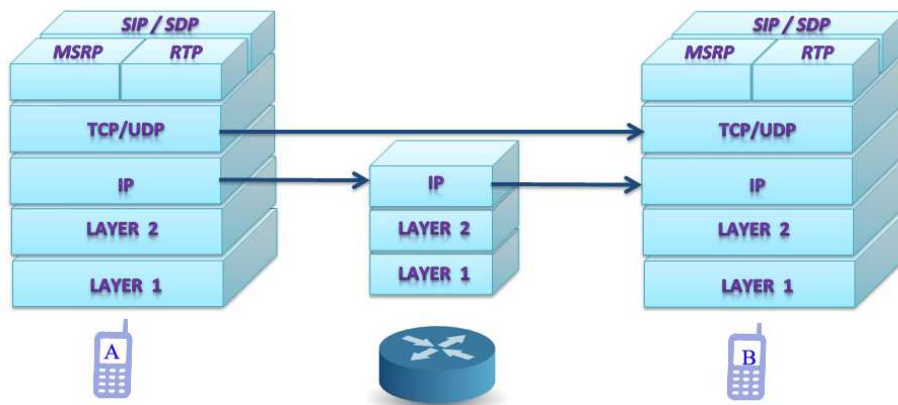

Figure 19. IMS Protocol stack

### MSRP – Message Session Relay Protocol

MSRP is a connection oriented protocol used for sending instant messages that are part of a session. The sessions of MSRP usually takes place using SIP (similarly to a video/audio session) and can be negotiated using SDP.

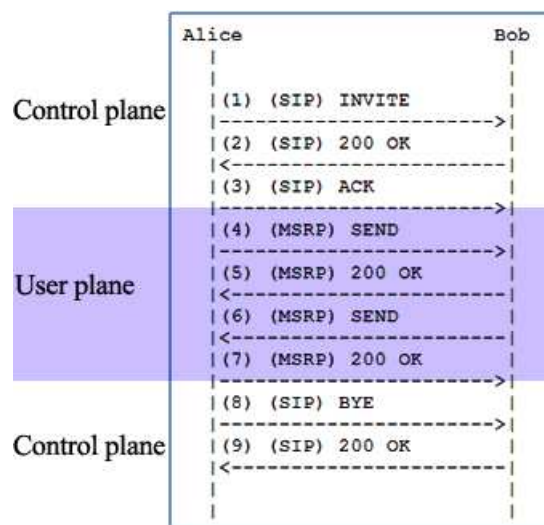

Figure 20. Basic IM session; source [4975]

A basic IM session can be observed in Figure 20. Every SIP MESSAGE contains a MSRP URI which identifies the user belonging to the session. The first 3 messages sent in the previous example realize the SIP connection and the SDP negotiation. The next message opens the MSRP connection and also contains the text to be sent. Then this message is acknowledged (200 OK) and the MSRP session continues. The session is finished with a SIP BYE message.

A MSRP URI example: *msrp://alicepc.example.com:7777/iau39soe2843z;tcp*

- *msrp* is the scheme
- *alicepc.example.com:7777* is the authority
- *iau39soe2843z* is the session identifier
- *tcp* is the transport protocol used

## 6 Interconnection between Legacy Domain and an IMS-Based Network

The interconnection between the legacy domain (i.e. GSM or UMTS) based on MAP and the LTE-EPC part based on IMS is made by a gateway called IP-SM-GW, IP-Short Message-Gateway [23824.]

### 6.1 Interfaces of IP-SM-GW

As seen in Figure 21, the IP-SM-GW is placed between the IMS core and the legacy domain. It provides the possibility for the users to register and deregister, process during which they specify their possibilities to send/receive SMSs over IP. Note that the IP-SM-GW is connected to the HLR-HSS and is able to communicate with it both with MAP and Diameter.

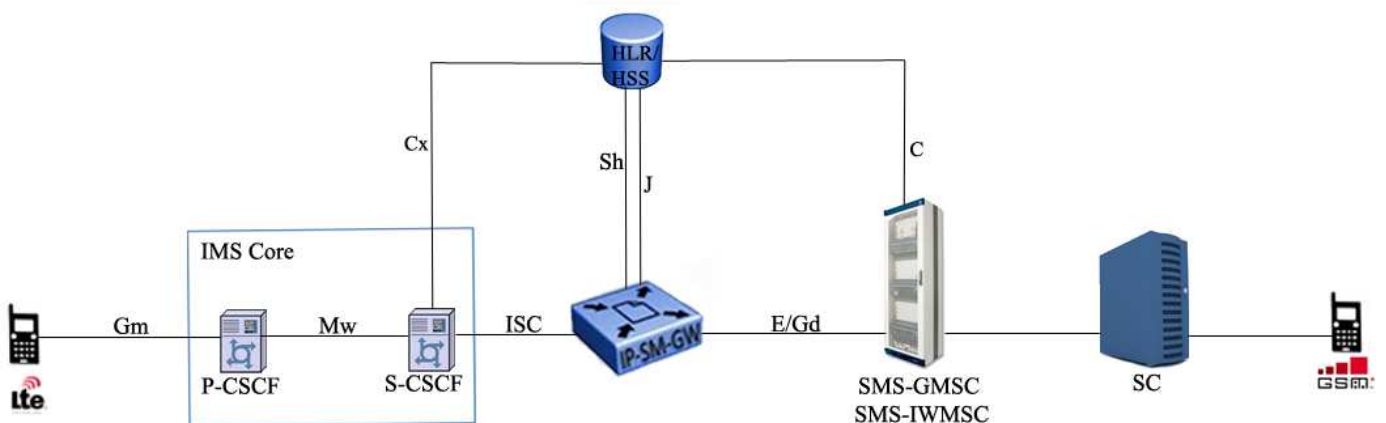

Figure 21. IP-SM-GW architecture

### 6.2 Functionalities of the IP-SM-GW

The general functionalities of the IP-SM-GW are: [23204]

- Realizes to which domain a certain short message has to be delivered: CS, PS or IMS;
- Renders the transition to the legacy domain seamless
  - the SMS-GMSC sees it as if it were MSC or SGSN, connecting to it via MAP;
  - the SMS-IW-MSC sees it as if it were MSC or SGSN, connecting to it via MAP;
- Responds with its own address to the Routing Information for Short Message requests received from the HSS;
- When sending a message to the legacy domain, it must connect via MAP to the HSS to find the address of the MSC/SGSN concerned;
- Keep a data basis of the correlation between the MSISDN/IMSI and the address of the associated S-CSCF;
- In case of a Short Message sent from IMS towards legacy domain, it must check that the sender and receiver addresses are correct in the SIP headers;

- For messages sent from legacy domain towards IP based domain, it must translate the MSISDN/IMSI to TEL URI (when available), or to SIP URI;
- Act as an Application Server for the IMS core;
- To read from the HSS and interpret the availability flags for receiving SMSs.

The general functionalities of the HSS are: [23204]

- Knows for each subscriber the address of its corresponding IP-SM-GW;
- Have flags for each subscription (terminal) which indicate its registration to an IP-SM-GW;
- Responds with the address of the MSC/SGSN to the Routing Information for Short Message requests received from the IP-SM-GW;
- Forward to the IP-SM-GW the Routing Information for Short Message received from SMS-GMSC. All the responses for this request must then be forwarded to its originator;
- When the IP-SM-GW sends a Routing Information for Short Message query, it must respond with the IMSI and the associated MSC/SGSN address;
- When the terminal is not available for the receiving of the message, the HSS stores the address of SC in the Message Waiting Data file. It must then inform the SC when the terminal becomes available for receiving the message through the IP-SM-GW;
- Send a notification to the IP-SM-GW when the user becomes available after a delivery failure;
- Accept delivery status reports from IP-SM-GWs instead of SMS-GMSC.

### 6.3 Registration Procedure

For the gateway to be able to find a UE at a given time, it must know its IP address. During the registration procedure a correlation is made between the IP address and the UE's URI. At each time a mobile changes location it must re-register.



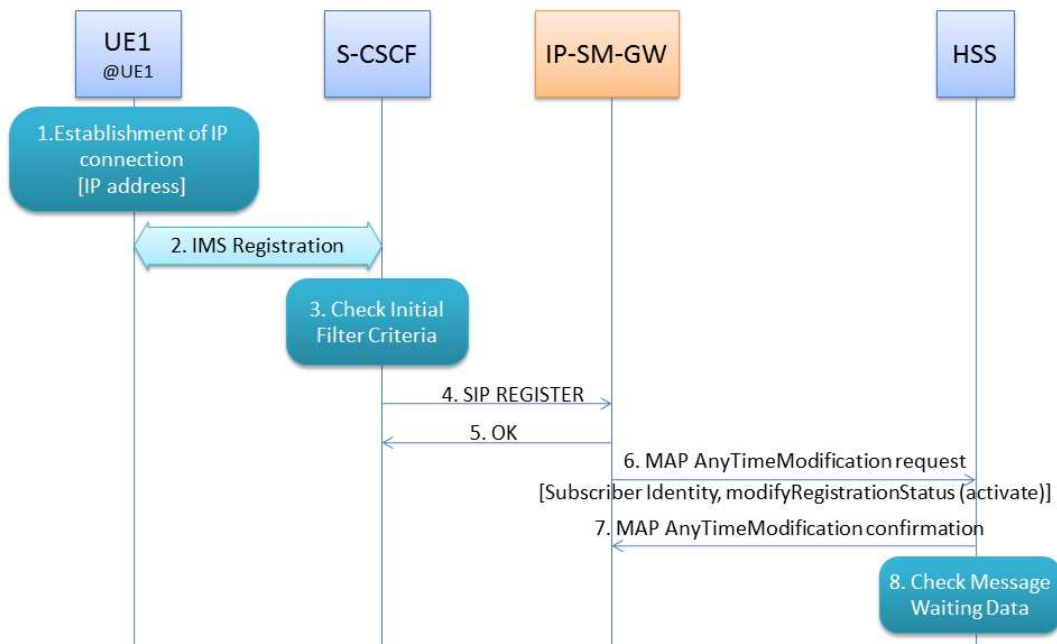

*Figure 22. Registration procedure*

The registration procedure of a User Equipment (UE), presented in Figure 22, takes place as follows [23204]:

1. The UE establishes an IP connection
2. The UE registers to the IMS network (the UE contacts the P-CSCF, and I-CSCF, then the HSS gives the address of the concerned S-CSCF; after the exchange of the authentication data and the user service profile the user is registered).
3. The service profile contains the initial filter criteria (iFC), which is checked by the S-CSCF in order to determine to which AS and services the UE has access.
4. The S-CSCF informs the AS (in this case the IP-SM-GW) of the correct registration of the UE. It sends the MSISDN or in case this does not exist, the IMSI.
5. The IP-SM-GW responds with a 200 OK message.
6. The IP-SM-GW sends a Register Request to the HSS.
7. The HSS will:
  - a. Store the address of the IP-SM-GW or
  - b. See it as an indication that the user is available via IMS for MT-SMS (Mobile Terminating SMS) without MSISDN. If the message waiting flag is set it will trigger an alert service center message.
  - c. Responds to the IP-SM-GW with a Register Response message.
8. The HSS now checks if any messages are pending for the UE, and if so alerts the corresponding SCs.

## 6.4 De-Registration Procedure

When a user wants to quit IMS services, he performs an application-level de-registration. This is presented in Figure 23.

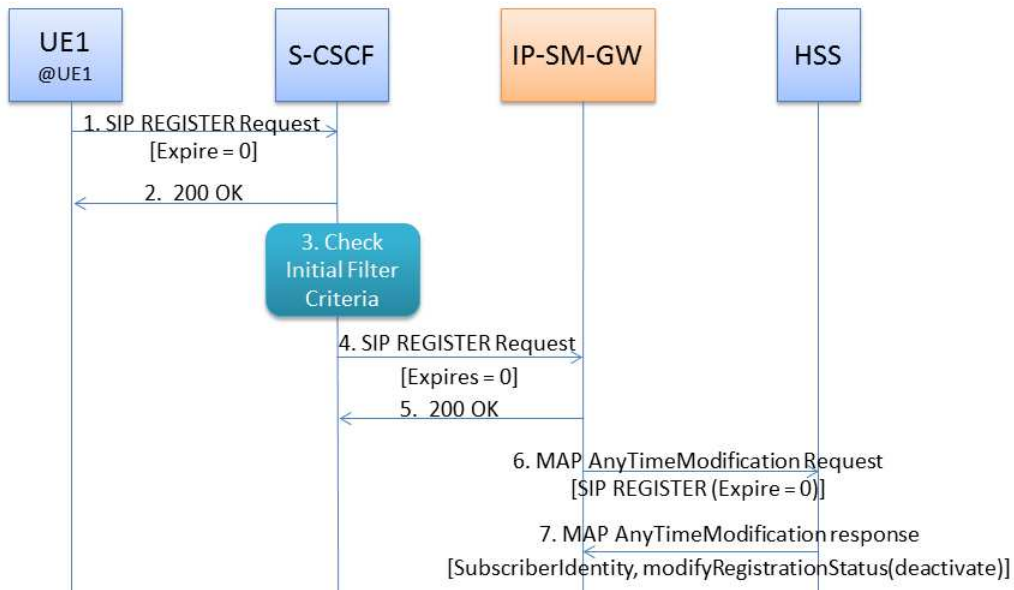

*Figure 23. De-registration procedure*

The de-registration procedure of a UE takes place as follows [23204]:

1. In order for a UE to de-register, it sends a Register request with the value of the *Expire Header 0*.
2. The S-CSCF confirms with an OK message.
3. The S-CSCF checks the initial filter criteria that it received from the HSS during the IMS registration procedure in the service profile.
4. Based on those initial filter criteria, it informs the IP-SM-GW of the de-registration.
5. The IP-SM-GW responds with an OK message.
6. The IP-SM-GW sends a de-registration request to the HSS.
7. The HSS de-registers the UE, and sends a De-register Response to the IP-SM-GW.

If the de-registration message is not properly sent, the network is allowed to force the de-registration with a Network Initiated De-Registration procedure. This procedure is initiated when the registration timer (set during the first registration procedure, and updated during re-registrations) in the S-CSCF expires. At this moment the S-CSCF informs the gateway, and the gateway performs the deregistration (messages 6 and 7 presented above).

## 7 Transport Level Interworking

In the “Transport level interworking” mode, PDUs at the SM-TL layer are exchanged between the two endpoints (i.e. the LTE terminal and the legacy terminal). In other words, the SMS protocol stack is put above the SIP layer as shown in figure 24.

Additional functionalities are required for realizing this [23204]:

- The gateway must communicate via IMS with the UE while also maintaining the format and functionalities of the legacy service.
- For each SMS it will retrieve and store the subscriber data (whether it belongs to IMS or legacy domain).
- Performs short message authorization and stores the corresponding data, similarly to the MSC/SGSM (since the operator can impose Operator Determined Barring settings, prohibiting the user from sending messages).

With transport level interworking, the PDUs at the SM-TL layers are transported in different and independent SIP MESSAGE messages. For instance, SMS-DELIVER is transported into a SIP MESSAGE and SMS-DELIVER-REPORT is transported into another SIP MESSAGE. There is a need to bind the second one to the first one. This is possible by use of some options of the SIP protocol and more precisely by the optional field In-Reply-To. Like every message, the first SIP MESSAGE includes a Call-ID (mandatory field), which uniquely identifies the message. The recipient stores the value and uses it to fill the In-Reply-To of the second SIP message (see figure 26 and 27).

The same type of binding mechanism between successive messages is used in the IP-SM-GW: the MT Correlation ID is a service element used when the HPLMN of the receiving MS is using an SMS Router or an IP-SM-GW. It is used to correlate a Forward Short Message operation to a previous Info Retrieval operation.

Note that the IMSI that uniquely identifies a UE could be used. However, the use of the MT Correlation ID enhances security because it is dynamically computed by the HSS. By analyzing the Correlation ID received in a Forward Short message operation, it can be easily checked from where the associated Info Retrieval operation originated, thus resulting in detection of "fake" and "spoofed" Short messages.

### 7.1 Successful Encapsulated Short Message Sent from LTE towards GSM

In the following section are presented in detail the messages exchanged by the different entities when sending an SMS from an IMS-LTE terminal towards a GSM terminal.

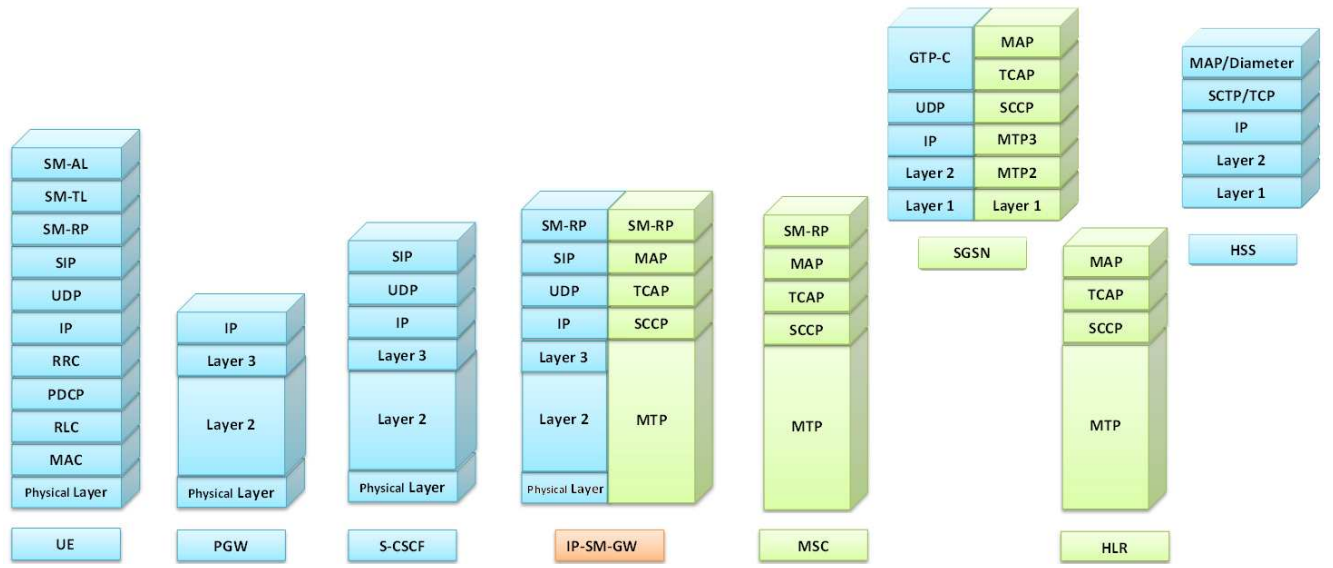

Figure 24. Transport level interworking - Protocol Stack

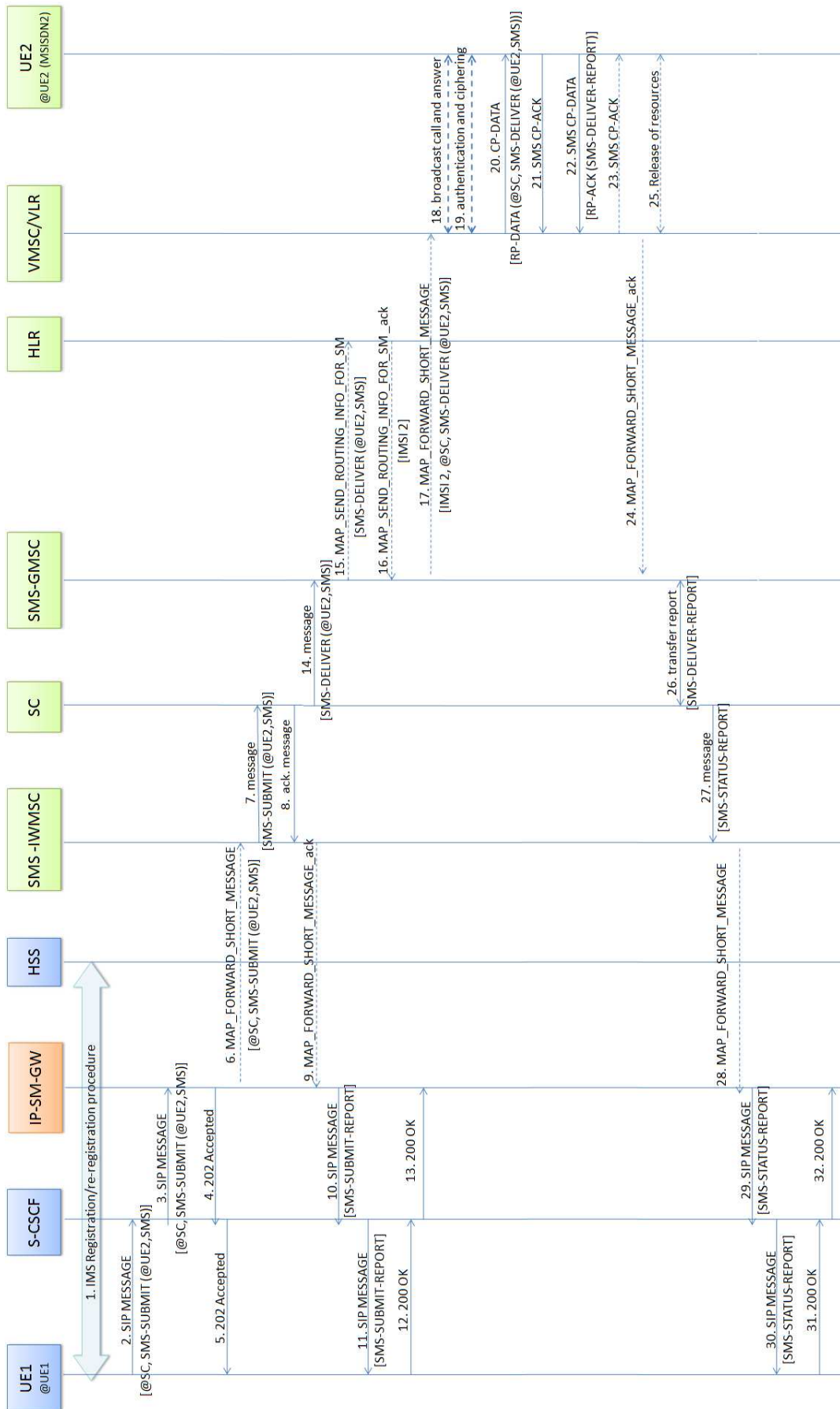

Figure 25. Successful encapsulated Short Message procedure from LTE to GSM

1. The UE registers to the S-CSCF, respecting the IMS Registration procedure.
2. The UE sends a SIP MESSAGE (containing an SMS SUBMIT and the SC Address) to the S-CSCF via SIP.
3. S-CSCF analyses the iFC<sup>1</sup> (Initial Filter Criteria) and forwards the received message to the IP-SM-GW.
4. – 5. The SIP MESSAGE is acknowledged by the IP-SM-GW and the S-CSCF. The UE receives the acknowledge message from the S-CSCF.
6. The IP-SM-GW performs service authorization (it checks if the UE is authorized to send SMSs and if it is authorized to use the encapsulated short message delivery via IMS).
  - a. If the UE is not authorized, the IP-SM-GW sends a failure report to the UE and does not forward the message.
  - b. Otherwise, it will de-encapsulate the SMS-SUBMIT message and forward it to the SMS-IWMSC via MAP.
7. -11. The SMS-IWMSC forwards the message to the SC, which replies with SMS-SUBMIT-REPORT. This report is forwarded from node to node until the UE. The IP-SM-GW will encapsulate it into a SIP request.
12. -13. The UE acknowledges the SIP request, which will be forwarded until the IP-SM-GW.
14. -26. The message is forwarded in GSM towards the second UE, as explained in chapter 3.5.2.
27. -32. The SC transforms the SMS-DELIVER-REPORT into an SMS-STATUS-REPORT and sends it encapsulated in a SIP message throughout the IMS towards the first UE (the sender).

## 7.2 Successful Encapsulated Short Message Sent from GSM to LTE

When a user located into a GSM network sends an SMS to an LTE subscriber, the network has to take several decisions based on the knowledge had about the destination of the SMS. The call flow generated when an encapsulated short message is successfully sent from GSM to LTE is represented in Figure 26.

---

<sup>1</sup>**Initial Filter Criteria** is performed when a message sent from LTE to GSM reaches the S-CSCF. If the user is subscribed to transport/service level interworking the message is forwarded to the IP-SM-GW. The gateway can recognize if the message it received is a

- Short Message – in which case it performs transport level interworking;
- Instant Message – in which case it:
  - sends the message over IMS if the destination is an IMS user,
  - sends it using service level interworking.

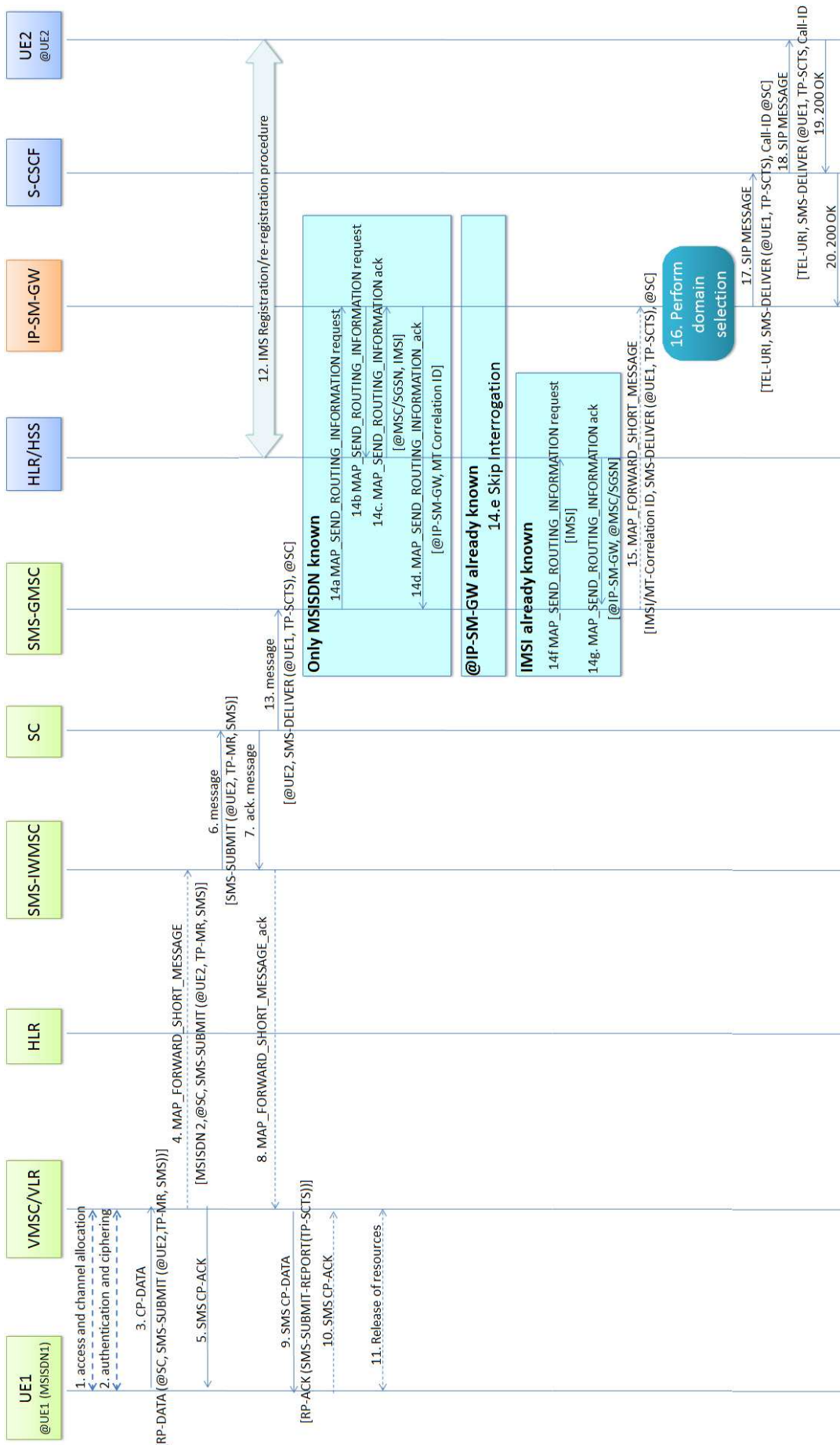

Figure 26. Successful encapsulated Short Message sent from GSM to LTE

1. -11. The message is originating in the GSM network, and is sent from the sender UE to the SC as explained in chapter 3.5.1
12. The UE registers to the S-CSCF respecting the IMS Registration procedure.
13. The SMS-SC forwards the short message (SMS-DELIVER) to the SMS-GMSC.
14. There are three possible situations:
  - i. The SMS-GMSC knows only the MSISDN, in which case:
    - 14a) The SMS-GMSC obtains the routing information by interrogating the HSS which forwards the request to the appropriate IP-SM-GW.
    - 14b) The HSS returns the addresses of the MSC/SGSN and the IMSI.
    - 14c) It creates the MT Correlation ID (see Annex 2), which may allow a correlation between this request for information and the following sent message. The IP-SM-GW returns to the SMS-GMSC its own address and the MT Correlation ID.
  - ii. 14d) The SMS-GMSC already knows the address of the corresponding IP-SM-GW (no other routing information needs to be demanded).
  - iii. The SMS-GMSC knows the IMSI of the UE2, in which case:
    - 14e) It sends a routing information message to the HSS.
    - 14f) The HSS answers with a message containing the address of the IP-SM-GW, and the address of the MSC and/or SGSN concerned.

Unless IMS is being used for transmission, the following steps will not be executed.

15. The SMS-GMSC delivers the Short Message (SMS-DELIVER) to the IP-SM-GW over MAP, together with:
  - i. MT Correlation ID (case 14i)
  - ii. IMSI (case 14iii)
16. The IP-SM-GW performs service authorization (it checks if the UE is authorized to send SMS and if it is authorized to use the encapsulated short message delivery via IMS). If the UE is not authorized, the IP-SM-GW sends a failure report to the UE and does not forward the message.
  - If there is no MSISDN, the IP-SM-GW does not need to perform domain selection, and it will send the message directly on IMS.
  - If the user has a MSISDN (and a MT Correlation ID is given in message 14c), the IP-SM-GW must perform domain selection<sup>2</sup>.
17. – 18. The IP-SM-GW forwards to the S-CSCF the message (SIP-DELIVER and SC address) encapsulated in SIP on IMS, transforming the IMSI into TEL URI. The S-CSCF sends it then to the user.
19. – 20. The UE sends a 200 OK message to the S-CSCF, and the latter forwards it to the IP-SM-GW.

When the SMS presented in Figure 26 arrives at the destination, it will be acknowledged with an SMS-DELIVER-REPORT as seen in Figure 27.

---

<sup>2</sup>**Domain Selection** is performed when the IP-SM-GW receives a message from GSM with a destination in LTE. If the UE has only legacy domain coverage, the message is forwarded on 2G/3G. If not, the message will be sent over IMS. Furthermore, the gateway must determine whether it has to perform transport level or service level interworking depending on the user's characteristics (capabilities, subscriptions, authorizations) and on the operator's policy.



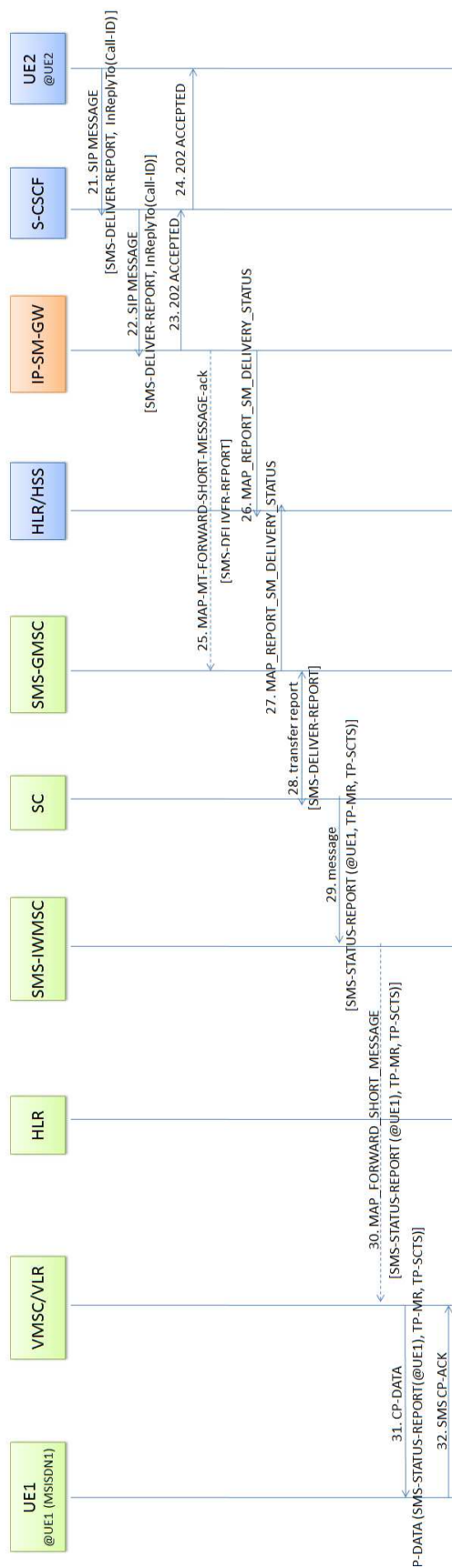

Figure 27. Delivery Report procedure (for a Short Message sent from GSM to LTE)

21. -22. The UE issues an SMS-DELIVER-REPORT to the S-CSCF. The latter forwards it to the correct IP-SM-GW (see 6.3.3.2, step 14c).
23. -24. The IP-SM-GW acknowledges the report with a 202 ACCEPTED SIP message sent to the S-CSCF. This one forwards it to the user.
25. The IP-SM-GW sends the SMS-DELIVER-REPORT to the SMS-GMSC.
26. The IP-SM-GW sends a Report Short Message Delivery Status to the HSS over MAP. This allows the HSS to update its Message Waiting Data File.
27. The SMS-GMSC sends a Report Short Message Delivery Status to the HSS over MAP, which the HSS will ignore.
28. The acknowledgment that the message was correctly received (SMS-DELIVER-REPORT) is forwarded to the SC.
29. -32 The SC transforms the message into an SMS-STATUS-REPORT and sends it over the GSM network until the UE.

On SIP level, the correlation between an SMS-DELIVER and an SMS-DELIVER-REPORT message is done differently than in GSM. Inside the SIP MESSAGE used to send an SMS-DELIVER there is a *Call-ID*, and the same Call-ID appears inside the SMS-DELIVER-REPORT in a field called *In Reply To* (see messages 17-22, Figures 26-27).

The SMS-STATUS-REPORT contains the TP-MR and the TP-SCTS making possible the correlation to the SMS-SUBMIT.

### 7.3 Unsuccessful Short Message Termination Procedure

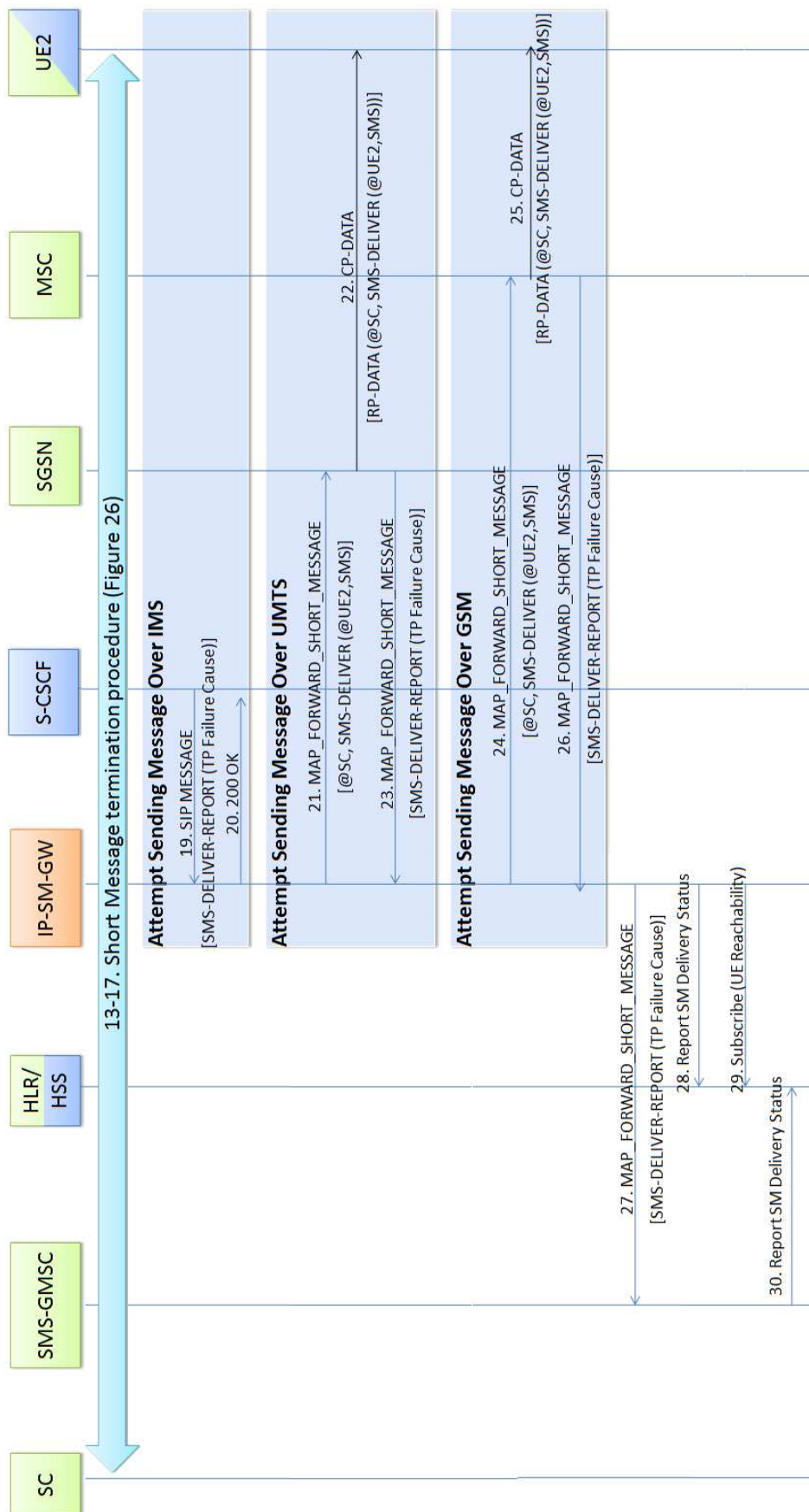

Figure 28. Unsuccessful Short Message termination procedure

In the situation presented in Figure 26, if the message cannot reach the destination UE, either because it is not present in the network or because its memory is currently full, then the network will generate the messages presented in Figure 28. The network will attempt to send the SMS over different domains taking into account the operator's policy and the user's preferences. In this scenario it was considered that firstly the message was sent over IMS, then over a Packet Switched domain, then over a Circuit Switched.

13. -17 The SC tries to deliver the message to the UE2, but does not receive an acknowledge message.
19. -20 The S-CSCF sends an error message to the IP-SM-GW containing the TP Failure Cause. The gateway acknowledges this message with a SIP 200 OK.
21. -23 The IP-SM-GW attempts to send the message over UMTS, so it sends it over MAP to the SGSN. The SGSN tries to deliver it to the UE2 and doesn't get an acknowledge message. Thus, the SGSN sends a MAP error message to the IP-SM-GW.
24. -26 The IP-SM-GW attempts to send the message over GSM, so it sends it over MAP to the MSC. The MSC tries to deliver it to the UE2 and, similarly to the previous cases, doesn't get an acknowledge message. Thus, the MSC sends a MAP error message to the IP-SM-GW.
27. The IP-SM-GW sends a MAP error message containing the SMS-DELIVER-REPORT to the SMS-GMSC.
28. Then, the gateway informs the HSS of all the errors occurred, sending it a Report SM Delivery Status over MAP. Consequently, the HSS updates its Message Waiting Data file.
29. In order to be able to send the message when the UE2 becomes available again, the gateway subscribes to the HSS for a one-time notification.
30. The SMS-GMSC will also send Report SM Delivery Status over MAP to the HSS, which the HSS will ignore.

## 7.4 Alerting the Service Centre when the Subscriber Becomes Available

Following the unsuccessful message termination due to the fact that the UE is not available, the HSS updates its Message Waiting Data, and must inform the SC as soon as the UE becomes available. This situation is presented below:

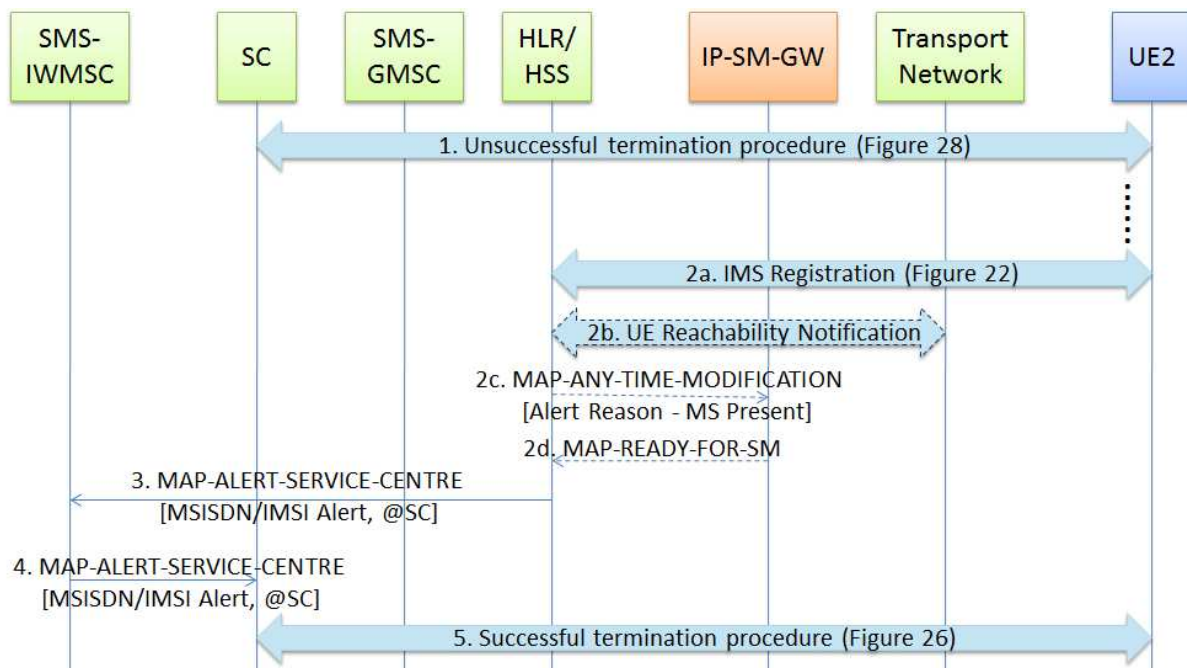
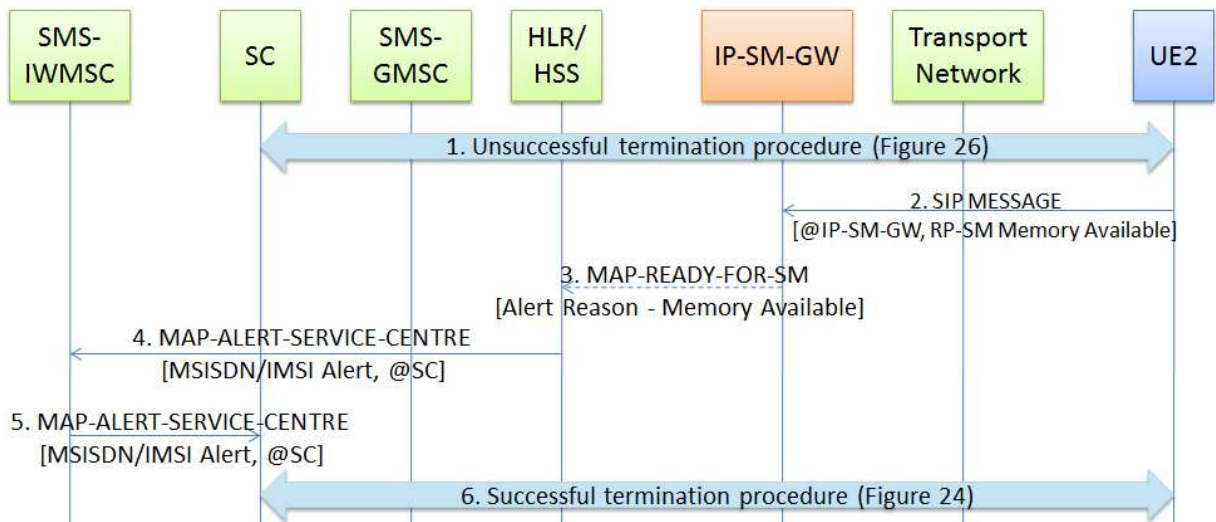

*Figure 29. Alert Service Centre procedure when UE becomes available*

1. The receiver is not available for receiving the message (chapter 7.3).
2.
  - a. The UE will become available as soon as it performs an IMS Registration procedure.
  - b. The transport layer informs the HSS that the UE is available.
  - c. If there are any messages waiting to be sent in the Message Waiting Data of the HSS, it informs the IP-SM-GW that the subscriber is available again, via MAP.
  - d. The IP-SM-GW informs the HSS that it can forward any waiting messages towards the UE via a *Ready* MAP message.
3. – 4. The HSS will inform the SMS-IWMSC that the subscriber with a given MSISDN or IMSI is now available for Short Message Transmission. The SMS-IWMSC forwards this message to the SC.
5. The SC sends the message to the UE.

## 7.5 Alerting the Service Centre when the Subscriber Has Memory

When the memory capacity of a UE allows the reception of a new SMS, the UE informs the IP-SM-GW. The notification is done via a SIP MESSAGE, which contains RM-SMMA (Relay Protocol – Short Message Memory Available). From here on, the procedure is similar to the previously presented one (chapter 7.4).



*Figure 30. Alerting the Service Centre when the subscriber has memory*

## 8 Service Level Interworking

According to [29311], the Service level interworking realizes the adaptation between an IM or Chat Session and the SM. The Service level interworking is a value added service. For the users to get access to it, they must have a subscription. Before allowing this interworking, the service authorization must be checked: the operator's policy and the Operator Determined Barring settings must be taken into account.

Additional functionalities are required for realizing this interworking function [23204].

- The IP-SM-GW must perform service authorization.
- The IP-SM-GW will analyze the types of messages, and realize the transformation if necessary.
- If an IM is transformed into a Short Message, the SCA must be added to the message.

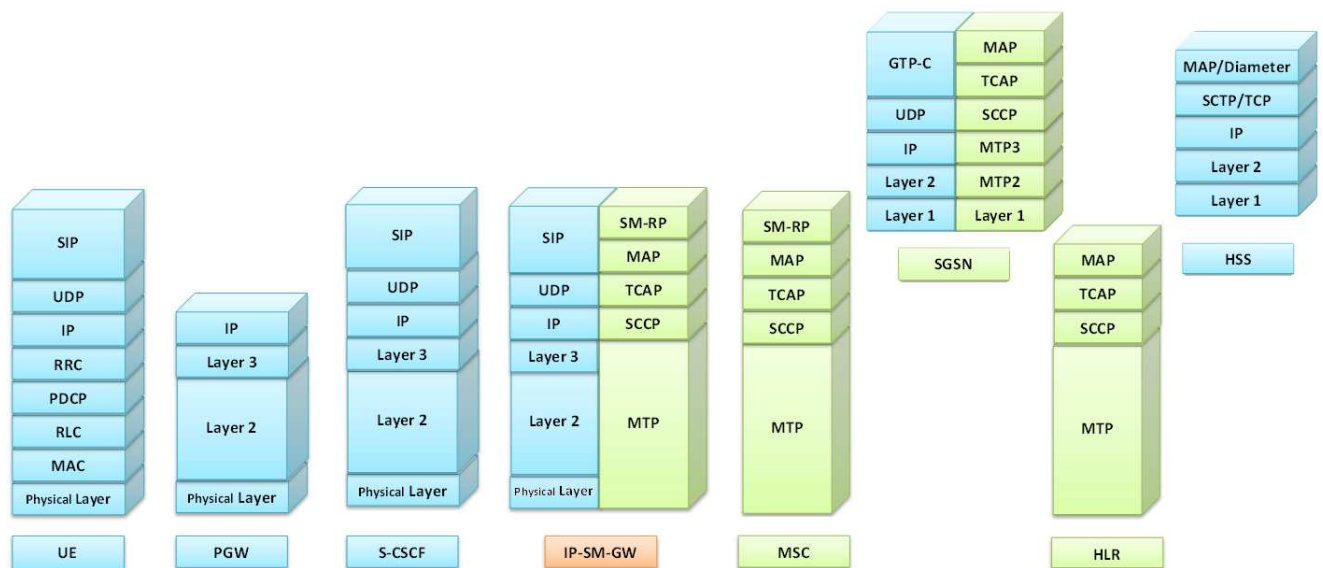

*Figure 31. Service level interworking - Protocol Stack*

### 8.1 UE Sends an Instant Message to an SMS User

As seen in Figure 31 presenting the protocol stack for the service level interworking, a pure LTE user is only capable to send SIP messages. In the case when UE sends an Instant Message, but the destination doesn't have the same IMS service, the IP-SM-GW has to perform a transformation from SIP to a MAP messages containing an SMS PDU, as seen in the call flow presented in Figure 32.

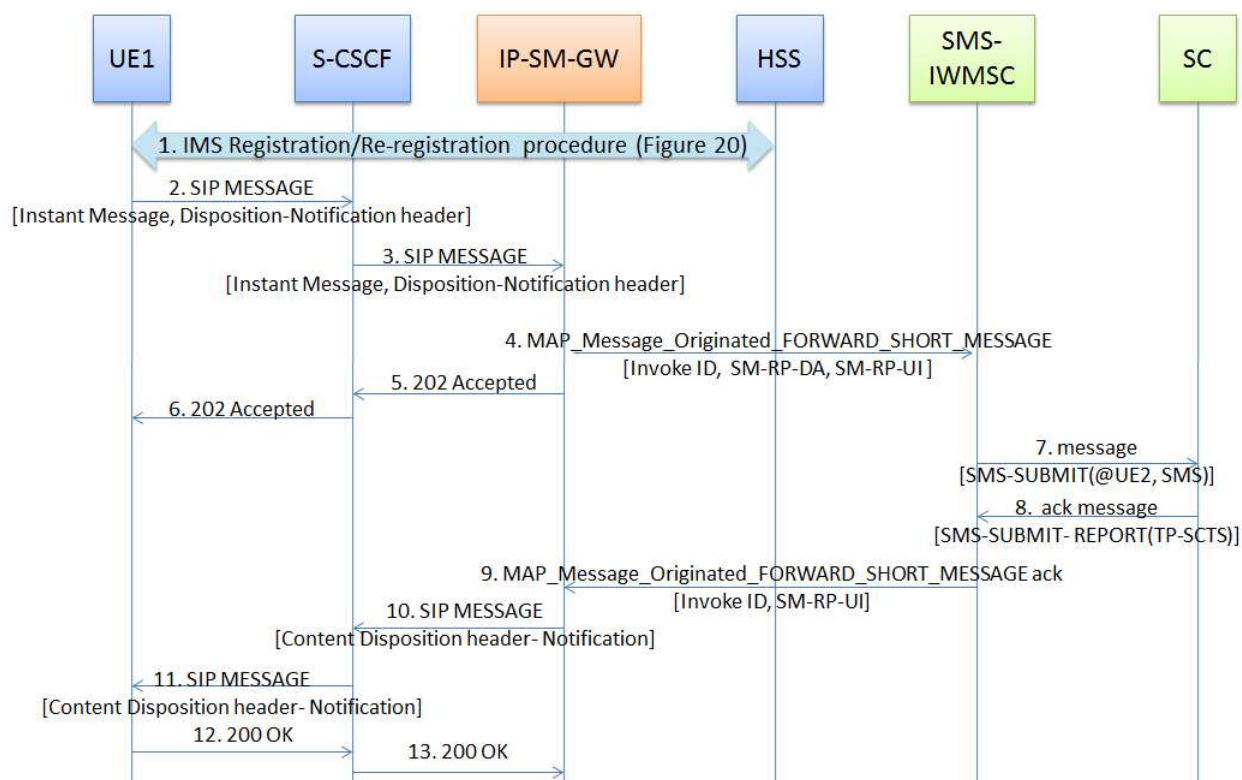

Figure 32. UE sends an Instant Message to an SMS user

1. The UE registers to the S-CSCF respecting the IMS Registration procedure.
2. The UE sends an IM containing to the S-CSCF via SIP (SIP MESSAGE). Inside this message the UE can choose to set a header called *Disposition Notification* which requests an *Instant Message Delivery Notification* (i.e. the UE is informed when the message was received).
3. S-CSCF analyses the iFC (Initial Filter Criteria) and forwards the received IM to the IP-SM-GW.
4. When the IM cannot be sent via IMS, the IP-SM-GW will consult the SIP-headers and the operator's policy in order to decide whether to perform service level interworking.
  - The IP-SM-GW realizes the service authorization. If the user does not have the authorization, then the gateway will not forward the message, and it will send back an error report.
  - If the user is authorized to use the service level interworking, the gateway transforms the SIP message into SMS-SUBMIT. This is forwarded to the SC via SMS-IWMSC. The MAP message used to send this SMS-SUBMIT contains the following elements:
    - *Invoke ID* – used to correlate two corresponding MAP messages.
    - *SM-RP-DA* – the destination address, in this case the Service Center Address.
    - *SM-RP-OA* – the originating address, in this case the MSISDN.
    - *SM-RP-UI* – the transport layer PDU of the SMS-SUBMIT.
  - If the IM is larger than 160 characters, the gateway will split it and send it as concatenated messages (see chapter 3.4).
5. – 6. The IP-SM-GW sends an acknowledge message to the S-CSCF. This one will forward the message to the UE.
7. The SMS-IWMSC sends the SMS-SUBMIT to the SC.



8. – 9. The SC responds to the SMS-IWMSC with an SMS-SUBMIT-REPORT. The SMS-IWMSC forwards it to the IP-SM-GW via a MAP message containing an *SM-RP-UI* with the value set to SMS-SUBMIT-REPORT.
10. – 11. The IP-SM-GW transforms the SMS-SUBMIT-REPORT into an IM and sends it to the S-CSCF. If the original IM needed to be split, now the IP-SM-GW waits for the last one of the reports and translates just this one into the appropriate IM and forwards it to the S-CSCF. The latter one will forward this message to the UE.
12. – 13. The UE acknowledges the IM to the S-CSCF which will forward it to the IP-SM-GW.

## 9 Conclusions

The SMS invention represented a very important step in the GSM world. Although it took a long time to become a widespread service, nowadays it represents a high percentage of the operators' revenues. For the user it is a very cheap and practical service, and the sender does not have to be preoccupied whether the receiver is available or not. For both participants it is a less intrusive way of communicating than voice calls.

With the constant improvement of mobile networks, the support of this successful legacy service is mandatory. In the last three years, most of the major operators in the world have started the deployment of LTE networks; some of them have actually started commercial operation. Since it is an all IP network, the key to maintaining the SMS service over LTE is the IP-Short Message-Gateway. This gateway is able to realize the interconnection between the 2G/3G network and LTE both on transport and service level.

The IP-SM-GW is involved in two scenarios. The first one is when a user from LTE that is capable of sending/receiving an SMS communicates to a GSM user and it results in a transport level interworking. The second scenario is when the same communication need arises, but the LTE user is unable to create or read SMSs resulting in service level interworking.

As far as the transport level interworking is concerned, in the case of a message being transmitted from LTE to GSM, the IP-SM-GW has to be able to interpret the SIP message that it receives, and also interpret the *Relay PDU*. It must look inside the message in order to recover the type of SMS PDU that it is sending. If a report is requested, the gateway must memorize the *Invoke ID* parameter.

If the message is being transmitted from GSM to LTE, the IP-SM-GW must interpret the SMS-PDU, fill in the necessary SIP headers and insert the *Relay PDU* in the SIP payload. The gateway shall store the *Call-ID* of the SIP session to verify the correct reception of the instant message.

When service level interworking is needed, in the case of an instant message being transmitted from LTE to GSM, the IP-SM-GW must translate the SIP headers in accordance to 3GPP 23.040 and set them inside the fields of the corresponding SMS PDU (see Annex 1). It will then take the payload of the SIP message and set it in the PDU as the TP-User-Data. If the sender requests an acknowledgement of reception of the message, it must store the *Message ID* header.

If the message is being transmitted from GSM to LTE, the IP-SM-GW will act similarly to the previous case. The complexity of the IP-SM-GW will be higher if it needs to support service level interworking due to the fact that upon the reception of a concatenated SMS, the gateway must store and acknowledge all the segments, except the last one. When the last one is received, it will unify them and forward them as an instant message. If a report is requested, the gateway must memorize the *Invoke ID* parameter.

The IP-SM-GW is an Application Server that acts as a bridge between the legacy domain and LTE, being able to convert an SMS message to a SIP one (or vice versa) in a manner that is fully transparent to the end user. It gives the operators the solution for protecting their investment in the 2G/3G network, by offering them the prospect to realize backwards compatibility. This increases the trust and acceptance of LTE, since it enables LTE subscribers to exchange messages with the broad number of legacy subscribers.

## Annex 1. SMS PDU in GSM – excerpt from 3GPP 23.040

### 9.2.2.1 SMS-DELIVER type

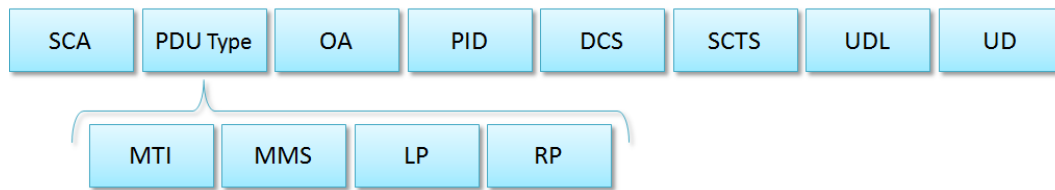

Figure 33. The PDU of an SMS DELIVER

Basic elements of the SMS-DELIVER type:

Abbr.	Reference	P1)	R2)	Description
TP-MTI	TP-Message-Type-Indicator	M	2b	Parameter describing the message type.
TP-MMS	TP-More-Messages-to-Send	M	b	Parameter indicating whether or not there are more messages to send
TP-LP	TP-Loop-Prevention	O	b	Parameter indicating that SMS applications should inhibit forwarding or automatic message generation that could cause infinite looping.
TP-RP	TP-Reply-Path	M	b	Parameter indicating that Reply Path exists.
TP-UDHI	TP-User-Data-Header-Indicator	O	b	Parameter indicating that the TP-UD field contains a Header
TP-SRI	TP-Status-Report-Indication	O	b	Parameter indicating if the SME has requested a status report.
TP-OA	TP-Originating-Address	M	2-12o	Address of the originating SME.
TP-PID	TP-Protocol-Identifier	M	o	Parameter identifying the above layer protocol, if any.
TP-DCS	TP-Data-Coding-Scheme	M	o	Parameter identifying the coding scheme within the TP-User-Data.
TP-SCTS	TP-Service-Centre-Time-Stamp	M	7o	Parameter identifying time when the SC received the message.
TP-UDL	TP-User-Data-Length	M	l	Parameter indicating the length of the TP-User-Data field to follow.
TP-UD	TP-User-Data	O	3)	

1) Provision; Mandatory (M) or Optional (O).

2) Representation; Integer (I), bit (b), 2 bits (2b), Octet (o), 7 octets (7o), 2-12 octets (2-12o).

3) Dependent on the TP-DCS.

#### 9.2.2.1a SMS-DELIVER-REPORT type

An SMS-DELIVER-REPORT TPDU is carried as an RP-User-Data element within an RP-ERROR PDU and is part of the negative acknowledgement to an SMS-DELIVER or SMS-STATUS-REPORT.

An SMS-DELIVER-REPORT TPDU is also carried as an RP-User-Data element within an RP-ACK PDU and is part of a positive acknowledgement to an SMS-DELIVER or SMS-STATUS REPORT.

#### (i) SMS-DELIVER-REPORT for RP-ERROR

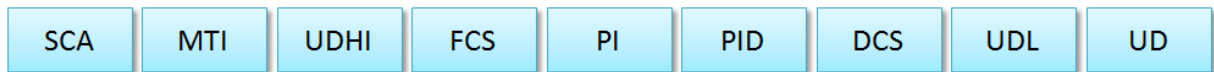

*Figure 34. The PDU of an SMS-DELIVER-REPORT for error*

Basic elements of the SMS-DELIVER-REPORT type:

Abbr.	Reference	p1)	p2)	Description
TP-MTI	TP-Message-Type-Indicator	M	2b	Parameter describing the message type
TP-UDHI	TP-User-Data-Header-Indication	O	b	Parameter indicating that the TP-UD field contains a Header
TP-FCS	TP-Failure-Cause	M	l	Parameter indicating the reason for SMS-DELIVER failure
TP-PI	TP-Parameter-Indicator	M	o	Parameter indicating the presence of any of the optional parameters which follow
TP-PID	TP-Protocol-Identifier	O	o	see clause 9.2.3.9
TP-DCS	TP-Data-Coding-Scheme	O	o	see clause 9.2.3.10
TP-UDL	TP-User-Data-Length	O	o	see clause 9.2.3.16
TP-UD	TP-User-Data	O	3) 4)	see clause 9.2.3.24

- 1) Provision: Mandatory (M) or Optional (O).
- 2) Representation: Integer (I), bit (b), 2bits (2b), octet (o).
- 3) Dependent upon the TP-DCS.
- 4) The TP-User-Data field in the SMS-DELIVER-REPORT is only available for use by the MT.

#### (ii) SMS-DELIVER-REPORT for RP-ACK

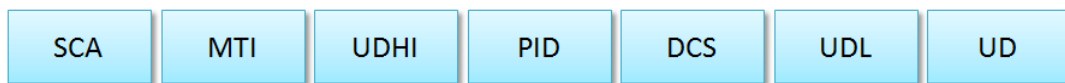

*Figure 35. The PDU of an SMS DELIVER-REPORT for Relay Protocol Acknowledge*

Basic elements of the SMS-DELIVER-REPORT type:

Abbr	Reference	P1)	P2)	Description
TP-MTI	TP-Message Type Indicator	M	2b	Parameter describing the message type
TP-UDHI	TP-User-Data-Header-Indication	O	b	Parameter indicating that the TP-UD field contains a Header
TP-PI	TP-Parameter-Indicator	M	o	Parameter indicating the presence of any of the optional parameters which follow
TP-PID	TP-Protocol-Identifier	O	o	see clause 9.2.3.9
TP-DCS	TP-Data-Coding-Scheme	O	o	see clause 9.2.3.10
TP-UDL	TP-User-Data-Length	O	o	see clause 9.2.3.16
TP-UD	TP-User-Data	O	3) 4)	see clause 9.2.3.24

- 1) Provision: Mandatory (M) or Optional (O).
- 2) Representation: Integer (I), Bit (b), 2 bits (2b), octet (o).
- 3) Dependent upon the TP-DCS.
- 4) The TP-User-Data field in the SMS-DELIVER-REPORT is only available for use by the MT.

### 9.2.2.2 SMS-SUBMIT type

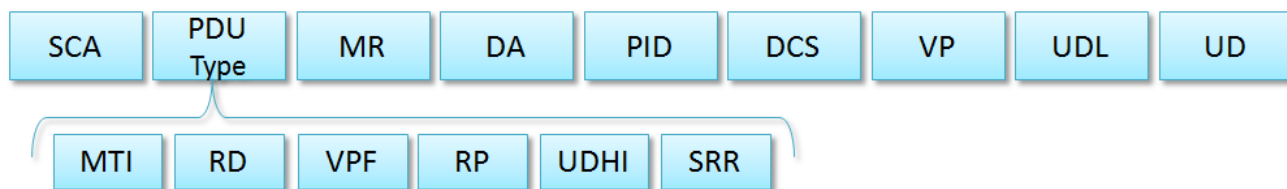

Figure 36. The PDU of an SMS-SUBMIT

Basic elements of the SMS-SUBMIT type:

Abbr.	Reference	p1)	p2)	Description
TP-MTI	TP-Message-Type-Indicator	M	2b	Parameter describing the message type.
TP-RD	TP-Reject-Duplicates	M	b	Parameter indicating whether or not the SC shall accept an SMS-SUBMIT for an SM still held in the SC which has the same TP-MR and the same TP-DA as a previously submitted SM from the same OA
TP-VPF	TP-Validity-Period-Format	M	2b	Parameter indicating whether or not the TP-VP field is present.
TP-RP	TP-Reply-Path	M	b	Parameter indicating the request for Reply Path.
TP-UDHI	TP-User-Data-Header-Indicator	O	b	Parameter indicating that the TP-UD field contains a Header.
TP-SRR	TP-Status-Report-Request	O	b	Parameter indicating if the MS is requesting a status report.
TP-MR	TP-Message-Reference	M	l	Parameter identifying the SMS-SUBMIT.
TP-DA	TP-Destination-Address	M	2-12o	Address of the destination SME.
TP-PID	TP-Protocol-Identifier	M	o	Parameter identifying the above layer protocol, if any.
TP-DCS	TP-Data-Coding-Scheme	M	o	Parameter identifying the coding scheme within the TP-User-Data.
TP-VP	TP-Validity-Period	O	o/7o	Parameter identifying the time from where the message is no longer valid.
TP-UDL	TP-User-Data-Length	M	l	Parameter indicating the length of the TP-User-Data field to follow.
TP-UD	TP-User-Data	O	3)	

- 1) Provision; Mandatory (M) or Optional (O).  
 2) Representation; Integer (l), bit (b), 2 bits (2b), Octet (o), 7 octets (7o), 2-12 octets (2-12o).  
 3) Dependent on the TP-DCS.

### 9.2.2.2a SMS-SUBMIT-REPORT type

An SMS-SUBMIT-REPORT TPDU is carried as an RP-User-Data element within an RP-ERROR PDU and is part of the negative acknowledgement to an SMS-SUBMIT or SMS-COMMAND.

An SMS-SUBMIT-REPORT TPDU is also carried as an RP-User-Data element with an RP-ACK PDU and is part of a positive acknowledgement to an SMS-SUBMIT or SMS-COMMAND.

#### (i) SMS-SUBMIT-REPORT for RP-ERROR



Figure 37. The PDU of an SMS-SUBMIT-REPORT for error

Basic elements of the SMS-SUBMIT-REPORT type:

Abbr.	Reference	p1)	p2)	Description
TP-MTI	TP-Message-Type-Indicator	M	2b	Parameter describing the message type
TP-UDHI	TP-User-Data-Header-Indication	O	b	Parameter indicating that the TP-UD field contains a Header
TP-FCS	TP-Failure-Cause	M	l	Parameter indicating the reason for SMS-SUBMIT failure
TP-PI	TP-Parameter-Indicator	M	o	Parameter indicating the presence of any of the optional parameters which follow
TP-SCTS	TP-Service-Centre-Time-Stamp	M	7o 5)	Parameter identifying the time when the SC received the SMS-SUBMIT See clause 9.2.3.11
TP-PID	TP-Protocol-Identifier	O	o	See clause 9.2.3.9
TP-DCS	TP-Data-Coding-Scheme	O	o	see clause 9.2.3.10
TP-UDL	TP-User-Data-Length	O	o	see clause 9.2.3.16
TP-UD	TP-User-Data	O	3) 4)	see clause 9.2.3.24

- 1) Provision: Mandatory (M) or Optional (O).
- 2) Representation: Integer (I), bit (b), 2bits (2b), octet (o).
- 3) Dependent upon the TP-DCS.
- 4) The TP-User-Data field in the SMS-SUBMIT-REPORT is only available for use by the SC.
- 5) This same time value shall also be carried in the SMS-STATUS-REPORT relating to a particular SM. See clause 9.2.2.3. This shall allow the submitting SME to associate a particular SMS-SUBMIT with a subsequent SMS-STATUS-REPORT by correlating the TP-SCTS values.

**(ii) SMS-SUBMIT-REPORT for RP-ACK**

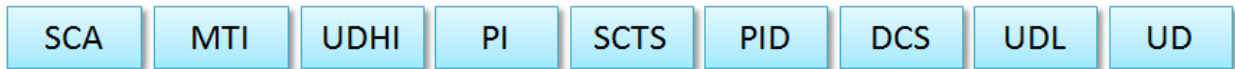

*Figure 38. The PDU of an SMS-SUBMIT-REPORT for acknowledge*

Basic elements of the SMS-SUBMIT\_REPORT type:

Abbr	Reference	p1)	p2)	Description
TP-MTI	TP-Message Type-Indicator	M	2b	Parameter describing the message type
TP-UDHI	TP-User-Data-Header-Indication	O	b	Parameter indicating that the TP-UD field contains a Header
TP-PI	TP-Parameter-Indicator	M	o	Parameter indicating the presence of any of the optional parameters which follow
TP-SCTS	TP-Service-Centre-Time-Stamp	M	7o 5)	Parameter identifying the time when the SC received the SMS-SUBMIT See clause 9.2.3.11
TP-PID	TP-Protocol-Identifier	O	o	See clause 9.2.3.9
TP-DCS	TP-Data-Coding-Scheme	O	o	see clause 9.2.3.10
TP-UDL	TP-User-Data-Length	O	o	see clause 9.2.3.16
TP-UD	TP-User-Data	O	3) 4)	see clause 9.2.3.24

- 1) Provision: Mandatory (M) or Optional (O).
- 2) Representation: Integer (I), Bit (B), 2bits (2b), octet (o).
- 3) Dependent upon the TP-DCS.
- 4) The TP-User-Data field in the SMS-SUBMIT-REPORT is only available for use by the SC.
- 5) This same time value shall also be carried in the SMS-STATUS-REPORT relating to a particular SM. See clause 9.2.2.3. This shall allow the submitting SME to associate a particular SMS-SUBMIT with a subsequent SMS-STATUS-REPORT by correlating the TP-SCTS values.

### 9.2.2.3 SMS-STATUS-REPORT type

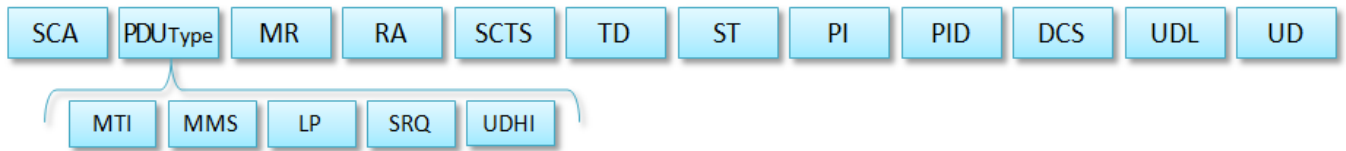

Figure 39. The PDU of an SMS-STATUS-REPORT

Basic elements of the SMS-STATUS-REPORT type:

Abbr.	Reference	p1)	R2)	Description
TP-MTI	TP-Message-Type-Indicator	M	2b	Parameter describing the message type
TP-UDHI	TP-User-Data-Header-Indication	O	b	Parameter indicating that the TP-UD field contains a Header
TP-MMS	TP-More-Messages-to-Send	M	b	Parameter indicating whether or not there are more messages to send
TP-LP	TP-Loop-Prevention	O	b	Parameter indicating that SMS applications should inhibit forwarding or automatic message generation that could cause infinite looping.
TP-SRQ	TP-Status-Report-Qualifier	M	b	Parameter indicating whether the previously submitted TPDU was an SMS-SUBMIT or an SMS-COMMAND
TP-MR	TP-Message-Reference <sup>3)</sup>	M	l	Parameter identifying the previously submitted SMS-SUBMIT or SMS-COMMAND
TP-RA	TP-Recipient-Address	M	2-12o	Address of the recipient of the previously submitted mobile originated short message
TP-SCTS	TP-Service-Centre-Time-Stamp	M	7o	Parameter identifying time when the SC received the previously sent SMS-SUBMIT
TP-DT	TP-Discharge-Time	M	7o	Parameter identifying the time associated with a particular TP-ST outcome
TP-ST	TP-Status	M	o	Parameter identifying the status of the previously sent mobile originated short message
TP-PI	TP-Parameter-Indicator	O	o	Parameter indicating the presence of any of the optional parameters which follow
TP-PID	TP-Protocol-Identifier	O	o	see clause 9.2.3.9. TP-PID of original SMS-SUBMIT
TP-DCS	TP-Data-Coding-Scheme	O	o	see clause 9.2.3.10
TP-UDL	TP-User-Data-Length	O	o	see clause 9.2.3.16
TP-UD	TP-User-Data	O	5)	see clause 9.2.3.24

- 1) Provision: Mandatory (M) or Optional (O).
- 2) Representation: Integer (I), bit (b), 2 bits (2b), Octet (o), 7 octets (7o), 2-12 octets (2-12o).
- 3) Where the SMS-STATUS-REPORT is the result of an SMS-COMMAND and the TP-Command-Type was an Enquiry, the TP-MR returned in the SMS-STATUS-REPORT shall be the TP-MN which was sent in the SMS-COMMAND (i.e. the TP-MR of the previously submitted SM to which the Enquiry refers).
- 4) Mandatory if any of the optional parameters following TP-PI is present, otherwise optional.
- 5) TP-UD contains information related to a SMS-DELIVER; can contain information transported in the TP-UD of SMS-DELIVER-REPORT, and information inserted by the SMSC. The length of the TP-UD field is limited and might not be long enough to fit information both from the original receiving terminal (as included into the SMS-DELIVER-REPORT) and information added by the SMSC. In these cases the former information has higher priority, and the latter shall be truncated.

## 9.2.2.4 SMS-COMMAND type

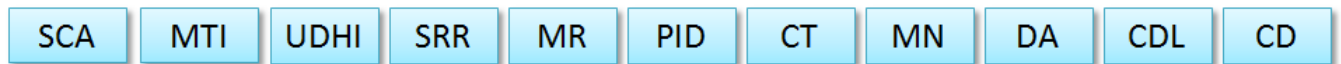

Figure 40. The PDU of an SMS COMMAND

Basic elements of the SMS-COMMAND type:

Abbr.	Reference	P1)	R2)	Description
TP-MTI	TP-Message-Type-Indicator	M	2b	Parameter describing the type
TP-UDHI	TP-User-Data-Header-Indication	O	b	Parameter indicating that the TP-CD field contains a Header
TP-SRR	TP-Status-Report- Request	O	b	Parameter indicating if the SMS Command is requesting a status report.
TP-MR	TP-Message Reference	M	I	Parameter identifying the SMS-COMMAND
TP-PID	TP-Protocol- Identifier	M	o	Parameter identifying the above layer protocol, if any
TP-CT	TP-Command-Type	M	o	Parameter specifying which operation is to be performed on a SM
TP-MN	TP-Message-Number	M <sup>3)</sup>	o	Parameter indicating which SM in the SC to operate on
TP-DA	TP-Destination-Address	M <sup>4)</sup>	2-12o	Parameter indicating the Destination Address to which the TP-Command refers
TP-CDL	TP-Command-Data-Length	M	o	Parameter indicating the length of the TP-CD field in octets
TP-CD	TP-Command-Data	O	o	Parameter containing user data

- 1) Provision: Mandatory (M) or Optional (O).
- 2) Representation: Integer (I), bit (b), 2bits (2b), octet (o).
- 3) For TP-Command-Types which are not for a specific SM this field shall be ignored when received. Its value is of no concern but the field must be present to maintain the structure.
- 4) For certain TP-Command-Types which operate on a specific SM (e.g. Enquire, Delete etc.) the full TP-DA must be specified. For TP-Command-Types which do not operate on a specific SM, the address length must be set to zero indicating that the Address-Value fields are not present. The Type-of-Address field must be present (see 9.1.2.5) and shall be set to zero and ignored.



## Annex 2. MT Correlation ID – excerpt from 3GPP 23.040

The MT Correlation ID is a service element used only when the HPLMN of the receiving MS is using an SMS Router or an IP-SM-GW. It is used to correlate a Forward Short Message operation to a previous Info Retrieval operation.

Use of the MT Correlation ID enhances security. By analyzing the Correlation ID received in a Forward Short message operation, it can be easily checked from where the associated Info Retrieval operation originated, thus resulting in detection of "fake" and "spoofed" SMSs.

The MT Correlation ID is used in place of the IMSI in the IMSI IE at the protocol layer. Hence, its structure is defined to be exactly the same as this element.

NOTE: Using an MT Correlation ID in place of the real IMSI has the added benefit of enhancing subscriber privacy in that the full IMSI is not shared with the HPLMN of the sending MS.

The MT Correlation ID shall be composed as shown in figure 3a below.

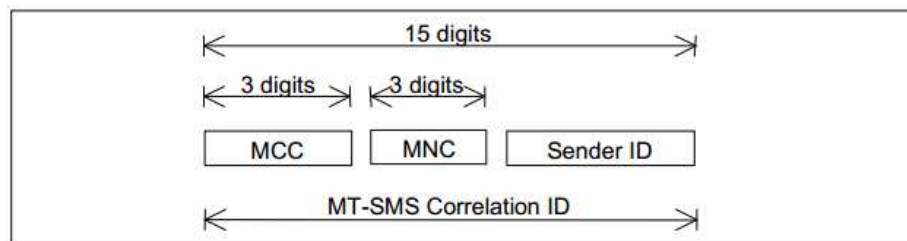

Figure 3a: Structure of the MT Correlation ID

The MT Correlation ID is composed of three parts:

1) Mobile Country Code (MCC) of the HPLMN of the receiving MS. It consists of three decimal digits.

2) Mobile Network Code (MNC) of the HPLMN of the receiving MS. It consists of three decimal digits. If the MNC of the HPLMN of the receiving MS is 2 digits only in length, the first digit of the MSIN shall be appended to the right-hand side.

3) Sender ID. It consists of nine decimal digits and shall be unique for its lifetime. For security purposes, its value shall be a number allocated at random, rather than sequentially.

An example of the MT Correlation ID is:

Sender ID: 569123006

IMSI in use: 234151234567890

Where:

MCC = 234;

MNC = 15;

MSIN = 1234567890, Which gives the MT Correlation ID: 234151569123006.

## Bibliography

- [23040] 3GPP TS 23.040 Technical Specification Group Core Network and Terminals; Technical realization of the Short Message Service (SMS), Release 11, V11.3.0 September 2012
- [23204] 3GPP TS 23.204 Support of Short Message Service (SMS) over generic 3GPP Internet Protocol (IP) access, Stage 2, Release 11 V11.2.0, June 2012
- [23401] 3GPP General Packet Radio Service (GPRS) enhancements for Evolved Universal Terrestrial Radio Access Network (E-UTRAN) access, Release 11, V11.4.0, December, 2012
- [23824] 3GPP TR 23.824 IP-Short-Message-Gateway (IP-SM-GW) enhancements for interworking with Open Mobile Alliance (OMA) Converged IP Messaging (CPM), Release 10, V10.0.0 March 2010
- [24247] 3GPP TS 24.247 Technical Specification Group Core Network and Terminals; Messaging service using the IP Multimedia Core Network subsystem; Stage 3, Release 11, V11.2.0 December 2012
- [3428] RFC 3428 Session Initiation Protocol (SIP) Extension for Instant Messaging; December 2002
- [36300] 3GPP Technical Specification Group Radio Access Network; Evolved Universal Terrestrial Radio Access (E-UTRA) and Evolved Universal Terrestrial Radio Access Network (E-UTRAN), Stage 2, (Release 11), V11.4.0, December 2012
- [4975] RFC 4975 The Message Session Relay Protocol (MSRP); September 2007
- [Bou12] Bouabdallah A.: Services pour réseaux d'opérateurs, Cours Télécom Bretagne, 2012
- [Bro07] Brown J., Shipman B., and Vetter R.: "SMS: The Short Message Service", Pages: 106-110, IEEE Journals & Magazines, 2007
- [Cam08] Camarillo G., Garcia-Martin M.: *The 3G IP Multimedia Subsystem (IMS), Merging the Internet and the Cellular Worlds*, John Wiley and Sons Ltd Publications, Third edition, 2008
- [End12] Endrowednes Kuantama, Leonardy Setyawan, Jessie Darma: "Early Flood Alerts Using Short Message Service (SMS)", International Conference on System Engineering and Technology (ICSET), Page(s): 1 - 5, 2012
- [Lag00] Lagrange X., Godlewski P., Tabbane S.: *Réseau GSM*, Hermes Science Publications, 5<sup>th</sup> edition, 2000
- [Lag12] Lagrange X., Nuaymi L.: *L'interface Radio et le Réseau d'Accès à LTE*, Formation Continue Télécom Bretagne, 2012
- [Lei10] Leitao F.A., Freire S.S., Lima S. R.: "SMS over LTE: Interoperability between Legacy and Next Generation Networks", Page(s): 634 – 639, IEEE Symposium on Computers and Communications (ISCC), 2010
- [Les08] Lescuyer P., Lucidarme T.: "Evolved Packet System (EPS), The LTE and SAE Evolution of 3G UMTS", John Wiley and Sons Ltd Publications, 2008

[Mia13] Miaojun, Xu; Jianke, Zhang; Xiaoqiu, Tan: “Intelligent Fish Disease Diagnostic System Based on SMS Platform”: Third International Conference on Intelligent System Design and Engineering Applications (ISDEA), Page(s): 897 - 900, 2013

[Mon13] Mondal, Prasenjit; Desai, Prashant; Ghosh, Soumya K.; Mukherjee, Jayanta: “An Efficient SMS-Based Framework for Public Health Surveillance”, Point-of-Care Healthcare Technologies (PHT), Page(s): 244 - 247, 2013

[Ses12] Sesia S., Toufil I., Baker M.: *LTE The UMTS Long Term Evolution – From theory to practice*, John Wiley & Sons, Ltd., 2012.

[Sum11] Sumra, I.A.; Hasbullah, H.; Manan, J.A.; Iftikhar, M.; Ahmad, I.; Alghamdi, A.S.: “A Novel Vehicular SMS System (VSS) Approach for Intelligent Transport System”, 11th International Conference on ITS Telecommunications (ITST), Page(s): 540 – 546, 2011

[Tro10] Trosby F., Holley K., Harris I.: *Short Message Service (SMS) – the creation of personal global text messaging*, A John Wiley and Sons, Ltd., Publication, 2010

[Zhu11] Zhuanwei Wang, Chunjiang Zhao, Haihui Zhang, Hongpan Fan: “Real-time Remote Monitoring and Warning System in General Agriculture Environment”, International Conference on Information Technology, Computer Engineering and Management Sciences (ICM), Page(s): 160 - 163, 2011

[1] CTIA (Page consulted: 20/11/2012)The Wireless Association: Consumer Data Traffic Increased 104 Percent According to CTIA-The Wireless Association® Semi-Annual Survey, [On line], URL Address: <http://www.ctia.org/media/press/body.cfm/prid/2216>

[2] Mobile Squared, (Page consulted: 05/12/2012). *The future of Rich Communications Suite*, [On line], URL Address: <http://www.mavenir.com/assets/files/WPRCSMS.pdf>

[3] Learn Telecom (Page consulted: 02/12/2012). *SMS in GSM Network*, [On line], URL Address: <http://learntelecom.com/telephony/gsm/sms-in-gsm-network> .

[4] GL Communications Inc. (Page consulted: 02.03.2013). *MAP Protocol Emulator*, [On line], URL Address: <http://www.gl.com/maps-map-emulator.html>

[5] LTE World, (Page consulted: 04/01/2013). *LTE Subscribers to Exceed 100 Million Globally in 2013*, [On line], URL Address: <http://lteworld.org/blog/lte-subscribers-exceed-100-million-globally-2013>

[6] Global mobile Suppliers Association, (Page consulted: 04/01/2013). *GSA confirms LTE in mainstream, 145 networks in commercial service*, [On line], URL Address: [http://www.gsacom.com/news/gsa\\_369.php](http://www.gsacom.com/news/gsa_369.php)

[7] Telecom Cloud, (Page consulted: 02.03.2013). *LTE Dimensioning*, [On line], URL Address: <http://www.telecom-cloud.net/basics-of-lte-dimensioning/>

## Acronyms

3GPP	Generation Partnership Project
AS	Application Server
BSS	Base Station System
CM	Connection Management
CN	Core Network
CP	Control Protocol
CS	Circuit Switched
CSCF	Call/Session Control Function
EMS	Enhanced Messaging Service
eNB	Evolved NodeB
EPC	Evolved Packet Core
EPS	Evolved Packet System
E-RAB	E-UTRAN Radio Access Bearer
E-UTRAN	Evolved UMTS Terrestrial Radio Access Network
GGSN	Gateway GPRS Support Node
GSM	Global System for Mobile Communications
HSS	Home Subscriber Server
iFC	Initial Filter Criteria
IM	Instant Message
IMPI	IP Multimedia Private Identity
IMPU	IP Multimedia Public Identity
IMS	IP Multimedia Subsystem
IMSI	International Mobile Subscriber Identity
IP-SM-GW	IP-Short Message-Gateway
ISDN	Integrated Services Digital Network
LAPDm	Link Access Protocol on the Dm Channel
LTE	Long Term Evolution
MAP	Mobile Application Part
MM	Mobility Management
MRFC	Multimedia Resource Function Controller
MRFP	Multimedia Resource Function Processor
MS	Mobile Station
MSC	Mobile Switching Centre
MSISDN	Mobile Station ISDN Number
MSRP	Message Session Relay Protocol

MTI	Message Type Indicator
MT-SMS	Mobile Terminating SMS
OTT	Over-The-Top
PDN	Packet Data Network
PDU	Packet Data Unit
P-GW	Packet Data Network Gateway
PLMN	Public Land Mobile Network
PSTN	Public Switched Telephone Network
QoS	Quality of Service
RNC	Radio Network Controller
RP	Relay Protocol
RR	Radio Resource
RTP	Real time Transport Protocol
SAE	System Architecture Evolution
SC	Service Center
SCA	Service Center Address
S-CSCF	Serving- Call/Session Control Function
SDP	Session Description Protocol
SGSN	Serving GPRS Support Node
S-GW	Serving Gateway
SIP	Session initiation Protocol
SM-AL	Short Message Application Layer
SME	Short Message Entity
SM-RL	Short Message Relay Layer
SM-RP	Short Message Relay Protocol
SM-RP-DA	SM-RP-Destination Address
SM-RP-OA	SM-RP-Originating Address
SMS	Short Message Service
SMS-GMSC	SMS Gateway MSC
SMS-IWMSC	SMS Interworking MSC
SM-TL	Short Message Transfer Layer
TCAP	Transaction Capabilities Application Part
TCP	Transmission Control Protocol
TL-PDU	Transfer Layer PDU
TPDU	Transfer Protocol Data Unit
TP-MR	Transfer Protocol Message Reference
TP-SCTS	Transfer Protocol Service Centre Time Stamp
TP-UDL	Transfer Protocol User Data Length

UAC	User Agent Client
UAS	User Agent Server
UDH	User Data Heather
UDHL	User Data Heather Length
UDP	User Datagram Protocol
UE	User Equipment
UMTS	Universal Mobile Telecommunication System
URI	Uniform Resource Identifier
VLR	Visitor Location Register
VMSC	Visiting MSC
VoIP	Voice over IP
WEME	Wireless Environment Monitoring Equipment

[www.telecom-bretagne.eu](http://www.telecom-bretagne.eu)

**Campus de Brest**

Technopôle Brest-Iroise  
CS 83818  
29238 Brest Cedex 3  
France  
Tél. : + 33 (0)2 29 00 11 11  
Fax : + 33 (0)2 29 00 10 00

**Campus de Rennes**

2, rue de la Châtaigneraie  
CS 17607  
35576 Cesson Sévigné Cedex  
France  
Tél. : + 33 (0)2 99 12 70 00  
Fax : + 33 (0)2 99 12 70 19

**Campus de Toulouse**

10, avenue Edouard Belin  
BP 44004  
31028 Toulouse Cedex 04  
France  
Tél. : +33 (0)5 61 33 83 65  
Fax : +33 (0)5 61 33 83 75

© Télécom Bretagne, 2013

Imprimé à Télécom Bretagne  
Dépôt légal : avril 2013  
ISSN : 1255-2275

