



**HAL**  
open science

## An experimental replica of the vocal folds to study normal and pathological voice

Xavier Pelorson, Xavier Laval

► **To cite this version:**

Xavier Pelorson, Xavier Laval. An experimental replica of the vocal folds to study normal and pathological voice. Acoustics 2012, Apr 2012, Nantes, France. pp.n/c. hal-00811143

**HAL Id: hal-00811143**

**<https://hal.science/hal-00811143>**

Submitted on 23 Apr 2012

**HAL** is a multi-disciplinary open access archive for the deposit and dissemination of scientific research documents, whether they are published or not. The documents may come from teaching and research institutions in France or abroad, or from public or private research centers.

L'archive ouverte pluridisciplinaire **HAL**, est destinée au dépôt et à la diffusion de documents scientifiques de niveau recherche, publiés ou non, émanant des établissements d'enseignement et de recherche français ou étrangers, des laboratoires publics ou privés.



# ACOUSTICS 2012

**An experimental replica of the vocal folds to study  
normal and pathological voice**

X. Pelorson and X. Laval

Grenoble Images Parole Signal Automatique, Gipsa-lab 961 rue de la Houille Blanche BP 46  
F - 38402 Grenoble Cedex  
[xavier.pelorson@gipsa-lab.grenoble-inp.fr](mailto:xavier.pelorson@gipsa-lab.grenoble-inp.fr)

In order to test the relevance and accuracy of theoretical models for speech production, validation on in-vitro controlled set-ups is needed. Since the pioneer work of Van Den Berg (1957) numerous mechanical replicas have been built in an increasing effort towards rendering the complexity of the human vocal folds. In this paper we present a new experimental set-up based on a replica of the vocal folds made of several successive layers of liquids and latex. Compared with existing mechanical models, this replica allows that essential parameters such as the degree of abduction, the acoustical loading, the upstream pressure and the elasticity of the replica can be controlled and varied individually. Further, pathological configurations, involving a local alteration of the vocal folds, such as polyps and cysts, can be easily simulated by adding growths of known masses and shapes. Typical examples of measurements performed on this replica will be presented for normal and pathological configurations.

## 1 Introduction

Voice pathology is extremely frequent and takes various forms, from brief perturbations to severe pathological diseases. As an example, the cases encountered by the teaching community are illuminating [1]. In France, a recent study from the Mutuelle Générale de l'Éducation Nationale (MGEN), reveals that 50% of female teachers and 26% of male teachers reported “often or always” voice troubles [2]. Economical impact is huge due to the short-term or long-term induced professional incapacity.

Physical modeling is intended to provide tools for analysis and diagnostic [3], for the prediction of surgery events or for the design of vocal folds prosthesis [4]. Numerous physical models have been proposed in the literature, focusing on the flow through the glottis, the elastic behavior of the vocal folds, the acoustical coupling with the vocal tract or both [5]. Since the goal of physical models is not only to explain the self-oscillations of the vocal folds but also to predict them, experimental validation is crucial. While numerical simulations can be an interesting tool for some specific aspects, they are limited by the complexity of the phenomenon involved. Mechanical replicas of the human larynx are widely used to test the relevance and the accuracy of physical theoretical models. The challenge of this experimental approach is 1) to mimic with a sufficient accuracy the human vocal folds (geometry, normal or abnormal behavior) and 2) to have a quantitative control of the different parameters (glottal area, subglottal pressure, elasticity).

In this paper, we present a mechanical replica of the larynx designed in order to study perturbations induced by some pathology (asymmetry, cysts, polyps ...). As it will be illustrated by some example, this replica has the advantage to allow for a control of each parameter independently.

## 2 Experimental replica

### 2.1 Set-up

The general experimental set-up is depicted on figure 1.

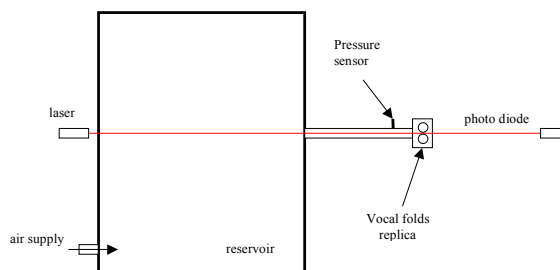

Figure 1: Schematic view of the experimental set-up.

It consists of a compressor connected to a large pressure reservoir filled with acoustical foam, in order to damp acoustical resonances. An up-scaled (by a factor 3:1) vocal tract replica is connected to the pressure reservoir using a 10 cm long uniform tube. An optical laser device passes through the reservoir and the vocal tract replica and the beam intensity is measured by a photodiode. After calibration, using slits of known geometry, this allows for a measurement of constrictions located inside the replica. Typical accuracy of these measurements are  $\pm 0.01$  mm. Pressure sensors (Kulite XCS093) are mounted along the pipe to measure the pressure at various places. Calibration of the pressure sensor is made again a water meter with an accuracy of  $\pm 5$  Pa.

### 2.2 Vocal folds replica

The vocal folds replica is presented on figure 2

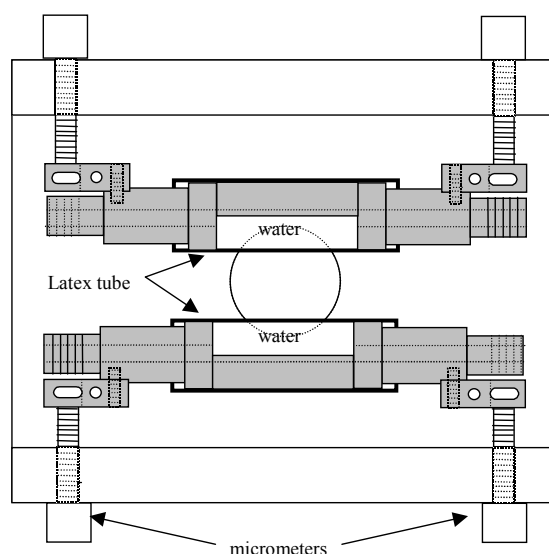

Figure 2: Front view (perpendicular to the airflow) of the vocal folds replica.

In its principle, this replica is comparable with the lips replica of Cullen et al. [6] or the vocal folds replica of Ruty et al. [7] as it consists of latex tubes filled with water under controllable pressure. A latex tube passes between each vocal folds replica and connects the upstream region to the downstream one, as shown on figure 3.

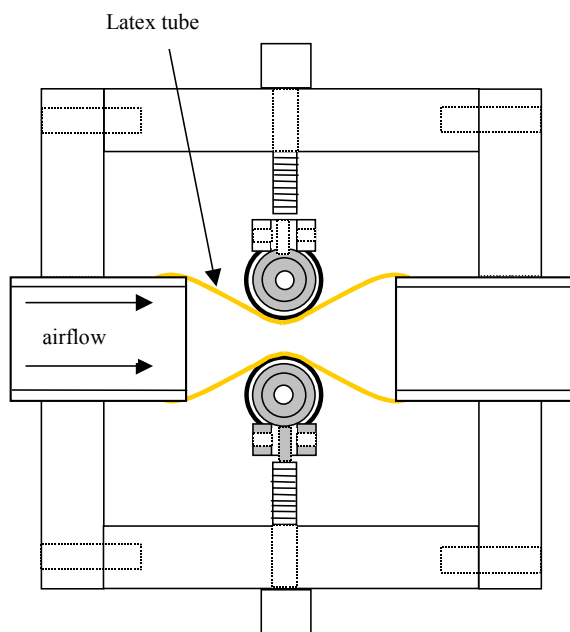

Figure 3: Side view (parallel to the airflow) of the vocal folds replica.

Four micrometer screws, located at each ends of the fold replica, allow for a precise control of the adduction (i.e. the aperture of the artificial glottis). Using the same device, various angles between the folds could be imposed from 0° (parallel folds, as depicted on figure 2) up to 20°.

### 3 Results

In the following we will present some examples of results obtained with the vocal folds replica. As relevant physical parameters we will focus on two quantities: the threshold pressure, defined as the minimum alimentation pressure needed to trigger self-sustained oscillations, and the corresponding fundamental frequency of oscillation. From both a production and a clinical point of view these quantities are of great interest since they correlate with, respectively, the ease of phonation and the pitch of the voice. Both onset and offset quantities are measured, the experimental derivation of these parameters is described in detail in Ruty et al. [7].

#### 3.1 Effect of vocal folds elasticity

In this experiment the pressure of water inside the vocal folds replica, and hence their elasticity, is changed while the aperture between the folds is kept constant by using the micrometer screws. Figure 4 presents a typical example of results.

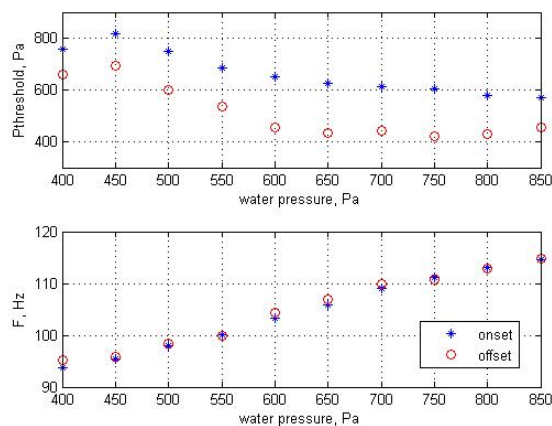

Figure 4: Top curve: onset and offset threshold pressure and bottom curve : corresponding fundamental frequency of oscillation as a function of the pressure of water inside the vocal folds replica. The initial aperture between the two folds is kept constant.

Figure 4 exhibits a typical behavior that has been reported from other experiments using different vocal folds mechanical replicas [7]. The fundamental frequency is a nearly linear function of the pressure of water inside the replica whereas the threshold pressure decreases rapidly. When larger water pressures are involved, the threshold pressure is found to increase again.

#### 3.2 Effect of vocal folds aperture

In this experiment, the pressure of water inside the vocal folds replica is kept constant at a value of 1060 cm of water while the initial aperture between the fold is increased up to 6 mm and then decreased (to test the repeatability of the measurements). An example of results is presented in Figure 5.

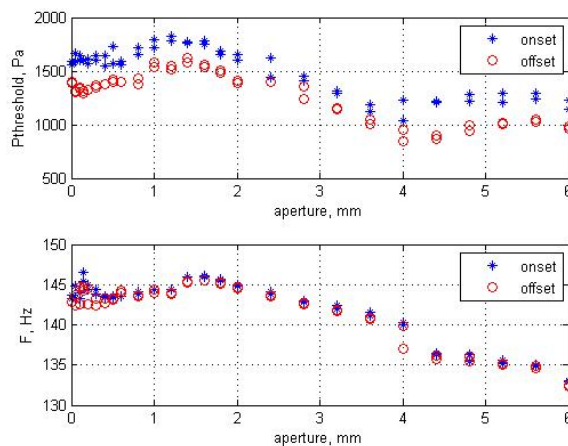

Figure 5: Top curve: onset and offset threshold pressure and bottom curve : corresponding fundamental frequency of oscillation as a function of the initial aperture between the two folds. The pressure of water inside the vocal folds replica is kept constant.

The effect of vocal folds aperture as a single parameter appears to have a considerable influence on the vibration thresholds.

### 3.3 Effect of glottal angle

As the ratio between the glottal aperture and the width of the vocal folds is small (of order of 0.1 for both human vocal folds and this mechanical replica), one generally assumes that the flow can be considered as two-dimensional through a parallel channel.

Even in non-pathological conditions, the human vocal folds are never completely parallel, the glottis having a “V” shaped aspect. The angle between the vocal folds can be estimated from medical imaging as to be of the order of a few degrees for normal voice, whereas in pathological cases it can exceed  $10^\circ$ .

To evaluate the importance of this parameter, in this experiment, the angle between the two mechanical folds is changed by acting on only one micrometer screw. An example of results is presented in Figure 6.

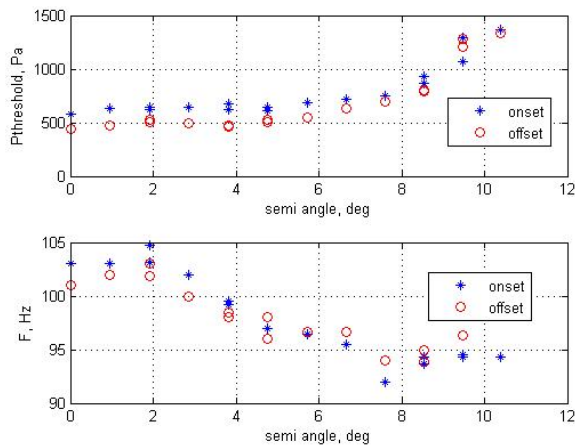

Figure 6: Top curve: onset and offset threshold pressure and bottom curve : corresponding fundamental frequency of oscillation as a function of angle between the two folds. The pressure of water inside the vocal folds replica is kept constant.

It can be observed that, as expected, for small angles (less than  $10^\circ$ ) both the threshold pressure and the fundamental frequency are very little affected. For larger values, however, an important increase of the threshold pressure together with a decrease of the fundamental frequency is clearly observed. These latter configurations would correspond to an abnormal glottal geometry.

### 3.4 Pathological configuration: mechanical asymmetry

In order to simulate the effect of a mechanical asymmetry, such as the one due to a (partial-) paralysis of a vocal fold, the pressure of water inside one fold is changed while the other one is kept constant. An example of results is presented in figure 7. The 0 left right pressure difference corresponds to mechanically symmetrical vocal folds replica

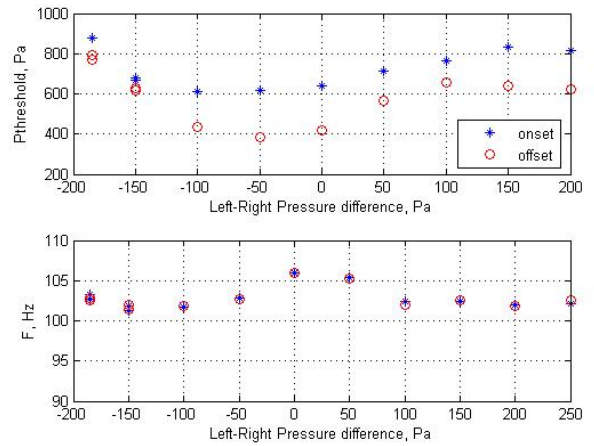

Figure 7: Top curve: onset and offset threshold pressure and bottom curve : corresponding fundamental frequency of oscillation as a function of the difference of water pressure inside the each vocal folds replica. The reference pressure is 605 mm H<sub>2</sub>O.

Since increasing or decreasing the pressure difference between the vocal folds replica affects the elasticity of one of the folds, figure 7 is to compare with the results of figure 4. Considering the threshold pressure, the global “U” shape behavior which is observed can therefore be attributed to the change of elasticity. However, compared with the mechanically symmetrical configuration, the increase of pressure threshold appears much more important in this case. Another important difference, with respect to the mechanically symmetrical configuration, occurs for the behavior of the Fundamental frequency. While decreasing the water pressure of one fold leads to a decrease of the fundamental frequency with a rate comparable to the mechanically symmetrical configuration, the same decrease is observed when increasing the water pressure.

### 3.5 Pathological configuration: presence of a growth

The presence of a growth on the vocal folds surface or internal to the vocal folds structure is a common pathological configuration. Cysts or polyps are typical examples of such configurations.

As a first attempt to experimentally simulate this kind of alteration, a cylinder of silicone (diameter 6 mm, height 2 mm) is glued on one vocal fold replica at 1/3 from its edge, as shown on the picture, figure 8.

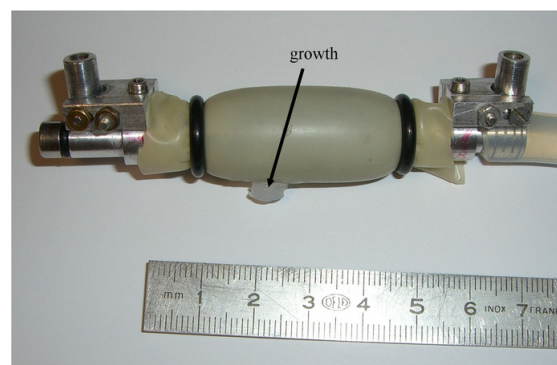

Figure 8: Picture of one vocal fold replica with artificial growth glued.



The presence of the connecting latex tube that covers the vocal folds replica, smoothens the glottal geometry as shown on figure 9. This point is of great importance as the glued silicone cylinder doesn't constitute an abrupt obstacle to the flow.



Figure 9: Picture of the glottal replica. Vocal fold with artificial growth is on the right side.

An example of results is presented on figure 10.

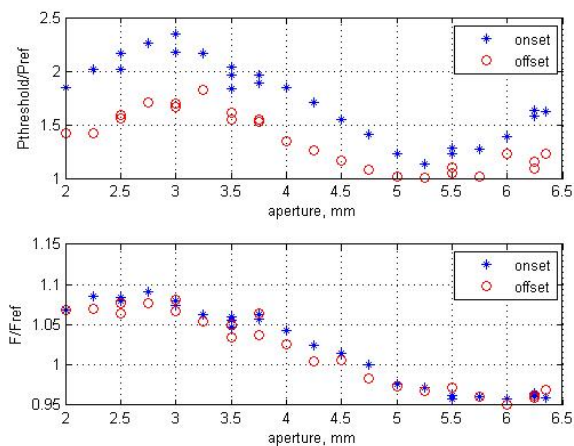

Figure 10: Top curve: onset and offset threshold pressure and bottom curve : corresponding fundamental frequency of oscillation as a function of the initial aperture between the two folds. Both quantities are normalized to the values obtained without the artificial growth. The pressure of water inside the vocal folds replica is kept constant.

The results presented in figure 10 are normalized to the measured values in the absence of the growth:  $P_{ref} = 780$  Pa and  $F_{ref} = 98$  Hz. Compared with the undisturbed case shown in figure 5, the global behavior of both the threshold pressure and the fundamental frequency appears quite similar. However the threshold pressure exhibits an spectacular increase by a factor up to 2 for small apertures which has the tendency to decrease as the aperture is

increasing. The perturbation in fundamental frequency is limited to  $\pm 5\%$ .

## 4 Conclusion

In this paper, we have presented a new vocal replica designed in order to account quantitatively for several parameters, individually or all-together. Some examples of results have been presented, and the potentiality of the replica illustrated, using pressure and frequency threshold measurements.

Ongoing research will be focused on more detailed analysis of the measured data. In particular, threshold measurements, although illustrative, do not account for chaotic behavior, frequency jumps that were observed experimentally, especially for the simulated pathological cases. In parallel, the analysis of these results will be made first from a physiological point of view, to correlate the observed phenomenon with clinical observations. Some behaviors, such as the effect of perturbations on the increase of the oscillation thresholds or on the lowering of the fundamental frequency seem already consistent with available literature. Others, like the evolution of the fundamental frequency in the presence of a growth or a mechanical asymmetry need to be validated by comparison with excised larynx experiments, for instance. Lastly, this experimental set-up will be used for the systematic validation of theoretical phonation models, testing different mechanical and flow theories.

## References

- [1] N. Roy, D. M. Bless, D. Heisey. "Personality and voice disorders: A superfactor trait analysis". *Journal of Speech, Language and Hearing Research*, 43, 749–768. (2000)
- [2] INSERM "La voix, ses troubles chez les enseignants", Éditions Inserm 2007, 343p (<http://lettremedecinsgeneralistes.inserm.fr/02/article-a-ctu-02.html>) (2007)
- [3] P. Mergell, Herzog, H. and Titze, I. R. "Irregular vocal-fold vibration - high-speed observation and modeling". *J. Acoust. Soc. Am.*, 108(8) :2996–3002. (2000)
- [4] M. De Vries, (2000). "A new voice for the voiceless. Design and in-vitro testing of a voice-producing element". PhD Thesis, University of Groningen. The Netherlands.
- [5] B. Fabre, Gilbert J., Hirschberg A., Pelorson X. "Aeroacoustics of Musical Instruments". *Annual Rev. Fluid Mech.* 44. 1-25. (2012)
- [6] J. Cullen, Gilbert J., Campbell D.M. "Brass instruments : linear stability analysis and experiments with an artificial mouth". *Acustica* 86 (2000), 704-724.
- [7] N. Ruty, Pelorson, X., Van Hirtum, A., Lopez, I., Hirschberg, A. "An in vitro setup to test the relevance and the accuracy of low-order vocal folds models". *Journal of the Acoustical Society of America*, 121, 479-490. (2007).