



HAL
open science

Simulation and measurement of loudspeaker nonlinearity with a broad-band noise excitation

Andrzej Dobrucki, Rafal Siczek

► **To cite this version:**

Andrzej Dobrucki, Rafal Siczek. Simulation and measurement of loudspeaker nonlinearity with a broad-band noise excitation. Acoustics 2012, Apr 2012, Nantes, France. hal-00811137

HAL Id: hal-00811137

<https://hal.science/hal-00811137>

Submitted on 23 Apr 2012

HAL is a multi-disciplinary open access archive for the deposit and dissemination of scientific research documents, whether they are published or not. The documents may come from teaching and research institutions in France or abroad, or from public or private research centers.

L'archive ouverte pluridisciplinaire **HAL**, est destinée au dépôt et à la diffusion de documents scientifiques de niveau recherche, publiés ou non, émanant des établissements d'enseignement et de recherche français ou étrangers, des laboratoires publics ou privés.



ACOUSTICS 2012

Simulation and measurement of loudspeaker nonlinearity with a broad-band noise excitation

A. Dobrucki and R. Siczek

Wroclaw University of Technology, Wybrzeze Wyspianskiego 27, 50-370 Wroclaw, Poland
andrzej.dobrucki@pwr.wroc.pl

In the paper the method of measurement of nonlinear distortion using broad-band signal as the excitation is presented. It consists in excitation of loudspeaker with an intensive broad-band noise with removed narrow frequency band using band-stop filter. The acoustic signal produced by the loudspeaker is filtered with a band-pass filter with the same bandwidth as previously removed. The content of signal in this frequency band is a measure of nonlinear distortion. The measurement can be realized in successive frequency bands in order to obtain the distortion as function of frequency. The very high steepness of slopes in band-stop and band-pass filters is required. The filters can be realized with a digital technology. Using Simulink® software the measurement of actual loudspeakers as well as simulations can be conducted. In the paper the influence of nonlinear parameters: stiffness of suspensions, force factor and inductance are presented and the results of measurements as well.

1 Introduction

Modern technology allows to perform multiple tests and measurements much more precise, easier and more accurately than it was several years ago. For example, signal processing is carried out almost exclusively in digital form. Also, the majority of acoustic measurements use digital technology. This article provides an overview of measurement and simulation of nonlinear distortion in loudspeaker and loudspeaker model using digital technology and broadband noise as a signal that stimulates [1][2]. Measurements and simulations have been carried out with the use of Matlab packages: Simulink and Filter Design & Analysis Tool. The block diagram of the measurement method is presented in Fig.1. The circuit is excited with white or pink noise.

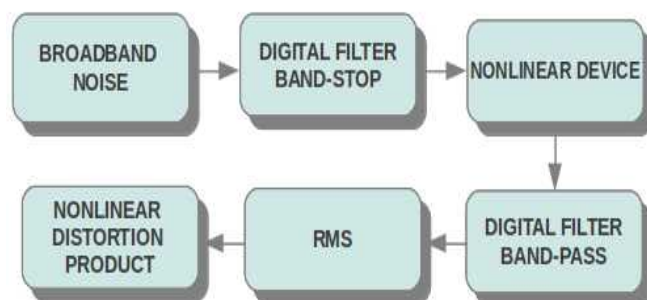

Figure 1: Measuring circuit

Digital filters used at the measurement have been designed so that the band-stop filter at the sending side of the system was of wider band than the band-pass one at the receiving side. This was connected with the necessity to eliminate the impact of the generated residual noise on the nonlinear distortion measurement results [1][2][3]. The residual noise is caused by finite slopes of both band-stop and band-pass filters. Apart of different bandwidth of both filters the high steepness of the slopes are required. In considered examples the band-pass filters have the bandwidth equal to 1/3-octave and band-stop filters have the bandwidth of rejection equal to 5/9-octave (1/9-octave has been added at left and right part of bandwidth of band-pass filters). The numerical experiments show that for a given slope of both filters the residual noise does not depend on central frequency of filters. E.g. for Butterworth responses of 15th order (slope 90 dB/oct) the residual noise for excitation with white noise is equal to -76.6 dB and for excitation with pink noise it is equal to -76.3 dB with respect to broad-band signal level. It allows for measurement and modelling of distortions above 0.001%.

Using the above system the simulations of nonlinear distortions in mathematical model of loudspeaker as well as measurements of an actual loudspeaker were performed.

2 Modeling of nonlinear distortions

2.1 Modeling of nonlinear distortion caused by force factor and suspension stiffness

The tested object is the model of loudspeaker with nonlinear force factor Bl and suspension stiffness K . Both quantities depend on displacement. The differential equation system has the form [1][4]:

$$E(t) = R_E i + Bl(x) \frac{dx}{dt} \quad (1)$$

$$M \frac{d^2 x}{dt^2} + R_M \frac{dx}{dt} + K(x)x = Bl(x)i$$

where E – electromotive force, t – time, x – displacement of the moving system, i – electric current, R_E – electrical voice coil resistance, M – mechanical mass of the moving system, R_M – mechanical resistance of the suspensions and:

$$\begin{aligned} K(x) &= K_0 [1 + \mu_2 (x - x_{02})^2] \\ Bl(x) &= Bl_0 [1 - \mu_1 (x - x_{01})^2] \end{aligned} \quad (2)$$

are suspension stiffness and force factor, respectively. Parameters μ_1 and μ_2 are called coefficients of nonlinearity and x_{01} and x_{02} are asymmetries of nonlinearities of Bl and K respectively.

The mathematical model of the dynamic loudspeaker described by equation system (1) is designed in the Simulink software as a flow-graph. The solution of the equation system (1) is displacement of the moving coil versus time. In order to obtain the acoustic pressure the following formula has been used:

$$p_{ak} = \rho_0 \frac{S}{2\pi d} \frac{d^2 x}{dt^2} \quad (3)$$

where: S – effective surface of the diaphragm, d – distance between loudspeaker and observation point ($d = 1$ m), ρ_0 – density of the air. The acoustic pressure level is computed

in each 1/3-octave bandwidth. It is a measure of nonlinear distortion. Figures 2 and 3 present dependence of nonlinear distortion level on coefficients of nonlinearity parameters μ_1 and μ_2 when the system is excited with white noise. It can be seen that with the increase of nonlinear parameters the level of distortions also increases.

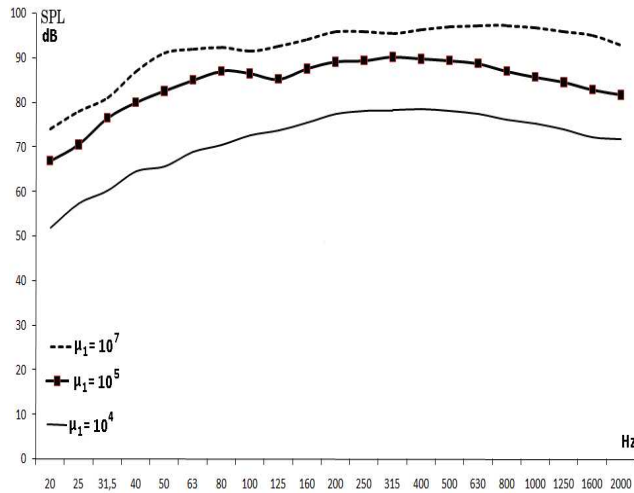

Figure 2: Nonlinear distortion level depending on the coefficient μ_1 for the excitation with white noise, $\mu_2 = 0$, $E=10V$.

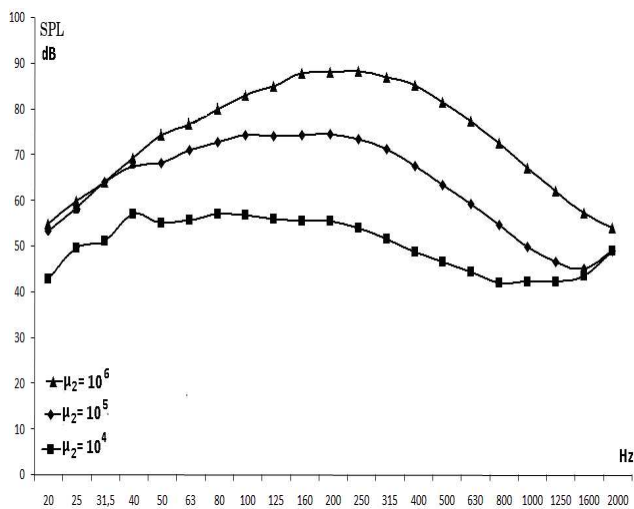

Figure 3: Nonlinear distortion level depending on the coefficient μ_2 for the excitation with white noise, $\mu_1 = 0$, $E=10V$.

2.2 Modeling of nonlinear distortion caused by nonlinear voice-coil inductance

In the equation system (1) the voice-coil inductance is neglected. The reason is that for low frequencies where the displacement levels and then the distortions are high the voice coil impedance is very low. If the linear work of the loudspeaker is analysed the inductance is usually neglected. However, for nonlinear model of loudspeaker the nonlinear voice coil inductance influences strongly the intermodulation distortion [4][5]. The voice coil inductance depends nonlinearly not only on displacement but also on electric current. The equation system has the form [4][5][6]:

$$L_{E0}(1 + Ax)(1 + 3bi^2) \frac{di}{dt} = E(t) - R_E i - Blv - L_{E0} A i v \quad (4)$$

$$\frac{dx}{dt} = v \quad (5)$$

$$\frac{dv}{dt} = -\frac{R_M}{M} v - \frac{K}{M} x + \frac{Bl}{M} i + \frac{L_{E0} A}{2M} i^2 \quad (6)$$

where:

$$L_E(x, i) = L_{E0}(1 + Ax)(1 + 3bi^2). \quad (7)$$

This mathematical model has been implemented in the Matlab/Simulink software as a flow-graphs shown below.

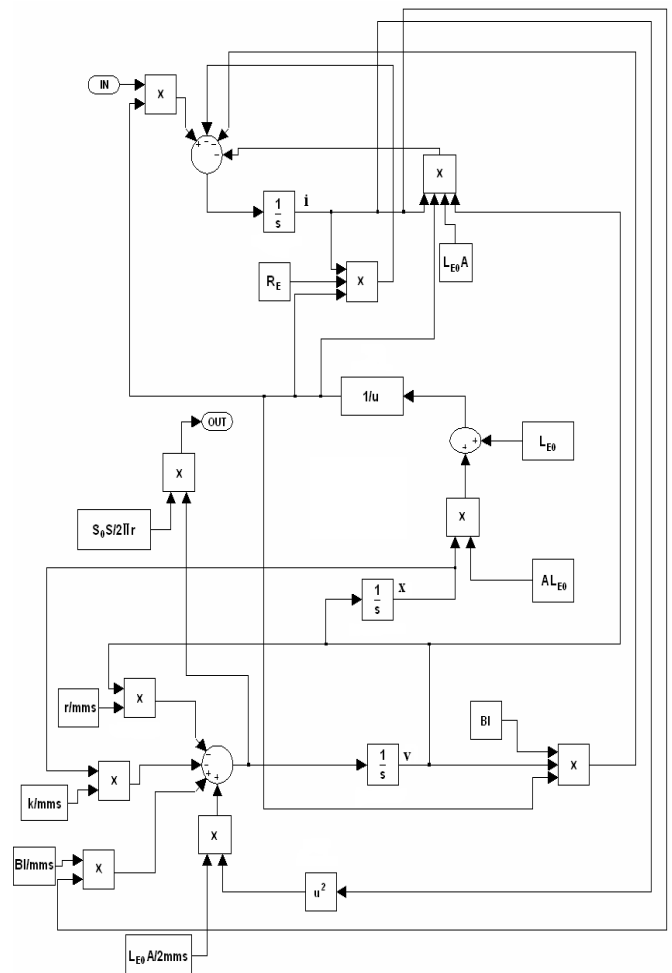

Figure 4: Flow chart – loudspeaker model – inductance depending on the displacement.

frequency bandwidth equal to 40 - 3000 Hz. Sounds were digitized using a PreSonus Firebox soundcard (44.1 kHz sampling rate, 24 bit depth). Recordings were filtered and analyzed using FDATool and Simulink program.

In Fig. 9 a schematic diagram of the applied method is presented. A narrow band is cut out from the broadband noise excitation by the use of a band-stop digital filter of high slope at the edges. This signal, after being enhanced, is sent to the loudspeaker. The signal received by the microphone will be put to an A/D converter with sampling rate of 44.1 kHz, and filtered by the band-pass digital filter. The signal obtained at the output of this filter is a nonlinear distortion product. It should be higher than the level of residual noise.

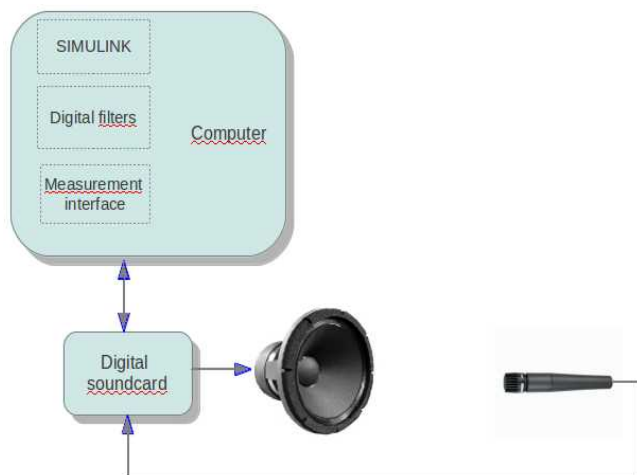

Figure 9: Measuring circuit with a an actual loudspeaker

The figures 10 and 11 present of loudspeaker nonlinear distortion versus input signal power when the system is excited with white and pink noise. Nonlinear distortion product is expressed in dB versus frequency.

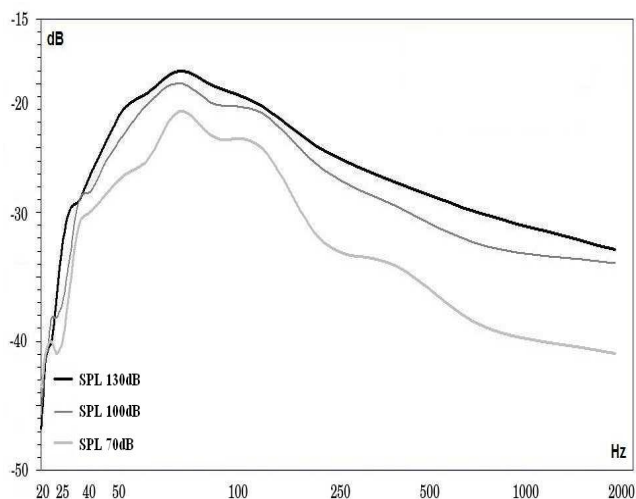

Figure 10: Nonlinear distortion level depending on frequency for white noise excitation. SPL of input signal is the parameter.

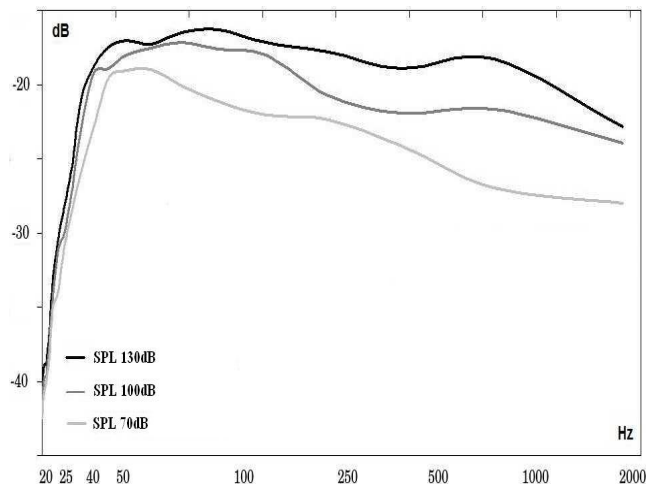

Figure 11: Nonlinear distortion level depending on frequency for pink noise excitation. SPL of input signal is the parameter.

It can be seen that with the increase of signal power the level of distortions increases, too. The obtained results show that the highest non-linear distortion level occurs at low frequencies of 30 up to 250 Hz range when exciting with white noise, and 20 up to 500 Hz at excitation with pink one. According to the expectations a higher distortion level can be observed when pink noise was used; this is caused by its spectral characteristics with the predominance of low frequencies. At the subjective perception the pink noise sounds much softly than the white one, and gives an impression of the filling of the sound band evenly.

5 Conclusion

The broad-band noise method of measurements of nonlinear distortions in loudspeakers using digital filters has been presented. The results of simulation of nonlinear distortion caused by force factor and suspension stiffness and results of nonlinear distortion caused by nonlinear voice-coil inductance are presented. It is possible to use a Simulink and FDATool programs to modeling and measurements a nonlinear distortion product in dynamic loudspeaker.

References

- [1] Siczek R., „Application of digital filters for measurement of nonlinear distortions in loudspeakers using Wolf’s method” ,Acoustics’08 Paris, June 29 – July 4, 2008r.
- [2] Siczek R., “Modeling and measurement of nonlinear distortion in loudspeakers using Simulink”. Forum Acousticum 2011, Aalborg, Danemark
- [3] Oppenheim A. V., Schafer R. W., Buck J. R., “Discrete-Time Signal Processing”, Prentice Hall, second edition, 1999r.

- [4] Dobrucki A., “*Electroacoustic Transducers*” (in Polish), WNT Warszawa 2007
- [5] A. Dobrucki, B.Merit, V.Lemarquand, G.Lemarquand *Modelling of the nonlinear distortion in electrodynamic loudspeakers caused by the voice-coil inductance*, 10^eme Congres Francais d’Acoustique 12-14.04.2010.
- [6] Dobrucki A., Siczek R., “*The measurement of nonlinear distortion using broadband noise*”, LV Open Seminar in Acoustics OSA2008r.