



HAL
open science

An optimization loop for aero-acoustics fan blade design

Claude Sensiau, Benoit Fayard, Jean-Michel Roux, Maxime Lebrun

► **To cite this version:**

Claude Sensiau, Benoit Fayard, Jean-Michel Roux, Maxime Lebrun. An optimization loop for aero-acoustics fan blade design. Acoustics 2012, Apr 2012, Nantes, France. hal-00811102

HAL Id: hal-00811102

<https://hal.science/hal-00811102>

Submitted on 23 Apr 2012

HAL is a multi-disciplinary open access archive for the deposit and dissemination of scientific research documents, whether they are published or not. The documents may come from teaching and research institutions in France or abroad, or from public or private research centers.

L'archive ouverte pluridisciplinaire **HAL**, est destinée au dépôt et à la diffusion de documents scientifiques de niveau recherche, publiés ou non, émanant des établissements d'enseignement et de recherche français ou étrangers, des laboratoires publics ou privés.



ACOUSTICS 2012

An optimization loop for aero-acoustics fan blade design

C. Sensiau, B. Fayard, J.-M. Roux and M. Lebrun

Snecma, Villaroche - Rond point R. Ravaud, 77550 Moissy-Cramayel, France
claude.sensiau@snecma.fr

In this paper is introduced, in a simplified way, a problem related to the fan blade design of an aircraft engine. The need of a compromise between performance criteria at high rating points and broad band noise at off-design points is emphasized. To minimize fuel consumption the fan design maximizes cruise efficiency, to reach environmental requirements, the fan blades have to be quiet (and thus efficient) during takeoff but also during landing at low power level. To deal with this kind of multi-disciplinary and multi-objectives problems, optimization methods are used. In this work, a simplified blade design is discussed and a special attention is paid to the fan mass flow rate and efficiency at high rotating speeds, as well as the interaction broad band noise at off-design points.

1 Introduction

Among the different modules of an aircraft engine, the fan module, including outlet guide vane (OGV) and inlet guide vane (IGV) is one of the main contributors to the overall engine noise. Indeed, over the last decades the increase in bypass ratio has drastically decreased jet noise and, as a consequence, other sources stand off, especially the fan. As environmental constraints grow [1, 2], Snecma focuses on its next generation fan design to fulfill increasingly challenging noise requirements.

Designing fan blades requires lots of different and complementary skills to conciliate all the aspects of the problem. Two of those fields are in the scope of this paper: acoustics and aerodynamics. A few words about the mechanical constraints must also be given but will not be included in the optimization process presented here.

- The acoustics constraints are given by the environmental restriction noise close to the airports and have to be respected for the certification process of the aircraft [1].
- A competitive engine is expected to deliver the thrust required with the lowest fuel consumption, to reduce exploitation costs and pollution.
- The engine must also satisfy all the safety criteria such as stress levels, bird ingestion, stability of the design to cyclic excitations...

Another important difficulty of the problem is that all those constraints have their own critical engine rating point.

- Acoustic restrictions are imposed during takeoff and landing, when the plane is close to the resident habitations.
- Aerodynamics and performance constraints are crucial around cruise ratings around cruise point, where the plane spends most of his time.
- Mechanical aspects are critical for very high rotating speeds such as the red line point, when the stress on the blade is maximum.

To sum this up, the problem is multi-physics and multi-objectives, and the best fan design must be a clever compromise to conciliate all those constraints. It leads to the need for engineers of optimization tools able to integrate all those different physics.

In this paper a simplified test case is presented to illustrate the difficulties arising with the conciliation of high rating engine performances and acoustic constraints at off design points.

2 The aero-acoustic constraints

In this section more details about aerodynamic, acoustic constraints and model used in the following are given. For the purpose of clarity and concision, the problem is simplified and only a few constraints and objectives of a real fan design are in the scope of this paper.

The aerodynamical constraints

- The fan efficiency, noted η_{cruise} , represents the ratio between power given by the fan to the air flow and power given to the fan. To minimize fuel burn, this quantity has to be maximized during the cruise of the plane where most of the time is spent considering a long range mission.
- The function of the fan is to suck enough air to produce the required thrust. The maximum required mass flow rate to allow takeoff in extreme conditions, called red line point, will be noted W_{RL} .

The acoustic constraint

For the certification process, three control points are specified [1]. One is during the approach phase at low RPM (Rotations Per Minutes), the others are during takeoff at higher ratings. The Effective Perceived Noise Level is calculated using a weighting process between tones, broad band noise and exposition time at those three control points. In the following we will focus on broad band noise at low RPM. Moreover, among all broad band noise mechanisms, the fan-OGV interaction is assumed to be the dominant one. It will be noted $FOBBIN_{app}$, standing for Fan-OGV Broad Band Interaction Noise at the approach control point.

A brief description of the FOBBIN model

The turbulence characteristics (turbulence kinetic energy and turbulence scales) are extracted from a RANS calculation in the wake of the fan blade. Assuming a Von Karman turbulence spectrum model impinging the OGV, an Amiet response function is used to compute $FOBBIN$ in far and free field under a flat plate approximation [3, 4, 5]. This is the simplest model to compute $FOBBIN$. It could be upgraded with duct effects and interaction effects occurring in a cascade of OGV [6]... but it turns out that those models are much more time consuming and not well suited for an optimization process. In this case the simplest model is chosen and suffices to illustrate the point of the paper. Moreover, another strong assumption is that only $FOBBIN$ is taken into account in this study. Indeed, it is currently a real challenge, to assess the breakdown of each noise mechanism and their relative importance. At each control

point the physics is different, and the assumed dominant mechanism might be reconsidered.

The mechanical aspects are not discussed here but it's important to keep in mind that this field has its own set of constraints.

3 The optimization process

Optimization methods are well suited to solve such a complex problem and are usually used by engineers [7, 8]. For this work a commercial software has been used [9]. Two steps in the optimization process are discussed in the following of the paper.

3.1 Step 1 : The Design of Experiments

This step has revealed very useful to identify the most influent parameters and their bounds. It is also very helpful to get physical interpretations of the behavior of the flow with parameters modifications. Finally, once the response function is sufficiently well resolved a mathematical optimization can be performed on the modeled surface response.

In this example the following four parameters have been chosen:

- The axial position of the center of gravity of the blade, noted x_g ,
- The tangential position of the center of gravity of the blade, noted y_g ,
- The stagger angle of the blade, noted α ,
- The chord of the profile.

Three control points are defined for each parameter at 30%; 60% and 90% of the blade height (see Figure 1), with a linear behavior between the control points. The hub and tip profiles are fixed.

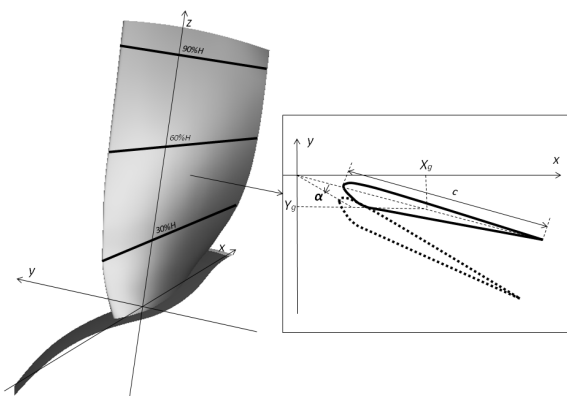

Figure 1: Design parameters and control points.

For this DoE a latin-hypercube technique has been used [8]. Around 100 experiments have been performed. The most CPU demanding step is the CFD RANS computation. It's a mono-sector calculation (see Figure 2), the mesh is approximatively 3 million nodes and takes about 1.5 hours to reach convergence. Finally, running such a DoE takes about 2 days on 8 quad-core processors NEHALEM 2.8 GHz.

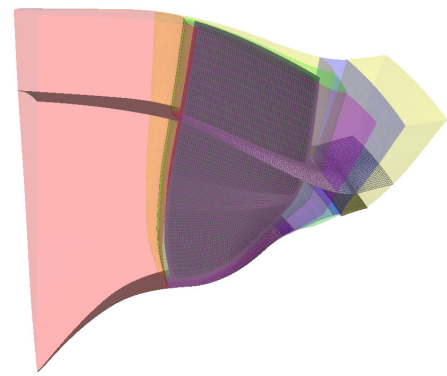

Figure 2: CFD RANS computational domain.

Low RPM results

In Figure 3 is shown the influence of each design parameters on $FOBBIN_{app}$. The stagger angle at 60% height, α_{60} , is clearly the most influent design parameter. In Figure 4 are plotted the experiments in a graph showing the evolution of the $FOBBIN_{app}$ with α_{60} . It can be seen that increasing α_{60} (ie "closing" the blade) of about 1° would decrease $FOBBIN_{app}$ of about 2dB.

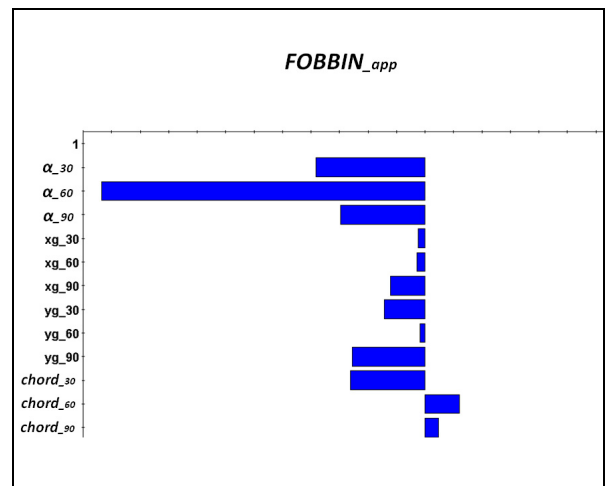

Figure 3: Relative influence of the design parameters on $FOBBIN_{app}$.

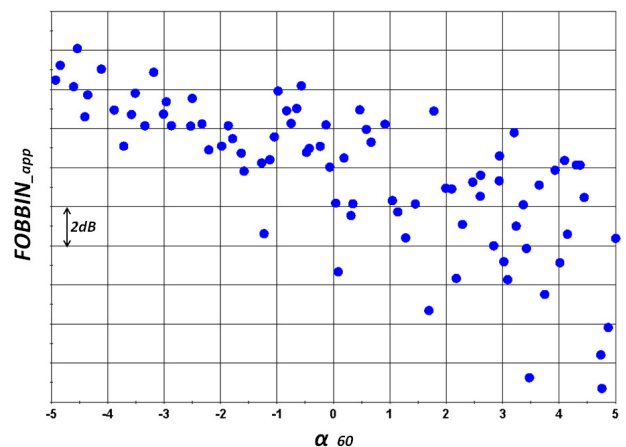

Figure 4: Evolution of $FOBBIN_{app}$ with the α_{60} .

One may wonder why modifying α_{60} of the fan blade has such a strong influence on the $FOBBIN_{app}$? Visualizing the flow around the fan blade revealed abnormally high kinetic turbulence energy levels at off design points and in particular at the approach control point. This high level kinetic energy pocket starts from the leading edge of the blade and induces high turbulence levels in the wake. This surplus of turbulence energy impinging the OGV is responsible for an increase of $FOBBIN_{app}$ according to the Amiet transfer function used in this acoustic model. An illustration of this mechanism is given in Figure 5.



Figure 5: Influence of angle α on the turbulence kinetic energy.

Focusing on low RPM results, it could be concluded that a change of angle α at 60% of the blade height is needed to reduce $FOBBIN_{app}$. Moreover, it is also interesting to notice that $FOBBIN_{app}$ and η_{app} are linked (see Figure 6). Adaptation of the blade profiles at the approach point is beneficial for both η_{app} and $FOBBIN_{app}$.

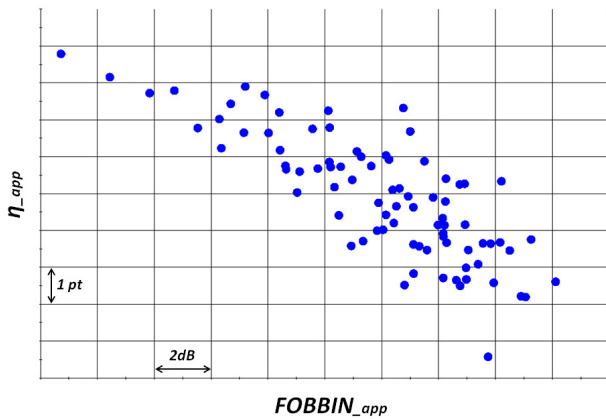

Figure 6: Evolution of the $FOBBIN_{app}$ with η_{app} .

High RPM results

In Figures 7 and 8 are shown the design parameters influences on the high RPM performance criteria, ie efficiency of the fan in cruise, η_{cruise} , and mass flow rate at red line point, W_{RL} . As it was observed for broad band noise at low RPM, the angle α in the upper part of the blade is the most influent design parameter. Unfortunately, as shown in Figure 9, the tendencies are opposite. Modifying the blade to decrease $FOBBIN_{app}$ would damage W_{RL} (1dB~1kg/s) and also η_{cruise} .

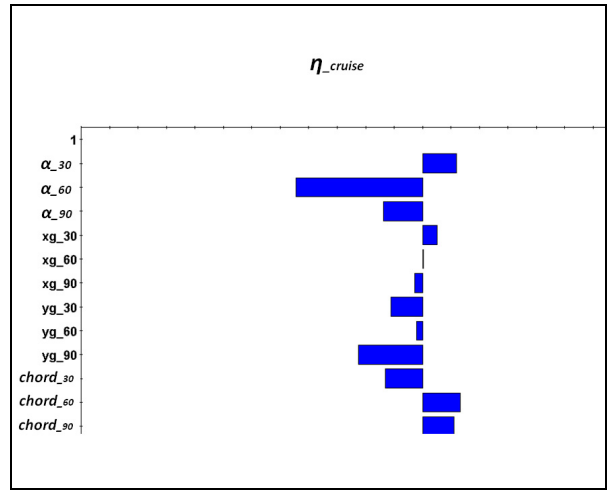

Figure 7: Relative influence of design parameters on the η_{cruise}

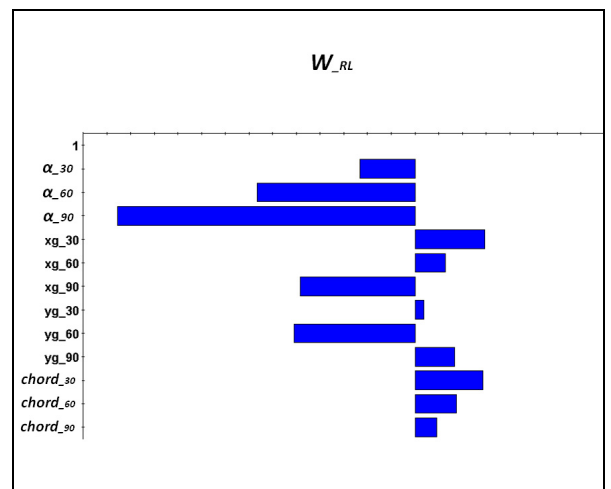

Figure 8: Relative influence of design parameters on the W_{RL} .

Indeed, the reference fan blade of the DoE was designed for a best efficiency at cruise. At off-design points the centrifugal stresses and the aerodynamic loading are modified and so is the shape of the blade. At approach control points, the profiles are not adapted in the 60% height region and this explains the presence of the high kinetic energy pockets. ‘‘Closing’’ the blade for better broad band noise results at low RPM would induce loss of high RPM performances.

From those results, the need of a compromise between broad band noise at off-design points and performance criteria at high RPM is clear.

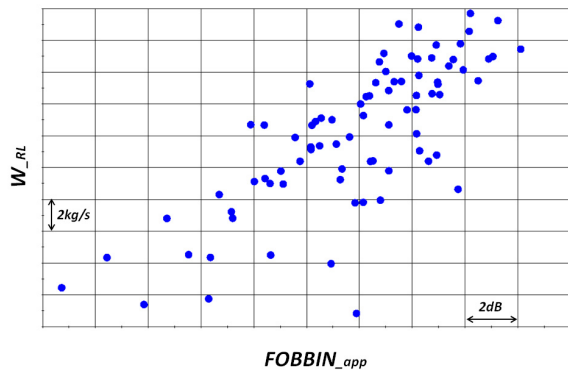

Figure 9: Evolution of the W_{RL} with the $FOBBIN_{app}$.

3.2 Step 2 : Optimizations

Three optimizations have been performed on the response surface model. The space design parameter is reduced to the angle α at 30%, 60% and 90% of blade height between -5° and 5° around the reference.

In Figures 10 to 14 are respectively performed minimization of $FOBBIN_{app}$, maximization of η_{cruise} and maximization of W_{RL} relaxed from other constraints. The optimization process is then free to choose angles to reach the extremum. This must be understood as a prospective study rather than a realistic optimization that would be used to produce a real fan blade design. Those results can be interpreted as the possible broad band and performance benefits if the twist modification of the blades due to centrifugal forces and aerodynamic loading was under control.

Optimization 1: minimization of $FOBBIN_{app}$ (Figures 10 and 11)

To minimize the $FOBBIN_{app}$, the blade has been closed, α_{60} and α_{90} are reaching their bounds ($\alpha = 5^\circ$). The direct consequences are losses of W_{RL} and η_{cruise} .

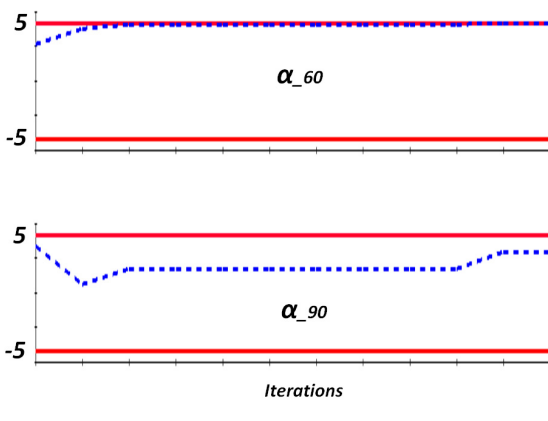

Figure 10: Optimization 1 – $FOBBIN_{app}$ minimization, evolution of the stagger angle.

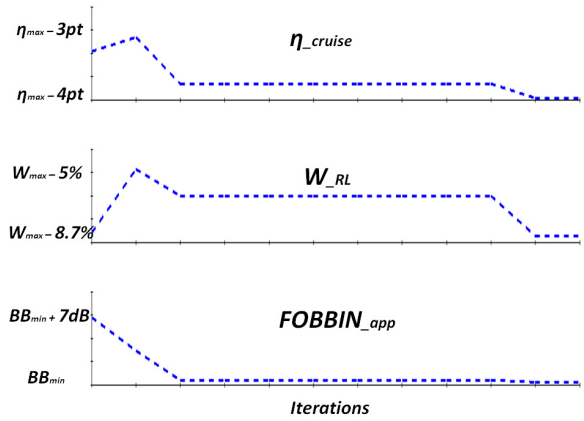

Figure 11: Optimization 1 - $FOBBIN_{app}$ minimization

Optimization 2: maximization of W_{RL} (Figures 12 and 13)

To maximize the W_{RL} the blade is opened, α_{60} and α_{90} are reaching the opposite bound ($\alpha = -5^\circ$). The $FOBBIN_{app}$ is increased during the process.

Note that the amplitude in broad band noise between optimizations 1 and 2 is around 15 to 20dB, emphasizing the huge potential in $FOBBIN_{app}$ gains if the twist of the blade was under control.

It is also interesting to note that η_{cruise} is decreased during the iteration process. It means that too high requirements in terms of mass flow rate would induce increased fuel burn.

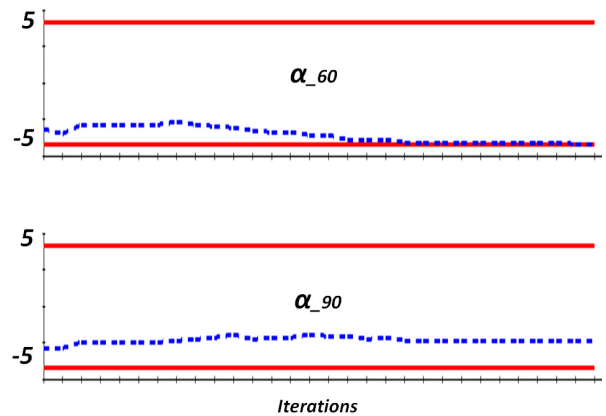

Figure 12: Optimization 2 - W_{RL} maximization, evolution of the stagger angle.

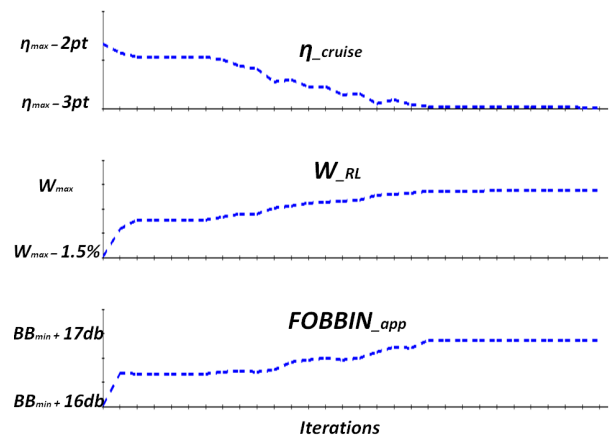

Figure 13: Optimization 2 - W_{RL} maximization

Optimization 3: maximization of η_{cruise} (Figures 14 and 15)

The maximization of η_{cruise} leads to an intermediate situation in terms of W_{RL} and $FOBBIN_{app}$. This is usually the quantity chosen to be optimized with the required red line mass flow rate and approach broad band noise level as constraints.

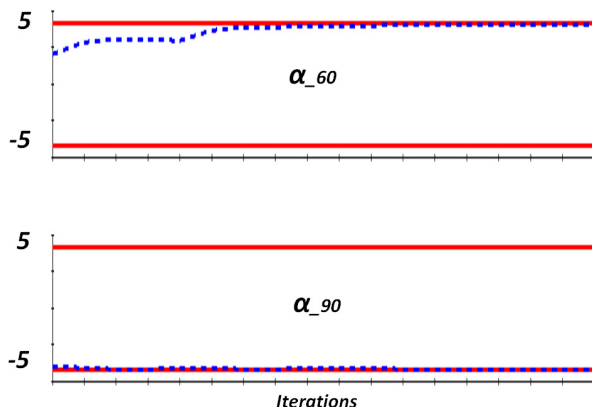

Figure 14: Optimization 3 - η_{cruise} maximization, evolution of the stagger angle.

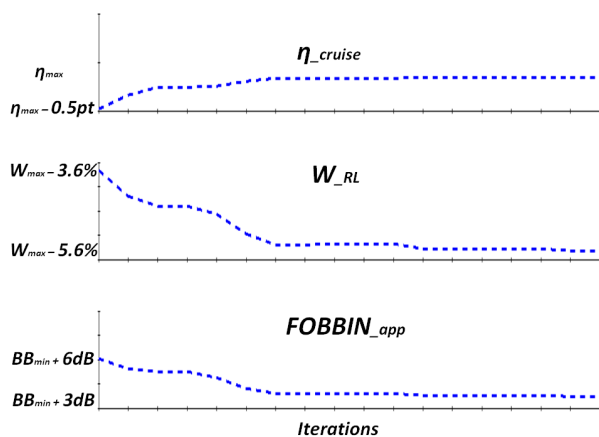

Figure 15: Optimization 3 - η_{cruise} maximization

4 Conclusions

In this paper was introduced in a simplified way, the multi-physics and multi-objectives problems faced by aircraft engine fan designers. An illustrative example of antagonist constraints has been given. To assess those kinds of problems engineers turn to optimization methods. The DoE step has revealed to be a useful tool to find the influent design parameters, define their bounds and have a physical comprehension of their influences. In this work the optimization step was used for a prospective study aiming at finding the bounds in terms of broad band noise and performance criteria reachable in an ideal case.

Another important message of this work is the need for the engineers to have simple models, easy to implement in optimization processes. Moreover, a current challenge is to quantify the breakdown of the different noise mechanisms:

fan self-noise, the fan-OGV/fan-IGV interaction noise, tip clearance noise etc. Their relative importance and their influence in the Effective Perceived Noise Level is the information needed to take into account the proper mechanism into the optimization process at the different engine ratings.

Acknowledgments

Those results were obtained in the framework of collaboration study with Cenaero.

References

- [1] International Civil Aviation Organization - Annex16 - Environmental Protection - Aircraft Noise - International Standards and Recommended Practices (2005)
- [2] Advisory Council for Aeronautics Research in Europe <http://www.acare4europe.com/html/documentation.asp>
- [3] R.K.Amiet, "Acoustic radiation from an airfoil in a turbulent stream", *Journal of Sound and Vibration* (1975)
- [4] B.D. Mugridge, "Broadband noise generation by aerofoils and axial flow fans", *AIAA Aero-Acoustics Conference* (1973)
- [5] S.W. Rienstra "Sound transmission in slowly varying circular and annular lined ducts with flow", *J. Fluid Mech*, vol. 380, pp.279-296 (1999)
- [6] H. Posson, M. Roger, "Fan-OGV Broadband Noise Prediction Using a Cascade Response", *15th AIAA Aero-Acoustics Conference* (2009)
- [7] D. Giacché, L. Xu, J. Coupland, "Multi-Disciplinary Multi-Objective Optimization of Bypass OGV for Low Interaction Noise", *AIAA Aero-Acoustics Conference* (2011)
- [8] A. Wilson, R. Stieger, J. Coupland, N. Smith, N. Humphreys, "Multi-Disciplinary Optimization of a transonic Fan for Low Tone Noise", *AIAA Aero-Acoustics Conference* (2011)
- [9] OPTIMUS – theoretical background – Noesis Solutions (2010)