



**HAL**  
open science

# Magnet-only loudspeaker motors: linear behavior theory vs. Nonlinear measurements

Antonin Novak, Benoît Merit

## ► To cite this version:

Antonin Novak, Benoît Merit. Magnet-only loudspeaker motors: linear behavior theory vs. Nonlinear measurements. Acoustics 2012, Apr 2012, Nantes, France. ⟨hal-00811093⟩

**HAL Id: hal-00811093**

**<https://hal.science/hal-00811093v1>**

Submitted on 23 Apr 2012

**HAL** is a multi-disciplinary open access archive for the deposit and dissemination of scientific research documents, whether they are published or not. The documents may come from teaching and research institutions in France or abroad, or from public or private research centers.

L'archive ouverte pluridisciplinaire **HAL**, est destinée au dépôt et à la diffusion de documents scientifiques de niveau recherche, publiés ou non, émanant des établissements d'enseignement et de recherche français ou étrangers, des laboratoires publics ou privés.



HAL Authorization



# ACOUSTICS 2012

## Magnet-only loudspeaker motors: linear behavior theory vs. Nonlinear measurements

A. Novak<sup>a</sup> and B. Merit<sup>b</sup>

<sup>a</sup>Laboratoire d'acoustique de l'université du Maine, Bât. IAM - UFR Sciences Avenue Olivier Messiaen 72085 Le Mans Cedex 9

<sup>b</sup>Orkidia Audio sarl, Estia 2, Technopole Izarbel, 64210 Bidart, France  
ant.novak@gmail.com

A few years ago, a new concept of magnet-only loudspeaker has been proposed to improve the quality of the reproduced sound. Such a loudspeaker is called magnet-only because its magnetic circuit is totally made of rare-earth permanent magnets. Unlike the classical electrodynamic loudspeaker, no iron is used. According to the theory, the exclusive use of permanent magnets and the absence of iron can lead to uniform motor parameters (force factor  $Bl$ , resistance  $R_e$  and inductance  $L_e$ ) over the voice-coil displacement and thus to a decrease of the nonlinear distortion and to an improvement of the sound quality. To our knowledge, such motor parameters have not been consistently quantified, neither their variations. In this paper, the variation of the parameters of a magnet-only loudspeaker are measured. The goal is to verify the theory and to show that using a simple measurement procedure one can understand better why a magnet-only loudspeaker improves the quality of the reproduced sound.

## 1 Introduction

A new concept of *magnet-only loudspeaker*, proposed few years ago, eliminates some of the non-linearities of the loudspeaker. The term *magnet-only* depicts a magnetic circuit totally made of rare-earth permanent magnets, such as  $NdFeB$  magnets. The elimination of iron from transducer motors is first presented in patent [1] and next can be found in [2, 3, 4, 5]. More recently, Remy [6] presented loudspeaker distortion reduction using bonded magnet-only motors. Advantages of such ironless structures have been shortly highlighted in [7] and [8]. Particularly, analytical studies [8, 9, 10] have shown that magnet-only magnetic circuits can lead to constant motor parameters (i.e. constant electrical resistance  $R_e$ , electrical inductance  $L_e$  and force factor  $Bl$ ).

To our knowledge, parameters of such magnet-only motor have not yet been consistently quantified, neither their variations. In this paper the motor parameters of two different loudspeakers are measured: an electrodynamic middle-cost loudspeaker and a prototype of a magnet-only loudspeaker developed in collaboration between Orkidia Audio S.A.R.L and Université du Maine. More details about the prototype of this magnet-only loudspeaker under test can be found in [11]. The aim of this paper is to show experimentally the impact of the use of magnet-only circuit on the behavior of motor parameters.

## 2 Motor Parameters

A classical approach to describe the motor parameters consists on the Thiele-Small [12] model, based on lumped parameters and linear behavior assumptions. In this model, the electromechanical coupling equation can be written in time-domain as

$$u(t) = R_e i(t) + L_e \frac{di(t)}{dt} + Bl \frac{dz(t)}{dt}, \quad (1)$$

where  $u(t)$  is the voltage across the voice-coil,  $i(t)$  is the current through the voice-coil and  $z(t)$  is the voice-coil displacement.

Nevertheless, the electrodynamic loudspeaker is known to be a nonlinear device [13]. Assuming constant parameters  $Bl$ ,  $R_e$  and  $L_e$  in Eq. 1 may cause a significant error in their estimation. The force factor  $Bl$  is usually the main source of distortion in low frequencies, where the voice-coil exhibits a large excursion. The variations of the force factor  $Bl$  are usually supposed to be due to the displacement variation only. Its variation with

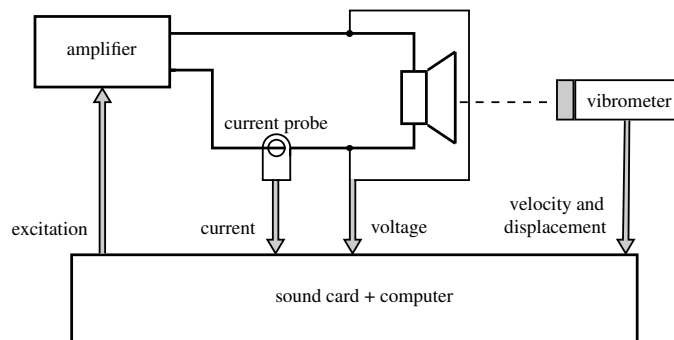

Figure 1: Block schema of the measurement of motor parameters.

current, temperature and frequency may usually be neglected in comparison with the variation with displacement. The resistance  $R_e$  varies with temperature [14], frequency [15] and may also vary with current. The inductance term  $L_e$  is more complicated due to the presence of eddy currents in the pole piece and because its dependence on displacement, current, temperature and frequency [13, 16]. In the following, an experimental setup allowing the measurement of the motor parameters and their variations is presented.

## 3 Experimental Bench

The experimental setup for the measurement of motor parameters is depicted in Fig. 1. The setup allows measuring the current through and the voltage across the loudspeaker in order to estimate very precisely the electrical impedance.

The generation and acquisition of signals are carried out by a Sound card RME Fireface 400, with sampling frequency 192 kHz, dynamic range of 110 dB (RMS unweighted) and total harmonic distortion less than 0.001 %. Before driving the loudspeaker, the excitation signal is amplified using Devialet D-Premier amplifier, with signal to noise ratio 130 dB unweighted and total harmonic distortion at full power (240 W) less than 0.001 %. This equipment ensures a high precision measurement.

To measure the current, a Current Probe Fluke i50s with insertion impedance lower than 10 m $\Omega$  within the audible bandwidth is used. In addition, a single-point vibrometer Polytec (OFV-503, OFV-505) is used to make non contact measurement of the diaphragm vibrations. The vibration measurement allows to estimate the force factor  $Bl$ .

## 4 Force Factor Measurement

In this paper, we assume the force factor  $Bl$  varies only with voice-coil displacement. Its variations with current, temperature and frequency are considered negligible.

In order to measure the variation of the force factor  $Bl$  with voice-coil displacement  $z$ , we displace the voice-coil electrically from its rest position using a dc current and we drive the loudspeaker with a low level signal, considering a small voice-coil displacement around its steady position  $z_i$ . Current  $i(t)$  and voltage  $u(t)$  are measured using the experimental setup described in the previous section. In addition, the velocity  $v(t)$  is measured using a single-point vibrometer allowing the estimation of the force factor  $Bl$  [17]. This procedure is repeated for different static voice-coil displacements  $z_i$ .

## 5 Resistance and Inductance Measurements

The resistance  $R_e$  and the inductance  $L_e$  of the voice-coil may vary with several parameters, such as frequency, input current, voice-coil displacement, etc. In order to separate these variations from each other, the following measurement process is applied.

First, the voice-coil is blocked mechanically in a given position  $z_i$  in order to avoid any voice-coil displacement. Thus,  $z(t)$  from Eq. (1) is kept  $z(t) = z_i$  during the measurement, leading to  $\frac{dz(t)}{dt} = 0$ . Next, a synchronized swept-sine signal [18] is fed to the loudspeaker and the current  $i(t)$  and the voltage  $u(t)$  are measured. Before entering the loudspeaker, the swept-sine signal is filtered in a linear way (FIR filter) in order to keep the effective value of the measured current  $i(t)$  constant for all frequencies.

Several measurements with different excitation levels are made in order to estimate the dependence on the effective value  $I_{eff}$  of current  $i(t)$ .

Next, the voice-coil is blocked mechanically in another position and the procedure is repeated with the same set of values of  $I_{eff}$ . Thus, the current  $i(t)$  and the voltage  $u(t)$  are measured for different positions and different levels of current independently.

The electric impedance defined as

$$Z_e(f) = \frac{U(f)}{I(f)}, \quad (2)$$

is calculated for all the measured data.  $U(f)$  and  $I(f)$  are obtained as the first harmonic product, extracting the higher harmonics<sup>1</sup> using the nonlinear convolution procedure [19]. Resistance  $R_e$  and Inductance  $L_e$  are then estimated from

$$Z_e(f) = R_e(f) + j2\pi fL_e(f). \quad (3)$$

<sup>1</sup>Note, that neglecting the higher harmonics in order to keep the impedance definition valid (in other words considering that the system under test is linear) is incorrect and may lead to misinterpreting the results. Nevertheless, the goal of this paper is not to find the exact variation of loudspeaker parameters, but to show that the parameters vary less using the magnet-only motor, in the way they are usually interpreted.

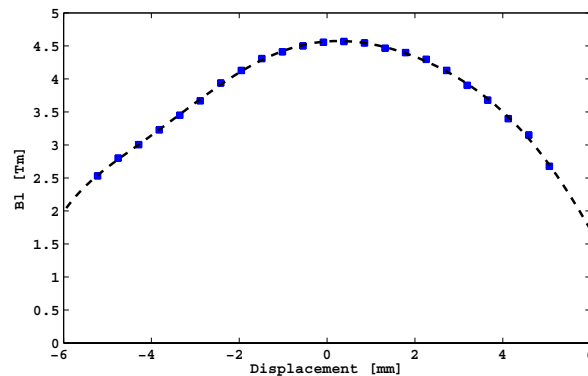

Figure 2: Traditional loudspeaker: Force factor  $Bl$  as a function of voice-coil displacement (measured data - dots, fit curve - dashed).

## 6 Results

Two loudspeakers are measured. The first one is a classical commercial electrodynamic middle-cost loudspeaker. The second one is a prototype of a magnet-only loudspeaker developed in collaboration between Orkidia Audio S.A.R.L and Université du Maine. Both loudspeakers have a 4 inches diameter diaphragm. Their maximal voice-coil displacement at full power and their frequency range are close each other. The aim is not to compare the performance of both loudspeakers, but to highlight the different behaviors due to different principles and to verify the theory of magnet-only loudspeakers that predicts less variation of all mentioned parameters.

### 6.1 Traditional Loudspeaker

The force factor  $Bl$  is measured as a function of voice-coil displacement, as described above. Fig. 2 shows the variation of the force factor  $Bl$  in the case of the traditional loudspeaker. The maximal value  $Bl = 4.5$  Tm lies near the rest position. The force factor  $Bl$  falls rapidly as the voice-coil moves away from its rest position. For a voice-coil displacement of  $\pm 5$  mm, the  $Bl$  value falls almost to half the maximal value.

In Figs. 3 and 4 resistance  $R_e$  and inductance  $L_e$  are depicted as a function of frequency in the case of the traditional loudspeaker. The voice-coil is blocked in its rest position  $z_i = 0$  and the measurement is made for 10 different values of current between 10 mA and 100 mA. Two dependencies are clearly observed on both Figures. The first one is the variation of both resistance  $R_e$  and inductance  $L_e$  with frequency. The resistance  $R_e$  starts at  $5 \Omega$  near the very low frequencies and increases with frequency up to  $25 \Omega$  near 15 kHz. The inductance  $L_e$  decreases from 1.6 mH at low frequencies to 0.6 mH at high frequencies. This variation of both  $R_e$  and  $L_e$  is typical for a traditional electrodynamic loudspeakers [15].

The second dependence observed on Figs. 3 and 4 is the dependence on current for a given frequency. To show this dependence more precisely, both parameters  $R_e$  and  $L_e$  are depicted in Figs. 3 and 4 in a zoom window for a frequency arbitrary fixed to 5 kHz. Both re-

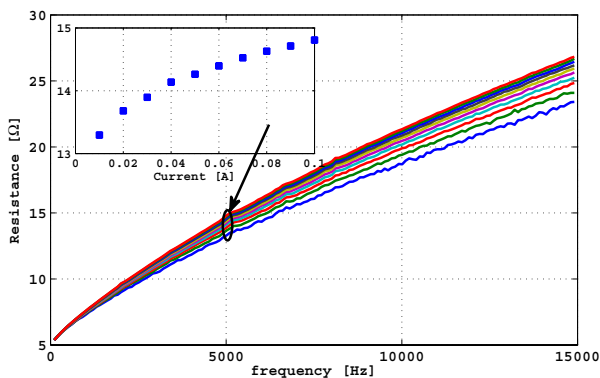

Figure 3: Traditional loudspeaker: Resistance  $R_e$  as a function of frequency. Voice-coil blocked in its rest position  $z_i = 0$ . Resistance is measured for 10 different values of current between 10 mA and 100 mA. Zoom window depicts  $R_e$  as a function of current for frequency 5 kHz.

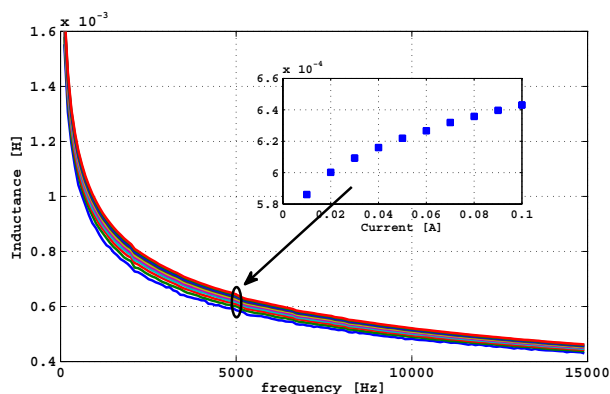

Figure 4: Traditional loudspeaker: Inductance  $L_e$  as a function of frequency. Voice-coil blocked in its rest position  $z_i = 0$ . Inductance is measured for 10 different values of current between 10 mA and 100 mA. Zoom window depicts  $L_e$  as a function of current for frequency 5 kHz.

sistance  $R_e$  and inductance  $L_e$  increase with current. The variation between the values obtained for lowest and highest applied current (10 mA and 100 mA, respectively) is around 10 % for both parameters.

Note that since the current increases, the voice-coil may heat and thus the dependencies on current may be influenced by the variation of temperature. These two effects are not separated in this measurement setup.

In Figs. 5 and 6 the resistance  $R_e$  and inductance  $L_e$  are depicted as a function of frequency for 9 different blocked voice-coil positions  $z_i$  from -4 mm to 4 mm. The effective value of current is kept constant at 50 mA. Here again, the variation of both resistance  $R_e$  and inductance  $L_e$  is obvious. The dependence on voice-coil displacement for a given frequency can also be observed. Fixing the frequency to 5 kHz, (zoom windows of Figs. 5 and 6) shows the variation of both parameters as a function of voice-coil displacement. The variation between the values obtained for lowest and highest voice-coil displacement (-4 mm and 4 mm, respectively) is around 10 % for both parameters.

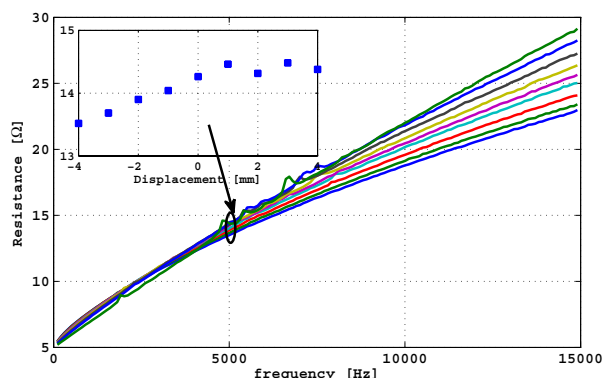

Figure 5: Traditional loudspeaker: Resistance  $R_e$  as a function of frequency. Resistance is measured for 9 different blocked voice-coil positions  $z_i$  from -4 mm to 4 mm. The effective value of current is kept constant (50 mA). Zoom window depicts  $R_e$  as a function of voice-coil displacement for frequency 5 kHz.

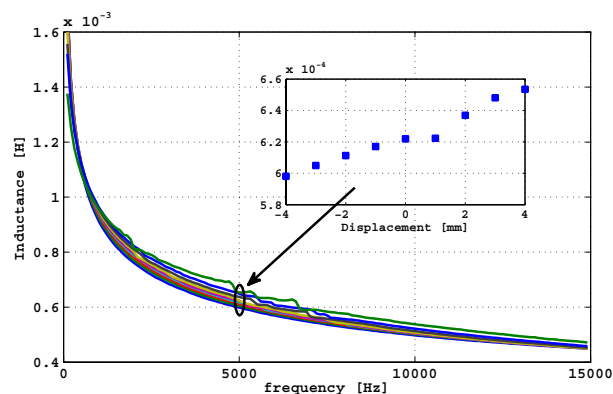

Figure 6: Traditional loudspeaker: Inductance  $L_e$  as a function of frequency. Inductance is measured for 9 different blocked voice-coil positions  $z_i$  from -4 mm to 4 mm. The effective value of current is kept constant (50 mA). Zoom window depicts  $L_e$  as a function of voice-coil displacement for frequency 5 kHz.

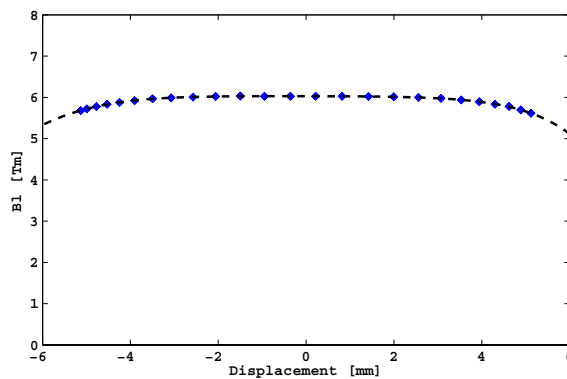

Figure 7: Magnet-only loudspeaker: Force factor  $Bl$  as a function of voice-coil displacement (measured data - dots, fit curve - dashed).

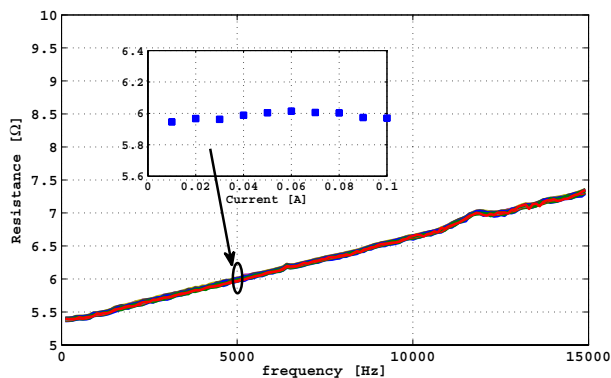

Figure 8: Magnet-only loudspeaker: Resistance  $R_e$  as a function of frequency. Voice-coil blocked in its rest position  $z_i = 0$ . Resistance is measured for 10 different values of current between 10 mA and 100 mA. Zoom window depicts  $R_e$  as a function of current for frequency 5 kHz.

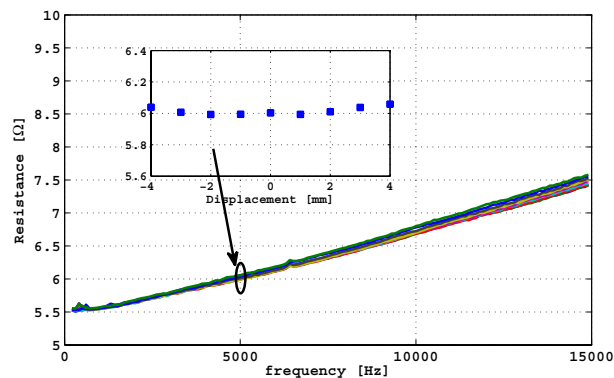

Figure 10: Magnet-only loudspeaker: Resistance  $R_e$  as a function of frequency. Resistance is measured for 9 different blocked voice-coil positions  $z_i$  from  $-4$  mm to 4 mm. The effective value of current is kept constant (50 mA). Zoom window depicts  $R_e$  as a function of voice-coil displacement for frequency 5 kHz.

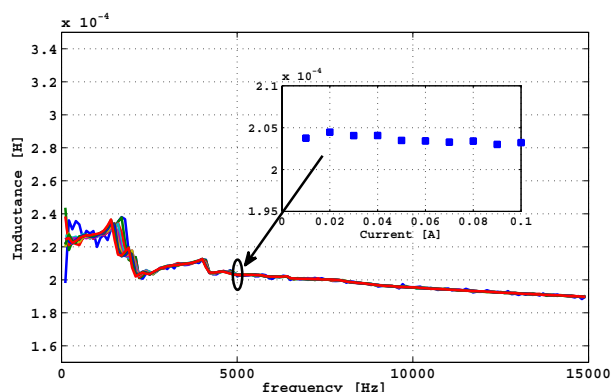

Figure 9: Magnet-only loudspeaker: Inductance  $L_e$  as a function of frequency. Voice-coil blocked in its rest position  $z_i = 0$ . Inductance is measured for 10 different values of current between 10 mA and 100 mA. Zoom window depicts  $L_e$  as a function of current for frequency 5 kHz.

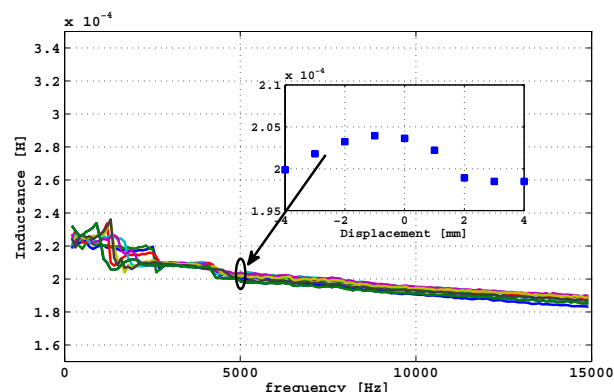

Figure 11: Magnet-only loudspeaker: Inductance  $L_e$  as a function of frequency. Inductance is measured for 9 different blocked voice-coil positions  $z_i$  from  $-4$  mm to 4 mm. The effective value of current is kept constant (50 mA). Zoom window depicts  $L_e$  as a function of voice-coil displacement for frequency 5 kHz.

## 6.2 Magnet-only Loudspeaker

Fig. 7 shows the force factor  $Bl$  of the magnet-only loudspeaker. The magnet-only loudspeaker exhibits a constant force factor  $Bl \simeq 6$  Tm up to a voice-coil displacement of about 4.0 mm. For a voice-coil displacement of  $\pm 5$  mm the force factor  $Bl$  decreases to 93 % of its maximal value.

In Figs. 8 and 9, the resistance  $R_e$  and inductance  $L_e$  are depicted as a function of frequency when the voice-coil is blocked in its rest position  $z_i = 0$ . The measurement is made for 10 different values of current between 10 mA and 100 mA. Both parameters  $R_e$  and  $L_e$  are still frequency dependent, but compared to the traditional loudspeaker, the variation is much lower. The resistance  $R_e$  starts at 5  $\Omega$  near the very low frequencies and increases with frequency to 8  $\Omega$  near 15 kHz. The inductance  $L_e$  decreases from 0.24 mH at low frequencies to 0.19 mH at high frequencies.

It is also obvious that the dependence on current

is almost negligible (the zoom windows of Figs. 8 and 9). There is almost no variation in resistance  $R_e$  nor in inductance  $L_e$ . The noisy results at low frequency in case of the inductance  $L_e$  (Fig. 9) is due to non-perfect mechanical fixation of the voice-coil. Note that even if the current increases and the voice-coil may heat, no temperature influence is observed.

In Figs. 10 and 11 the resistance  $R_e$  and inductance  $L_e$  are depicted as a function of frequency for 9 different blocked voice-coil positions  $z_i$  from -4 mm to 4 mm. The effective value of current is kept constant at 50 mA. A very small dependence on voice-coil displacement can be observed. In the case of resistance  $R_e$  the value is almost constant. In the case of inductance  $L_e$  a dependence is observed, but very small in comparison to the case of the traditional loudspeaker.

## 7 Conclusion

The goal of this paper was to experimentally verify the theory of magnet-only loudspeaker. The analytical studies presented lately [8, 9, 10] predict an important increase of linearity due to almost constant motor parameters.

Two loudspeakers have been compared, a traditional commercial electrodynamic middle-cost one and a prototype of a magnet-only loudspeaker made in collaboration between Orkidia Audio S.A.R.L and Université du Maine.

First, the parameters of the traditional loudspeaker have been measured to show their variations with frequency, voice-coil displacement and current. The variations of these parameters may depend on the actual loudspeaker, but they are always observed [13]. It is shown that the variation of resistance  $R_e$  and inductance  $L_e$  is mostly caused by the presence of iron in traditional loudspeaker.

Then, the parameters of the magnet-only loudspeaker have been measured. All motor parameters (force factor  $Bl$ , resistance  $R_e$  and inductance  $L_e$ ) have shown almost no dependence on all the physical variables. This leads to an increase of the linearity of the loudspeaker, usually correlated with increase of sound quality during the reproduction [20].

## References

- [1] W. House, "Transducer Motor Assembly", US Patent 5,142,260 (1992)
- [2] S. Geinseberger and G. Krump, "Loudspeaker Having Radially Magnetized Ring", US Patent 6,359,997 (2002)
- [3] Y. Ohashi, "Magnetic Circuit and Speaker", Patent EP 1,553,802 A2 (2005)
- [4] B. Richoux, G. Lemarquand and V. Lemarquand, "Transducteur Électrodynamique, applications aux haut-parleurs et Géophones", PCT/FR2006/051133, 2005
- [5] G. Lemarquand, "New Structure of Loudspeaker", *Audio Eng. Soc. 120th Convention*, Paris, France, May 2006
- [6] M. Remy, G. Lemarquand, D. Ceruti, G. Guyader, R. Toppi and M.-F. Six, "Ironless Motor Loudspeaker: Quantization of the Subjective Enhanced Sound Quality", *Audio Eng. Soc. 120th Convention*, San Francisco, USA, November 2010
- [7] G. Lemarquand, "Ironless Loudspeakers", *IEEE Trans. Magn.*, **43**, 3371-3374 (2007)
- [8] B. Merit, G. Lemarquand and B. Nemoff, "An Ironless Low Frequency Subwoofer Functioning under Its Resonance Frequency", *Audio Eng. Soc. 125th Convention*, San Francisco, USA, October 2008
- [9] B. Merit, G. Lemarquand and V. Lemarquand, "In Pursuit of Increasingly Linear Loudspeaker Motors", *IEEE Trans. Magn.*, **45**, 2867-2870 (2009)
- [10] B. Merit, "Contribution to the Identification of the Electrodynamical Loudspeaker Motors Nonlinearities - On the Realization of Magnet-Only Motors" (*in french*), Ph.D. Thesis, LAUM, University of Maine, France, (2010)
- [11] G. Lemarquand and B. Merit "Magnetic structure for an ironless electrodynamic-loudspeaker motor, motors", US Patent US 2010/0172534 A1 (2010)
- [12] A.N. Thiele, "Loudspeakers in vented boxes", *I.R.E. Radio and Electronic Engineering Convention*, Proceedings of the IRE Australia, March 1961
- [13] W. Klippel, "Tutorial: Loudspeaker Non Linearities - Symptoms, Parameters, Causes", *J. Audio Eng. Soc.*, **54**, 907-939 (2006)
- [14] C.A. Henricksen, "Heat Transfer Mechanisms in Loudspeakers: Analysis, Measurement and Design," *J. Audio Eng. Soc.*, **35**(10), 778-791 (1987)
- [15] J. Vanderkooy, "A model of loudspeaker driver impedance incorporating eddy currents in the pole structure", *J. Audio Eng. Soc.*, **37**(3), 119-128 (1989)
- [16] I. Schafer and K. Kruger "Modelling of coils using fractional derivatives." *J. Magn. Magn. Mater.*, **307**(1), 91-98 (2006)
- [17] J.N. Moreno "Measurement of Loudspeaker Parameters Using a Laser Velocity Transducer and Two-Channel FFT Analysis" *J. Audio Eng. Soc.*, **39**(4), 243-249 (1991)
- [18] A. Novak, L. Simon, F. Kadlec and P. Lotton, "Nonlinear System Identification Using Exponential Swept-Sine Signal", *IEEE Trans. Instrum. Meas.*, **59**, 2220-2229 (2010)
- [19] A. Farina, "Simultaneous Measurement of Impulse Response and Distortion with a Swept-Sine Technique", *Audio Eng. Soc. 108th Convention*, Paris, France, February 2000
- [20] L.W. Lee and E.R. Geddes "Auditory perception of nonlinear distortion", *Audio Eng. Soc. 115th Convention*, New York, USA, October 2003